

### AGYA009GCGH

Please visit our webstore for full product and technical documentation 

Unit Type	Compact Floor (Internal EEV)
Remote Controller	Option
Nominal Cooling Capacity (kW)	2.8
UK Total Cooling Capacity (kW)	2.1
UK Sensible Cooling Capacity (kW)	1.7
Nominal Heating Capacity (kW)	3.0
UK Heating Capacity (kW)	3.2
Height (mm)	600
Width (mm)	740
Depth (mm)	200
Weight (kg)	15
Airflow Rate - Cooling - High (m3/h)	500
Sound Pressure Level - Cooling - High (dB(A))	38
Sound Pressure Level - Cooling - Low (dB(A))	39
Refrigerant Type (Global Warming Potential)	R410A (2,088)
Liquid Pipe Size	1/4"
Gas Pipe Size	3/8"
Unit Power Supply	1Ph-230V-50Hz



#### Document Downloads

[Air Distribution](#)

[Airflow](#)

[Cooling Capacity](#)

[Dimensional Drawing](#)

[Electrical Characteristics](#)

[Heating Capacity](#)

[Installation Manual](#)

[Noise Curve](#)

[Operation Manual](#)

[Product Image](#)

[Spare Parts List All Pages](#)

[Specifications](#)

[Wiring Diagram](#)

#### Related Items

[UTYRNRZ5](#)

[UTYRCRYZ1](#)

[UTYRSRY](#)

[UTYRHHY](#)

[UTYLNHY](#)

[UTYTF5XZ1](#)

Touch Screen Remote Controller

Compact Simple Remote controller

Simple Remote Controller (with Master Control)

Simple Remote Controller (without Master Control)

Wireless Remote Controller

Wireless LAN interface

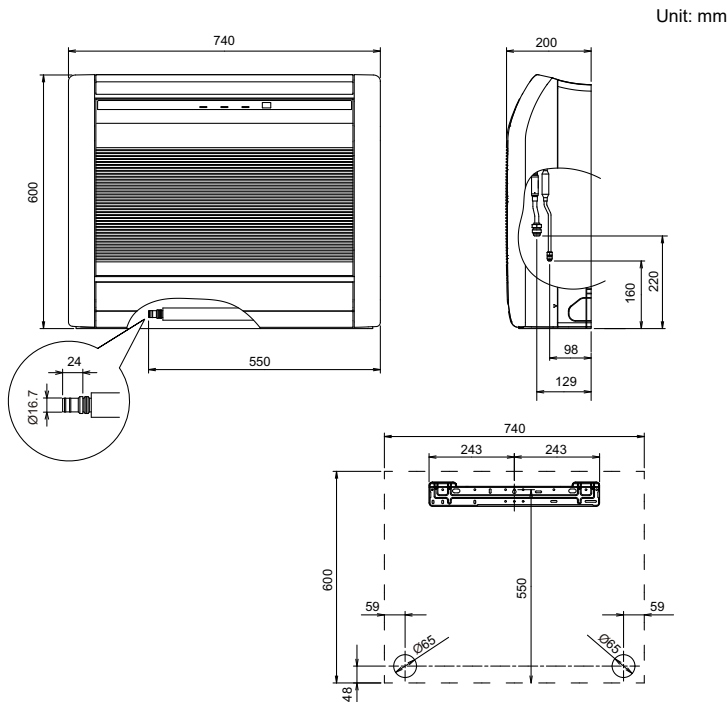

\*Specifications and design are subject to change without notice for further improvement.

\*Actual products' colors may be different from the colors shown in this printed material.

Distributed by :

**FUJITSU GENERAL AIR CONDITIONING (UK) LIMITED**  
Unit 150, Centennial Park, Centennial Avenue, Elstree, Borehamwood, Herts, WD6 3SG

[www.fujitsu-general.com/uk](http://www.fujitsu-general.com/uk)

[sales@fgac.fujitsu-general.com](mailto:sales@fgac.fujitsu-general.com)

Tel: +44 (0) 208 731 3450 Fax: +44 (0) 208 731 3451