

8. External input and output

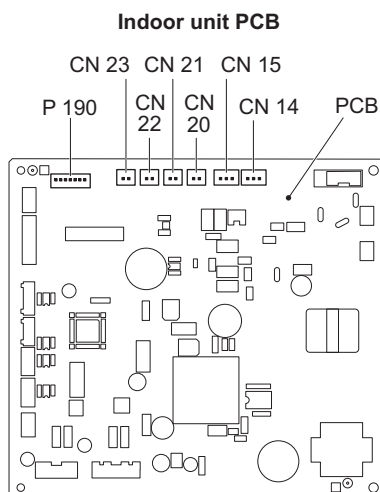

PCB	External input	External output	Connector	Input signal
Indoor unit	Operation/Stop	—	CN14	Edge
	Forced stop		CN15	
	Forced thermostat off			
	—	Operation status	CN20/CN21/ CN22/CN23	—
	Error status			
	Indoor unit fan operation status			
	External heater output			

8-1. External input

- “Operation/Stop” mode or “Forced stop” mode can be selected with function setting of indoor unit.
- A twisted pair cable (22AWG) should be used. Maximum length of cable is 150 m.
- The wire connection should be separate from the power cable line.

■ Indoor unit

Indoor unit functions such as Operation/Stop can be done by using indoor unit connectors.

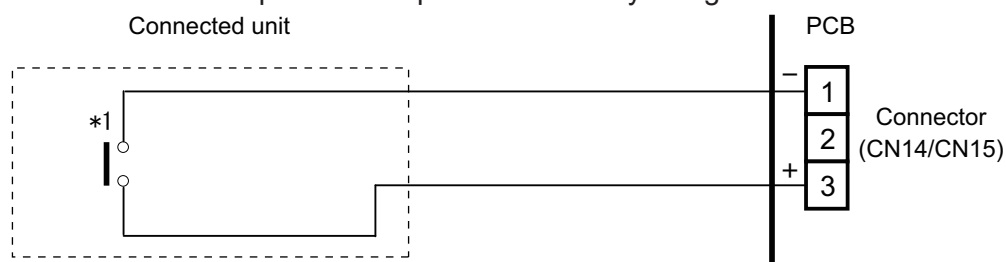

*1: The switch can be used on the following condition: DC 12 V to 24 V, 1 mA to 15 mA.

8-2. External output

Use an external output cable with appropriate external dimension, depending on the number of cables to be installed.

■ Indoor unit

- A twisted pair cable (22AWG) should be used. Maximum length of cable is 25 m .
- Output voltage: High DC 12 V \pm 2 V, Low 0 V.
- Permissible current: 50 mA
- For details, refer to Chapter 8-3. "[Combination of external input and output](#)" on page 17.

● When indicator or other components are connected directly

Example: Function setting 60 is set to "00"

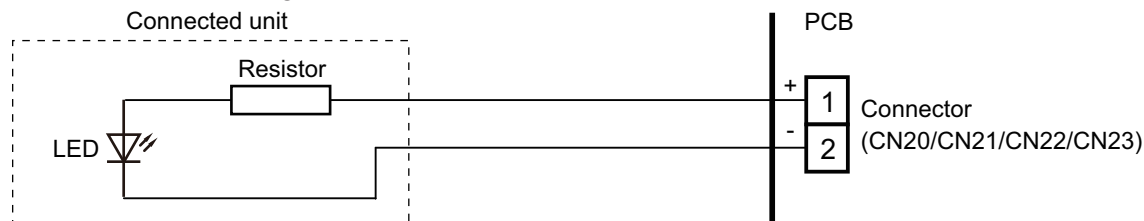

● When connecting with a device equipped with a power supply

Example: Function setting 60 is set to "00"

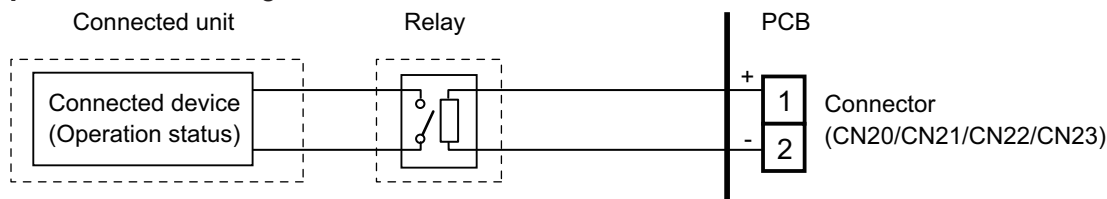

8-3. Combination of external input and output

By combining the function setting of the indoor unit, you can select various combinations of functions.

Combination examples of external input and output are as follows:

Mode	Function setting	External input	
		Indoor unit	
		CN14	CN15
0	60-00	Operation/Stop (Function setting 46-00) or Forced stop (Function setting 46-02)	Forced thermostat Off
9	60-09		Forced thermostat Off
10	60-10		Forced thermostat Off
11	60-11		Forced thermostat Off
12	60-12		Forced thermostat Off

Mode	Function setting	External output			
		Indoor unit			
		CN20	CN21	CN22	CN23
0	60-00	Operation/Stop	Error status	Indoor unit fan operation status	External heater output
9	60-09	Error status	Operation/Stop	Indoor unit fan operation status	External heater output
10	60-10	Indoor unit fan operation status	Operation/Stop	Error status	External heater output
11	60-11	External heater output	Operation/Stop	Indoor unit fan operation status	Error status

NOTE: Input of Operation/Stop depends on the setting of function setting 46.

00: Operation/Stop mode 1 (R.C. enabled)

01: (Setting prohibited)

02: Forced stop

03: Operation/Stop mode 2 (R.C. disabled)

Input signal type

Indoor unit

Input signal type is only "Edge".

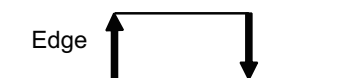

8-4. Details of function

■ Control input function

● When function setting is "Operation/Stop" mode 1

- In the case of "Edge" input

Mode	Function setting		External input	Input signal	Command	
0	46-00	—	Input of indoor unit	CN14	Off → On	Operation
					On → Off	Stop
	60-00	—		CN15	Off → On	Operation
					On → Off	Stop

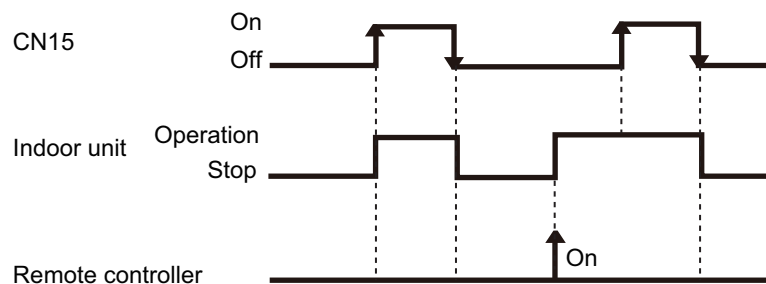

● When function setting is "Forced stop" mode

- In the case of "Edge" input

Mode	Function setting		External input	Input signal	Command	
0	46-02	—	Input of indoor unit	CN14	Off → On	Forced stop
					On → Off	Normal
	60-00	—		CN15	Off → On	Forced stop
					On → Off	Normal

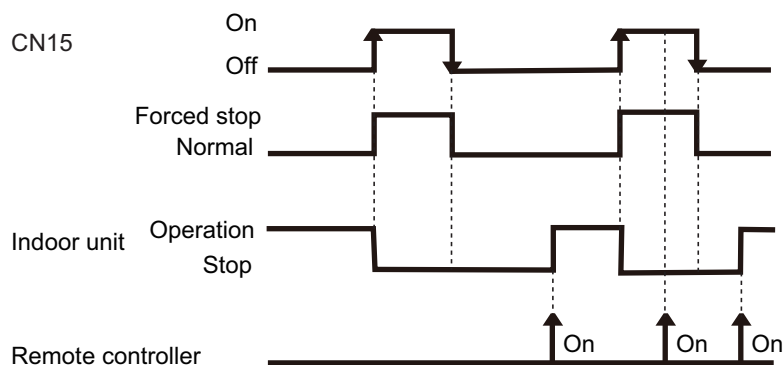

● When function setting is "Operation/Stop" mode 2

- In the case of "Edge" input

Mode	Function setting		External input		Input signal	Command
0	46-03	—	Input of indoor unit	CN14	Off → On	Operation
					On → Off	Stop (R.C. disabled)
	60-00	CN15		Off → On	Operation	
				On → Off	Stop (R.C. disabled)	

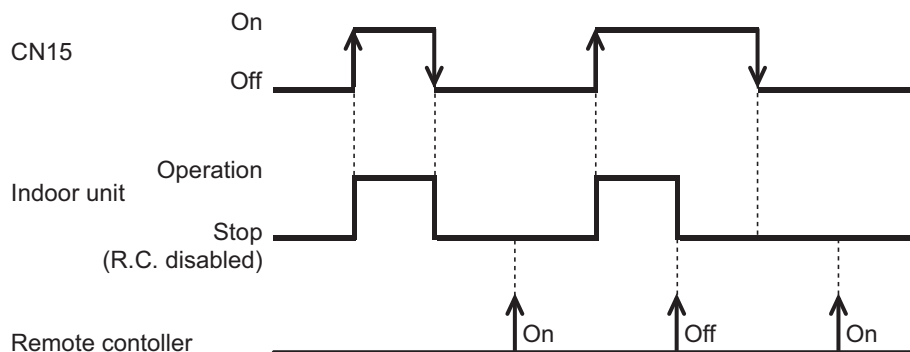

● Forced thermostat off function

Mode	Function setting		External input		Input signal	Command
0	60-00		Input of indoor unit	CN15	Off → On	Thermostat off
9	60-09				On → Off	Normal operation
10	60-10					

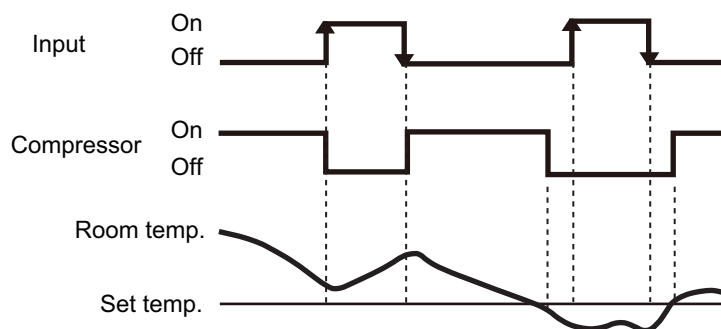

● Example of individual connection

Forced thermostat off is one of the function to save energy. For example, case of using ventilator at condition with outdoor temperature is lower than indoor temperature, indoor unit of air conditioner stop based upon receiving signal from external controller. (Cooling only)

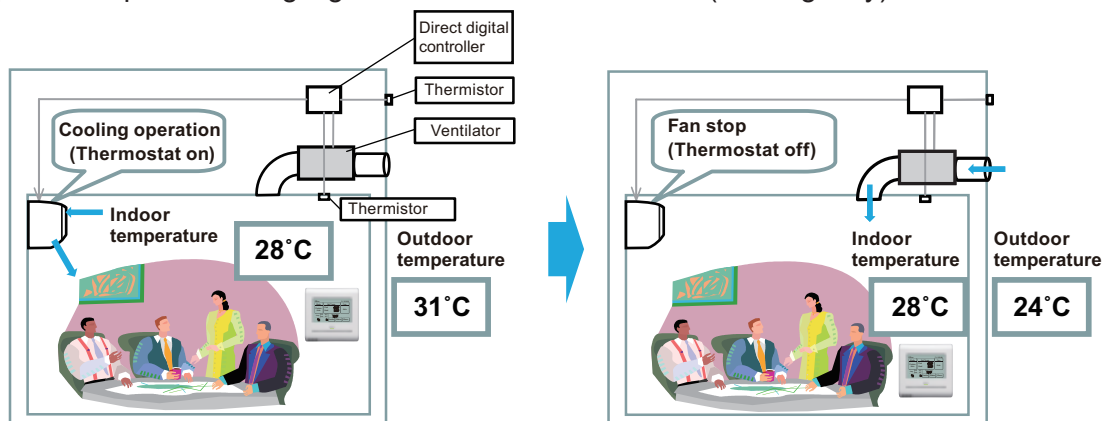

• System figure example

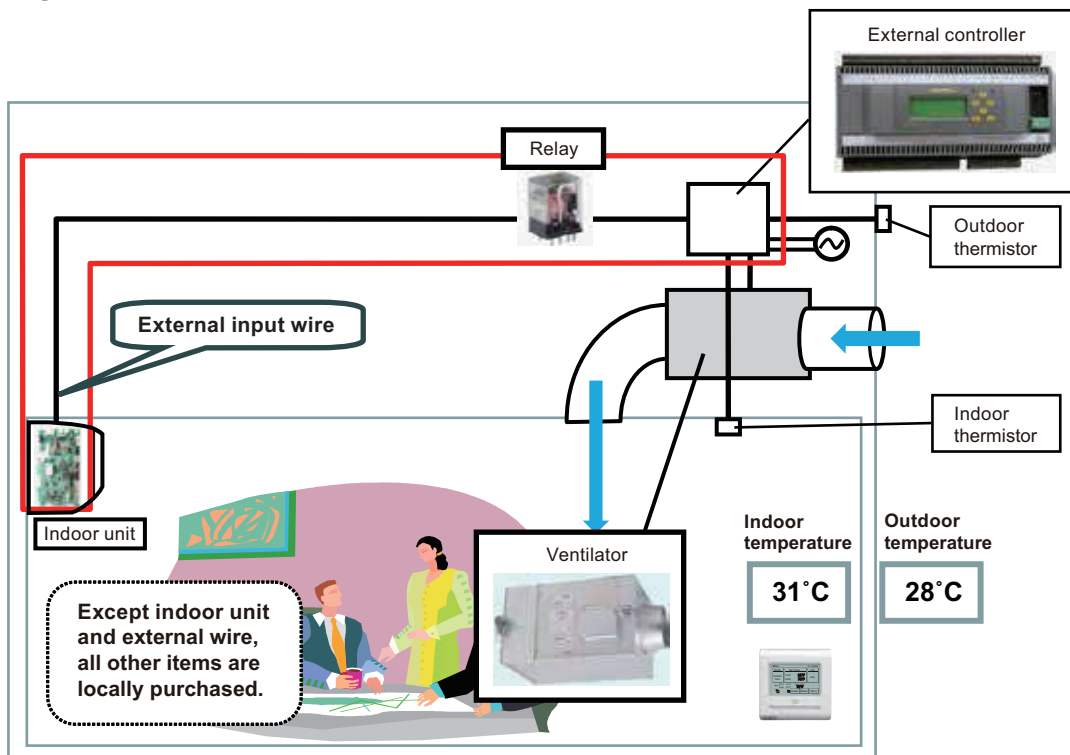

• Operation status

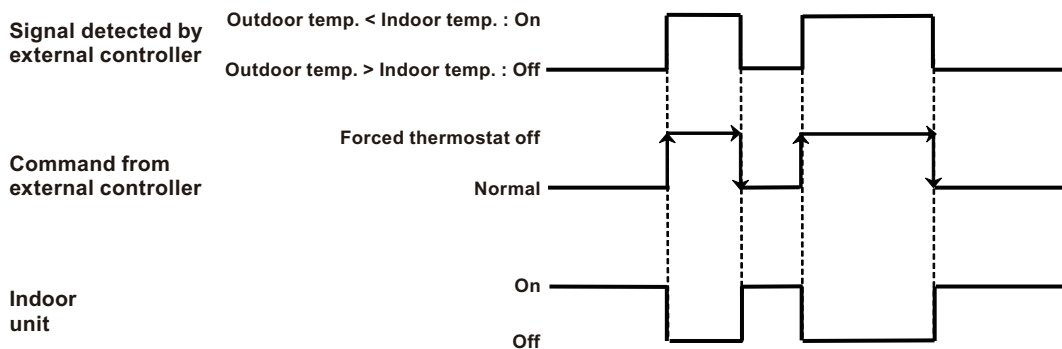

Normal means that indoor unit continues to operate until “Forced thermostat Off” signal received, at condition which are set by central and individual controller or detected by thermo sensors of indoor unit.

Indoor unit continues to operate until “Forced thermostat Off” signal received, at condition which are set by central and individual controller or detected by thermo sensors of indoor unit. Once “Forced thermostat Off” signal received, indoor unit stop operation.

■ Control output function

● Operation/Stop status

Mode	Function setting	External output		Output signal	Command
0	60-00	Output of indoor unit	CN15	Low → High	Operation
				High → Low	Stop
CN20	Off → On		Operation		
	On → Off		Stop		
0	60-00				

The output is low when the unit is stopped.

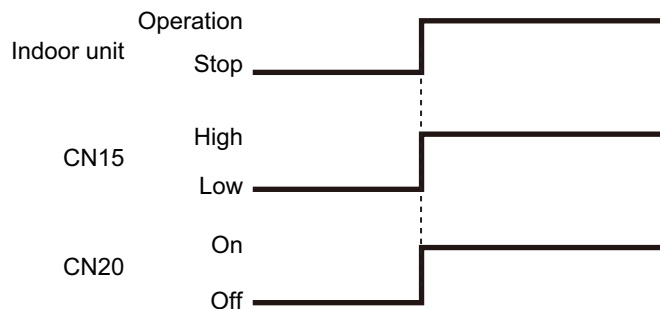

● Error status

Mode	Function setting	External output		Output signal	Command
9	60-09	Output of indoor unit	CN15	Low → High	Error
				High → Low	Normal
CN21	Off → On		Error		
	On → Off		Normal		
0	60-00				

The output is ON when an error is generated for the indoor unit.

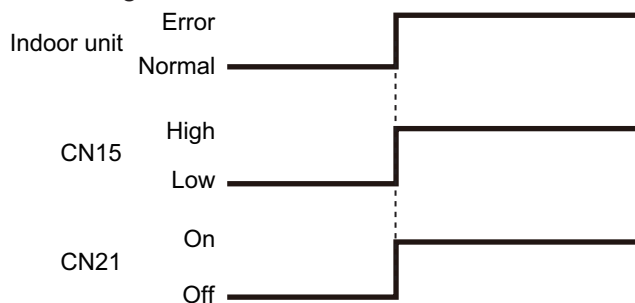

● Indoor unit fan operation status

Mode	Function setting	External output		Output signal	Command
10	60-10	Output of indoor unit	CN15	Low → High	Fan run
				High → Low	Fan stop
0	60-00		CN22	Off → On	Fan run
				On → Off	Fan stop

Output signal	Condition
On Low → High	The indoor unit fan is operating.
Off High → Low	The fan is stopped or during cold air prevention. During thermostat off when in dry mode operation.

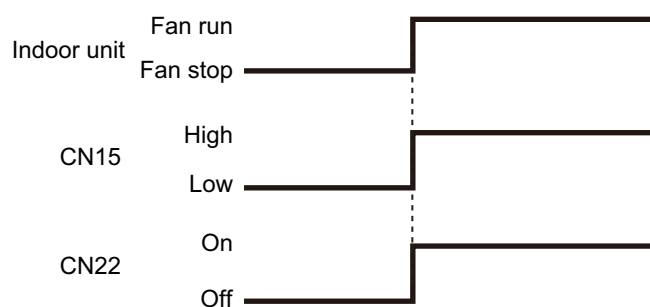

External heater output

Control	Primary heater	Auxiliary heater	Function setting
			Indoor unit
			Control switching external heaters No. 61
Auxiliary heater control 1	RAC heat pump	External device (Hot water electrical heater, etc.)	61-00

NOTES:

- After turning off the heater, 3 minutes of standby time is required by next power-on of the heater.
- For items marked “—” in the table, any of validate or invalidate of the setting are acceptable.

Installation configuration of individual connection

External heating device is installed individually. (No use of indoor unit fan)

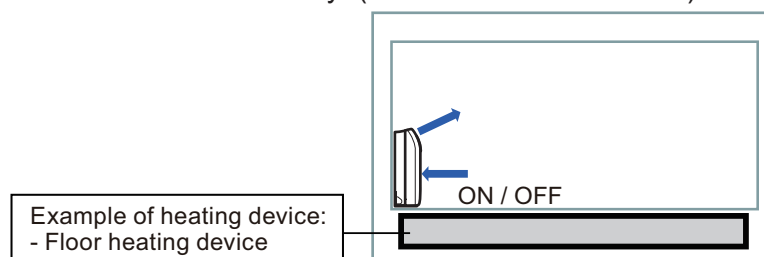

⚠ WARNING

- Design and install external heater appropriately with considering its protection.
- Inappropriate designing and installation of external heater may cause a fire by emitted heat from the external heater.
- Fujitsu General Ltd. is not responsible for inappropriate designing or installation of external heating device.

● Auxiliary heater control 1

Operation	Condition
Heater on	Heater is on as shown in following diagram of heating temperature.
Heater off	<ul style="list-style-type: none"> • Heater is off as shown in following diagram of heating temperature. • Other than heating mode • Error occurred • Forced thermostat off • Fan stop protection

- Temperature of heater on (Thon): Adjustable by function number 62 (Operating temperature switching of external heaters).
- All control temperatures will shift by adjusting “Thon”.

Example: When set temperature (Ts) is 22°C (Factory setting),

- and room temperature (Tr) increases above 12°C, signal output is on.
- and room temperature (Tr) increases above 21°C, signal output is off.
- and room temperature (Tr) decreases below 19°C, signal output is on.
- and room temperature (Tr) decreases below 10°C, signal output is off.