

4. Installation space

⚠ CAUTION

- The installation space shown in the following examples is based on an ambient temperature under cooling operation of 35°CDB at the air intake of the outdoor unit.
Provide more space around the air intake than shown in the examples if the ambient temperature exceeds 35°CDB or if the thermal load of all of the outdoor units exceeds the capacity.
- Consider the transportation route, installation space, maintenance space, and access, and install the unit in a location with sufficient space for the refrigerant piping.
- Observe the installation space specifications that are shown in the figures.
Provide the same space for the air intake at the rear of the outdoor unit.
If the installation is not performed according to the specifications, it could cause a short circuit and result in a lack of operating performance. As a result, the outdoor unit might easily be stopped by high-pressure protection.

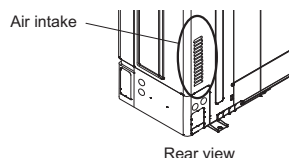

- Installation methods not shown in the following examples are not recommended. Performance may drop significantly.

4-1. Space requirement

Provide sufficient installation space for product safety.

● Single outdoor unit installation

- When the upper space is open:

Unit: mm

When there are obstacles at the rear only.

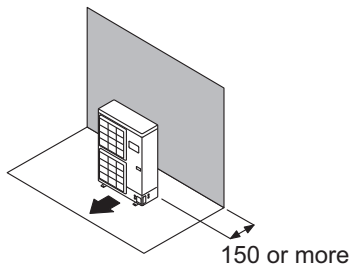

When there are obstacles at the rear and sides.

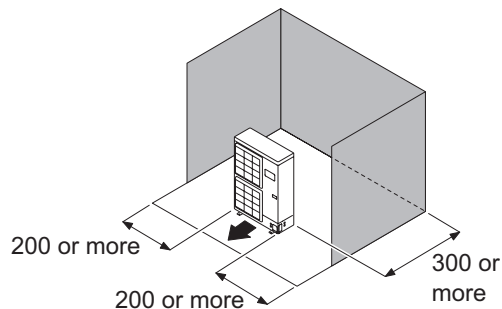

When there are obstacles at the front only.

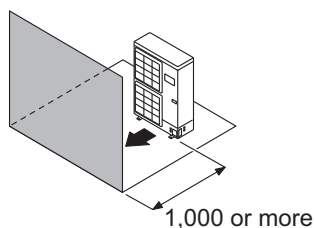

When there are obstacles at the front and rear.

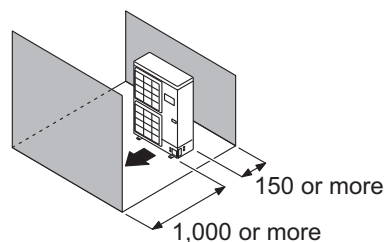

- When there is an obstruction in the upper space:

Unit: mm

When there are obstacles at the rear and above.

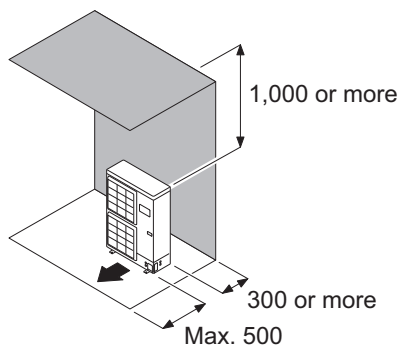

When there are obstacles at the rear, sides, and above.

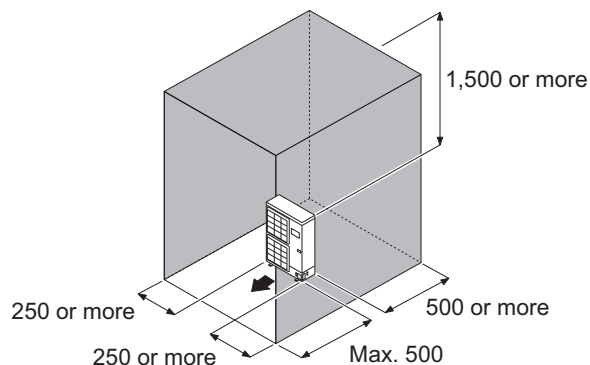

OUTDOOR
UNITS

OUTDOOR
UNITS

● Multiple outdoor unit installation

NOTES:

- Provide at least 25 mm of space between the outdoor units if multiple units are installed.
- When routing the piping from the side of an outdoor unit, provide space for the piping.
- No more than 3 units must be installed side by side.
When 3 units or more are arranged in a line, provide the space as shown in the following example when an obstruction is present also in the upward area.

- **When the upper space is open:**

Unit: mm

When there are obstacles at the rear only.

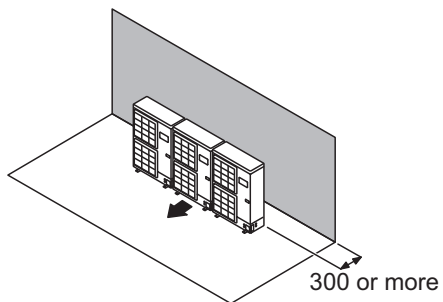

When there are obstacles at the front only.

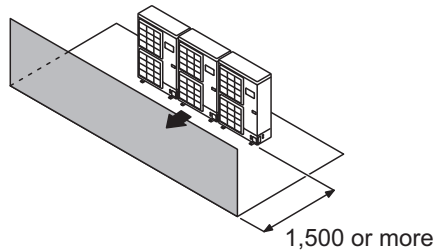

When there are obstacles at the front and rear.

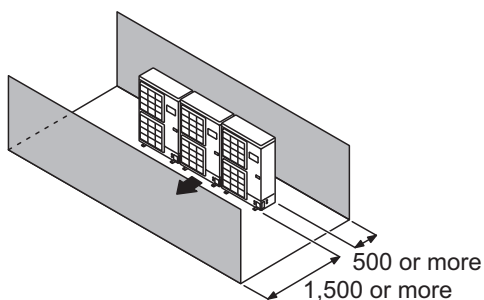

- **When there is an obstruction in the upper space:**

Unit: mm

When there are obstacles at the rear and above.

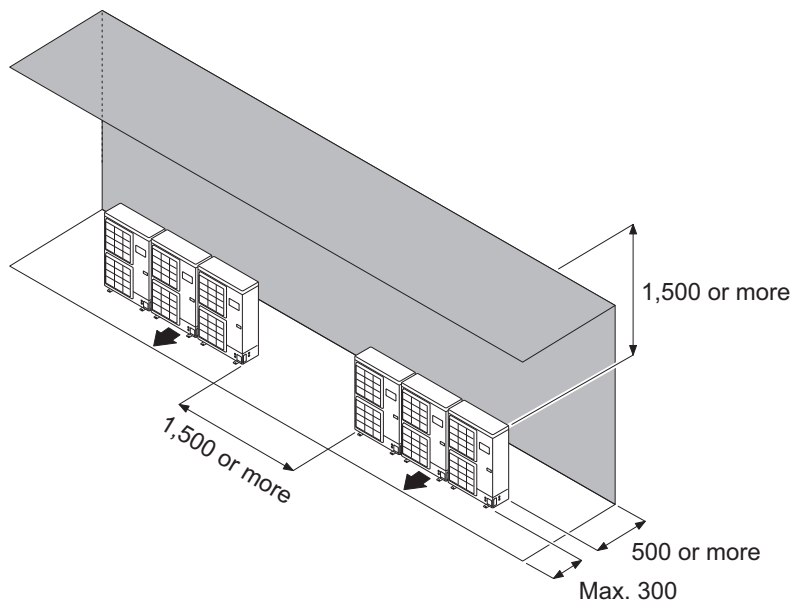

● Outdoor unit installation in multi-row

NOTE: Following settings are not recommended in case of cooling by a low outside temperature.

Unit: mm

Single parallel unit arrangement

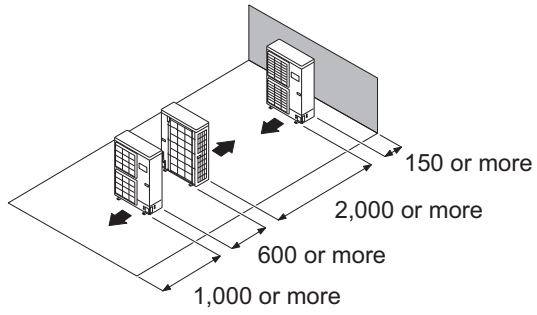

Multiple parallel unit arrangement

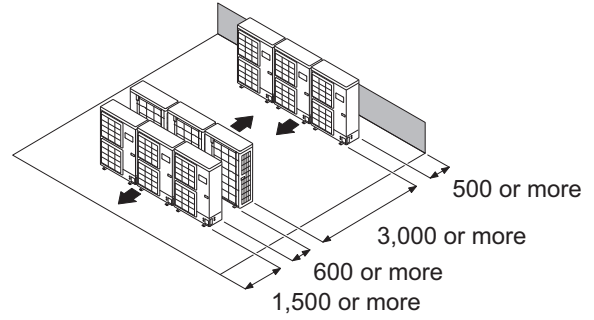

OUTDOOR
UNITS

OUTDOOR
UNITS

4-2. Duct installation

When there is obstacles at rear, and the side walls protruding front ward, install a duct as shown in figure below.

Installation of the unit without duct may lead capacity degradation caused by short circuit, operation stop by high pressure protection, or other malfunction.

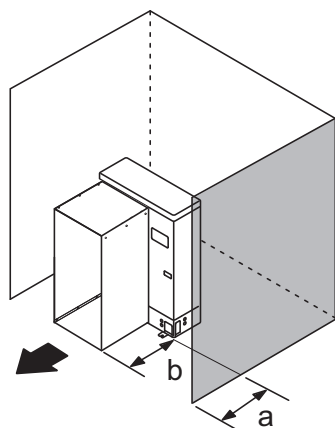

a: Protruding distance of side walls

b: Length of the duct

$a \leq b$

■ About the duct

The duct needs to be purchased locally. When installing the duct, be careful of the followings:

- Do not cover the service panel. If covered, the panel cannot be opened for servicing.
- Screw holes for installing the duct are placed on the front panel. Fix the duct by using a $\varnothing 4$ mm tapping screw. (Refer to following diagram for the location.)

● Models: AJ*040LBDH, AJ*045LBDH, AJ*054LBDH, AJ*040LELDH, AJ*045LELDH, and AJ*054LELDH

Unit: mm

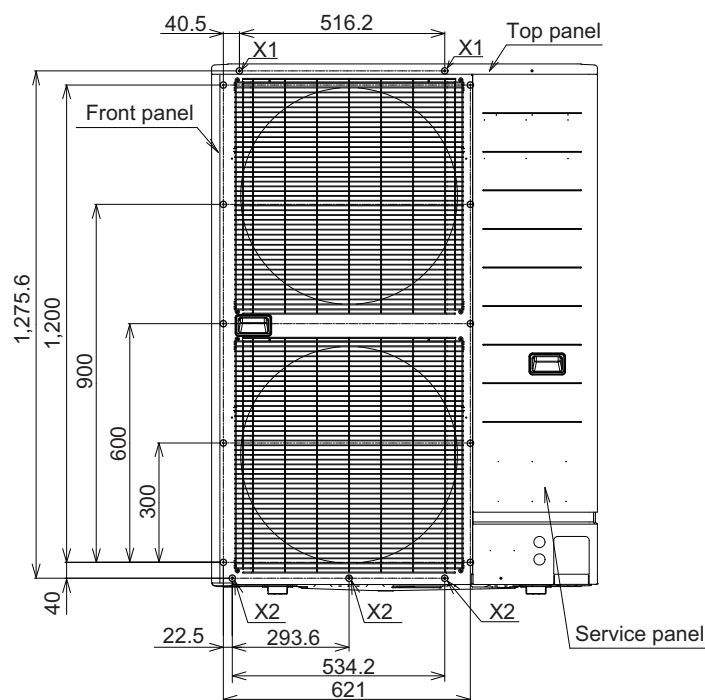

NOTES:

- X1: Remove the screw securing the top panel, and reuse it for fixing the duct.
- X2: Remove the screw securing the front panel, and reuse it for fixing the duct.

■ Duct installation example

- Models: AJ*040LBDH, AJ*045LBDH, AJ*054LBDH, AJ*040LELDH, AJ*045LELDH, and AJ*054LELDH

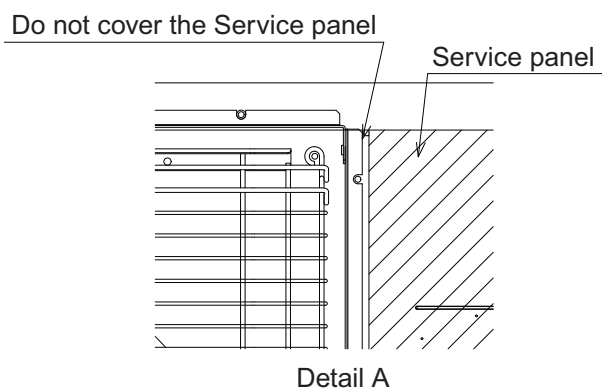
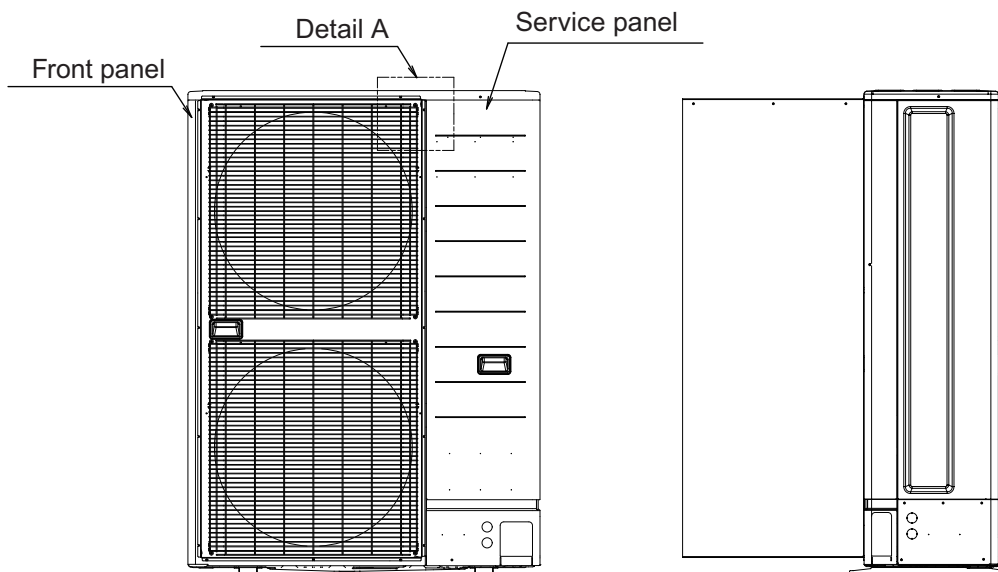

OUTDOOR
UNITS

OUTDOOR
UNITS