

Models : AJ*072GALBH
AJ*090GALBH
AJ*108GALBH

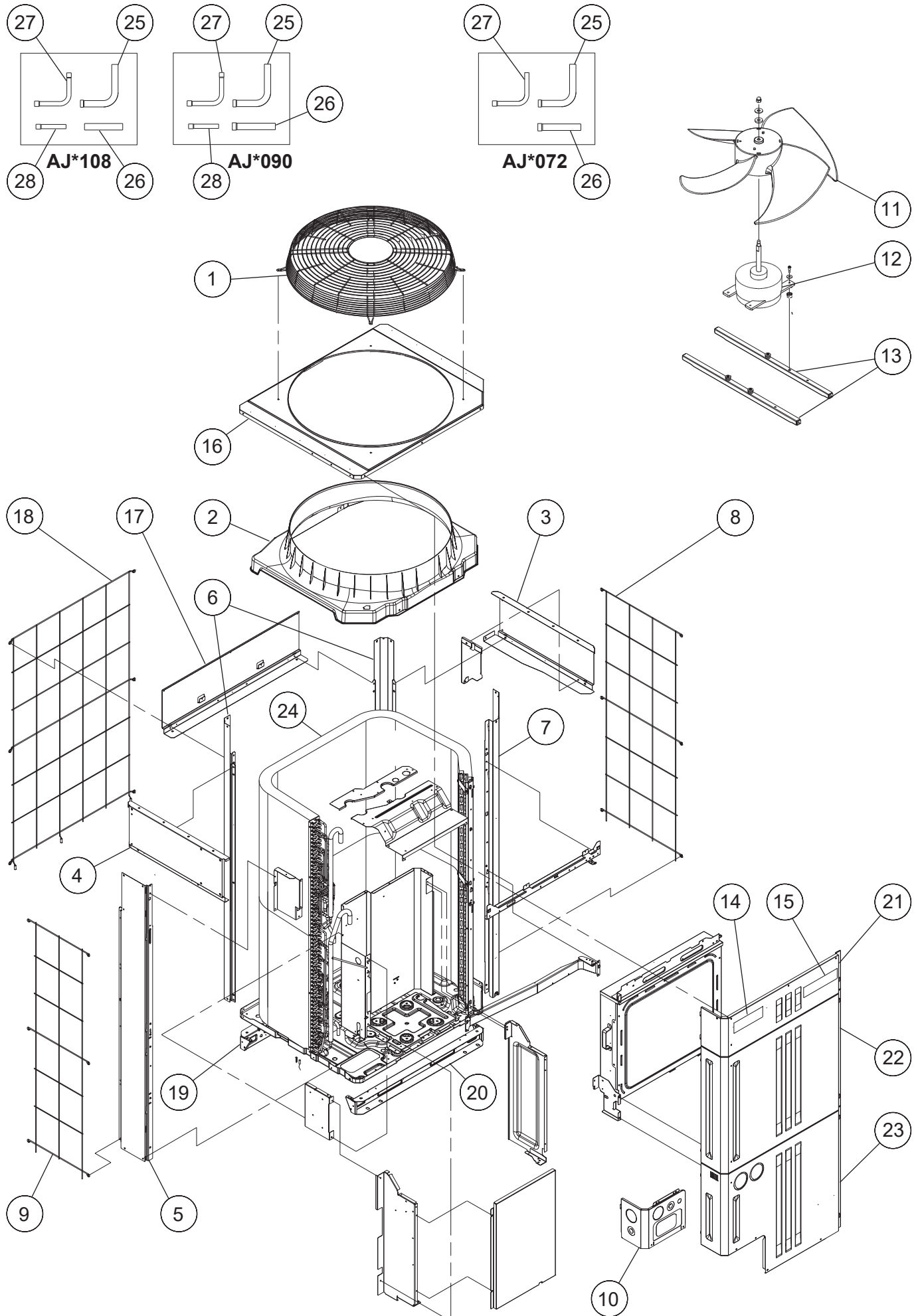

Models : AJ*072GALBH
AJ*090GALBH
AJ*108GALBH

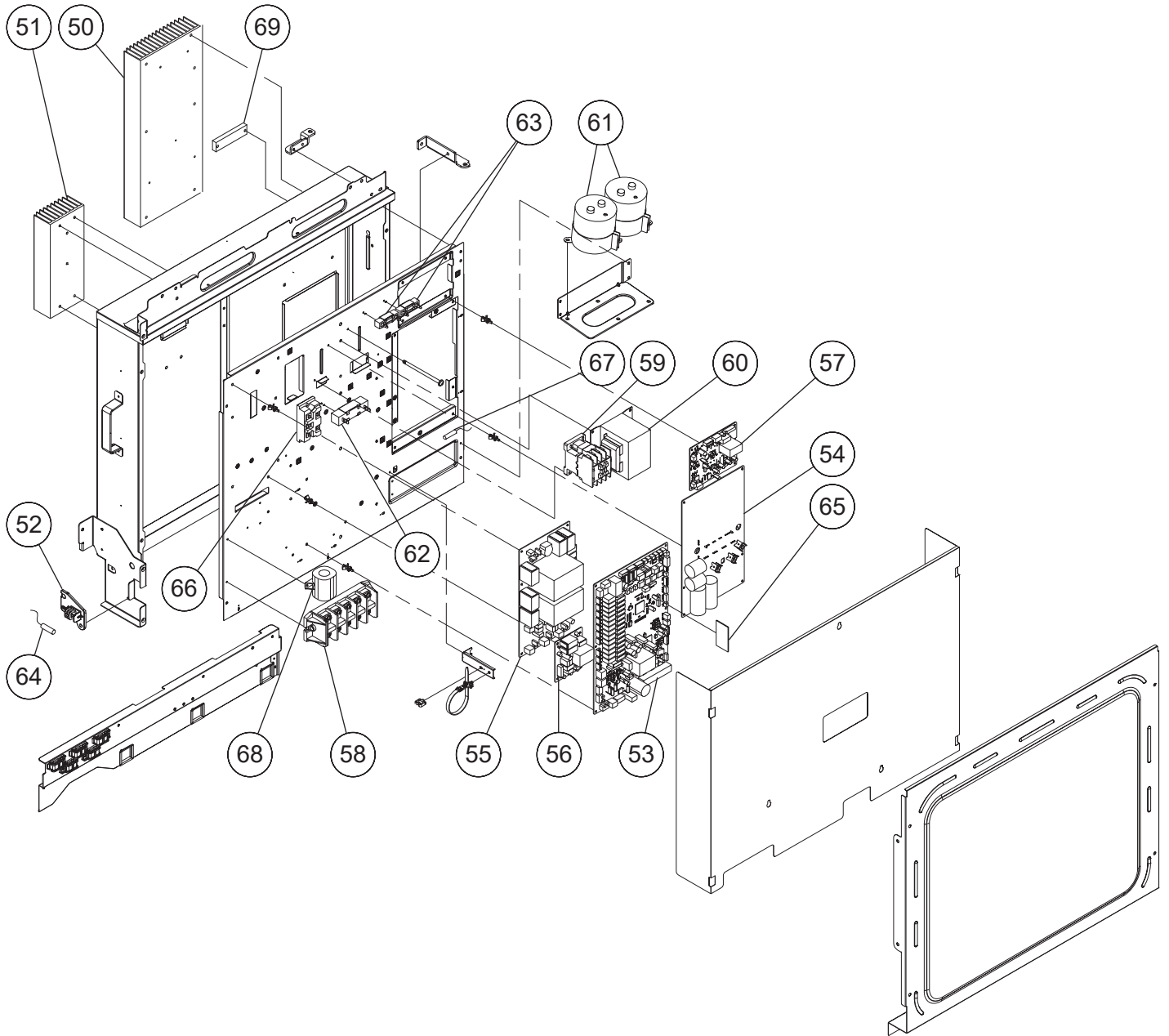

Models : AJ*072GALBH
AJ*090GALBH
AJ*108GALBH

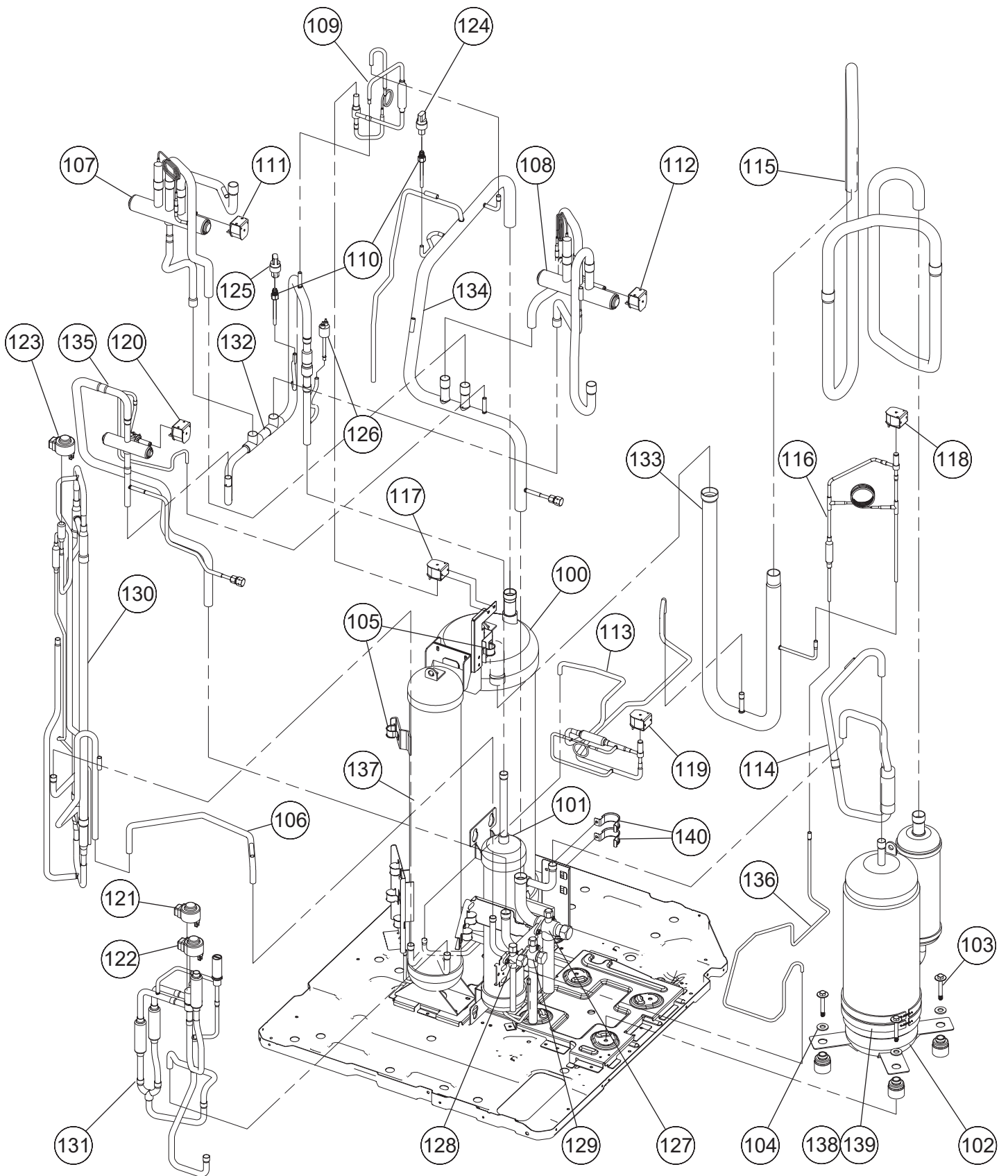

Models : AJ*072GALBH
 AJ*090GALBH
 AJ*108GALBH

Ref No.	Description	Part No.	Ref No.	Description	Part No.
1	FAN GUARD	9378498006	67	HEATSINK THERMISTOR	9900518004
2	BELL MOUTH	9379709002	68	EMI FILTER	0400230113
3	RIGHT PANEL SUB ASSY	9378920002	69	HEAT SINK M	9378511118
4	LEFT PANEL SUB ASSY	9378919006	100	ACCUMULATOR SUB ASSY	9379221023
5	SIDE PILLER SUB ASSY	9379202008	101	OIL SEPARATOR ASSY	9379677011
6	REAR PILLER	9378472006	102	COMPRESSOR(INV) ASSY	9380804017
7	MAIN PILLER	9378468009	103	COMP BOLT	9378474017
8	NET RIGHT SUB ASSY	9378927001	104	WASHER(RUBBER)I	9379179003
9	NET LEFT SUB ASSY	9378928008	105	CLAMP 19	9379459006
10	CONDUIT PLATE	9378493018	106	JNT PIPE(SUB COOL HEX)A	9374381036
11	PROPELLER FAN	9378488007	107	VALVE(4-WAY)A ASSY	9379052030
12	MOTOR,DC BRUSHLESS	9603212018	108	VALVE(4-WAY)B ASSY	9379052047
13	MOTOR BRACKET SUB ASSY	9378925014	109	BYPASS VALVE A ASSY	9378744127
14	LABEL(FUJITSU)	9380477006	110	UNION JOINT	9970091018
14	LABEL(GENERAL)	9378949003	111	SOLENOID 4WV A	9970113031
15	LABEL(AIRSTAGE)	9380479000	112	SOLENOID 4WV B	9970113048
16	TOP PANEL S	9378491014	113	OIL RETURN VALVE A ASSY	9378745032
17	REAR PANEL S SUB ASSY	9378921030	114	DISCHARGE PIPE B ASSY	9378889033
18	NET REAR S SUB ASSY	9378926011	115	SUCTION PIPE B ASSY	9378741072
19	BASE FOOT RS ASSY	9378856035	116	OIL RETURN VALVE B ASSY	9378747128
20	BASE FOOT FS ASSY	9378856011	117	SOLENOID SV1	9970044052
21	FRONT PANEL S	9378480018	118	SOLENOID SV2	9900189198
22	S PANEL TOP S ASSY	9380231011	119	SOLENOID SV3	9900189204
23	S PANEL BTM S ASSY	9380232018	120	SOLENOID SV4	9970126000
24	CONDENSER S SUB ASSY	9379053044	121	COIL(EXPANSION VALVE 1)	9970114014
25	ACCESSORY PIPE A (108)	9379200028	122	COIL(EXPANSION VALVE 2)	9970114021
25	ACCESSORY PIPE A (90/ 72)	9379200011	123	COIL(EXPANSION VALVE 3)	9970101076
26	ACCESSORY PIPE B (108)	9379200004	124	LOW PRESSURE SENSOR	9900505035
26	ACCESSORY PIPE B (90/ 72)	9379200035	125	HIGH PRESSURE SENSOR	9900505028
27	ACCESSORY PIPE C (108/ 90)	9379200066	126	PRESSURE SW (INV COMP)	9900504038
27	ACCESSORY PIPE C (72)	9379200073	127	3WAY VALVE ASSY(Suction gas pipe)	9379039048
28	ACCESSORY PIPE D (108/ 90)	9379200059	128	3WAY VALVE ASSY(Liquid pipe)	9379039031
50	HEAT SINK K	9378511095	129	3WAY VALVE ASSY(Discharge gas pipe)	9379039055
51	HEAT SINK C	9378511026	130	SUB COOL HEX. A ASSY	9378749054
52	THERMO HOLDER	9378510005	131	EXPANSION VALVE ASSY	9378750067
53	MAIN PCB ASSY	9709270172	132	JOINT PIPE OILSEPARATOR A ASSY	9378737099
54	INVERTER PCB ASSY	9709917060	133	SUCTION PIPE D ASSY	9378742079
55	FILTER PCB(INV) ASSY	9709919002	134	JOINT PIPE A ASSY	9378739024
56	FILTER PCB(MAIN) ASSY	9709918012	135	2-WAY VALVE ASSY	9365504079
57	FAN DRIVER PCB ASSY	9709916001	136	JOINT PIPE(OIL SEP)	9379693035
58	TERMINAL	9900251031	137	RECEIVER TANK ASSY	9380825005
59	MAGNETIC RELAY	9900566005	138	CRANK CASE HEATER 1 (L1500)	9901063022
60	REACTOR ASSY	9900748005	139	CRANK CASE HEATER 2 (L2260)	9901063015
61	CAPACITOR	9709615010	140	CLAMP 31 SA	9379432009
62	RESISTOR,CEMENT	0200441016	-	THERMISTOR (TH8,10) ASSY	9900752002
63	RESISTOR,CEMENT	0200444017	-	THERMISTOR (TH3) ASSY	9900753009
64	OUTDOOR TEMP THERMISTOR(TH2)	9900747008	-	THERMISTOR (TH1,11) ASSY	9900884000
65	COMMUNICATION PCB	9707774023	-	THERMISTOR (TH4,5,6) ASSY	9900750008
66	DIODE BRIDGE	0001113093	-	THERMISTOR (TH7,9) ASSY	9900751005

	Description
TH 1	Discharge temp. thermistor 1
TH 3	Suction temp. thermistor
TH 4	Sub-cool heat ex.(inlet liquid) thermistor
TH 5	Sub-cool heat ex.(outlet liquid) thermistor
TH 6	Sub-cool heat ex.(outlet gas) thermistor

	Description
TH 7	Heat ex. 1 (gas) thermistor
TH 8	Heat ex. 2 (gas) thermistor
TH 9	Heat ex. 1 (liquid) thermistor
TH10	Heat ex. 2 (liquid) thermistor
TH11	Compressor shell temp. thermistor