

## 13. Function settings

### 13-1. Setting methods

#### ⚠ WARNING

Never touch electrical components such as the terminal blocks or reactor except the switch on the display board. It may cause a serious accident such as electric shock.

#### ⚠ CAUTION

- Once refrigerant charging is completed, be sure to open the valve prior to performing the local settings. Otherwise, the compressor may fail.
- Discharge any static electricity from your body before touching the push switches. Never touch any terminal or pattern of any parts on the control board.

The positions of the switches on the outdoor unit control board are shown in the figure below.

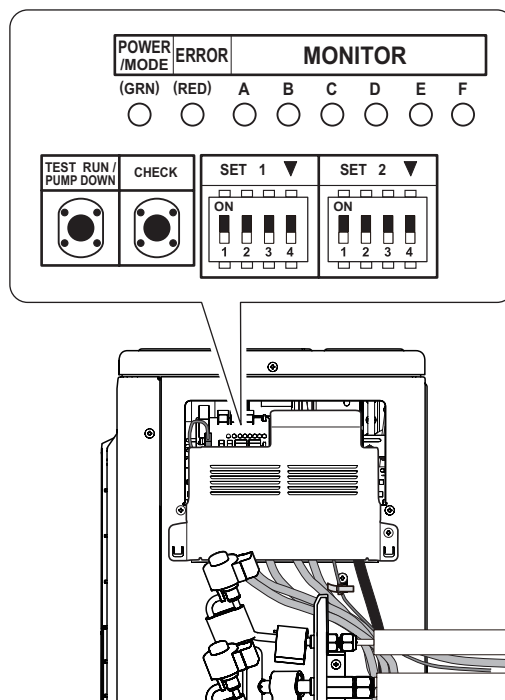

## ■ Setting method

Various settings can be adjusted by changing DIP switches and push switches on the PCB of the outdoor unit.

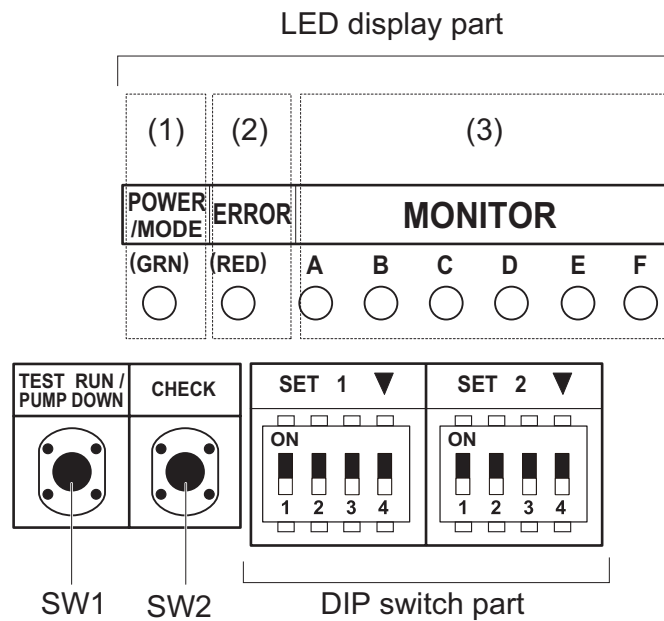

1. Be sure to disconnect the power supply or turn off the breaker.
2. Change the DIP switch setting according to the required setting.

## ■ Description of display

LED lamp			Function or operation method
(1)	POWER/MODE	Green	<ul style="list-style-type: none"> <li>Turns on when the power supply is ON (Including when error occurs).</li> <li>Indicate the MODE by the number of flashes when the installation function is active.</li> </ul>
(2)	ERROR	Red	Flashes at high-speed when there is an error.
(3)	MONITOR	A	<ul style="list-style-type: none"> <li>Displays the location and contents of errors when there is an error. (Refer to Chapter 14-3. "Error code" on page 367 for details.)</li> <li>Displays when check run is activated. (Refer to Chapter 14-1. "Check run" on page 360 for details.)</li> </ul>
		B	
		C	
		D	
		E	
		F	

Switch		Function or operation method	Factory setting
SW1	Push	<ul style="list-style-type: none"> <li>For the test run start and stop.</li> <li>For the pump down start and stop.</li> </ul>	—
SW2	Push	<ul style="list-style-type: none"> <li>For when check run function is activated.</li> <li>For displaying the check run.</li> <li>For resetting the Automatic wiring correction memory.</li> </ul>	—
SET1-1	DIP	For selecting cooling or heating during test operation.	OFF
SET1-2	DIP	For switching SW1 operation.	OFF
SET1-3	DIP	(Prohibited)	OFF (Do not change)
SET1-4	DIP	For outdoor unit low noise operation function.	OFF
SET2-1	DIP	For selecting outdoor unit low noise operation function.	OFF
SET2-2	DIP	(Prohibited)	OFF (Do not change)
SET2-3	DIP	Changing the current limit	OFF
SET2-4	DIP		

Be sure to disconnect the power supply or turn off the breaker before changing the DIP switch setting.

## 13-2. Outdoor unit low noise operation function (option)

Change the outdoor unit low noise operation by using this setting.

### ⚠ CAUTION

- When the low noise operation function is working, cooling and heating capacity will decrease.
- When changing the settings, explain to the customer beforehand that the capacity decreases.

### NOTES:

- When SET1-4 is OFF, optional Central remote controller is required to use this function.
- When SET1-4 is ON, "Operation" and "Non-operation" mode of this function cannot be switched from the Central remote controller.

SET1-4	Setting	Factory setting
ON	Continuous operation	
OFF	Follow the Central remote controller settings	◆

SET2-1	Setting	Factory setting
ON	Lower	
OFF	Low	◆

## 13-3. Changing the current limit function

Change the outdoor unit current limit function by using this setting.

### ⚠ CAUTION

- When the current limited function is working, cooling and heating capacity will decrease.
- When changing the settings, explain to the customer beforehand that the capacity decreases.

SET2-3	SET2-4	Current		Factory setting
		AOYG18KBTA3	AOYG24KBTA3	
OFF	OFF	Full		◆
ON	OFF	10.0 A	12.0 A	
OFF	ON	8.0 A	10.5 A	

## 14. Check and test

### 14-1. Check run

- The check run is a function to screen and detect any wiring errors.
- After carrying out the check run, you can use the automatic wiring correction function to correct the wiring.
- Normal operation is possible without using the check run. In this case, use the test run or forced cooling function of the indoor unit to confirm any wiring errors.

#### ■ Things to confirm before starting the check run

To ensure safety, check that the following work, inspections and operations have been completed.

	Check item	Check column
1	Check that all work on the piping connecting the outdoor unit, indoor units has been completed.	
2	Check that all work on the wiring connecting the outdoor unit, indoor units has been completed.	
3	Is there a gas leakage? (At pipe connections [flange connections and brazed areas])	
4	Is the system charged with the specified volume of refrigerant?	
5	Is a breaker installed at the power supply cable of outdoor unit?	
6	Are the wires connected to the terminals without looseness, and in accordance with the specifications?	
7	Is the 3-way valve of the outdoor unit open? (Gas pipe and liquid pipe)	
8	Is the power supply connected for more than 12 hours?	

#### ■ Restrictions applicable when performing the check run

- When the check run starts, all indoor units connected to the outdoor unit will start to run automatically. During the check run, you cannot check the operation of the indoor units separately. After the check run, check the operation of the indoor units separately in normal operation.
- The check run can be used when the temperature is within the operable temperature of the air conditioner.
- In the check run, the air conditioner will automatically switch between cooling and heating depending on the external temperature and internal temperature.
- The check run can be completed in about 30 minutes (cooling) or about 1 hour (heating), but may take more depending on the external and internal temperature conditions etc.
- Do not conduct the check run with all the windows in the room closed. Otherwise the room temperature could get too low or too high.
- Depending on the difference of the room temperature of each room, a judgment may be impossible.
- Check run is a special operation so there may be a noise louder than the normal refrigerant noise or a creaking noise.



4. After the check run is completed, results will be displayed. Fill the displayed results in the result table accordingly.

- **If the connection is correct (Example: When 4 indoor units are connected)**

After the number of connected units are displayed, the LED for each unit will light up in order from A to D.

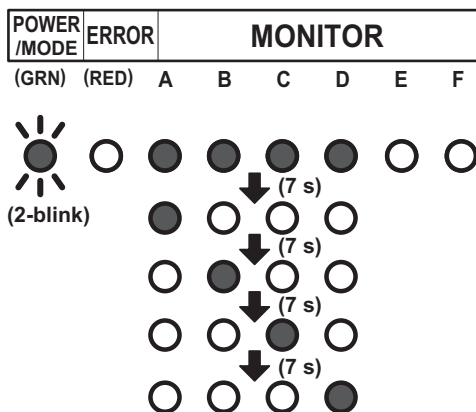

- **If the connection is incorrect (Example: When connection of B and C of the 4 units are reversed)**

After the number of connected units are displayed, B and C will light up in reverse.

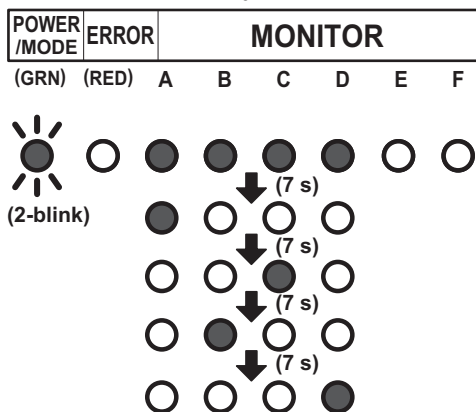

#### NOTES:

- Automatic wiring correction will not be completed if the power supply is disconnected while displaying the results. To confirm the automatic wiring correction, be sure to carry out step 5.
- If frost is formed on the outdoor unit while displaying the results, automatic defrost function will be operated. Proceed to step 5 after the defrost function is finished.

**[How to record the contents]**

- Fill the displayed results according to the following example.

Example: When piping A to D is connected but the wires for B and C are connected in reverse.

<Displayed results>

The LEDs will light up in 7 second intervals in the following order.

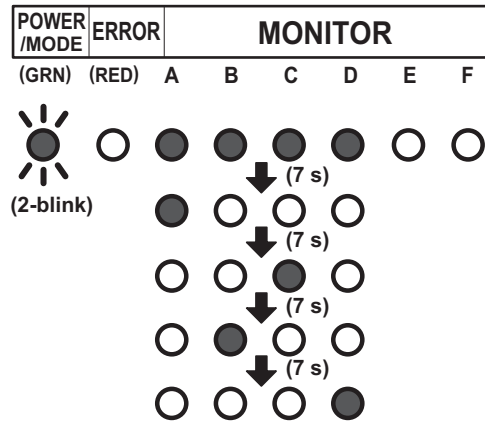

<Example of result table>

- Write a ● where the LEDs light up in the order that they light up.

	A	B	C	D	E	F
1	●	●	●	●	○	○
2	●	○	○	○	○	○
3	○	○	●	○	○	○
4	○	●	○	○	○	○
5	○	○	○	●	○	○
6	○	○	○	○	○	○
7	○	○	○	○	○	○

- Based on the results of step (a), record as follows.

- Trace the dotted circle with a pen if multiple places light up.

A	B	C	D	E	F
○	○	○	○	⋯	⋯

- Write the order from A to D in which the LEDs lit up inside the circle.

A	B	C	D	E	F
Ⓐ	Ⓒ	Ⓑ	Ⓓ	⋯	⋯



c. Select the correction method.

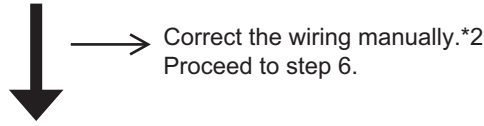

Correct the wiring manually.\*2  
Proceed to step 6.

Use the Automatic wiring correction function.\*1  
Proceed to step 5.

Write down the same results in the label on the reverse side of the service panel.  
The results recorded are needed at the time of servicing.

<Result Table>

	A	B	C	D	E	F
1	○	○	○	○	○	○
2	○	○	○	○	○	○
3	○	○	○	○	○	○
4	○	○	○	○	○	○
5	○	○	○	○	○	○
6	○	○	○	○	○	○
7	○	○	○	○	○	○

A	B	C	D	E	F
○	○	○	○	○	○

**NOTES:**

- \*1: By using this function, the wiring is automatically corrected according to the piping.
- \*2: When correcting the wiring manually, please disconnect the power supply or turn off the breaker during results display, and then change the wiring manually according to the obtained test results.

For example, in Example 1, the wirings connected to the terminals B and C is to be exchanged manually.

5. During results display, press the CHECK switch for 3 seconds or more.  
After LEDs A to F have lit in turn, all LEDs will light up indicating that the automatic wiring correction is completed.

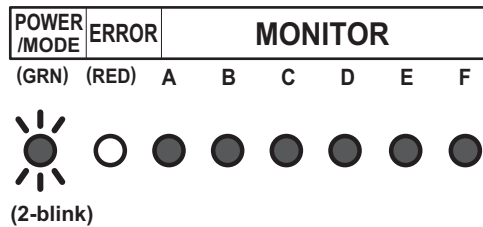

6. Disconnect the power supply or turn off the breaker and wait 10 minutes then turn the power back on and perform test run.

**NOTE:** If you do not disconnect the power supply or turn off the breaker, normal operation is not possible.

**Notices:**

- If an error occurs during check run it will be suspended. Correct the error and start check run again.
- After the check run, if automatic wiring correction is carried out, the indoor unit's position will be modified to match the piping. (Note that the display of the optional remote controller changes.)
- If you start check run again after the automatic wiring correction is finished, the modification will be reset.

OUTDOOR UNIT  
AOYG18-24KBTA3

OUTDOOR UNIT  
AOYG18-24KBTA3

## ■ Failure indication of check-run judgment

The check run stops when there is an error, and the LED shows the relevant error indication. When you encounter the errors described here, perform checking by using the cooling test run of the indoor unit.

### • Temperature out of range judgment

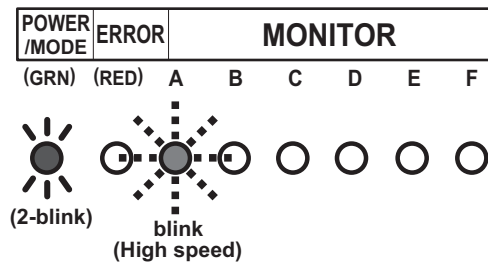

### • Wiring/piping number difference

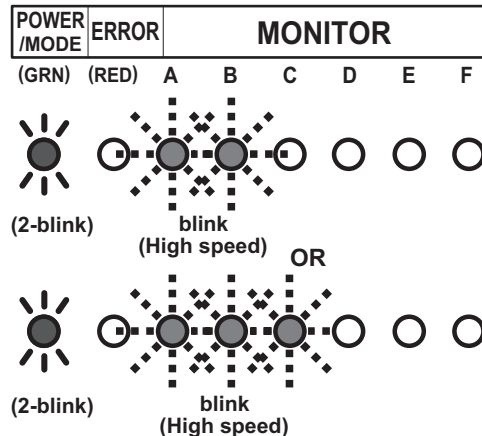

## ■ Redisplaying the results of check run

- When checking the content of automatic wiring correction, push the CHECK switch. The results of the check run is displayed. You can compare the result that is recorded in step (4) of "Chapter 14-1-3. ["Operating procedure for check run"](#) on page 361".
- If the automatic wiring correction is not completed, the POWER/MODE LED blinks twice and the MONITOR LED turns off.

## ■ Memory resetting of automatic wiring correction

### ⚠ CAUTION

When relocating the unit, reset the memory beforehand, or the unit may not function normally.

- Push the CHECK switch.  
The LED lights as shown in ["Redisplaying the results of check run"](#) on page 365".
- When the LED is on, press the CHECK switch for more than 3 seconds.
- The LEDs from A to F light in sequence, and then all LEDs light to indicate the completion of the memory resetting of automatic wiring correction.
- Disconnect the power supply or turn off the breaker.

## 14-2. Test run

### ⚠ CAUTION

Always connect the power supply 12 hours prior to the start of the operation in order to protect the compressor.

1. Indoor unit
    - a. Is the drain normal?
    - b. Is there any abnormal noise and vibration during operation?
  2. Outdoor unit
    - a. Is there any abnormal noise and vibration during operation?
    - b. Will noise, wind, or drain water from the unit disturb the neighbors?
    - c. Is there any gas leakage?
- Do not operate the air conditioner in the test running state for a long time.
  - For the operation method of the test run for indoor unit and central remote controller, refer to the operating manual and perform operation check.

## ■ Test run method

Be sure to temporarily disconnect the power supply or turn off the breaker before changing the DIP switch settings.

1. Check the 3-way valves (both at the liquid side and gas side) are opened. Confirm that the DIP switch SET1-2 is switched off.
2. Set the operation mode to COOL or HEAT. When switching the DIP switch SET1-1 between HEAT and COOL, disconnect the power supply or turn off the circuit breaker beforehand.

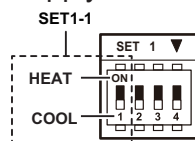

- In the first test run, be sure to set the operation mode to COOL.
- The operation mode cannot be switched between COOL and HEAT during the test run. To switch the operation mode between COOL and HEAT, stop the test run, switch the operation mode, and then start the test run again.
3. Push TEST RUN switch for more than 3 seconds. The POWER / MODE LED flashes once.

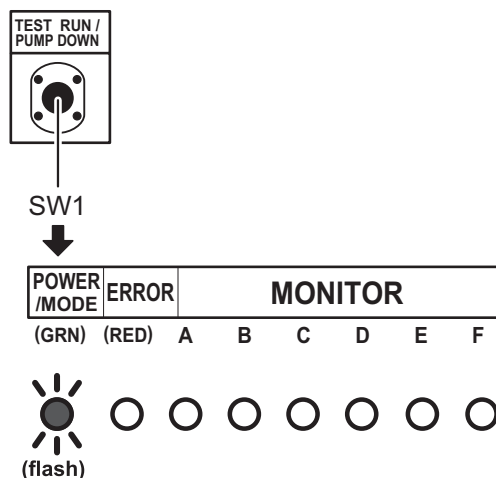

4. Confirm operating status.

- Push TEST RUN switch for more than 3 seconds.

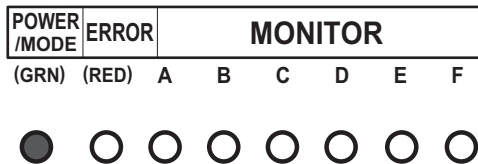

POWER/MODE LED will turn on, and test run stops.

## 14-3. Error code

If an error occurs, the LED lights to inform the relevant location and the code.

When error occurs, the error LED blinks at high speed.

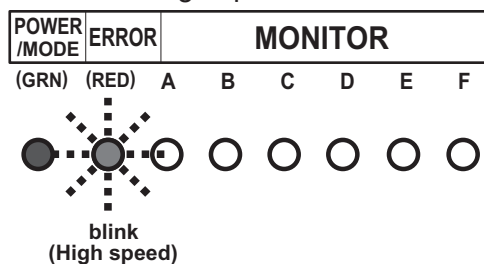

### ■ Error location

LEDs A to F of MONITOR light and indicate the location of the error. In the case of an overall error, LEDs A to F of MONITOR do not light.

**Example:** Coil error on indoor unit B

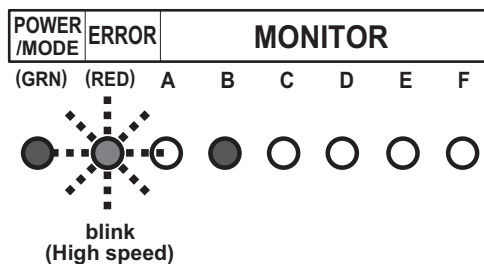

## ■ Error code display

While the error is occurring, briefly push the SW1. The error code is displayed.

**Example: Coil error (Error cord = 9A.1)**

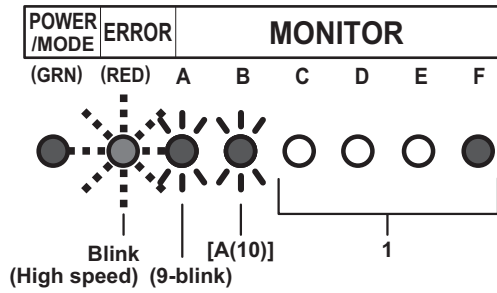

Display mode

LED on: ●

LED off: ○

Blink:   
 (0.5s Light on / 0.5s Light off)

Number of blinking: ( )

For MONITOR (A and B)

- A: 10-blink
- C: 11-blink
- F: 12-blink
- J: 13-blink
- P: 14-blink
- U: 15-blink

C	D	E	F	
○	○	○	●	→ 1
○	○	●	○	→ 2
○	○	●	●	→ 3
○	●	○	○	→ 4
○	●	○	●	→ 5
○	●	●	○	→ 6
○	●	●	●	→ 7
●	○	○	○	→ 8
●	○	○	●	→ 9
●	○	●	○	→ A
●	○	●	●	→ C
●	●	○	○	→ F
●	●	○	●	→ J
●	●	●	○	→ P
●	●	●	●	→ U

OUTDOOR UNIT  
AOYG18-24KBTA3

OUTDOOR UNIT  
AOYG18-24KBTA3

Error code	Error type
11.3	Serial communication error
11.4	Serial communication error during operation
16.5	Communication error between controller and outdoor unit
22.1	Indoor unit capacity error
23.1	Connection prohibited (Series error)
5U.1	Indoor unit error
62.1	PCB model information error
62.3	EEPROM access error
62.8	EEPROM data corruption error
63.1	Inverter error
65.3	IPM error (Trip terminal L error)
71.1	Discharge temp. sensor error
72.1	Compressor temp. sensor error
73.2	Heat exchanger middle temp. sensor error
73.3	Heat exchanger liquid temp. sensor error
74.1	Outdoor temp. sensor error
75.1	Suction gas temp. sensor error
76.1	Valve sensor error
76.2	
77.1	Heat sink temp. sensor error
84.1	Current sensor 1 error (stoppage permanently)
86.1	Discharge pressure sensor error
86.4	High pressure switch 1 error
94.1	Trip detection
95.1	Compressor motor control error (stoppage permanently)
97.3	Fan motor 1 error (Duty error)
98.3	Fan motor 2 error (Duty error)
99.1	4-way valve error
9A.1	Coil 1 (expansion valve 1) error
A1.1	Discharge temperature 1 error (stoppage permanently)
A3.1	Compressor 1 temperature error

## 14-4. Pump down

### ⚠ WARNING

During the pump down operation, make sure that compressor is off before you remove the refrigerant piping. Do not remove the connection pipe while the compressor is in operation with valve open. This may cause abnormal pressure in the refrigeration cycle that leads to breakage and even injury.

### ■ Pump down operation

When moving or discarding the air conditioner, in order to consider the environment and avoid the discharge of refrigerant to the atmosphere, pump down according to the following procedure.

1. Connect the pressure gauge to the charging port.
2. Change the DIP switch on the board (SET1-2) to ON.  
\*Be sure the power supply is disconnected on the breaker is turned off when changing the DIP switch.

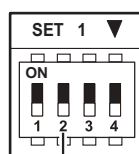

DIP switch  
(SET1-2)

3. To start operation, push the PUMP DOWN switch (SW1) for 3 seconds or push the switch after the power has been on for 3 minutes.



Push switch (SW1)

During pump down, the LED (POWER/MODE) blinks 3 times consecutively.

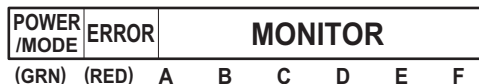

(3-blink)

**NOTE:** If the PUMP DOWN switch (SW1) is pushed while the compressor is in operation, the compressor stops and the operation restart after about 3 minutes.

4. Close the liquid pipe valve.
5. When the value between 7.3 psi and 0 psi (0.05 Mpa to 0 Mpa) is shown, close the gas pipe valve.
6. Stop the pump down operation by pushing the PUMP DOWN switch (SW1) for 3 seconds. The LED light as follows.

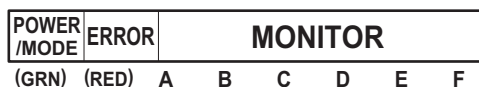

(3-blink)

## 7. Disconnect the power supply or turn off the breaker.

- NOTE:**
- Even if the pump down operation is not stopped by pushing the switch as in step 6, the operation stops automatically after 15 minutes, and the LED light as follows.

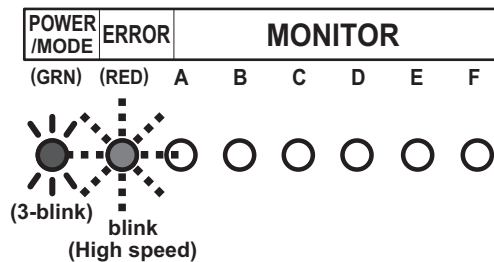

- After completing the pump down operation, disconnect the power supply or turn off the breaker.
  - If the pump down operation still continues, open the liquid pipe valve. Then perform the procedure again starting from step 3.
- To cancel the pump down operation, push the PUMP DOWN switch (SW1) again. The indication of the LED returns to the original state which is before starting the pump down operation.  
(POWER/MODE LED: On)
- The pump down may stop before completion due to an error. To complete the pump down operation, correct the error, open the liquid pipe valve and then start from step 1 again. Otherwise, the refrigerant can be recovered from the service port.