

AIR CONDITIONER

**4-unit multi-split type,
5-unit multi-split type**

DESIGN & TECHNICAL MANUAL

INDOOR



AUXG07KVLA
AUXG09KVLA
AUXG12KVLA
AUXG14KVLA
AUXG18KVLA
AUXG22KVLA



ARXG07KSLAP
ARXG09KSLAP
ARXG12KSLAP
ARXG14KSLAP
ARXG18KSLAP



ARXG07KLLAP
ARXG09KLLAP
ARXG12KLLAP
ARXG14KLLAP
ARXG18KLLAP



ARXG22KMLB



ASYG07KGTB
ASYG09KGTB
ASYG12KGTB
ASYG14KGTB



ASYG18KMTB
ASYG22KMTB
ASYG24KMTB



ASYG07KMTB
ASYG09KMTB
ASYG12KMTB
ASYG14KMTB



ASYG07KETA
ASYG09KETA
ASYG12KETA
ASYG14KETA

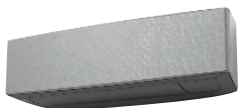

ASYG07KETA-B
ASYG09KETA-B
ASYG12KETA-B
ASYG14KETA-B



ABYG18KRTA
ABYG22KRTA



AGYG09KVCA
AGYG12KVCA
AGYG14KVCA

OUTDOOR



AOYG30KBTA4
AOYG36KBTA5

Notices:

- Product specifications and design are subject to change without notice for future improvement.
- For further details, please check with our authorized dealer.

Trademarks

FGLair™ is trademark of Fujitsu General Limited in the United States, other countries or both.

Google Play™ is trademark of Google Inc.

App Store® is a service mark of Apple Inc., registered in the U.S. and other countries.

CONTENTS

Part 1. INDOOR UNIT.....1

1. Model lineup	2
1-1. Indoor unit connection patterns.....	3
2. Specifications	10
2-1. Compact cassette type	10
2-2. Mini duct type.....	12
2-3. Slim duct type	14
2-4. Medium static pressure duct type	16
2-5. Wall mounted type	17
2-6. Ceiling type	22
2-7. Floor type.....	23
3. Dimensions.....	24
3-1. Compact cassette type	24
3-2. Mini duct type.....	26
3-3. Slim duct type	29
3-4. Medium static pressure duct type	32
3-5. Wall mounted type	34
3-6. Ceiling type	42
3-7. Floor type.....	44
4. Wiring diagrams	46
4-1. Compact cassette type	46
4-2. Mini duct type and Slim duct type	47
4-3. Medium static pressure duct type	48
4-4. Wall mounted type	49
4-5. Ceiling type	54
4-6. Floor type.....	55
5. Air velocity and temperature distributions	56
5-1. Compact cassette type	56
5-2. Mini duct type.....	64
5-3. Slim duct type	74
5-4. Wall mounted type	84
5-5. Ceiling type	87
5-6. Floor type.....	89
6. Fan performance	90
6-1. Mini duct type.....	90
6-2. Slim duct type	100
6-3. Medium static pressure duct type	110
7. Airflow	114
7-1. Compact cassette type	114
7-2. Mini duct type.....	115
7-3. Slim duct type	116

CONTENTS (continued)

7-4. Medium static pressure duct type	117
7-5. Wall mounted type	118
7-6. Ceiling type	122
7-7. Floor type.....	123
8. Noise level curve	124
8-1. Compact cassette type	124
8-2. Mini duct type.....	127
8-3. Slim duct type	130
8-4. Medium static pressure duct type	133
8-5. Wall mounted type	134
8-6. Ceiling type	140
8-7. Floor type.....	141
8-8. Sound level check point	143
9. Electrical characteristics	146
10. Safety devices	148
11. External input and output.....	150
11-1.Compact cassette type, Mini duct type, Slim duct type, and Medium static pressure duct type	150
11-2.Wall mounted type (KGTB, 18-24KMTB, KETA, and KETA-B).....	156
11-3.Wall mounted type (07-14KMTB and KMCC)	166
11-4.Ceiling type	171
11-5.Floor type.....	182
12. Group connection	191
13. Remote controller	193
13-1.Wireless remote controller (AR-REW4E, AR-REM4E, and AR-REB1E).....	193
13-2.Wireless remote controller (AR-REW2E)	197
13-3.Wireless remote controller (AR-REM7E).....	199
13-4.Wireless remote controller (UTY-LNTY: Optional part)	201
13-5.IR receiver kit with Wireless remote controller (UTY-LBTYM: Optional part)	203
13-6.Wired remote controller (UTY-RNNYM: Optional part).....	206
13-7.Wired remote controller (UTY-RLRY: Optional part)	210
13-8.Wired remote controller (UTY-RVNYM: Optional part).....	213
13-9.Wired remote controller (UTY-RNRYZ*: Optional part).....	221
13-10.Simple remote controller (UTY-RSNYM: Optional part)	224
13-11.Simple remote controller (UTY-RSRY and UTY-RHRY: Optional parts)	228
14. Function settings	231
14-1.Compact cassette, Mini duct, Slim duct types indoor unit (setting by DIP switch).....	231
14-2.Indoor unit (setting by wireless remote controller).....	233
14-3.Indoor unit (setting by wired remote controller)	250
14-4.Indoor unit (setting by simple remote controller)	261
14-5.Function details.....	268
14-6.Wired remote controller (UTY-RNNYM).....	276
14-7.Wired remote controller (UTY-RVNYM)	278

CONTENTS (continued)

14-8.Wired remote controller (UTY-RLRY)	279
14-9.Wired remote controller (UTY-RNRYZ*)	279
14-10.Simple remote controller (UTY-RSNYM).....	280
15. Accessories	281
15-1.Compact cassette type	281
15-2.Mini duct type	282
15-3.Slim duct type	284
15-4.Medium static pressure duct type	285
15-5.Wall mounted type	286
15-6.Ceiling type	289
15-7.Floor type	290
16. Optional parts	291
16-1.Controllers	291
16-2.Cassette grille	294
16-3.Others	295
17. Indoor unit installation precautions	299
17-1.Places where prohibited for use	299
17-2.Points to remember when installing	299

CONTENTS (continued)

Part 2. OUTDOOR UNIT (4 UNITS TYPE)303

1. Specifications	304
2. Dimensions	306
2-1. Model: AOYG30KBTA4	306
3. Installation space	307
3-1. Model: AOYG30KBTA4	307
4. Refrigerant circuit	310
4-1. Model: AOYG30KBTA4	310
5. Wiring diagram	311
5-1. Model: AOYG30KBTA4	311
6. Capacity table	312
6-1. Combinations	312
6-2. Cooling capacity	316
6-3. Heating capacity	333
7. Capacity compensation rate for pipe length and height difference	350
7-1. Model: AOYG30KBTA4	350
8. Additional charge calculation	354
8-1. Model: AOYG30KBTA4	354
9. Airflow	355
9-1. Model: AOYG30KBTA4	355
10. Operation noise (sound pressure)	356
10-1.Noise level curve.....	356
10-2.Sound level check point	356
11. Electrical characteristics	357
12. Safety devices	358
13. Function settings	359
13-1.Setting methods	359
13-2.Outdoor unit low noise operation function (option)	362
13-3.Changing the current limit function.....	362
14. Check and test	363
14-1.Check run	363
14-2.Test run.....	369
14-3.Error code	370
14-4.Pump down.....	373
15. Accessories	375
15-1.Model: AOYG30KBTA4	375
16. Outdoor unit installation precautions	376
16-1.Places where prohibited for use.....	376
16-2.Points to remember when installing	376

CONTENTS (continued)

Part 3. OUTDOOR UNIT (5 UNITS TYPE)377

1. Specifications	378
2. Dimensions	380
2-1. Model: AOYG36KBTA5	380
3. Installation space	381
3-1. Model: AOYG36KBTA5	381
4. Refrigerant circuit	384
4-1. Model: AOYG36KBTA5	384
5. Wiring diagram	385
5-1. Model: AOYG36KBTA5	385
6. Capacity table	386
6-1. Combinations	386
6-2. Cooling capacity	392
6-3. Heating capacity	409
7. Capacity compensation rate for pipe length and height difference	426
7-1. Model: AOYG36KBTA5	426
8. Additional charge calculation	430
8-1. Model: AOYG36KBTA5	430
9. Airflow	431
9-1. Model: AOYG36KBTA5	431
10. Operation noise (sound pressure)	432
10-1.Noise level curve.....	432
10-2.Sound level check point	432
11. Electrical characteristics	433
12. Safety devices	434
13. Function settings	435
13-1.Setting methods	435
13-2.Outdoor unit low noise operation function (option)	438
13-3.Changing the current limit function.....	438
14. Check and test	439
14-1.Check run	439
14-2.Test run.....	445
14-3.Error code	446
14-4.Pump down.....	449
15. Accessories	451
15-1.Model: AOYG36KBTA5	451
16. Optional parts	452
17. Outdoor unit installation precautions	453
17-1.Places where prohibited for use.....	453

CONTENTS (continued)

17-2.Points to remember when installing	453
---	-----

Part 1. INDOOR UNIT

COMPACT CASSETTE TYPE:

AUXG07KVLA AUXG14KVLA
AUXG09KVLA AUXG18KVLA
AUXG12KVLA AUXG22KVLA

SLIM DUCT TYPE:

ARXG07KLLAP ARXG14KLLAP
ARXG09KLLAP ARXG18KLLAP
ARXG12KLLAP

MINI DUCT TYPE:

ARXG07KSLAP ARXG14KSLAP
ARXG09KSLAP ARXG18KSLAP
ARXG12KSLAP

MEDIUM STATIC PRES- SURE DUCT TYPE:

ARXG22KMLB

WALL MOUNTED TYPE:

ASYG07KGTB ASYG18KMTB ASYG07KMTB ASYG07KMCC ASYG07KETA(-B)
ASYG09KGTB ASYG22KMTB ASYG09KMTB ASYG09KMCC ASYG09KETA(-B)
ASYG12KGTB ASYG24KMTB ASYG12KMTB ASYG12KMCC ASYG12KETA(-B)
ASYG14KGTB ASYG14KMTB ASYG14KMCC ASYG14KETA(-B)



CEILING TYPE:

ABYG18KRTA ABYG22KRTA

FLOOR TYPE:

AGYG09KVCA AGYG14KVCA
AGYG12KVCA

1. Model lineup

Indoor unit			
 <p>AUXG07KVLA AUXG09KVLA AUXG12KVLA AUXG14KVLA AUXG18KVLA AUXG22KVLA</p>	 <p>ARXG07KSLAP ARXG09KSLAP ARXG12KSLAP ARXG14KSLAP ARXG18KSLAP</p>	 <p>ARXG07KLLAP ARXG09KLLAP ARXG12KLLAP ARXG14KLLAP ARXG18KLLAP</p>	 <p>ARXG22KMLB</p>
 <p>ASYG07KGTB ASYG09KGTB ASYG12KGTB ASYG14KGTB</p>	 <p>ASYG18KMTB ASYG22KMTB ASYG24KMTB</p>	 <p>ASYG07KMTB ASYG09KMTB ASYG12KMTB ASYG14KMTB ASYG07KMCC ASYG09KMCC ASYG12KMCC ASYG14KMCC</p>	 <p>ASYG07KETA ASYG09KETA ASYG12KETA ASYG14KETA</p>
 <p>ASYG07KETA-B ASYG09KETA-B ASYG12KETA-B ASYG14KETA-B</p>	 <p>ABYG18KRTA ABYG22KRTA</p>	 <p>AGYG09KVCA AGYG12KVCA AGYG14KVCA</p>	
Outdoor unit			
 <p>AOYG30KBTA4 AOYG36KBTA5</p>			

1-1. Indoor unit connection patterns

■ 4-unit multi-split type

AOYG30KBTA4					
Combination no.	Unit 1	Unit 2	Unit 3	Unit 4	Total
1	7	22	—	—	29
2	7	24	—	—	31
3	9	22	—	—	31
4	9	24	—	—	33
5	12	18	—	—	30
6	12	22	—	—	34
7	12	24	—	—	36
8	14	18	—	—	32
9	14	22	—	—	36
10	14	24	—	—	38
11	18	18	—	—	36
12	18	22	—	—	40
13	18	24	—	—	42
14	22	22	—	—	44
15	22	24	—	—	46
16	24	24	—	—	48
17	7	7	12	—	26
18	7	7	14	—	28
19	7	7	18	—	32
20	7	7	22	—	36
21	7	7	24	—	38
22	7	9	9	—	25
23	7	9	12	—	28
24	7	9	14	—	30
25	7	9	18	—	34
26	7	9	22	—	38
27	7	9	24	—	40
28	7	12	12	—	31
29	7	12	14	—	33
30	7	12	18	—	37
31	7	12	22	—	41
32	7	12	24	—	43
33	7	14	14	—	35
34	7	14	18	—	39
35	7	14	22	—	43
36	7	14	24	—	45
37	7	18	18	—	43
38	7	18	22	—	47
39	7	18	24	—	49
40	9	9	9	—	27
41	9	9	12	—	30
42	9	9	14	—	32
43	9	9	18	—	36
44	9	9	22	—	40
45	9	9	24	—	42
46	9	12	12	—	33
47	9	12	14	—	35
48	9	12	18	—	39
49	9	12	22	—	43
50	9	12	24	—	45

AOYG30KBTA4					
Combination no.	Unit 1	Unit 2	Unit 3	Unit 4	Total
51	9	14	14	—	37
52	9	14	18	—	41
53	9	14	22	—	45
54	9	14	24	—	47
55	12	12	12	—	36
56	12	12	14	—	38
57	12	12	18	—	42
58	12	12	22	—	46
59	12	12	24	—	48
60	12	14	14	—	40
61	12	14	18	—	44
62	12	18	18	—	48
63	14	14	14	—	42
64	14	14	18	—	46
65	7	7	7	7	28
66	7	7	7	9	30
67	7	7	7	12	33
68	7	7	7	14	35
69	7	7	7	18	39
70	7	7	9	9	32
71	7	7	9	12	35
72	7	7	9	14	37
73	7	7	9	18	41
74	7	7	12	12	38
75	7	7	12	14	40
76	7	7	12	18	44
77	7	7	14	14	42
78	7	7	14	18	46
79	7	9	9	9	34
80	7	9	9	12	37
81	7	9	9	14	39
82	7	9	9	18	43
83	7	9	12	12	40
84	7	9	12	14	42
85	7	9	12	18	46
86	7	9	14	14	44
87	7	9	14	18	48
88	7	12	12	12	43
89	7	12	12	14	45
90	7	12	12	18	49
91	7	12	14	14	47
92	9	9	9	9	36
93	9	9	9	12	39
94	9	9	9	14	41
95	9	9	9	18	45
96	9	9	12	12	42
97	9	9	12	14	44
98	9	9	12	18	48
99	9	9	14	14	46
100	9	12	12	12	45
101	9	12	12	14	47
102	9	12	14	14	49
103	12	12	12	12	48

Numbers in column Unit 1 to 4, and Total indicate the indoor unit capacities as follows:

7: 7,000 Btu/h, 9: 9,000 Btu/h, 12: 12,000 Btu/h, 14: 14,000 Btu/h

■ 5-unit multi-split type

AOYG36KBTA5						
Combination no.	Unit 1	Unit 2	Unit 3	Unit 4	Unit 5	Total
1	7	24	—	—	—	31
2	9	22	—	—	—	31
3	9	24	—	—	—	33
4	12	22	—	—	—	34
5	12	24	—	—	—	36
6	14	22	—	—	—	36
7	14	24	—	—	—	38
8	18	18	—	—	—	36
9	18	22	—	—	—	40
10	18	24	—	—	—	42
11	22	22	—	—	—	44
12	22	24	—	—	—	46
13	24	24	—	—	—	48
14	7	7	14	—	—	28
15	7	7	18	—	—	32
16	7	7	22	—	—	36
17	7	7	24	—	—	38
18	7	9	12	—	—	28
19	7	9	14	—	—	30
20	7	9	18	—	—	34
21	7	9	22	—	—	38
22	7	9	24	—	—	40
23	7	12	12	—	—	31
24	7	12	14	—	—	33
25	7	12	18	—	—	37
26	7	12	22	—	—	41
27	7	12	24	—	—	43
28	7	14	14	—	—	35
29	7	14	18	—	—	39
30	7	14	22	—	—	43
31	7	14	24	—	—	45
32	7	18	18	—	—	43
33	7	18	22	—	—	47
34	7	18	24	—	—	49
35	9	9	9	—	—	27
36	9	9	12	—	—	30
37	9	9	14	—	—	32
38	9	9	18	—	—	36
39	9	9	22	—	—	40
40	9	9	24	—	—	42
41	9	12	12	—	—	33
42	9	12	14	—	—	35
43	9	12	18	—	—	39
44	9	12	22	—	—	43
45	9	12	24	—	—	45
46	9	14	14	—	—	37
47	9	14	18	—	—	41
48	9	14	22	—	—	45
49	9	14	24	—	—	47
50	9	18	18	—	—	45
51	9	18	22	—	—	49
52	9	18	24	—	—	51

AOYG36KBTA5						
Combination no.	Unit 1	Unit 2	Unit 3	Unit 4	Unit 5	Total
53	12	12	12	—	—	36
54	12	12	14	—	—	38
55	12	12	18	—	—	42
56	12	12	22	—	—	46
57	12	12	24	—	—	48
58	12	14	14	—	—	40
59	12	14	18	—	—	44
60	12	14	22	—	—	48
61	12	14	24	—	—	50
62	12	18	18	—	—	48
63	12	18	22	—	—	52
64	12	18	24	—	—	54
65	14	14	14	—	—	42
66	14	14	18	—	—	46
67	14	14	22	—	—	50
68	14	14	24	—	—	52
69	14	18	18	—	—	50
70	18	18	18	—	—	54
71	7	7	7	7	—	28
72	7	7	7	9	—	30
73	7	7	7	12	—	33
74	7	7	7	14	—	35
75	7	7	7	18	—	39
76	7	7	7	22	—	43
77	7	7	7	24	—	45
78	7	7	9	9	—	32
79	7	7	9	12	—	35
80	7	7	9	14	—	37
81	7	7	9	18	—	41
82	7	7	9	22	—	45
83	7	7	9	24	—	47
84	7	7	12	12	—	38
85	7	7	12	14	—	40
86	7	7	12	18	—	44
87	7	7	12	22	—	48
88	7	7	12	24	—	50
89	7	7	14	14	—	42
90	7	7	14	18	—	46
91	7	7	14	22	—	50
92	7	7	14	24	—	52
93	7	7	18	18	—	50
94	7	9	9	9	—	34
95	7	9	9	12	—	37
96	7	9	9	14	—	39
97	7	9	9	18	—	43
98	7	9	9	22	—	47
99	7	9	9	24	—	49
100	7	9	12	12	—	40
101	7	9	12	14	—	42
102	7	9	12	18	—	46
103	7	9	12	22	—	50
104	7	9	12	24	—	52
105	7	9	14	14	—	44
106	7	9	14	18	—	48
107	7	9	14	22	—	52

AOYG36KBTA5						
Combination no.	Unit 1	Unit 2	Unit 3	Unit 4	Unit 5	Total
108	7	9	14	24	—	54
109	7	9	18	18	—	52
110	7	12	12	12	—	43
111	7	12	12	14	—	45
112	7	12	12	18	—	49
113	7	12	14	14	—	47
114	7	12	14	18	—	51
115	7	14	14	14	—	49
116	7	14	14	18	—	53
117	9	9	9	9	—	36
118	9	9	9	12	—	39
119	9	9	9	14	—	41
120	9	9	9	18	—	45
121	9	9	9	22	—	49
122	9	9	9	24	—	51
123	9	9	12	12	—	42
124	9	9	12	14	—	44
125	9	9	12	18	—	48
126	9	9	12	22	—	52
127	9	9	12	24	—	54
128	9	9	14	14	—	46
129	9	9	14	18	—	50
130	9	9	18	18	—	54
131	9	12	12	12	—	45
132	9	12	12	14	—	47
133	9	12	12	18	—	51
134	9	12	14	14	—	49
135	9	12	14	18	—	53
136	9	14	14	14	—	51
137	12	12	12	12	—	48
138	12	12	12	14	—	50
139	12	12	12	18	—	54
140	12	12	14	14	—	52
141	12	14	14	14	—	54
142	7	7	7	7	7	35
143	7	7	7	7	9	37
144	7	7	7	7	12	40
145	7	7	7	7	14	42
146	7	7	7	7	18	46
147	7	7	7	7	22*	50
148	7	7	7	7	24	52
149	7	7	7	9	9	39
150	7	7	7	9	12	42
151	7	7	7	9	14	44
152	7	7	7	9	18	48
153	7	7	7	9	22*	52
154	7	7	7	9	24	54
155	7	7	7	12	12	45
156	7	7	7	12	14	47
157	7	7	7	12	18	51
158	7	7	7	14	14	49
159	7	7	7	14	18	53
160	7	7	9	9	9	41
161	7	7	9	9	12	44
162	7	7	9	9	14	46

AOYG36KBTA5						
Combination no.	Unit 1	Unit 2	Unit 3	Unit 4	Unit 5	Total
163	7	7	9	9	18	50
164	7	7	9	9	22*	54
165	7	7	9	12	12	47
166	7	7	9	12	14	49
167	7	7	9	12	18	53
168	7	7	9	14	14	51
169	7	7	12	12	12	50
170	7	7	12	12	14	52
171	7	7	12	14	14	54
172	7	9	9	9	9	43
173	7	9	9	9	12	46
174	7	9	9	9	14	48
175	7	9	9	9	18	52
176	7	9	9	12	12	49
177	7	9	9	12	14	51
178	7	9	9	14	14	53
179	7	9	12	12	12	52
180	7	9	12	12	14	54
181	9	9	9	9	9	45
182	9	9	9	9	12	48
183	9	9	9	9	14	50
184	9	9	9	9	18	54
185	9	9	9	12	12	51
186	9	9	9	12	14	53
187	9	9	12	12	12	54

Numbers in column Unit 1 to 5 and Total indicate the indoor unit capacities as follows:
7: 7,000 Btu/h, 9: 9,000 Btu/h, 12: 12,000 Btu/h, 14: 14,000 Btu/h

*: As for the 22 model, wall-mounted type indoor unit is only connectable.

2. Specifications

2-1. Compact cassette type

Model name				AUXG07KVLA	AUXG09KVLA	AUXG12KVLA	AUXG14KVLA	
Power supply				1Ø 230 V ~50 Hz				
Available voltage range				198—264 V				
Capacity		kW class		2.0	2.5	3.5	4.0	
Input power		W		18		23	28	
Running current		A		0.15		0.19	0.22	
Fan	Airflow rate	Cooling	HIGH	m ³ /h	540		610	680
			MED		490		530	580
			LOW		440		470	490
			QUIET		390		410	410
		Heating	HIGH		540		610	790
			MED		490		530	680
			LOW		440		470	580
			QUIET		390		410	450
	Type × Q'ty		Turbo fan × 1					
	Motor output		W		54			
Sound pressure level *	Cooling	HIGH	dB (A)	33		37	38	
		MED		31		34	35	
		LOW		29		31	32	
		QUIET		27		28	29	
	Heating	HIGH		34		37	43	
		MED		32		34	38	
		LOW		29		31	34	
		QUIET		27		29	30	
Sound power level	Cooling	dB (A)		46		49	50	
	Heating			47		49	55	
Heat exchanger type	Dimensions (H × W × D)		mm	Main1: 210 × 1,310 × 13.3 Main2: 210 × 1,250 × 13.3				
	Fin pitch		mm	1.2				
	Rows × Stages			Main1: 1 × 10 Main2: 1 × 10				
	Pipe type			Copper tube				
	Fin type			Aluminum				
Dimensions (H × W × D)	Net		mm	245 × 570 × 570				
	Gross			265 × 730 × 625				
Weight	Net		kg	15				
	Gross			19				
Connection pipe	Size	Liquid	mm (in)	Ø6.35 (Ø1/4)				
		Gas		Ø9.52 (Ø3/8)				
	Method			Flare				
Drain hose	Material		PVC					
	Tip diameter		mm	Ø25 (I.D.), Ø32 (O.D.)				
Operation range	Cooling		°C	18 to 32				
			%RH	80 or less				
	Heating		°C	16 to 30				
Cassette grille (Grid type: Option)	Model name			UTG-UFYF-W				
	Material			Polystyrene				
	Color			White Approximate color of Munsell 9PB 9.1/0.2				
	Dimensions (H × W × D)	Net		mm	49 × 620 × 620			
		Gross			120 × 765 × 755			
	Weight	Net		kg	2.3			
Gross		4.5						
NOTES:								
<ul style="list-style-type: none"> • The protective function might work when using it outside the operation range. • *: Sound pressure level: <ul style="list-style-type: none"> – These are the measured values in the manufacturer's anechoic chamber. – Because of the surrounding sound environment, the sound levels measured in actual installation conditions might be higher than the specified values here. 								

Model name				AUXG18KVLA		AUXG22KVLA		
Power supply				1Ø 230 V ~50 Hz				
Available voltage range				198—264 V				
Capacity			kW class		5.0		6.0	
Input power			W		39		84	
Running current			A		0.30		0.62	
Fan	Airflow rate	Cooling	HIGH	m ³ /h	680		830	
			MED		580		740	
			LOW		490		600	
			QUIET		410		450	
		Heating	HIGH		790		860	
			MED		680		760	
			LOW		580		700	
			QUIET		450		530	
	Type × Q'ty		Turbo fan × 1					
	Motor output		W		54			
Sound pressure level *	Cooling	dB (A)	HIGH	38		44		
			MED	35		42		
			LOW	32		36		
			QUIET	29		30		
	Heating	dB (A)	HIGH	43		45		
			MED	38		43		
			LOW	34		40		
			QUIET	30		33		
Sound power level	Cooling	dB (A)	50		56			
	Heating		55		57			
Heat exchanger type	Dimensions (H × W × D)		mm	Main1: 210 × 1,310 × 13.3 Main2: 210 × 1,250 × 13.3		Main1: 210 × 1,360 × 13.3 Main2: 210 × 1,295 × 13.3 Main3: 210 × 1,235 × 13.3		
	Fin pitch			1.2		1.45		
	Rows × Stages		Main1: 1 × 10 Main2: 1 × 10		Main1: 1 × 10 Main2: 1 × 10 Main3: 1 × 10			
	Pipe type		Copper tube					
	Fin type		Aluminum					
Dimensions (H × W × D)	Net		mm	245 × 570 × 570				
	Gross			265 × 730 × 625				
Weight	Net		kg	15		16		
	Gross			19		20		
Connection pipe	Size	Liquid	mm (in)	Ø6.35 (Ø1/4)				
		Gas		Ø12.70 (Ø1/2)				
Method		Flare						
Material		PVC						
Drain hose	Tip diameter		mm	Ø25 (I.D.), Ø32 (O.D.)				
	°C			18 to 32				
Operation range	Cooling		%RH	80 or less				
	Heating			16 to 30				
Cassette grille (Grid type: Option)	Model name		UTG-UFYF-W					
	Material		Polystyrene					
	Color		White Approximate color of Munsell 9PB 9.1/0.2					
	Dimensions (H × W × D)	Net		mm	49 × 620 × 620			
		Gross			120 × 765 × 755			
	Weight	Net		kg	2.3			
Gross		4.5						

NOTES:

- The protective function might work when using it outside the operation range.
- *: Sound pressure level:
 - These are the measured values in the manufacturer's anechoic chamber.
 - Because of the surrounding sound environment, the sound levels measured in actual installation conditions might be higher than the specified values here.

2-2. Mini duct type

Model name				ARXG07KSLAP	ARXG09KSLAP	ARXG12KSLAP	ARXG14KSLAP	
Power supply				1Ø 230 V ~50 Hz				
Available voltage range				198—264 V				
Capacity			kW class	2.0	2.5	3.5	4.0	
Input power	Fan	HIGH	W	33	40	47	72	
		MED		23	23	26	44	
		LOW		20	20	22	30	
		QUIET		18	18	18	18	
Running current			A	0.29	0.33	0.38	0.58	
Fan	Airflow rate	Cooling	HIGH	m ³ /h	550	600	650	800
			MED		440	450	490	640
			LOW		390	400	430	530
			QUIET		360	360	360	360
		Heating	HIGH		550	600	650	800
			MED		440	450	490	640
			LOW		390	400	430	530
			QUIET		360	360	360	360
	Type × Q'ty			Sirocco fan × 2				
	Motor output			W	75			
Recommended static pressure			Pa	0 to 30			0 to 50	
Sound pressure level *	Cooling	HIGH	dB (A)	29	29	31	35	
		MED		26	26	27	30	
		LOW		24	24	25	27	
		QUIET		23	23	23	23	
	Heating	HIGH		29	29	31	35	
		MED		26	26	27	30	
		LOW		24	24	25	27	
		QUIET		23	23	23	23	
Sound power level	Cooling	dB (A)	52	54	55	60		
	Heating		53	56	57	62		
Heat exchanger type	Dimensions (H × W × D)		mm	336 × 490 × 26.6				
	Fin pitch		mm	1.3				
	Rows × Stages			2 × 16				
	Pipe type			Copper tube				
	Fin type			Aluminum				
Enclosure	Material			Steel sheet				
	Color			—				
Dimensions (H × W × D)	Net		mm	198 × 700 × 450				
	Gross			250 × 930 × 580				
Weight	Net		kg	15.5				
	Gross			19.0				
Connection pipe	Size	Liquid	mm (in)	Ø6.35 (Ø1/4)				
		Gas		Ø9.52 (Ø3/8)				
	Method				Flare			
Drain hose	Material			Hard PVC				
	Tip diameter		mm	Ø25 (I.D.), Ø32 (O.D.)				
Operation range	Cooling	°C	18 to 32					
		%RH	80 or less					
	Heating	°C	16 to 30					

NOTES:

- Values mentioned in the table are based on the following conditions:
 - Static pressure: 10 Pa
- The protective function might work when using it outside the operation range.
- *: Sound pressure level:
 - These are the measured values in the manufacturer's anechoic chamber.
 - Because of the surrounding sound environment, the sound levels measured in actual installation conditions might be higher than the specified values here.

Model name				ARXG18KSLAP		
Power supply				1Ø 230 V ~ 50 Hz		
Available voltage range				198—264 V		
Capacity			kW class	5.0		
Input power	Fan	HIGH	W	63		
		MED		38		
		LOW		22		
		QUIET		19		
Running current			A	0.49		
Fan	Airflow rate	Cooling	HIGH	m ³ /h	940	
			MED		750	
			LOW		540	
			QUIET		480	
		Heating	HIGH		940	
			MED		750	
			LOW		540	
			QUIET		480	
	Type × Q'ty			Sirocco fan × 3		
	Motor output			W	80	
Recommended static pressure			Pa	0 to 50		
Sound pressure level *	Cooling	HIGH	dB (A)	33		
		MED		29		
		LOW		26		
		QUIET		23		
	Heating	HIGH		33		
		MED		29		
		LOW		26		
		QUIET		23		
Sound power level	Cooling	dB (A)		58		
	Heating			59		
Heat exchanger type	Dimensions (H × W × D)		mm	336 × 690 × 26.6		
	Fin pitch			1.30		
	Rows × Stages		2 × 16			
	Pipe type		Copper tube			
	Fin type		Aluminum			
Enclosure	Material		Steel sheet			
	Color		—			
Dimensions (H × W × D)	Net		mm	198 × 900 × 450		
	Gross			250 × 1,130 × 580		
Weight	Net		kg	18.5		
	Gross			23.0		
Connection pipe	Size	Liquid	mm (in)	Ø6.35 (Ø1/4)		
		Gas		Ø12.7 (Ø1/2)		
	Method		Flare			
Drain hose	Material		PVC			
	Tip diameter		mm	Ø25 (I.D.), Ø32 (O.D.)		
Operation range	Cooling	°C		18 to 32		
		%RH		80 or less		
	Heating	°C		16 to 30		

NOTES:

- Values mentioned in the table are based on the following conditions:
 - Static pressure: 15 Pa
- The protective function might work when using it outside the operation range.
- *: Sound pressure level:
 - These are the measured values in the manufacturer's anechoic chamber.
 - Because of the surrounding sound environment, the sound levels measured in actual installation conditions might be higher than the specified values here.

2-3. Slim duct type

Model name				ARXG07KLLAP	ARXG09KLLAP	ARXG12KLLAP	ARXG14KLLAP	
Power supply				1Ø 230 V ~50 Hz				
Available voltage range				198—264 V				
Capacity		kW class		2.0	2.5	3.5	4.0	
Input power		W		33	49	58	76	
Running current		A		0.33	0.30	0.35	0.51	
Fan	Airflow rate	Cooling	HIGH	m ³ /h	550	600	650	800
			MED		490	550	600	700
			LOW		470	500	550	600
			QUIET		440	450	480	480
	Heating	HIGH	550	600	650	800		
		MED	490	550	600	700		
		LOW	470	500	550	600		
		QUIET	440	450	480	480		
	Type × Q'ty		Sirocco fan × 2					
	Motor output		W		80	81		
Recommended static pressure				Pa				
				0 to 90				
Sound pressure level *	Cooling	HIGH	dB (A)	28	28	29	32	
		MED		26	27	28	30	
		LOW		25	26	27	28	
		QUIET		24	25	26	26	
	Heating	HIGH		28	28	29	32	
		MED		26	26	28	30	
		LOW		25	25	27	28	
		QUIET		24	24	24	25	
Sound power level	Cooling		dB (A)		57			
	Heating				57			
Heat exchanger type	Dimensions (H × W × D)		mm	294 × 500 × 26.6	294 × 500 × 39.9			
	Fin pitch		mm	1.3				
	Rows × Stages		2 × 14		3 × 14			
	Pipe type		Copper tube					
	Fin type		Aluminum					
Enclosure	Material		Steel sheet					
	Color		—					
Dimensions (H × W × D)	Net		mm	198 × 700 × 620				
	Gross			276 × 968 × 772				
Weight	Net		kg	16		17		
	Gross			21		22		
Connection pipe	Size	Liquid	mm (in)	Ø6.35 (Ø1/4)				
		Gas		Ø9.52 (Ø3/8)				
	Method			Flare				
Drain hose	Material		PVC					
	Tip diameter		mm	Ø25 (I.D.), Ø32 (O.D.)				
Operation range	Cooling	°C		18 to 32				
		%RH		80 or less				
	Heating		°C		16 to 30			

NOTES:

- Values mentioned in the table are based on the following conditions:
 - Static pressure: 25 Pa
- The protective function might work when using it outside the operation range.
- *: Sound pressure level:
 - These are the measured values in the manufacturer's anechoic chamber.
 - Because of the surrounding sound environment, the sound levels measured in actual installation conditions might be higher than the specified values here.

Model name				ARXG18KLLAP		
Power supply				1Ø 230 V ~50 Hz		
Available voltage range				198—264 V		
Capacity			kW class	5.0		
Input power				W		
Running current				A		
Fan	Airflow rate	Cooling	HIGH	m ³ /h	940	
			MED		880	
			LOW		820	
			QUIET		750	
		Heating	HIGH		940	
			MED		880	
			LOW		820	
			QUIET		750	
	Type × Q'ty			Sirocco fan × 3		
	Motor output			W	81	
Recommended static pressure				Pa	0 to 90	
Sound pressure level *	Cooling	HIGH	dB (A)	32		
		MED		30		
		LOW		29		
		QUIET		27		
	Heating	HIGH		32		
		MED		30		
		LOW		29		
		QUIET		27		
Sound power level		Cooling	dB (A)	58		
		Heating		58		
Heat exchanger type	Dimensions (H × W × D)		mm	294 × 700 × 39.9		
	Fin pitch		mm	1.3		
	Rows × Stages		3 × 14			
	Pipe type		Copper tube			
	Fin type		Aluminum			
Enclosure	Material			Steel sheet		
	Color			—		
Dimensions (H × W × D)	Net		mm	198 × 900 × 620		
	Gross			276 × 1,168 × 772		
Weight	Net		kg	20		
	Gross			26		
Connection pipe	Size	Liquid	mm (in)	Ø6.35 (Ø1/4)		
		Gas		Ø12.70 (Ø1/2)		
	Method		Flare			
Drain hose	Material			PVC		
	Tip diameter		mm	Ø25 (I.D.), Ø32 (O.D.)		
Operation range	Cooling			°C	18 to 32	
				%RH	80 or less	
	Heating			°C	16 to 30	
NOTES:						
<ul style="list-style-type: none"> • Values mentioned in the table are based on the following conditions: <ul style="list-style-type: none"> – Static pressure: 25 Pa • The protective function might work when using it outside the operation range. • *: Sound pressure level: <ul style="list-style-type: none"> – These are the measured values in the manufacturer's anechoic chamber. – Because of the surrounding sound environment, the sound levels measured in actual installation conditions might be higher than the specified values here. 						

2-4. Medium static pressure duct type

Model name				ARXG22KMLB		
Power supply				1Ø 230 V ~50 Hz		
Available voltage range				198—264 V		
Capacity			kW class			
Input power				W		
Running current				A		
Fan	Airflow rate	Cooling	HIGH	m ³ /h	1,100	
			MED		910	
			LOW		750	
			QUIET		580	
		Heating	HIGH		1,100	
			MED		910	
			LOW		750	
			QUIET		580	
	Type × Q'ty			Sirocco fan × 2		
	Motor output			W		
Recommended static pressure				Pa		
Sound pressure level *				dB (A)		
Sound pressure level *		Cooling	HIGH	31		
			MED	29		
			LOW	27		
			QUIET	25		
		Heating	HIGH	31		
			MED	29		
			LOW	27		
			QUIET	25		
Sound power level		Cooling	dB (A)			
		Heating	62			
Heat exchanger type		Dimensions (H × W × D)		mm		
		Fin pitch		mm		
		Rows × Stages		3 × 14		
		Pipe type		Copper tube		
		Fin type		Aluminum		
Enclosure	Material			Steel sheet		
	Color			—		
Dimensions (H × W × D)	Net		mm			
	Gross		300 × 1,320 × 790			
Weight	Net		kg			
	Gross		43			
Connection pipe	Size	Liquid	mm (in)			
		Gas	Ø6.35 (Ø1/4)			
	Method		Ø12.70 (Ø1/2)			
Operation range	Cooling			°C		
				%RH		
	Heating			°C		
Drain hose	Material			Steel		
	Size			mm		

NOTES:

- Specifications are based on the following conditions:
 - Cooling: Indoor temperature of 27 °CDB/19 °CWB, and outdoor temperature of 35 °CDB/24 °CWB.
 - Heating: Indoor temperature of 20 °CDB/15 °CWB, and outdoor temperature of 7 °CDB/6 °CWB.
 - Standard static pressure: 35 Pa.
 - Pipe length: 5 m, Height difference: 0 m. (Between outdoor unit and indoor unit.)
- Protective function might work when using it outside the operation range.
- *1: Maximum operating current is the total current of the indoor unit and the outdoor unit.
- *2: Sound pressure level:
 - Measured values in manufacturer's anechoic chamber.
 - Because of the surrounding sound environment, the sound levels measured in actual installation conditions might be higher than the specified values here.
- *3: Available on Google Play™ store or on App Store®. Optional WLAN adapter is also required. For details, refer to the setting manual.

2-5. Wall mounted type

Model name				ASYG07KGTB	ASYG09KGTB	ASYG12KGTB	ASYG14KGTB	
Power supply				1Ø 230 V ~50 Hz				
Available voltage range				198—264 V				
Capacity			kW class	2.0	2.5	3.5	4.0	
Input power			W	23	27	27	33	
Running current			A	0.20	0.24	0.24	0.29	
Fan	Airflow rate	Cooling	HIGH	m ³ /h	650	700	700	770
			MED		540	560	560	600
			LOW		430	430	430	450
			QUIET		270	270	270	280
		Heating	HIGH		720	750	770	800
			MED		580	610	640	660
			LOW		460	470	520	520
			QUIET		330	330	330	340
	Type × Q'ty			Crossflow fan × 1				
	Motor output			W	30		49	
Sound pressure level *1	Cooling	HIGH	dB (A)	38	40	40	43	
		MED		33	34	35	36	
		LOW		29	29	30	30	
		QUIET		21	21	21	21	
	Heating	HIGH		41	42	42	44	
		MED		35	36	38	39	
		LOW		31	31	33	33	
		QUIET		22	22	22	24	
Sound power level	Cooling	dB (A)	54	55	56	57		
	Heating		56	57	58	59		
Heat exchanger type	Dimensions (H × W × D)		mm	Main1: 210 × 670 × 26.6 Main2: 112 × 670 × 20.0		Main1: 210 × 670 × 26.6, Main2: 112 × 670 × 20.0 Sub: 84 × 670 × 13.3		
	Fin pitch		mm	Main1: 1.2, Main2: 1.1		Main1: 1.2, Main2: 1.1, Sub: 1.4		
	Rows × Stages			Main1: 2 × 10, Main2: 2 × 7		Main1: 2 × 10, Main2: 2 × 7, Sub: 1 × 4		
	Pipe type			Copper tube				
Fin type			Aluminum					
Enclosure	Material			Polystyrene				
	Color			White + Pearl white (painted) Approximate color of Munsell N 9.25/				
Dimensions (H × W × D)	Net		mm	270 × 834 × 215				
	Gross			277 × 914 × 332				
Weight	Net		kg	10.0				
	Gross			12.5		13.0		
Connection pipe	Size	Liquid	mm (in)	Ø6.35 (Ø1/4)				
		Gas		Ø9.52 (Ø3/8)				
	Method			Flare				
Drain hose	Material		PP + HDPE					
	Tip diameter		mm	Ø13.8 (I.D.), Ø15.0 to Ø16.8 (O.D.)				
Operation range	Cooling	°C		18 to 32				
		%RH		80 or less				
Remote controller type	Heating	°C		16 to 30				
		Wireless (Option: Wired, Mobile app*2 [FGLair™])						

NOTES:

- The protective function might work when using it outside the operation range.
- *1: Sound pressure level:
 - These are the measured values in the manufacturer's anechoic chamber.
 - Because of the surrounding sound environment, the sound levels measured in actual installation conditions might be higher than the specified values here.
- *2: Available on Google Play™ store or on App Store®. Optional WLAN adapter is also required. For details, refer to the setting manual.

Model name				ASYG18KMTB	ASYG22KMTB	ASYG24KMTB	
Power supply				1Ø 230 V ~50 Hz			
Available voltage range				198—264 V			
Capacity			kW class	5.0	6.0	7.0	
Input power				W	37.5	47.0	
Running current				A	0.35	0.39	
Fan	Airflow rate	Cooling	HIGH	m ³ /h	980	1,060	1,170
			MED		810	810	850
			LOW		640	640	640
			QUIET		510	510	510
		Heating	HIGH		1,020	1,060	1,170
			MED		850	850	850
			LOW		640	640	640
			QUIET		510	510	510
	Type × Q'ty				Cross flow fan × 1		
	Motor output				W	59	59
Sound pressure level *1	Cooling	HIGH	dB (A)	45	48	49	
		MED		40	40	40	
		LOW		35	35	35	
		QUIET		29	29	29	
	Heating	HIGH		46	48	49	
		MED		40	40	40	
		LOW		35	35	35	
		QUIET		29	29	29	
Sound power level	Cooling	dB (A)	60	62	65		
	Heating		61	62	65		
Heat exchanger type	Dimensions (H × W × D)		mm	Main1: 210 × 798 × 26.6 Main2: 135 × 798 × 20.0 Sub1: 84 × 798 × 13.3 Sub2: 84 × 798 × 13.3			
	Fin pitch		mm	Main1: 1.2, Main2: 1.1 Sub1: 1.4, Sub2: 1.4			
	Rows × Stages			Main1: 2 × 10 Main2: 2 × 8 Sub1: 1 × 4 Sub2: 1 × 4			
	Pipe type			Copper tube			
	Fin type			Aluminum			
Enclosure	Material			Polystyrene			
	Color			White + Pearl white (painted) Approximate color of Munsell N 9.25/			
Dimensions (H × W × D)	Net		mm	280 × 980 × 240			
	Gross			322 × 1,078 × 346			
Weight	Net		kg	12.5			
	Gross			18			
Connection pipe	Size	Liquid	mm (in)	Ø6.35 (Ø1/4)			
		Gas		Ø12.70 (Ø1/2)			
	Method			Flare			
Drain hose	Material			PP + HDPE			
	Tip diameter		mm	Ø13.8 (I.D.), Ø 15.8 to Ø 16.7 (O.D)			
Operation range	Cooling		°C	18 to 32			
	Heating		%RH	80 or less			
			°C	16 to 30			
Remote controller type				Wireless remote controller (Option: Wired remote controller, Mobile app*2 [FGLair™])			
NOTES:							
<ul style="list-style-type: none"> The protective function might work when using it outside the operation range. *1: Sound pressure level: <ul style="list-style-type: none"> These are the measured values in the manufacturer's anechoic chamber. Because of the surrounding sound environment, the sound levels measured in actual installation conditions might be higher than the specified values here. *2: Available on Google Play™ store or on App Store®. Optional WLAN adapter is also required. For details, refer to the setting manual. 							

Model name				ASYG07KMTB	ASYG09KMTB	ASYG12KMTB	ASYG14KMTB	
Power supply				1Ø 230 V ~50 Hz				
Available voltage range				198—264 V				
Capacity			kW class	2.0	2.5	3.5	4.0	
Input power			W	23	27	27	33	
Running current			A	0.20	0.24	0.24	0.30	
Fan	Airflow rate	Cooling	HIGH	m ³ /h	650	700	700	770
			MED		540	560	560	600
			LOW		430	430	430	450
			QUIET		270	270	270	280
		Heating	HIGH		720	750	770	800
			MED		580	610	640	660
			LOW		460	470	520	520
			QUIET		330	330	330	340
	Type × Q'ty			Crossflow fan × 1				
	Motor output			W	30			49
Sound pressure level *1	Cooling	HIGH	dB (A)	38	40	40	43	
		MED		33	34	35	36	
		LOW		29	29	30	30	
		QUIET		21	21	21	21	
	Heating	HIGH		41	42	42	44	
		MED		35	36	38	39	
		LOW		31	31	33	33	
		QUIET		22	22	22	24	
Sound power level	Cooling	dB (A)	54	55	55	57		
	Heating		56	57	58	59		
Heat exchanger type	Dimensions (H × W × D)		mm	Main1: 210 × 670 × 26.6 Main2: 112 × 670 × 20.0			Main1: 210 × 670 × 26.6 Main2: 112 × 670 × 20.0 Sub: 84 × 670 × 13.3	
	Fin pitch		mm	Main1: 1.2, Main2: 1.1			Main1: 1.2, Main2: 1.1 Sub: 1.4	
	Rows × Stages			Main1: 2 × 10, Main2: 2 × 7			Main1: 2 × 10 Main2: 2 × 7 Sub: 1 × 4	
	Pipe type			Copper tube				
	Fin type			Aluminum				
Enclosure	Material		Polystyrene					
	Color		White + Pearl white (painted) Approximate color of Munsell N 9.25/					
Dimensions (H × W × D)	Net	mm	270 × 834 × 222					
	Gross		277 × 914 × 332					
Weight	Net	kg	10.0					
	Gross		12.5			13.0		
Connection pipe	Size	Liquid	mm (in)	Ø6.35 (Ø1/4)				
		Gas		Ø9.52 (Ø3/8)				
	Method			Flare				
Drain hose	Material		PP + HDPE					
	Size		mm	Ø13.8 (I.D.), Ø15.0 to Ø16.8 (O.D.)				
Operation range	Cooling	°C	18 to 32					
		%RH	80 or less					
Remote controller type	Heating	°C	16 to 30					
		Wireless (Option: Wired, Mobile app*2 [FGLair™])						
NOTES:								
<ul style="list-style-type: none"> The protective function might work when using it outside the operation range. *1: Sound pressure level: <ul style="list-style-type: none"> These are the measured values in the manufacturer's anechoic chamber. Because of the surrounding sound environment, the sound levels measured in actual installation conditions might be higher than the specified values here. *2: Available on Google Play™ store or on App Store®. Optional WLAN adapter is also required. For details, refer to the setting manual. 								

Model name				ASYG07KMCC	ASYG09KMCC	ASYG12KMCC	ASYG14KMCC	
Power supply				1Ø 230 V ~50 Hz				
Available voltage range				198—264 V				
Capacity			kW class	2.0	2.5	3.5	4.0	
Input power			W	23	27	27	33	
Running current			A	0.20	0.24	0.24	0.30	
Fan	Airflow rate	Cooling	HIGH	m ³ /h	650	700	700	770
			MED		540	560	560	600
			LOW		430	430	430	450
			QUIET		320	320	320	310
		Heating	HIGH		720	750	780	820
			MED		580	610	640	660
			LOW		460	470	520	520
			QUIET		330	330	330	340
	Type × Q'ty			Crossflow fan × 1				
	Motor output			W	27			
Sound pressure level *1	Cooling	HIGH	dB (A)	38	40	40	43	
		MED		33	34	35	36	
		LOW		29	29	30	30	
		QUIET		21	21	21	21	
	Heating	HIGH		41	42	42	44	
		MED		35	36	38	39	
		LOW		31	31	33	33	
		QUIET		22	22	22	24	
Heat exchanger type	Dimensions (H × W × D)		mm	Main1: 210 × 670 × 26.6 Main2: 112 × 670 × 20			Main1: 210 × 670 × 26.6 Main2: 112 × 670 × 20 Sub: 84 × 670 × 13.3	
	Fin pitch			Man1: 1.2, Main2: 1.1			Man1: 1.2, Main2: 1.1, Sub: 1.4	
	Rows × Stages		Main1: 2 × 10, Main2: 2 × 7			Main1: 2 × 10, Main2: 2 × 7, Sub: 1 × 4		
	Pipe type		Copper tube					
	Fin type		Aluminum					
Enclosure	Material		Polystyrene					
	Color		White + Pearl white (painted) Approximate color of Munsell N 9.25/					
Dimensions (H × W × D)	Net		mm	270 × 834 × 222				
	Gross			277 × 914 × 332				
Weight	Net		kg	10.0				
	Gross			12.5		13.0		
Connection pipe	Size	Liquid	mm (in)	Ø6.35 (Ø1/4)				
		Gas		Ø9.52 (Ø3/8)				
	Method			Flare				
Drain hose	Material		PP + HDPE					
	Tip diameter		mm	Ø13.8 (I.D.), Ø15.0 to Ø16.8 (O.D.)				
Operation range	Cooling		°C	18 to 32				
	Heating		%RH	80 or less				
			°C	16 to 30				
Remote controller type				Wireless (Wired, Mobile app*2 [FGLair™] [option])				
NOTES:								
<ul style="list-style-type: none"> The protective function might work when using it outside the operation range. *1: Sound pressure level: <ul style="list-style-type: none"> These are the measured values in the manufacturer's anechoic chamber. Because of the surrounding sound environment, the sound levels measured in actual installation conditions might be higher than the specified values here. *2: Available on Google Play™ store or on App Store®. Optional WLAN adapter is also required. For details, refer to the setting manual. 								

Model name			ASYG07KETA ASYG07KETA-B	ASYG09KETA ASYG09KETA-B	ASYG12KETA ASYG12KETA-B	ASYG14KETA ASYG14KETA-B	
Power supply			1Ø 230 V ~50 Hz				
Available voltage range			198—264 V				
Capacity		kW class	2.0	2.5	3.5	4.0	
Input power		W	23	27	27	33	
Running current		A	0.20	0.24	0.24	0.30	
Fan	Airflow rate	Cooling	HIGH	650	700	700	770
			MED	540	560	560	600
			LOW	430	430	430	450
			QUIET	270	270	270	280
		Heating	HIGH	720	750	770	800
			MED	580	610	640	660
			LOW	460	470	520	520
			QUIET	330	330	330	340
	Type × Q'ty		Crossflow fan × 1				
	Motor output		W	30			49
Sound pressure level *1	Cooling	HIGH	38	40	40	43	
		MED	33	34	35	36	
		LOW	29	29	30	30	
		QUIET	21	21	21	21	
	Heating	HIGH	41	42	42	44	
		MED	35	36	38	39	
		LOW	31	31	33	33	
		QUIET	22	22	22	24	
Sound power level		dB (A)	54	55	55	57	
			56	57	58	59	
Heat exchanger type	Dimensions (H × W × D)		mm	Main1: 210 × 670 × 26.6 Main2: 112 × 670 × 20.0		Main1: 210 × 670 × 26.6 Main2: 112 × 670 × 20.0 Sub: 84 × 670 × 13.3	
	Fin pitch		mm	Main1: 1.2, Main2: 1.1		Main1: 1.2, Main2: 1.1 Sub: 1.4	
	Rows × Stages			Main1: 2 × 10, Main2: 2 × 7		Main1: 2 × 10 Main2: 2 × 7 Sub: 1 × 4	
	Pipe type			Copper tube			
	Fin type			Aluminum			
Enclosure	Material		Polystyrene				
	Color		KETA; White + Pearl white (painted) Approximate color of Munsell N 9.25/ KETA-B; Dark Gray + Silver (painted) Approximate color of Munsell 0.5P 3.5/0.2				
Dimensions (H × W × D)	Net	mm	295 × 950 × 230				
	Gross		284 × 1,027 × 357				
Weight	Net	kg	11.0		11.5		
	Gross		14.5		15.0		
Connection pipe	Size	mm (in)	Ø6.35 (Ø1/4)				
	Method		Ø9.52 (Ø3/8)				
Drain hose	Material		Flare				
	Tip diameter		PP + HDPE				
Operation range			Ø13.8 (I.D.), Ø15.0 to Ø16.8 (O.D.)				
	Cooling	°C	18 to 32				
		%RH	80 or less				
Heating	°C	16 to 30					
Remote controller type			Wireless (Option: Wired, Mobile app*2 [FGLair™])				
NOTES:							
<ul style="list-style-type: none"> The protective function might work when using it outside the operation range. *1: Sound pressure level: <ul style="list-style-type: none"> These are the measured values in the manufacturer's anechoic chamber. Because of the surrounding sound environment, the sound levels measured in actual installation conditions might be higher than the specified values here. *2: Available on Google Play™ store or on App Store®. Optional WLAN adapter is also required. For details, refer to the setting manual. 							

2-6. Ceiling type

Model name				ABYG18KRTA	ABYG22KRTA	
Power supply				1Ø 230 V ~50 Hz		
Available voltage range				198—264 V		
Capacity		kW class		5.0	6.0	
Input power		W		37	46	
Running current		A		0.21	0.25	
Fan	Airflow rate	Cooling	HIGH	m ³ /h	840	900
			MED		790	790
			LOW		710	710
			QUIET		650	650
		Heating	HIGH		840	900
			MED		790	790
			LOW		710	710
			QUIET		650	650
	Type × Q'ty		Sirocco × 2			
	Motor output		W		50	50
Sound pressure level *	Cooling	dB (A)	HIGH	38	42	
			MED	36	37	
			LOW	33	34	
			QUIET	31	31	
	Heating	dB (A)	HIGH	38	42	
			MED	36	37	
			LOW	33	34	
			QUIET	31	31	
Sound power level		dB (A)		53	57	
Heat exchanger type	Dimensions (H × W × D)		mm	294 × 715 × 39.9		
	Fin pitch		mm	1.30		
	Rows × Stages			3 × 14		
	Pipe type			Copper		
	Fin type			Aluminum		
Enclosure	Material			Steel sheet		
	Color			White Approximate color of Munsell N9.25/		
Dimensions (H × W × D)	Net		mm	235 × 1,080 × 705		
	Gross			330 × 1,165 × 825		
Weight	Net		kg	24	24	
	Gross			33	33	
Connection pipe	Size	Liquid	mm (in)	Ø6.35 (Ø1/4)		
		Gas		Ø12.70 (Ø1/2)		
Method		Flare				
Drain hose	Material			PVC		
	Tip diameter		mm	Ø25 (I.D.), Ø32 (O.D.)		
Operation range	Cooling	°C		18 to 32		
		%RH		80 or less		
	Heating	°C		16 to 30		
Remote controller type				Wired remote controller, Wireless remote controller, Mobile app*3 (FGLair™)		
NOTES:						
<ul style="list-style-type: none"> • Specifications are based on the following conditions: <ul style="list-style-type: none"> – Cooling: Indoor temperature of 27 °CDB/19 °CWB, and outdoor temperature of 35 °CDB/24 °CWB. – Heating: Indoor temperature of 20 °CDB/15 °CWB, and outdoor temperature of 7 °CDB/6 °CWB. – Pipe length: 5 m, Height difference: 0 m. (Between outdoor unit and indoor unit.) • Protective function might work when using it outside the operation range. • *: Sound pressure level: <ul style="list-style-type: none"> – Measured values in manufacturer's anechoic chamber. – Because of the surrounding sound environment, the sound levels measured in actual installation conditions might be higher than the specified values here. 						

2-7. Floor type

Model name				AGYG09KVCA	AGYG12KVCA	AGYG14KVCA	
Power supply				230 V ~ 50 Hz			
Available voltage range				198—264 V			
Capacity		kW class		2.5	3.5	4.0	
Input power		W		16	20	23	
Running current		A		0.15	0.18	0.20	
Fan	Airflow rate	Cooling	HIGH	530	600	650	
			MED	440	490	520	
			LOW	360	380	400	
			QUIET	270	270	270	
		Heating	HIGH	530	600	650	
			MED	460	510	540	
			LOW	380	410	430	
			QUIET	270	270	270	
		Type × Q'ty		Cross flow fan × 2			
		Motor output		W		16 × 2	
Sound pressure level *	Cooling	HIGH	39	42	44		
		MED	34	36	38		
		LOW	28	30	31		
		QUIET	22	22	22		
	Heating	HIGH	39	42	44		
		MED	35	38	39		
		LOW	30	32	33		
		QUIET	22	22	22		
Sound power level	Cooling	dB (A)		52	55	56	
	Heating	dB (A)		52	55	56	
Heat exchanger type	Dimensions (H × W × D)		mm	378 × 550 × 26.6			
	Fin pitch			1.2			
	Rows × Stages		2 × 18				
	Pipe type		Copper tube				
	Fin type		Aluminum				
Enclosure	Material		Polystyrene				
	Color		White				
Dimensions (H × W × D)	Net		mm	600 × 740 × 200			
	Gross			700 × 820 × 310			
Weight	Net		kg	14			
	Gross			18			
Connection pipe	Size	Liquid	mm (in)	Ø6.35 (Ø1/4)			
		Gas		Ø9.52 (Ø3/8)			
	Method		Flare				
Drain hose	Material		PP + LLDPE				
	Tip diameter		mm			Ø13.8 (I.D.), Ø15.8 to Ø16.7 (O.D.)	
Operation range	Cooling		°C	18 to 32			
	Heating		%RH	80 or less			
Remote controller type				°C			30 or less
Remote controller type				Wireless (Wired, Simple mobile app [option])			

NOTES:

- Specifications are based on the following conditions:
 - Cooling: Indoor temperature of 27 °CDB/19 °CWB, and outdoor temperature of 35 °CDB/24 °CWB.
 - Heating: Indoor temperature of 20 °CDB/15 °CWB, and outdoor temperature of 7 °CDB/6 °CWB.
 - Pipe length: 5 m, Height difference: 0 m. (Between outdoor unit and indoor unit.)
- Protective function might work when using it outside the operation range.
- *: Sound pressure level:
 - Measured values in manufacturer's anechoic chamber.
 - Because of the surrounding sound environment, the sound levels measured in actual installation conditions might be higher than the specified values here.

3. Dimensions

3-1. Compact cassette type

■ Models: AUXG07KVLA, AUXG09KVLA, AUXG12KVLA, AUXG14KVLA, AUXG18KVLA, and AUXG22KVLA

Unit: mm

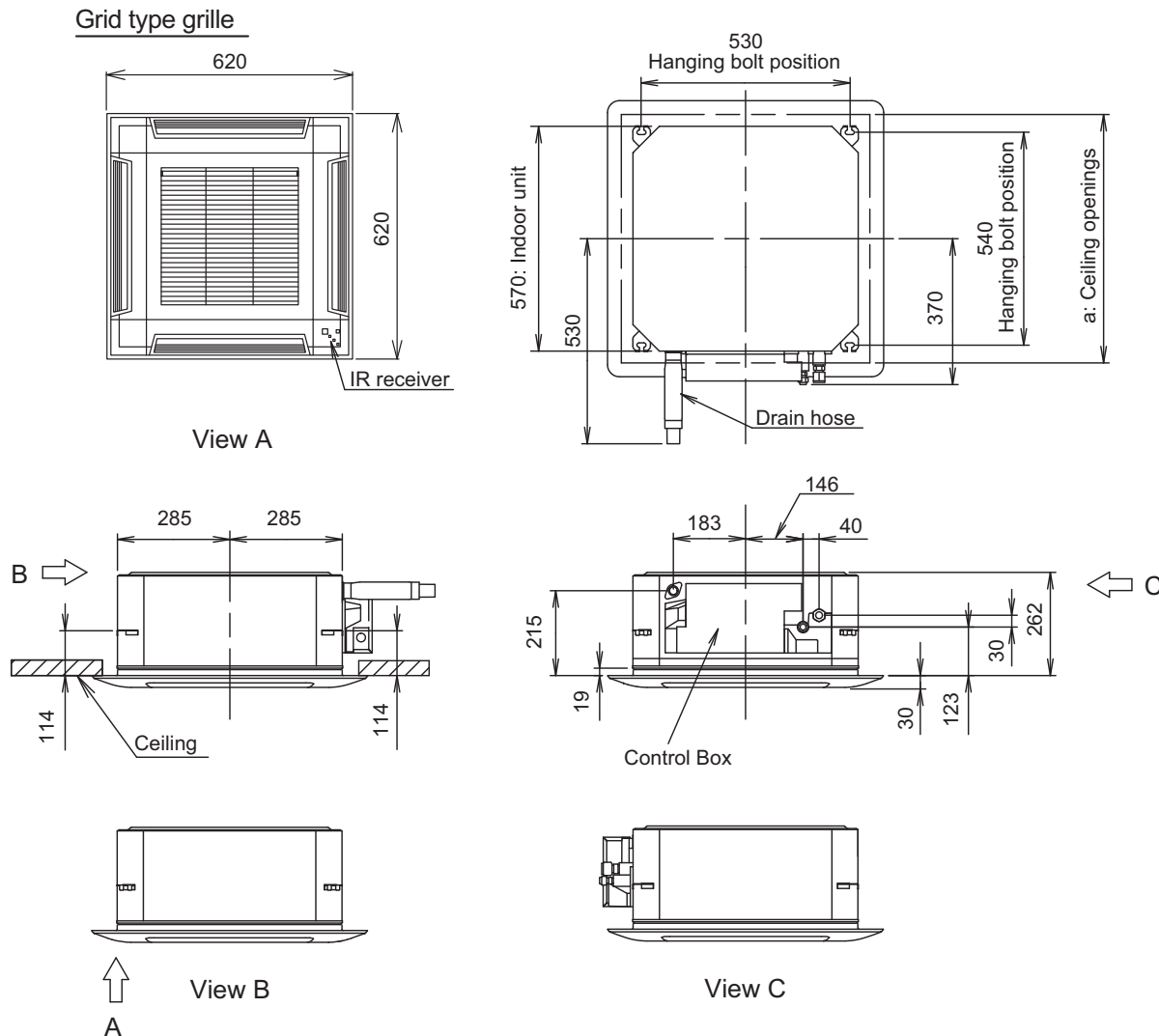

a: Ceiling openings		
Cassette grille (Option [Grid type])	mm	580 to 610

● Installation space requirement

Unit: mm

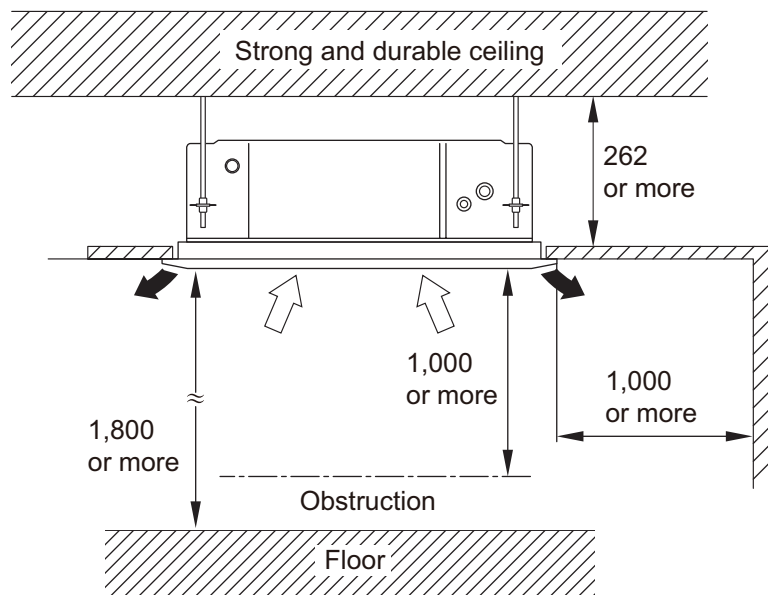

Maximum height from floor to ceiling (Unit: mm)		
	07 and 09 models	12 or larger models
Standard	2,700	
High ceiling	—	3,000

3-way direction setting:

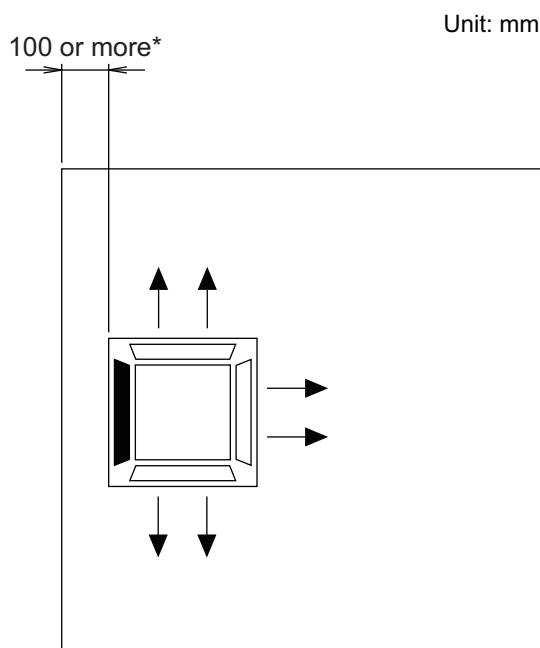

NOTES:

- To set "3-direction", optional Air outlet shutter plate (UTR-YDZB) must be installed, and the "outlet-direction" need to be switched to "3-way" by remote controller.
*When installing the indoor unit, be careful about the maintenance space.
- In 3-way outlet mode, changing of ceiling height setting by function setting 20 is prohibited. (Ceiling height setting [function setting 20] is allowed to be changed only in 4-way outlet mode.)

3-2. Mini duct type

■ Models: ARXG07KSLAP, ARXG09KSLAP, ARXG12KSLAP, and ARXG14KSLAP

Unit: mm

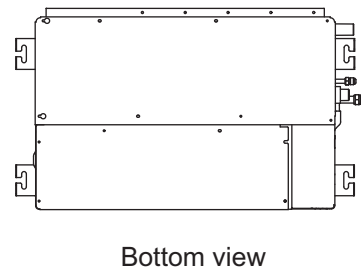
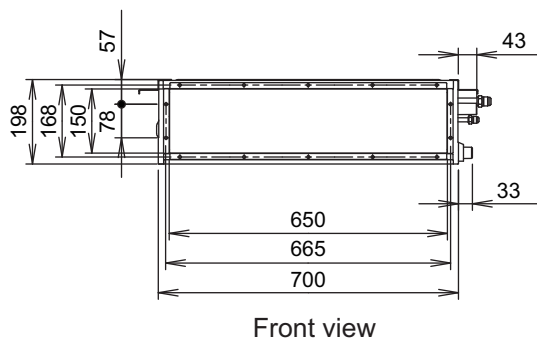
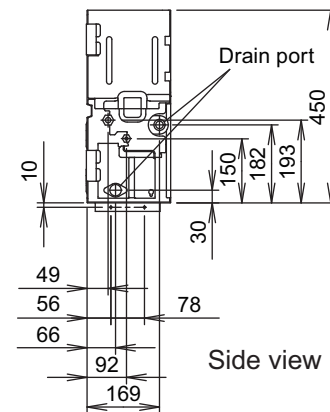
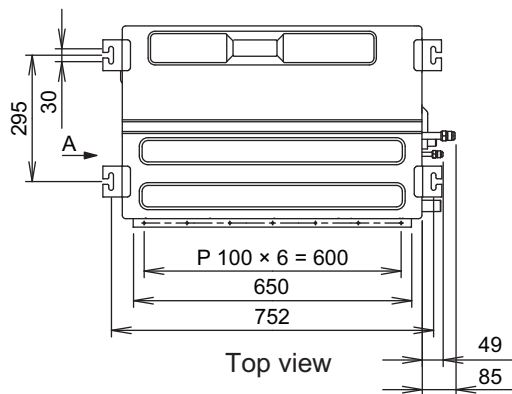
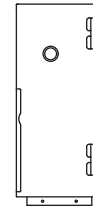
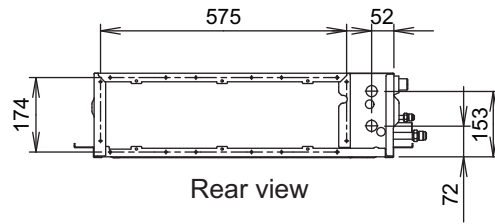

■ Model: ARXG18KSLAP

Unit: mm

4-5 UNIT
MULTI-SPLIT TYPE

4-5 UNIT
MULTI-SPLIT TYPE

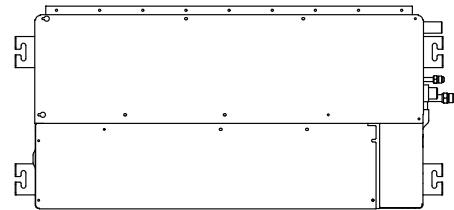
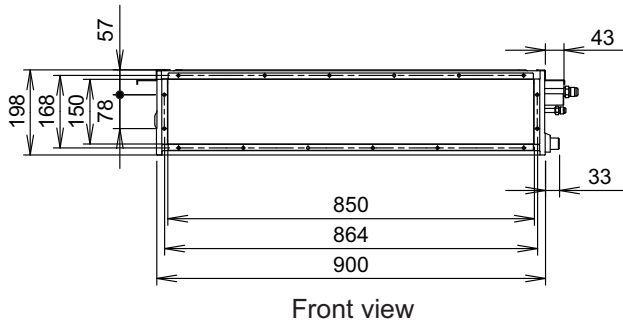
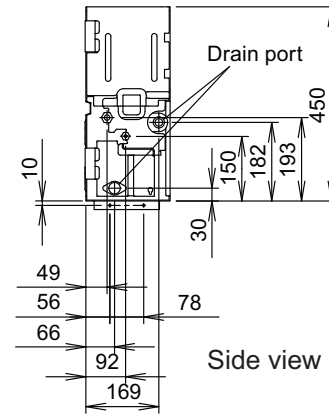
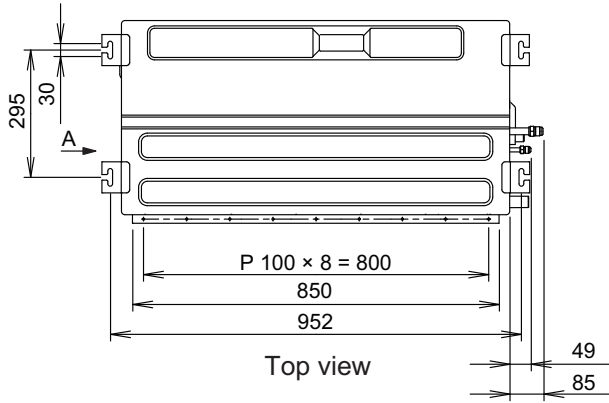
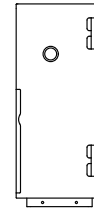
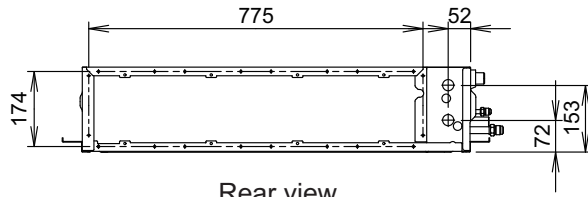

● Installation space requirement

Provide sufficient installation space for product safety.

Unit: mm

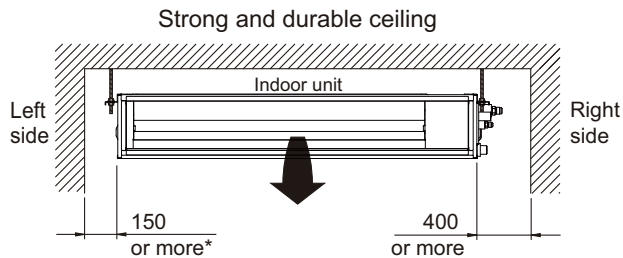

*: 400 or more when drain from drain pipe

• When intaking air from back:

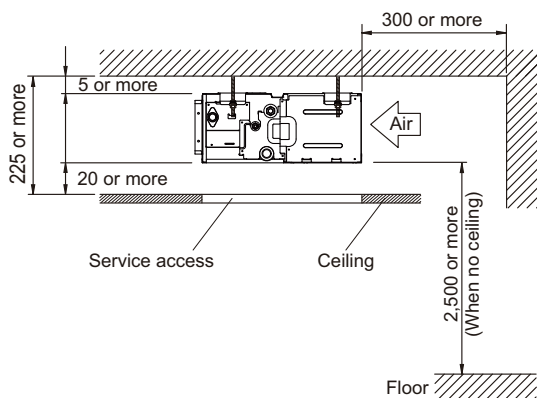

• When intaking air from bottom:

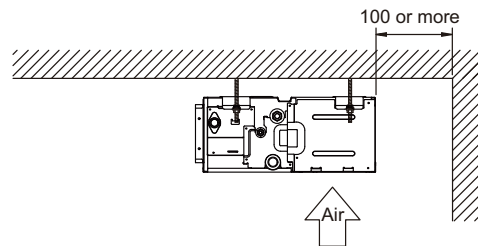

● Maintenance space requirement

For future maintenance and service access, provide sufficient maintenance space.

NOTE: Do not place any wiring or illumination in the maintenance space, as they will impede service.

Unit: mm

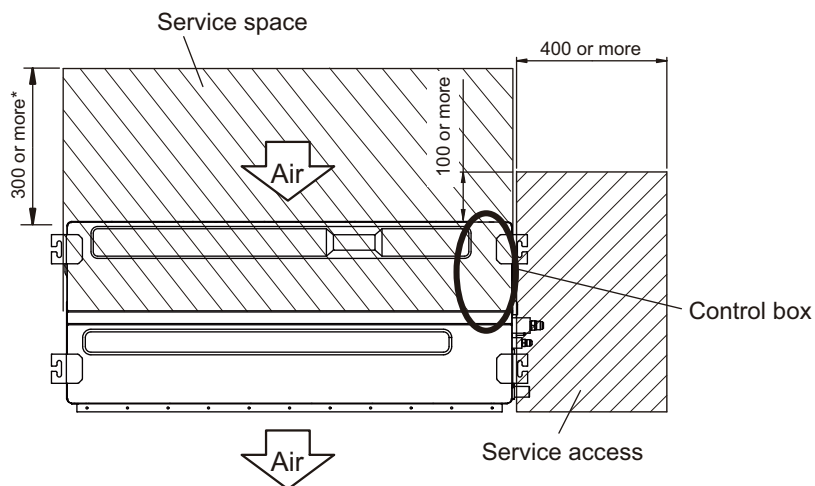

*: More than 100 when intaking air from bottom

Top view

3-3. Slim duct type

■ Models: ARXG07KLLAP, ARXG09KLLAP, ARXG12KLLAP, and ARXG14KLLAP

Unit: mm

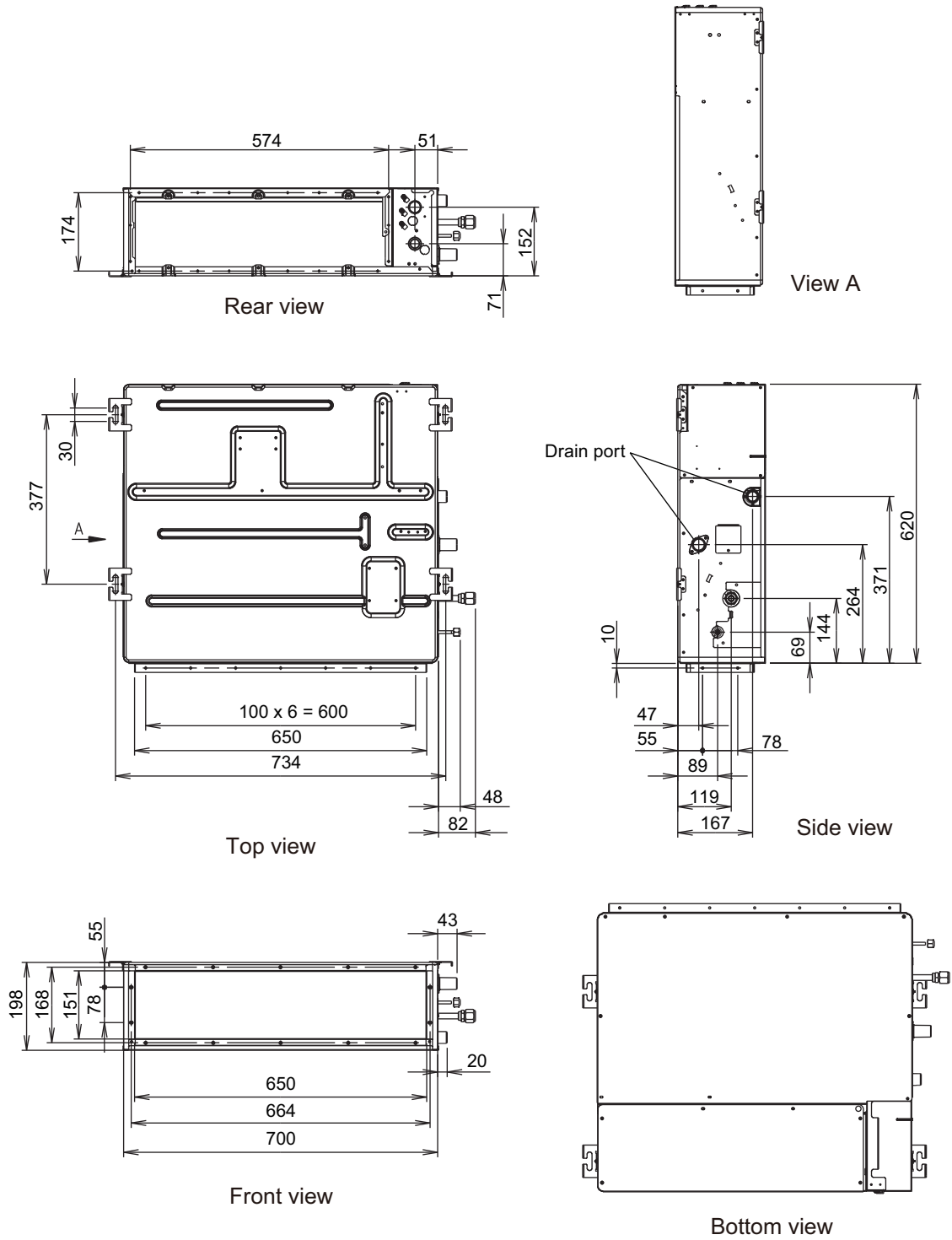

■ Model: ARXG18KLLAP

Unit: mm

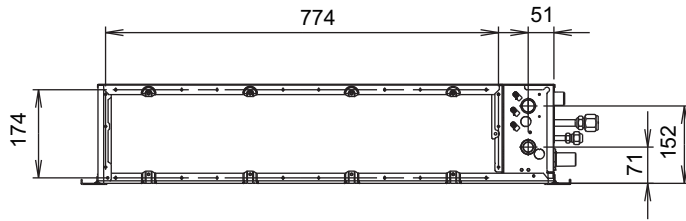

Rear view

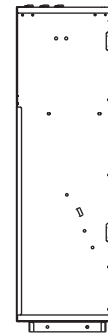

View A

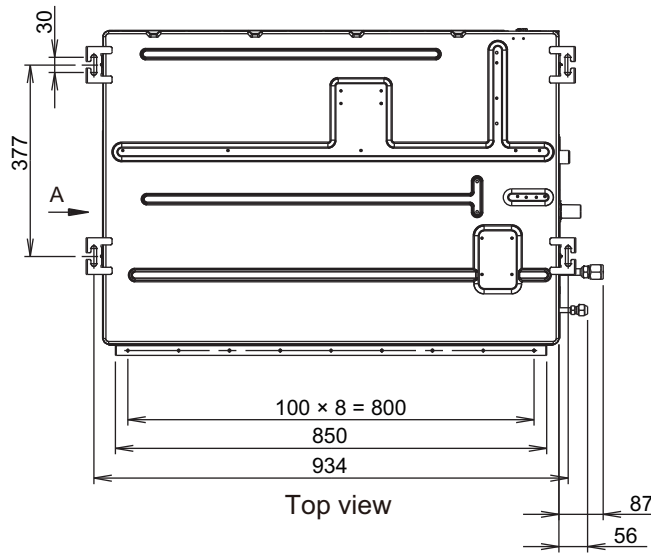

Top view

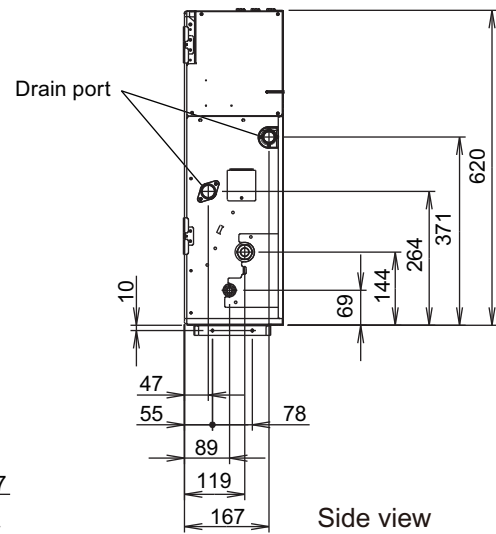

Side view

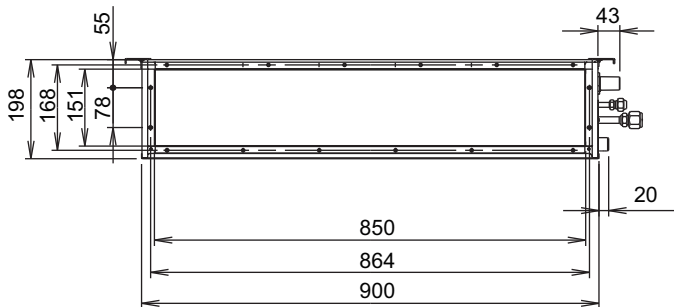

Front view

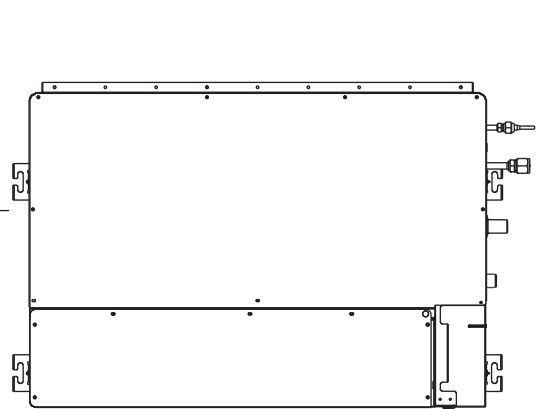

Bottom view

● Installation space requirement

Provide sufficient installation space for product safety.

In ceiling-concealed installations:

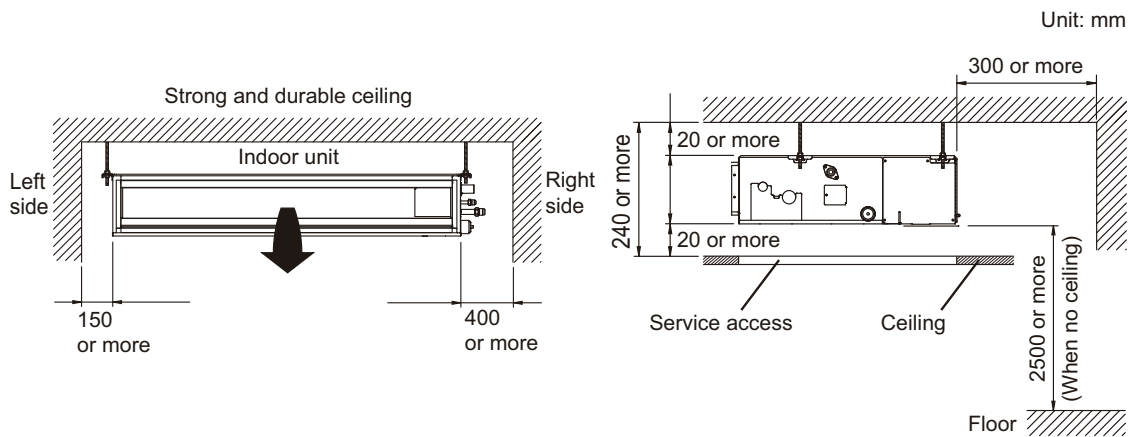

● Maintenance space requirement

For future maintenance and service access, provide sufficient maintenance space.

NOTE: Do not place any wiring or illumination in the maintenance space, as they will impede service.

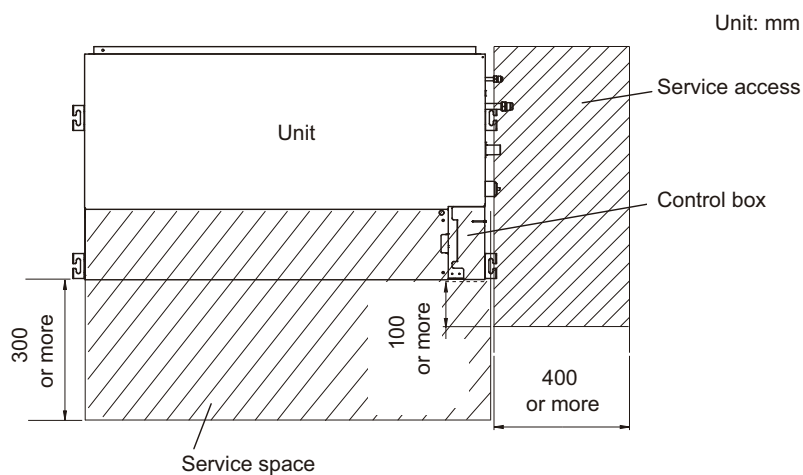

3-4. Medium static pressure duct type

■ Model: ARXG22KMLB

Unit: mm

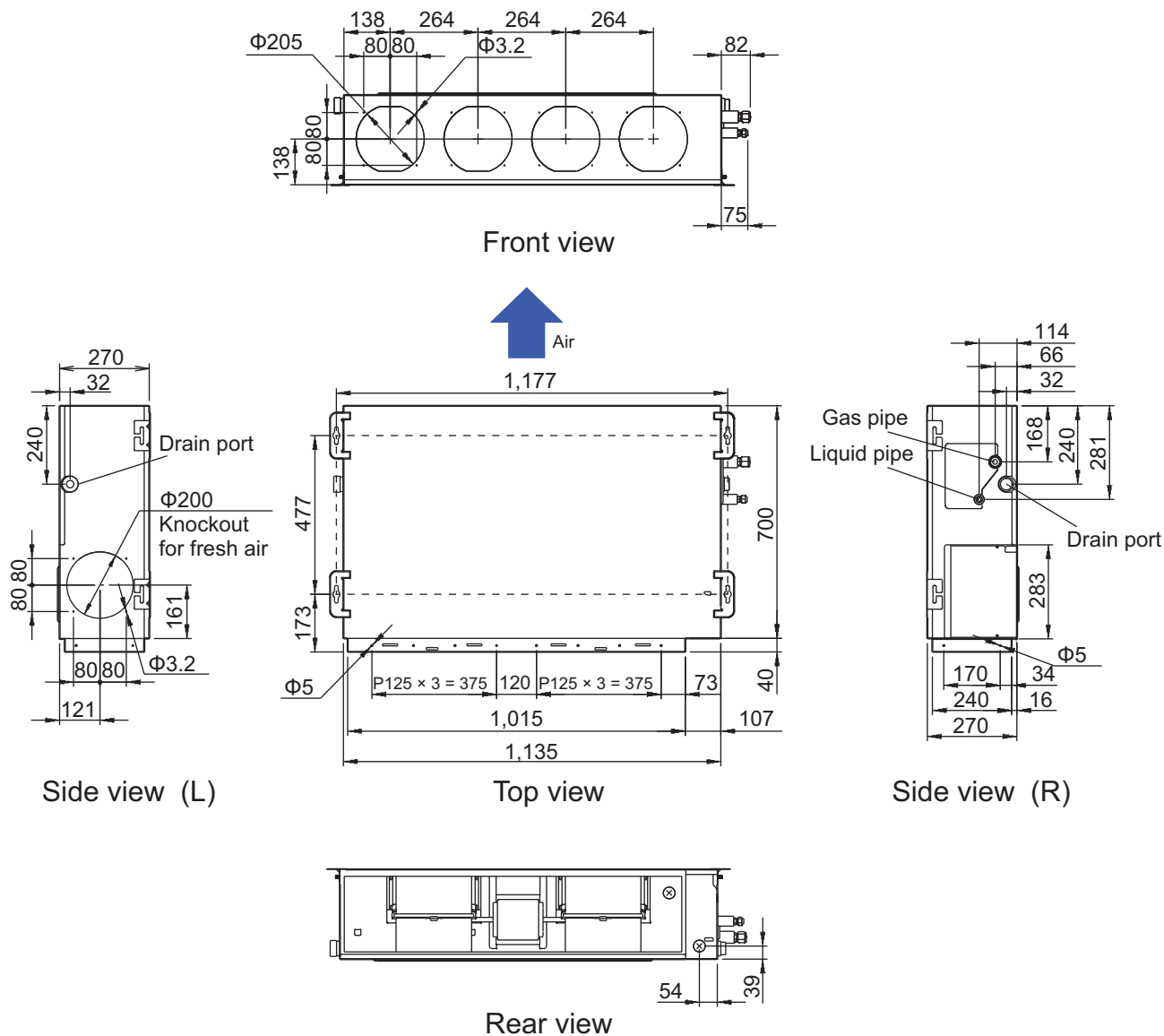

● Installation space requirement

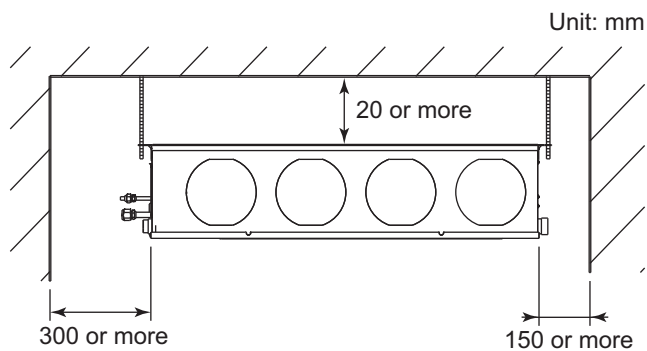

● Maintenance space requirement

Unit: mm

- Provide a service access for maintenance purposes.

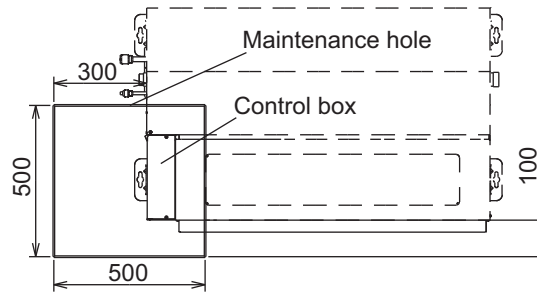

- The service access necessary for fan units and filter maintenance.

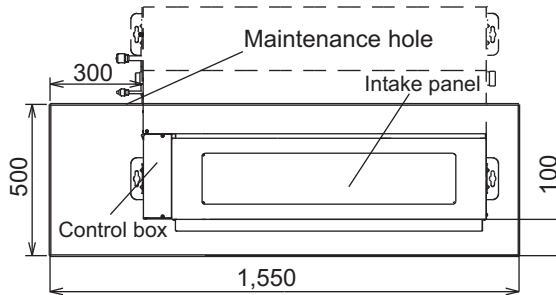

- When using a square duct

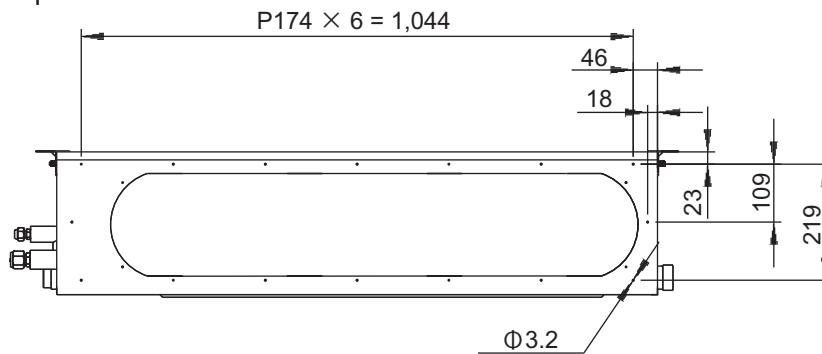

- Bottom air intake hole

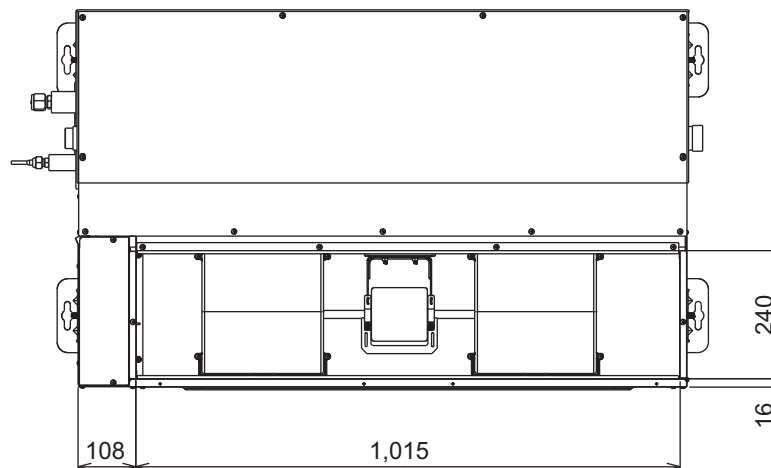

3-5. Wall mounted type

■ Models: ASYG07KGTB, ASYG09KGTB, ASYG12KGTB, and ASYG14KGTB

Unit: mm

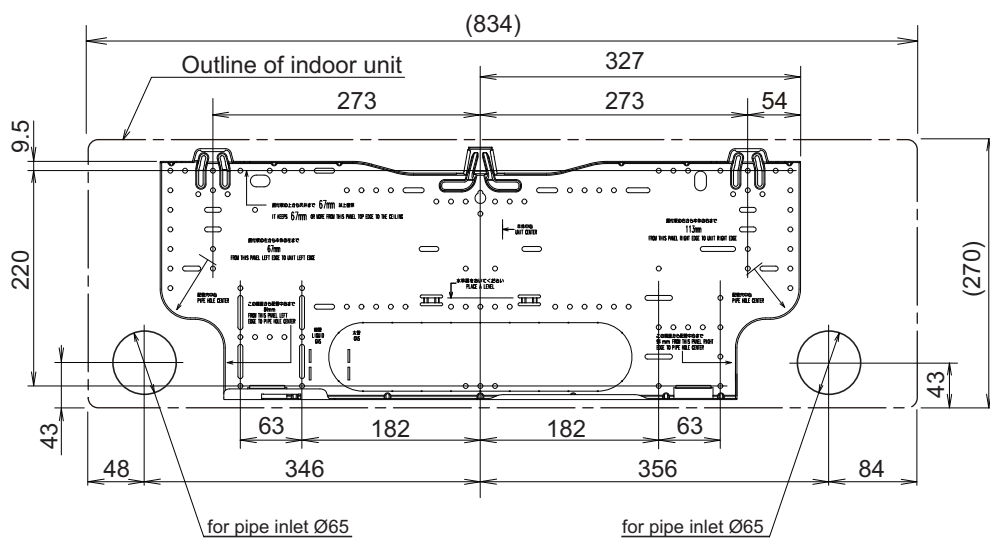
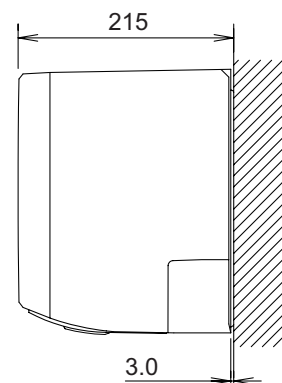
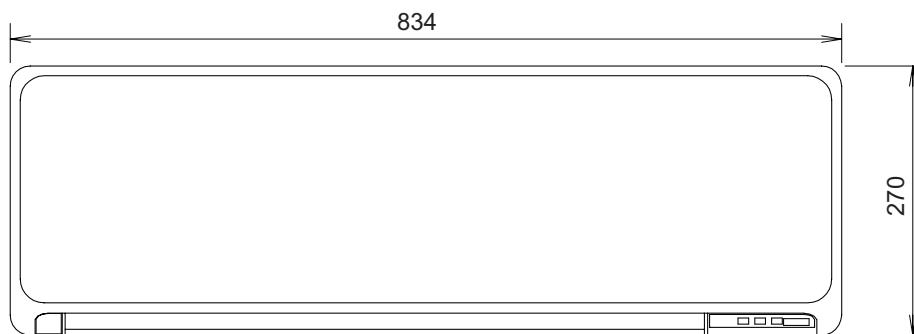

● Installation space requirement

Provide sufficient installation space for product safety.

Unit: mm

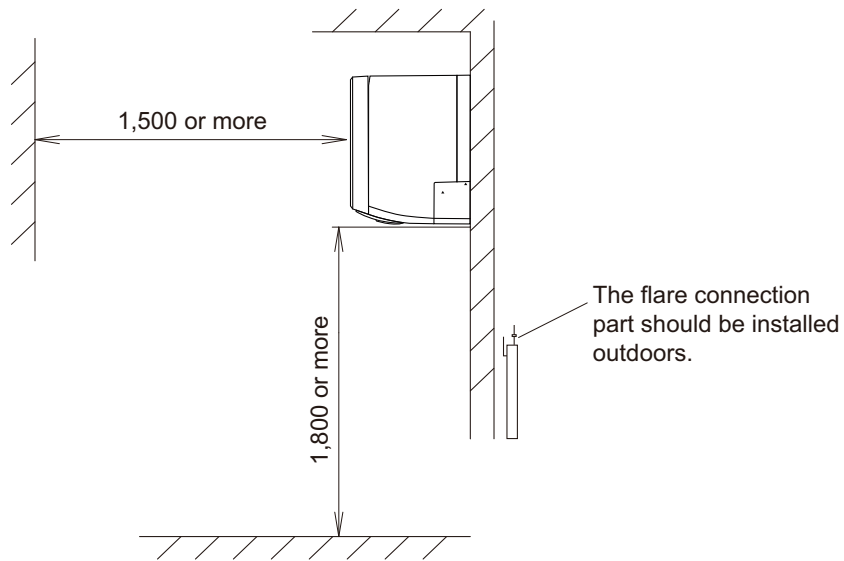
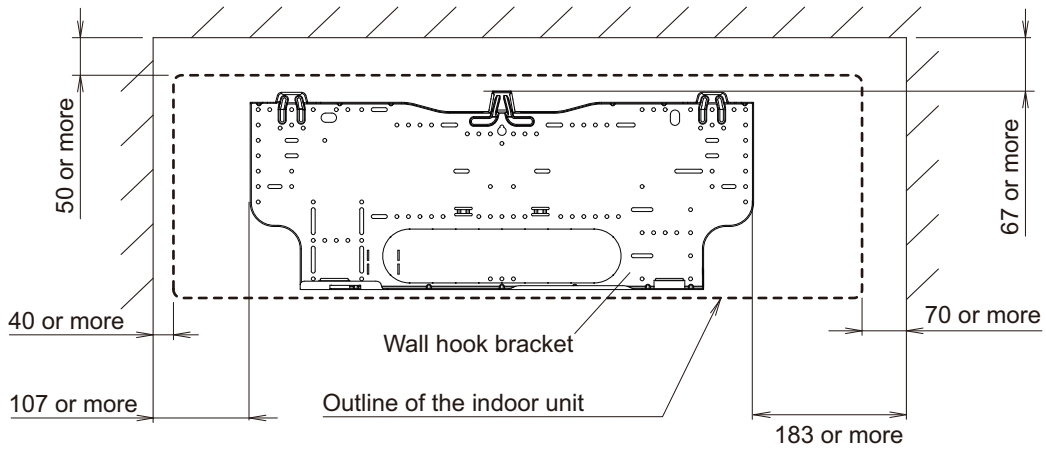

■ Models: ASYG18KMTB, ASYG22KMTB, and ASYG24KMTB

Unit: mm

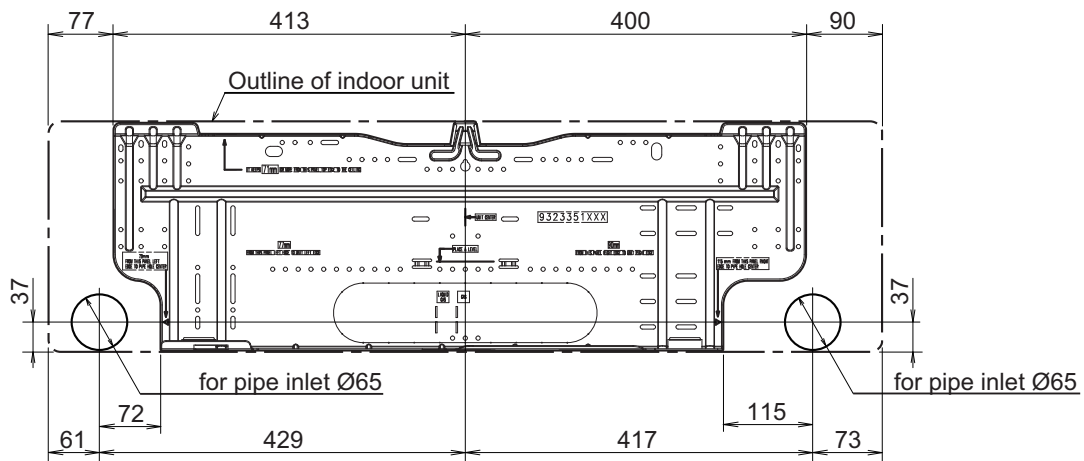
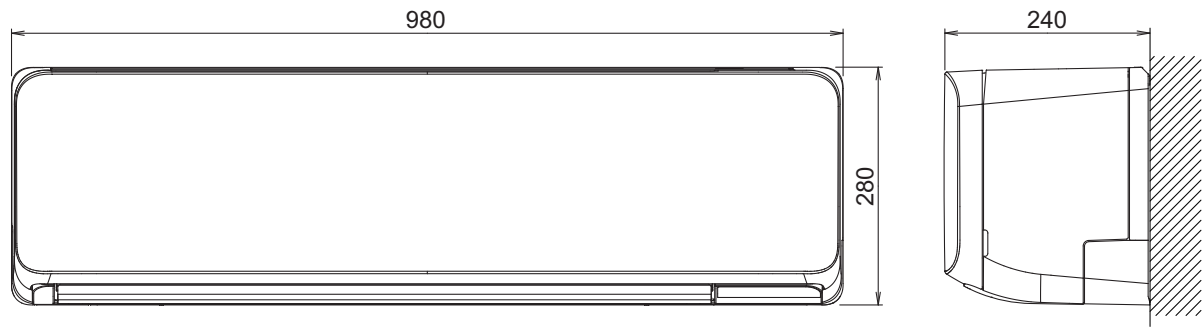

● Installation space requirement

Provide sufficient installation space for product safety.

Unit: mm

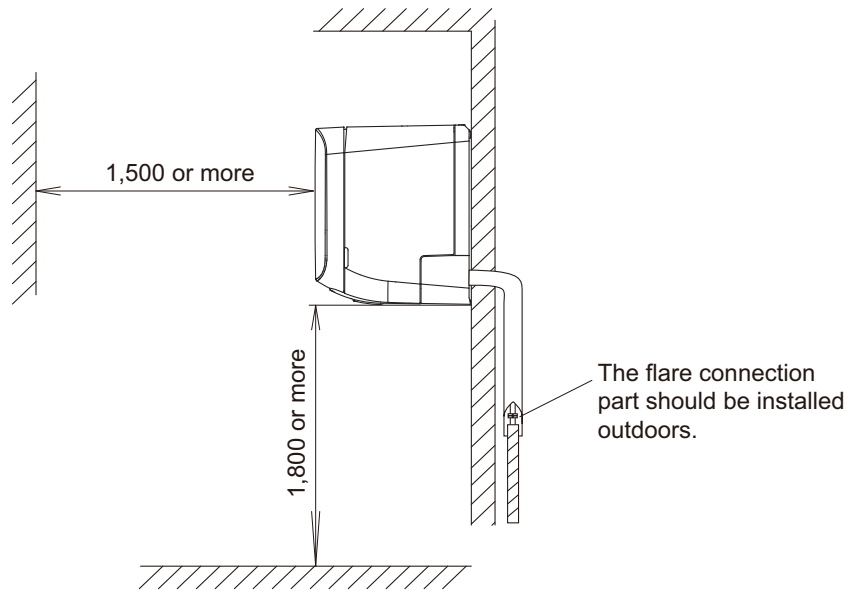
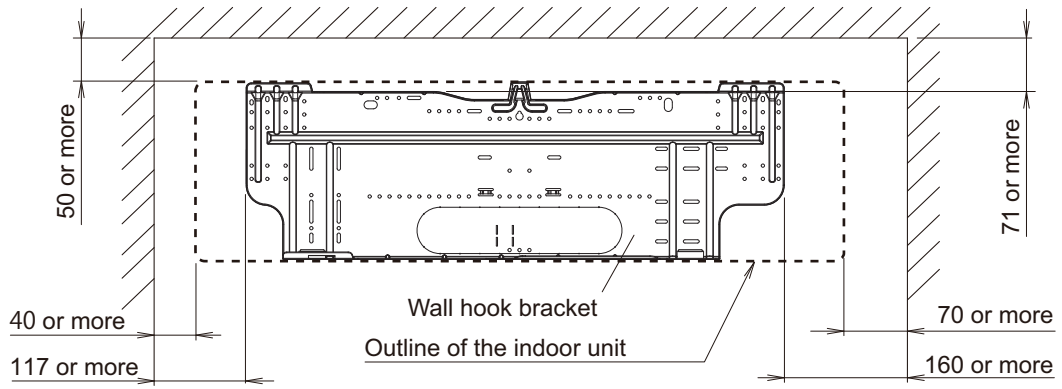

■ Models: ASYG07KMTB, ASYG09KMTB, ASYG12KMTB, ASYG14KMTB, ASYG07KMCC, ASYG09KMCC, ASYG12KMCC, and ASYG14KMCC

Unit: mm

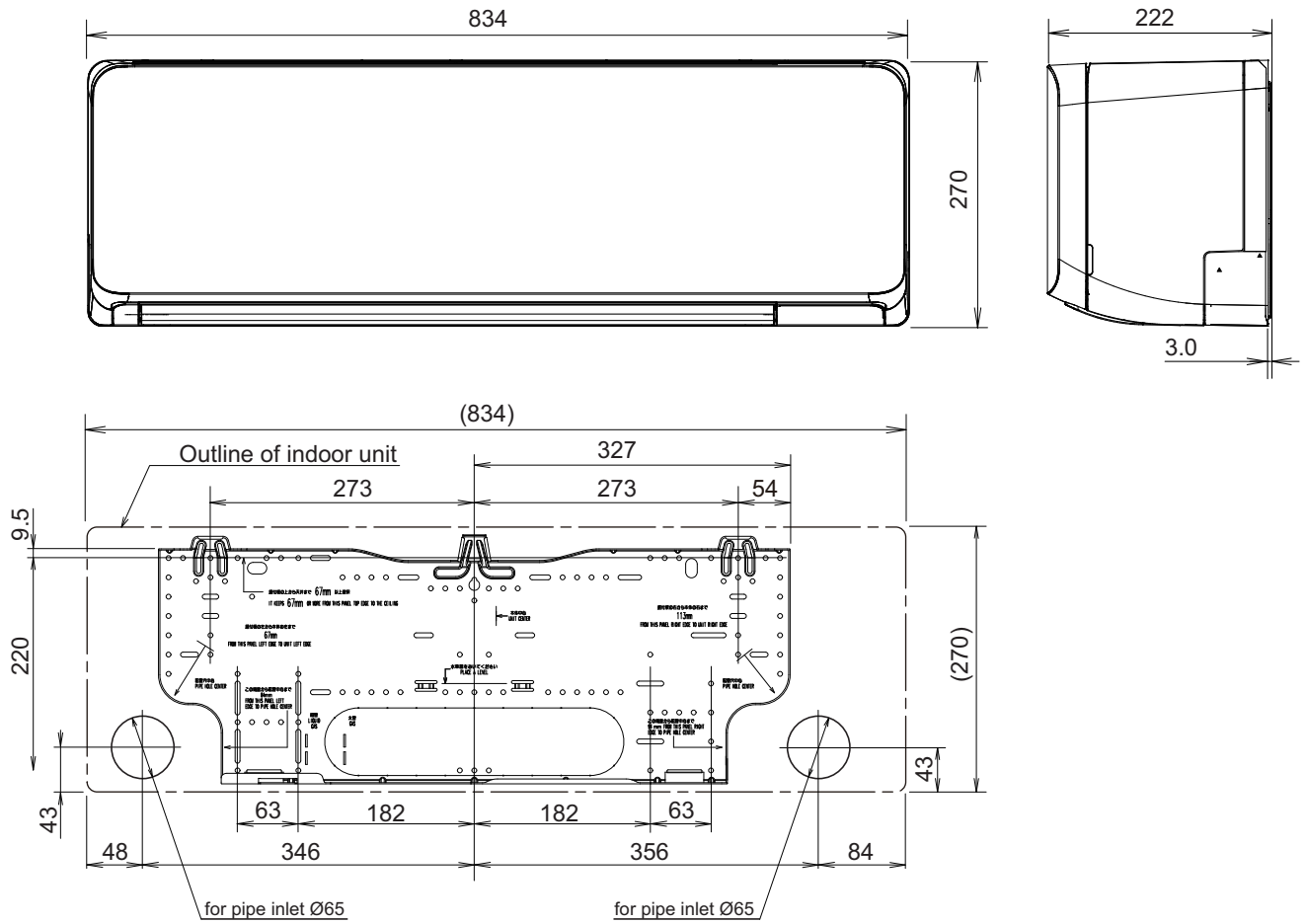

● Installation space requirement

Provide sufficient installation space for product safety.

Unit: mm

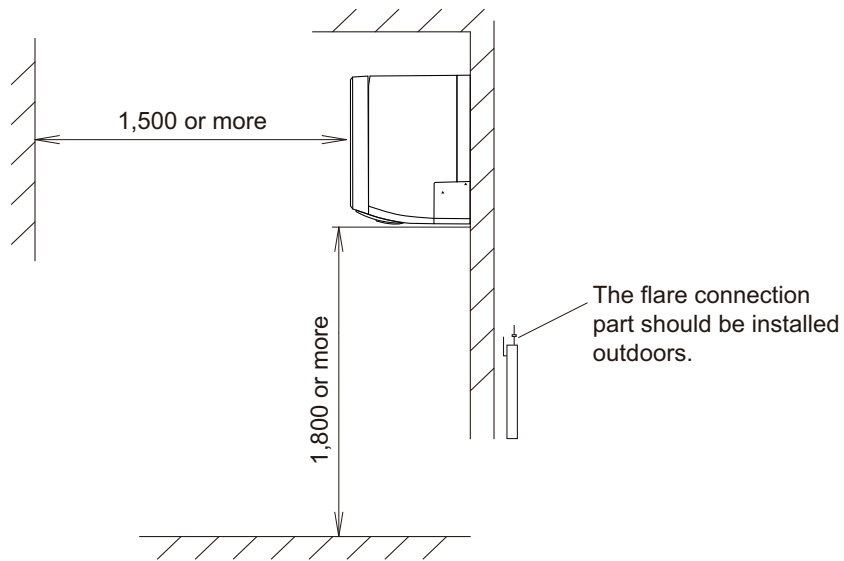
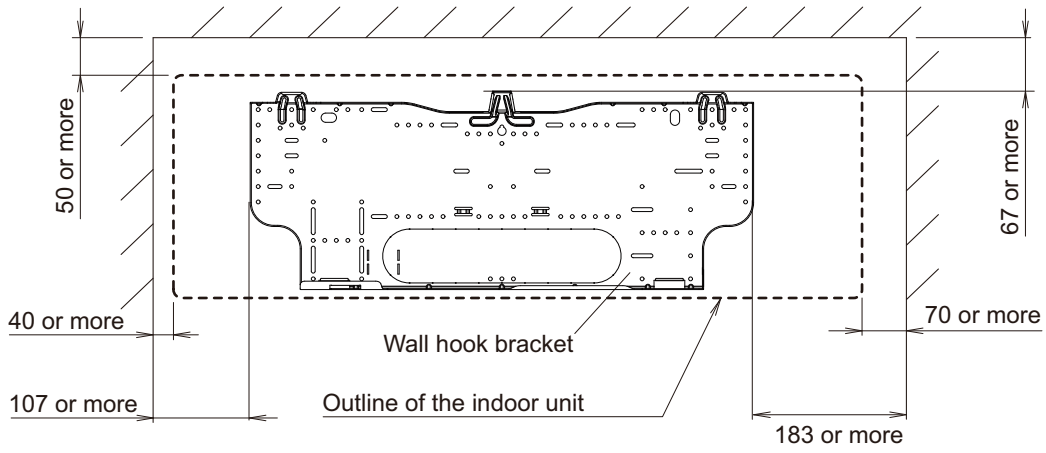

■ Models: ASYG07KETA, ASYG09KETA, ASYG12KETA, ASYG14KETA, ASYG07KETA-B, ASYG09KETA-B, ASYG12KETA-B, and ASYG14KETA-B

Unit: mm

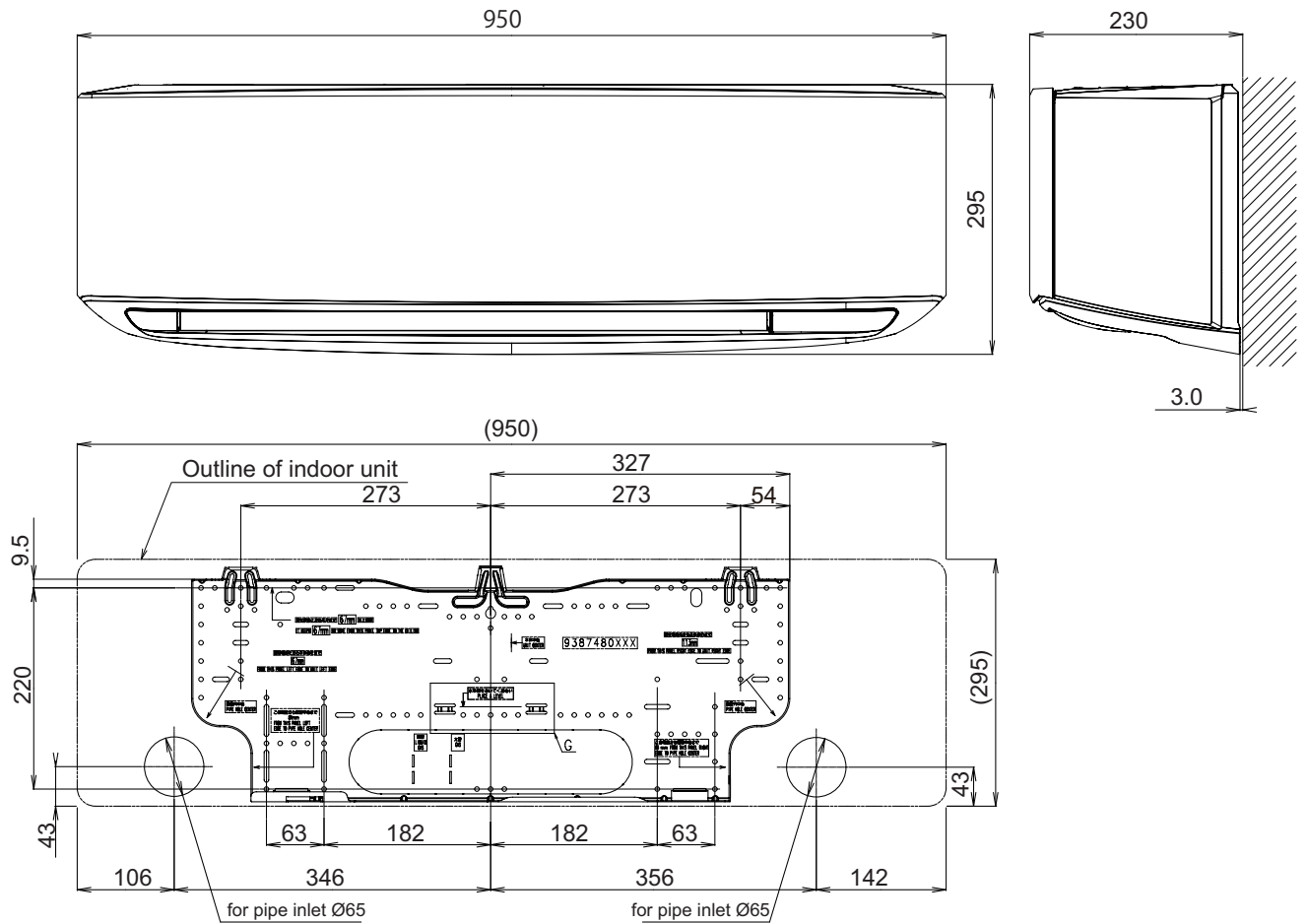

● Installation space requirement

Provide sufficient installation space for product safety.

Unit: mm

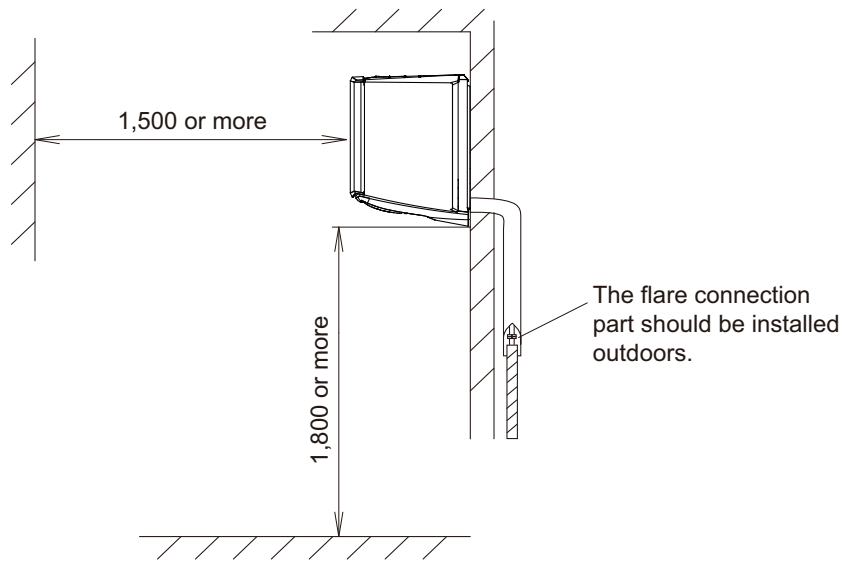
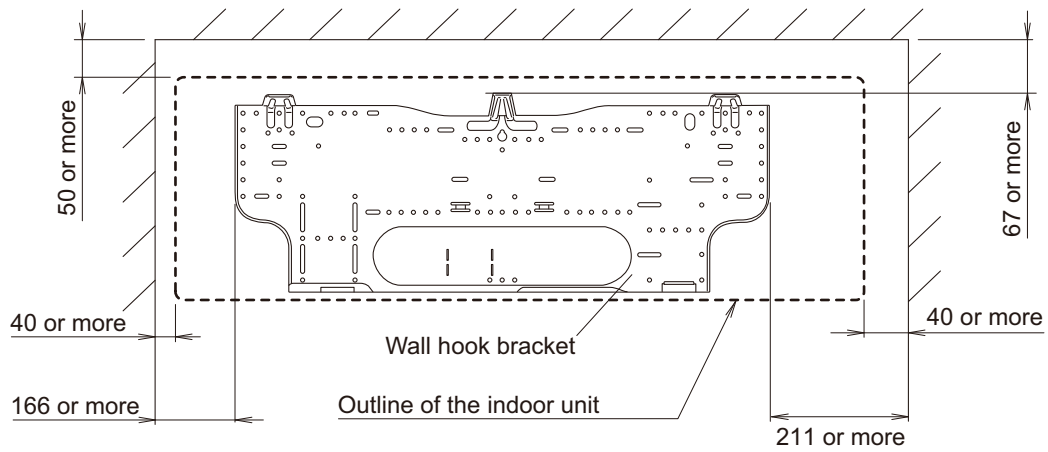

3-6. Ceiling type

■ Models: ABYG18KRTA and ABYG22KRTA

Unit: mm

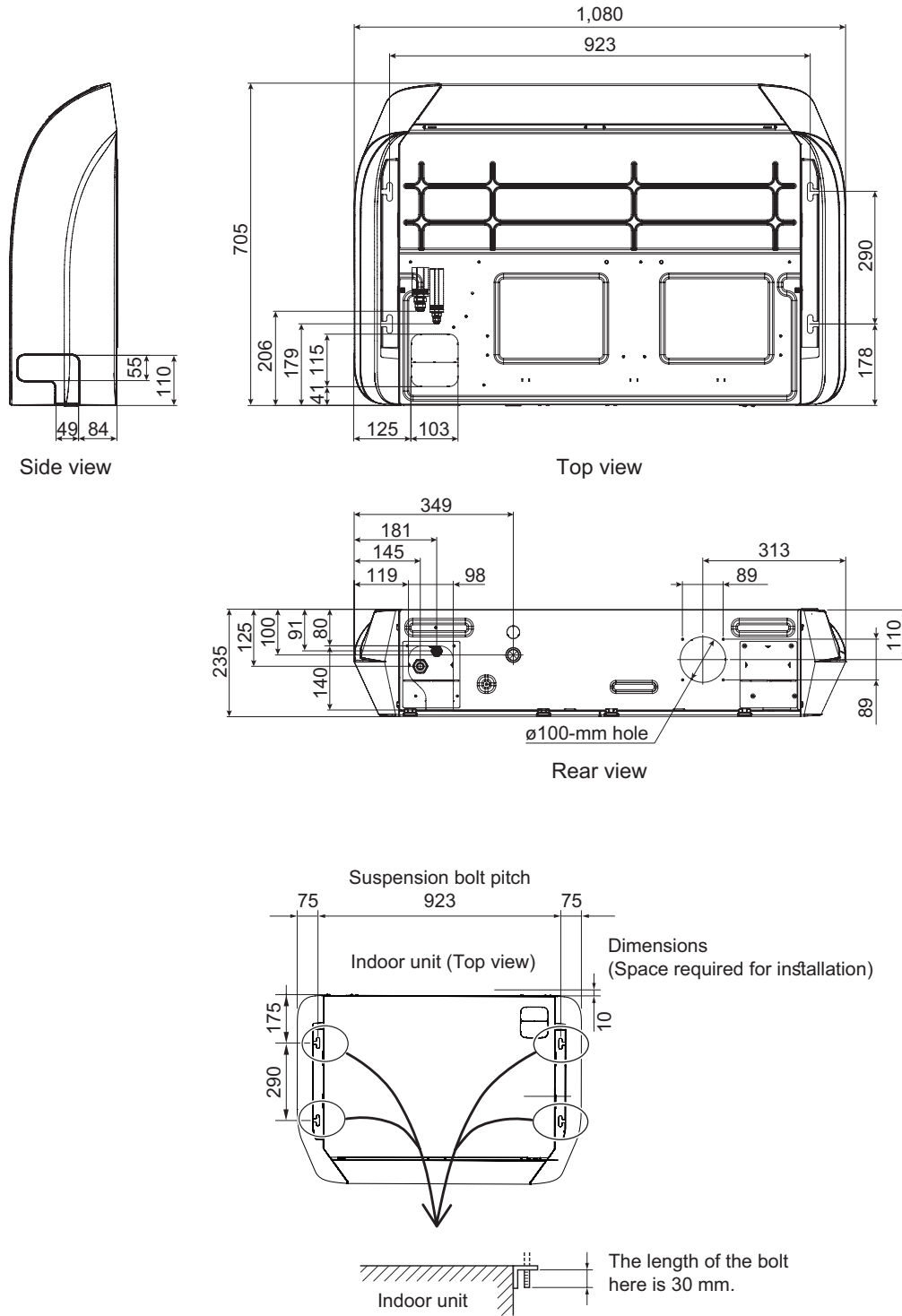

Installation space requirement

Unit: mm

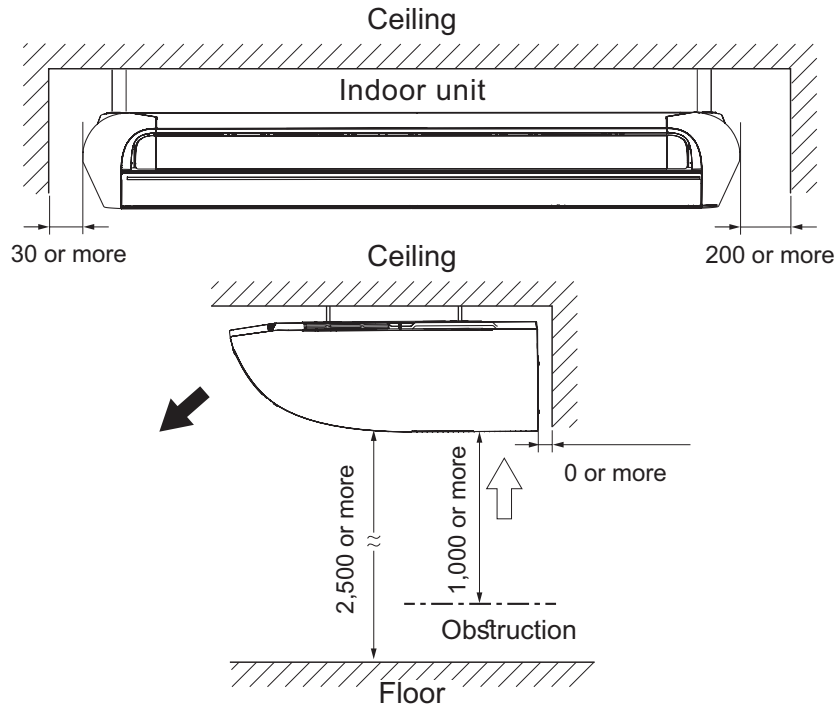

Required ceiling height varies according to the ceiling mode setting of function setting No. 20.

Ceiling height (m)		
Ceiling mode	Standard	High ceiling
18, 22 models	2.7	3.5

3-7. Floor type

■ Models: AGYG09KVCA, AGYG12KVCA, and AGYG14KVCA

Unit: mm

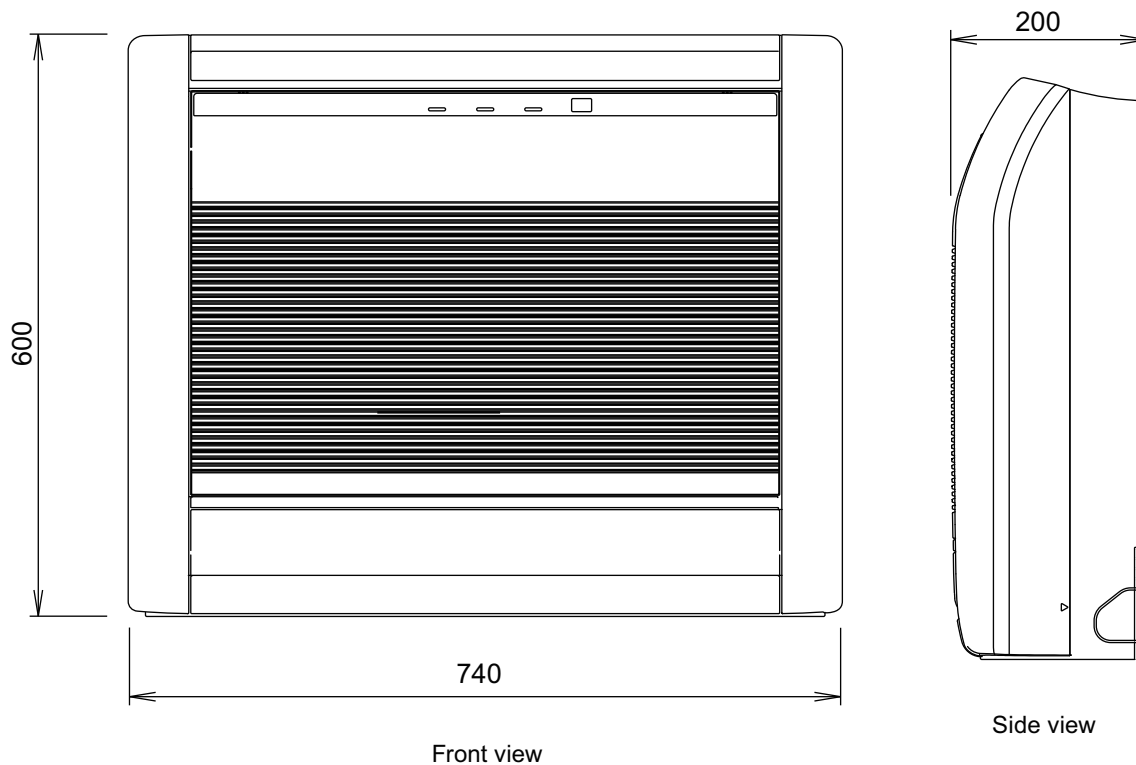

● Installation space

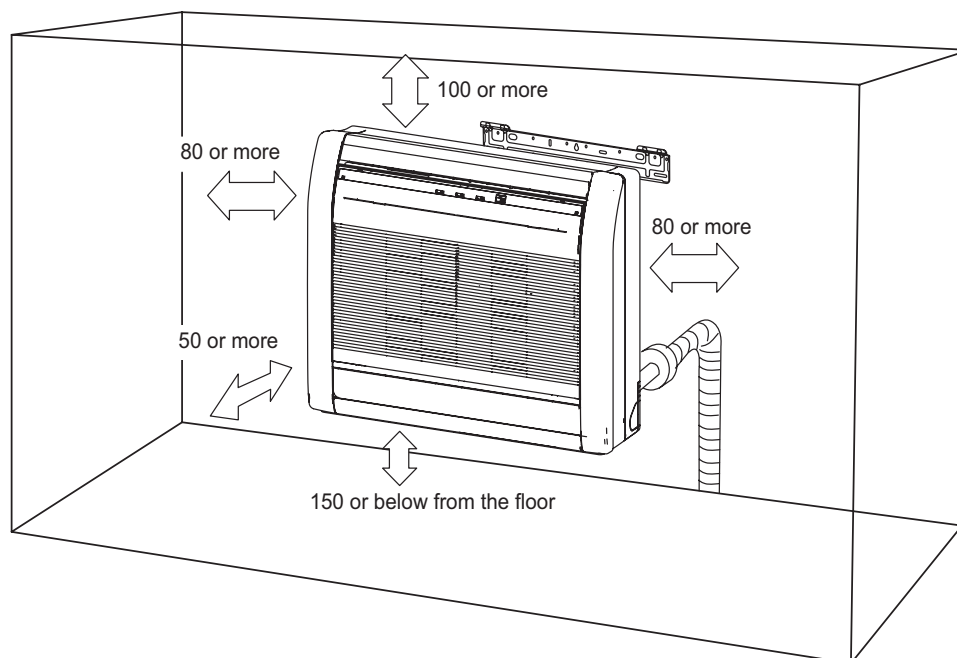

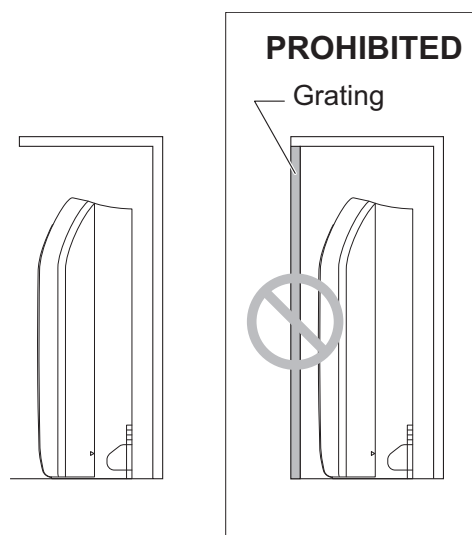

⚠ WARNING

- The appliance shall be installed, operated and stored in a room with a floor area larger than X m².

Amount of refrigerant charge M (kg)	Minimum room area X (m ²)
$M \leq 1.22$	-
$1.22 < M \leq 1.23$	12.99
$1.23 < M \leq 1.50$	19.31
$1.50 < M \leq 1.75$	26.28
$1.75 < M \leq 2.0$	34.33
$2.0 < M \leq 2.5$	53.63
$2.5 < M \leq 3.0$	77.23
$3.0 < M \leq 3.5$	105.12
$3.5 < M \leq 4.0$	137.29

(IEC 60335-2-40)

4. Wiring diagrams

4-1. Compact cassette type

■ Models: AUXG07KVLA, AUXG09KVLA, AUXG12KVLA, AUXG14KVLA, AUXG18KVLA, and AUXG22KVLA

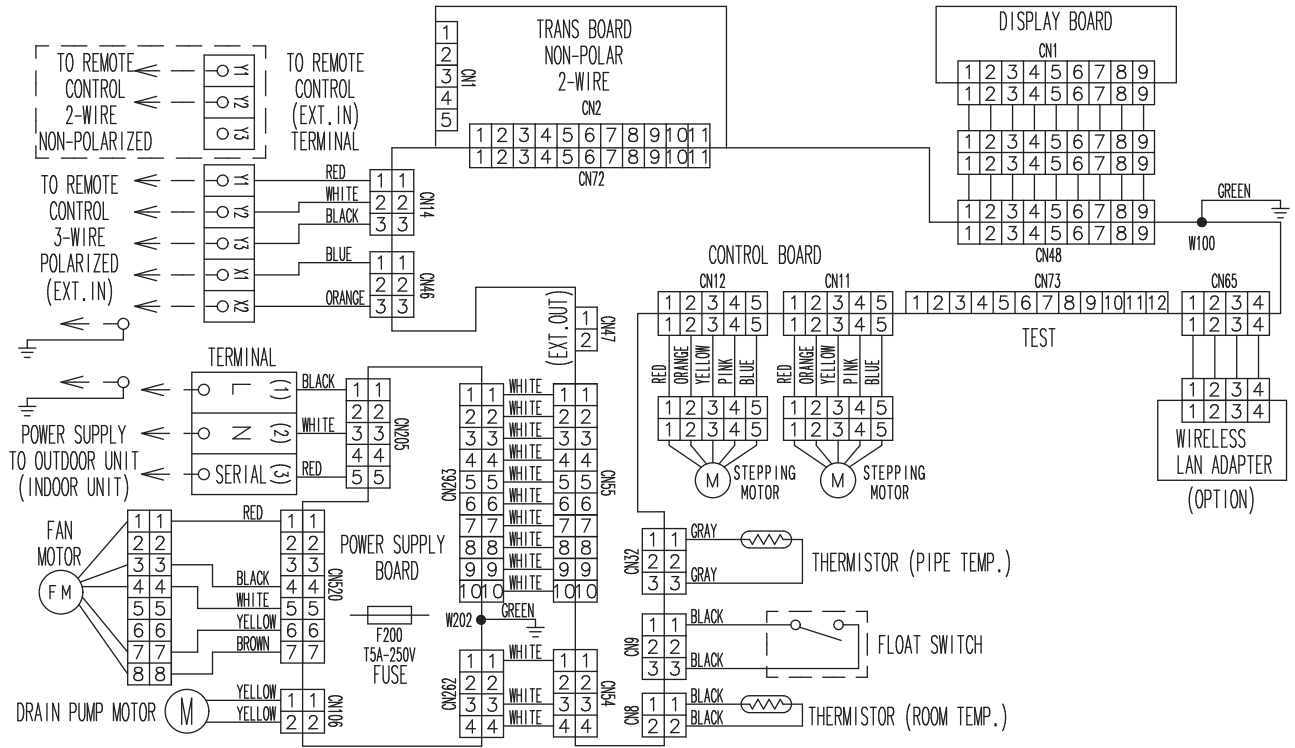

4-2. Mini duct type and Slim duct type

- Models: ARXG07KSLAP, ARXG09KSLAP, ARXG12KSLAP, ARXG14KSLAP, ARXG18KSLAP, ARXG07KLLAP, ARXG09KLLAP, ARXG12KLLAP, ARXG14KLLAP, and ARXG18KLLAP

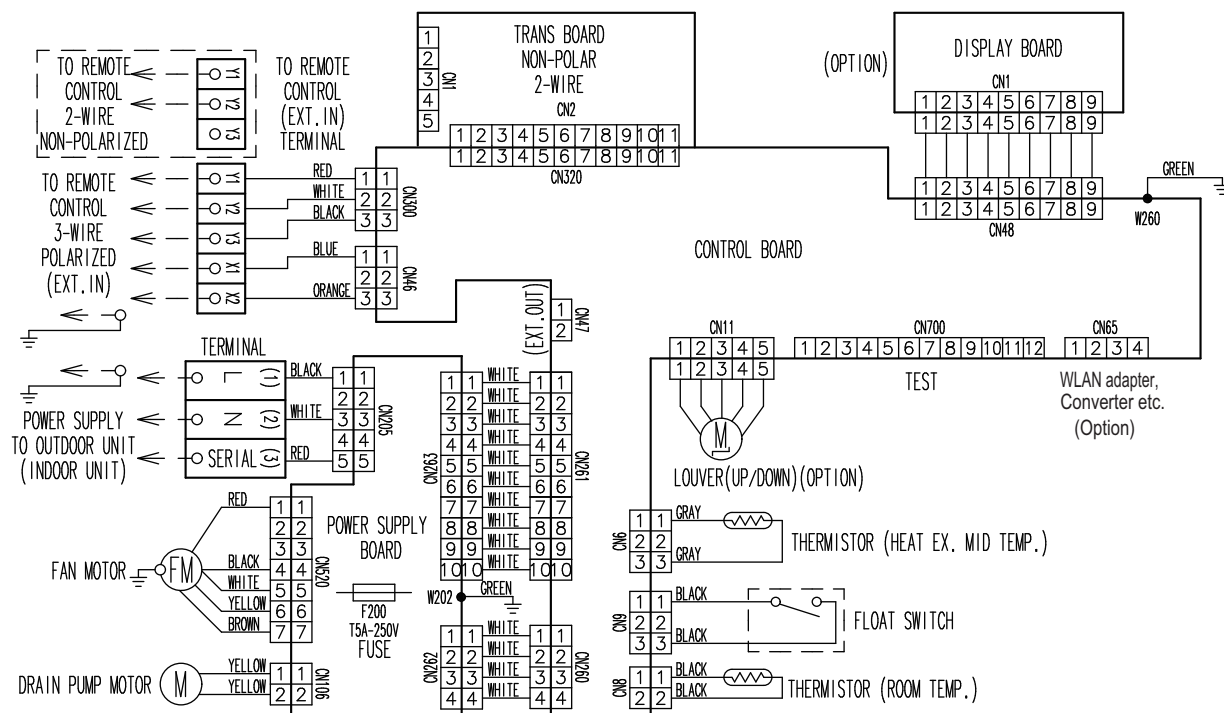

4-3. Medium static pressure duct type

Model: ARXG22KMLB

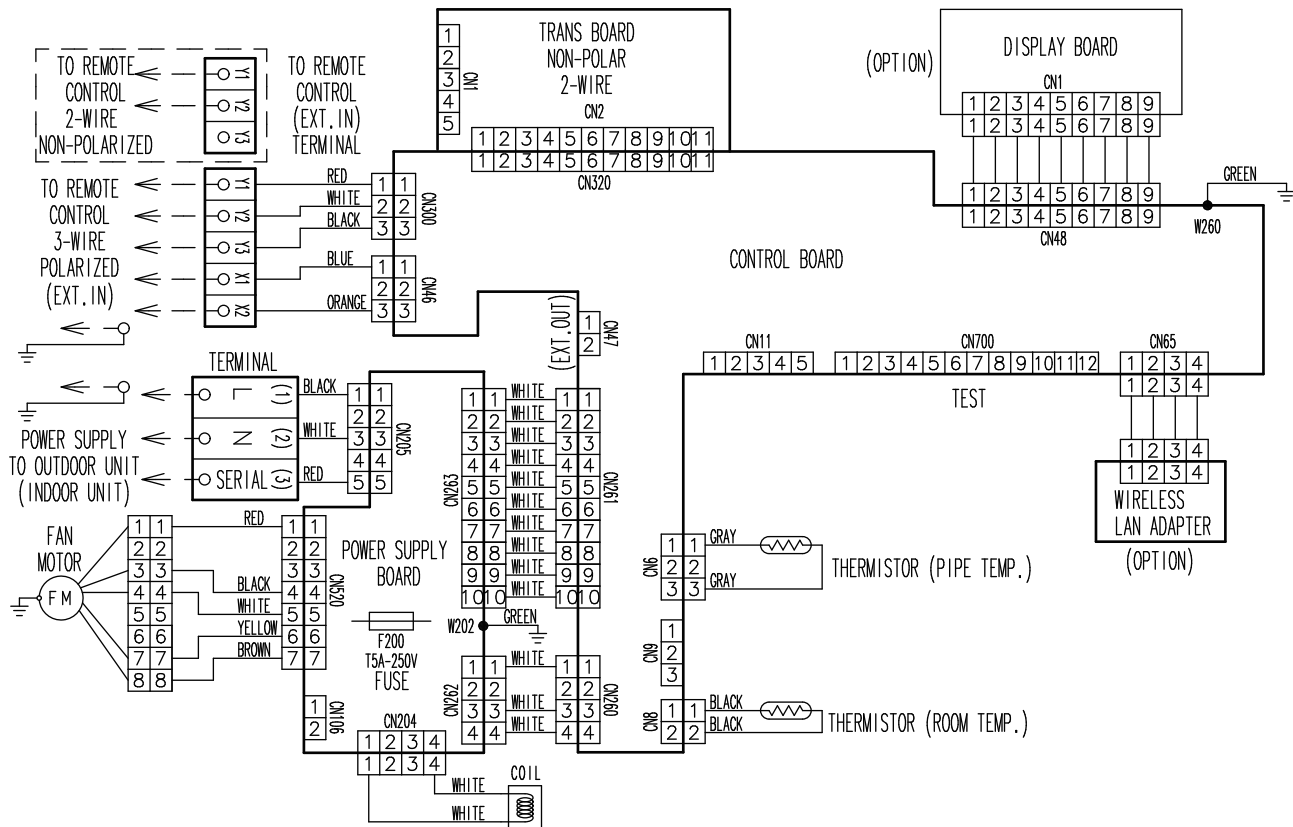

4-5 UNIT
MULTI-SPLIT TYPE

4-5 UNIT
MULTI-SPLIT TYPE

4-4. Wall mounted type

■ Models: ASYG07KGTB, ASYG09KGTB, ASYG12KGTB, and ASYG14KGTB

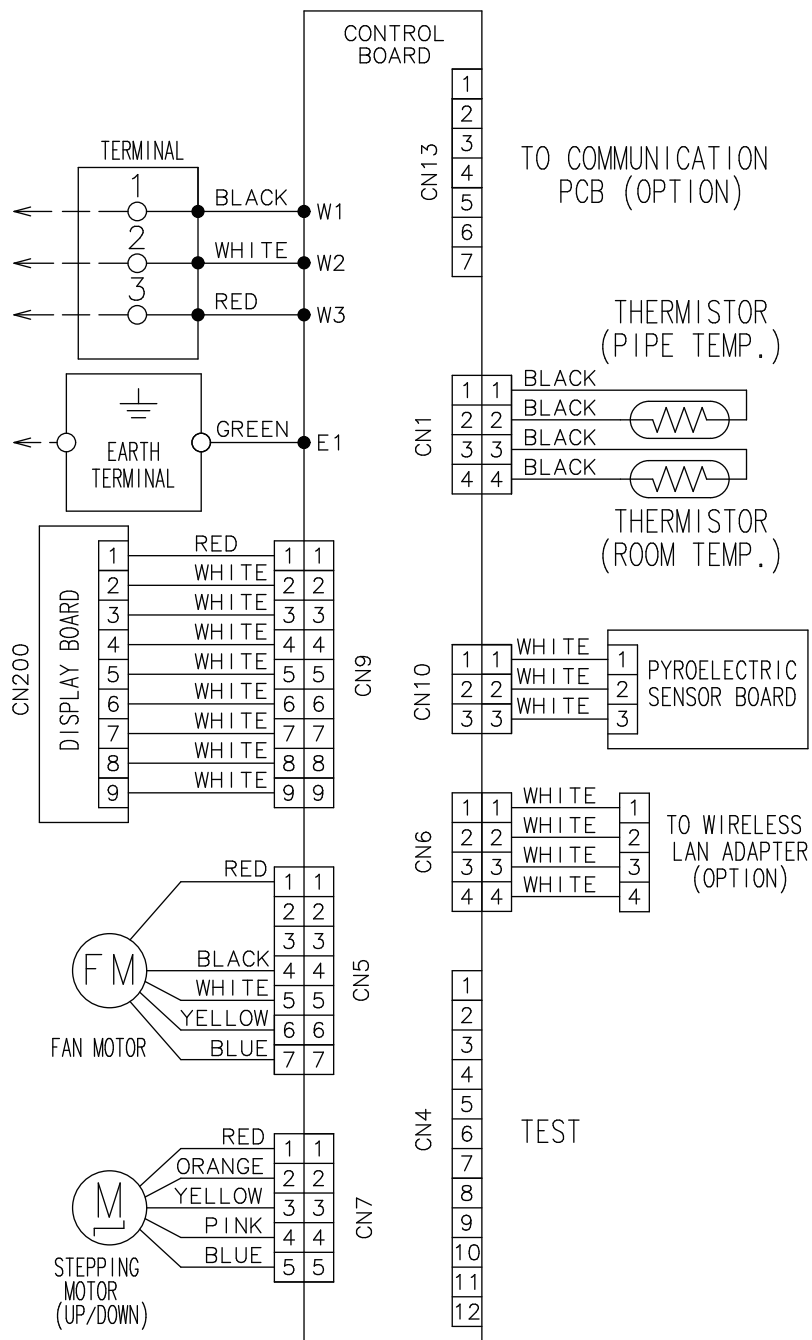

■ Models: ASYG18KMTB, ASYG22KMTB, and ASYG24KMTB

4-5 UNIT
MULTI-SPLIT TYPE

4-5 UNIT
MULTI-SPLIT TYPE

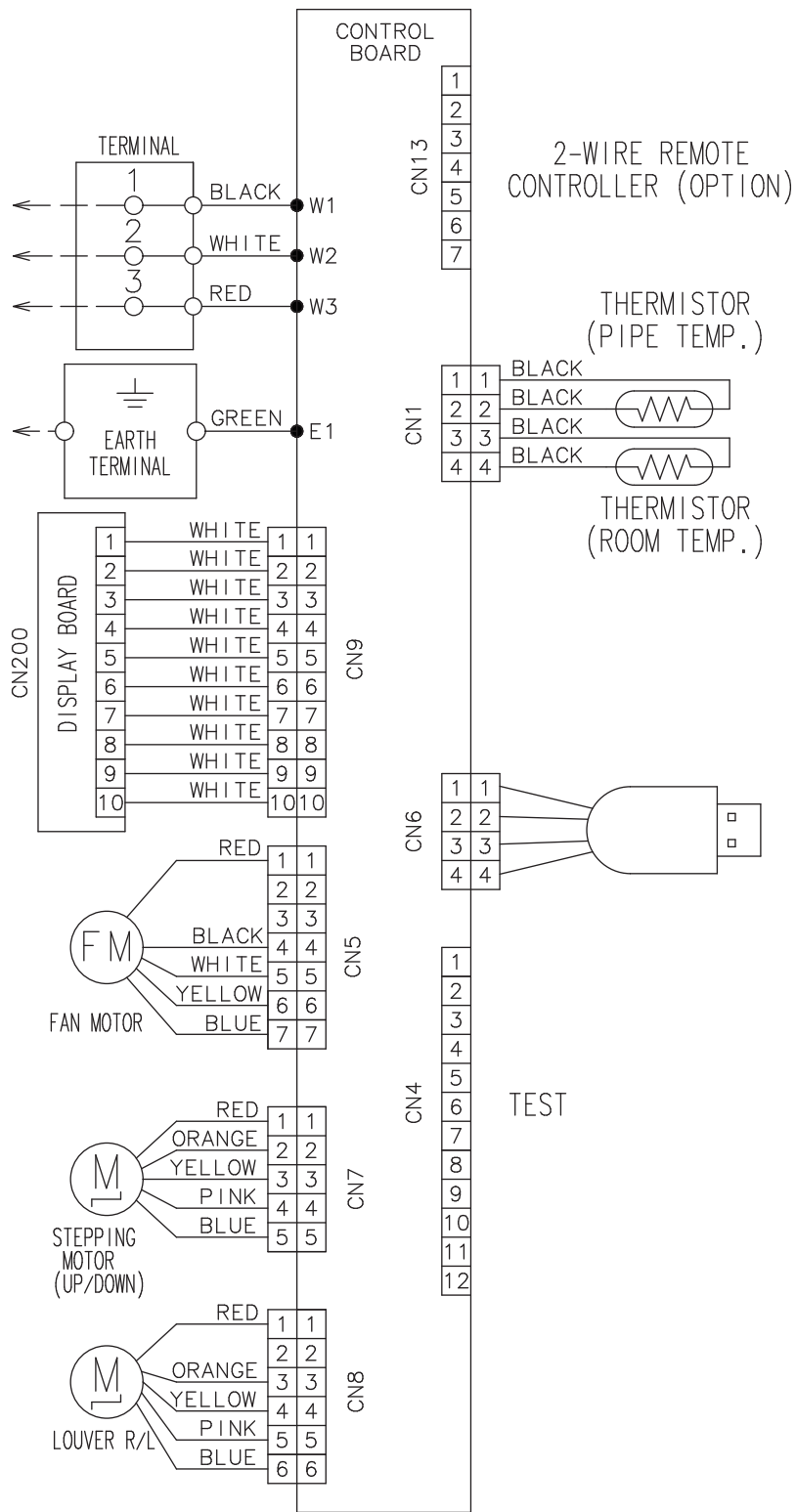

■ Models: ASYG07KMTB, ASYG09KMTB, ASYG12KMTB, and ASYG14KMTB

4-5 UNIT
MULTI-SPLIT TYPE

4-5 UNIT
MULTI-SPLIT TYPE

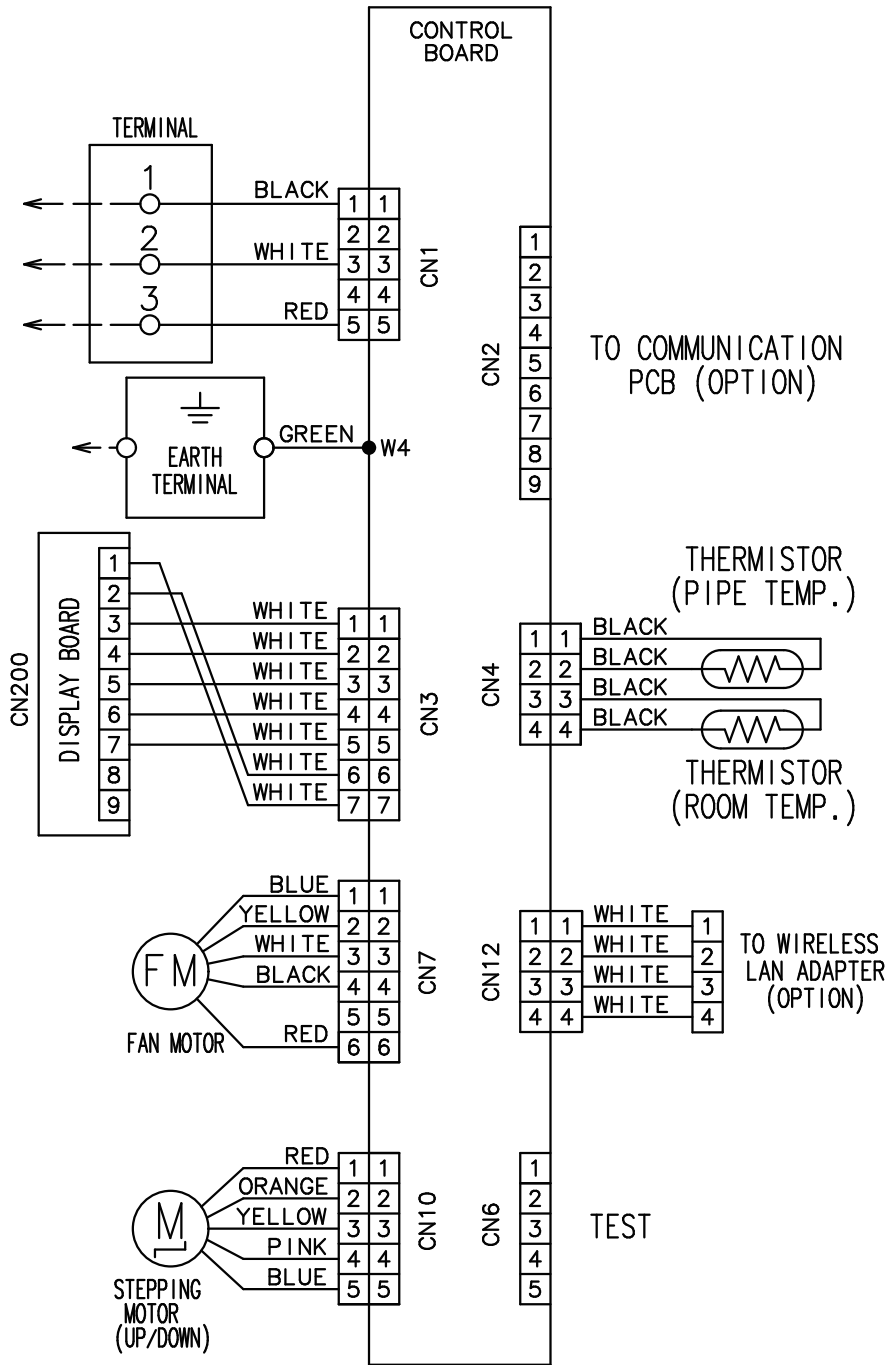

■ Models: ASYG07KMCC, ASYG09KMCC, ASYG12KMCC, and ASYG14KMCC

4-5 UNIT
MULTI-SPLIT TYPE

4-5 UNIT
MULTI-SPLIT TYPE

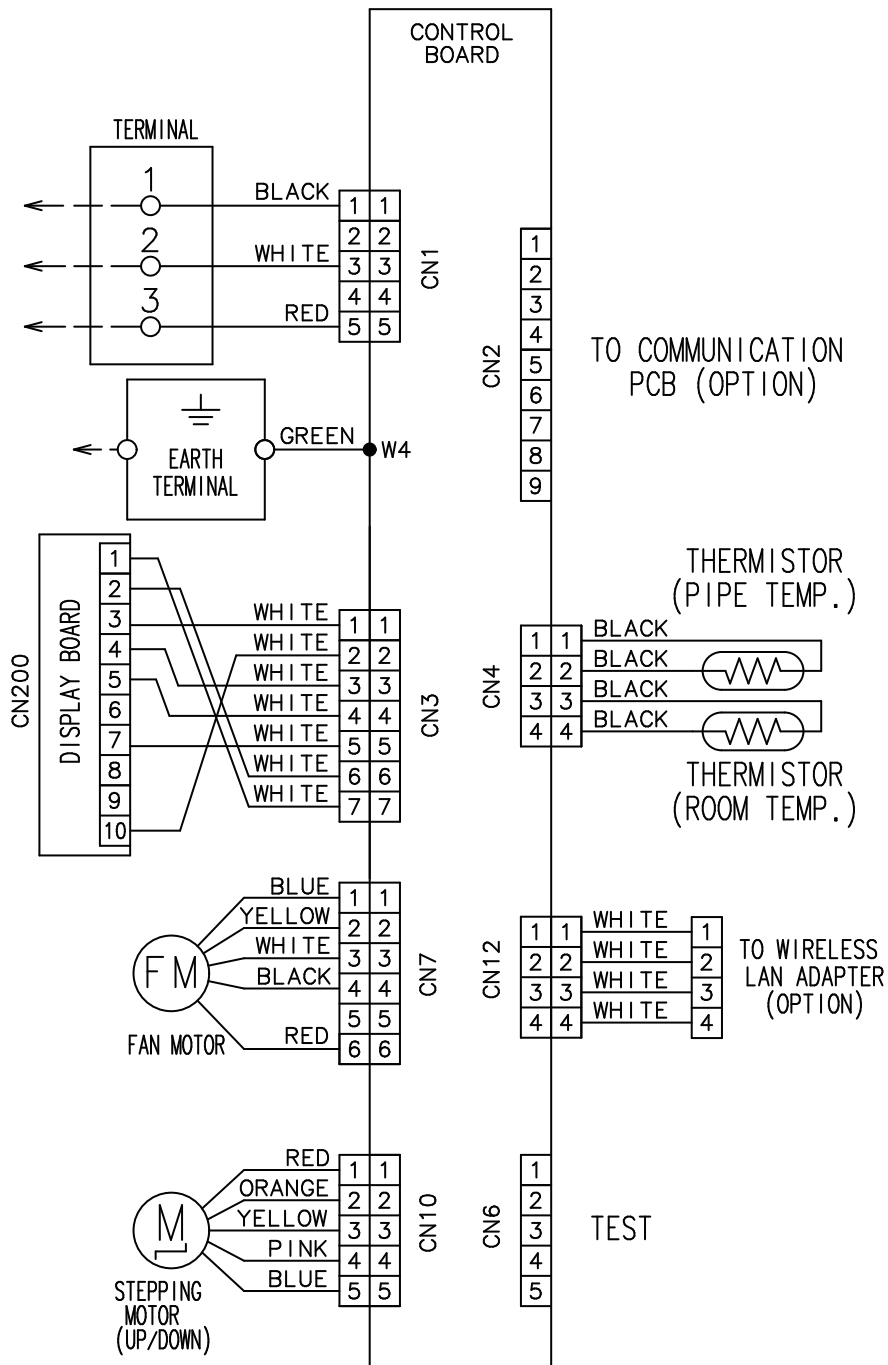

■ Models: ASYG07KETA, ASYG09KETA, ASYG12KETA, ASYG14KETA, ASYG07KETA-B, ASYG09KETA-B, ASYG12KETA-B, and ASYG14KETA-B

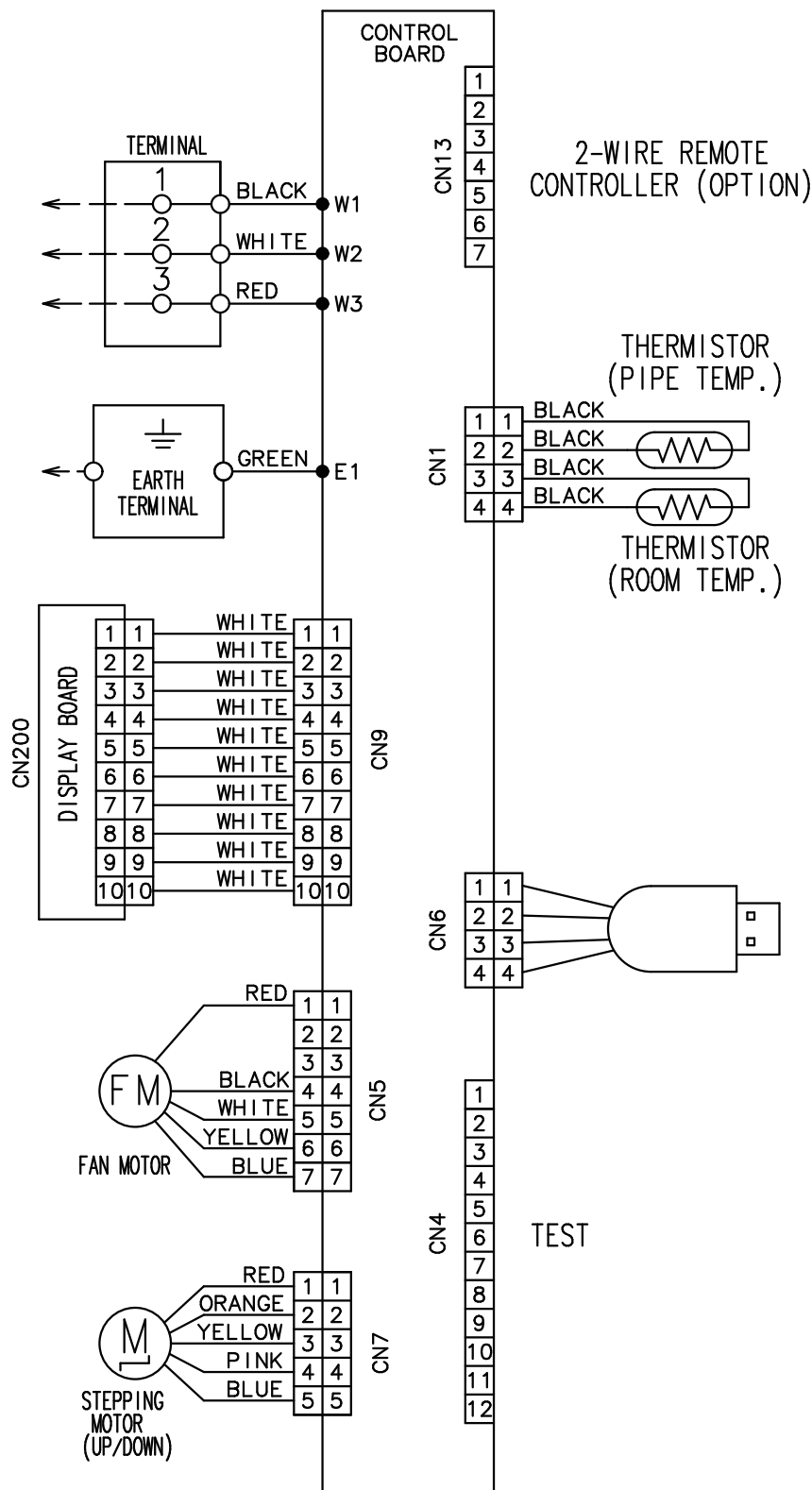

4-5. Ceiling type

Models: ABYG18KRTA and ABYG22KRTA

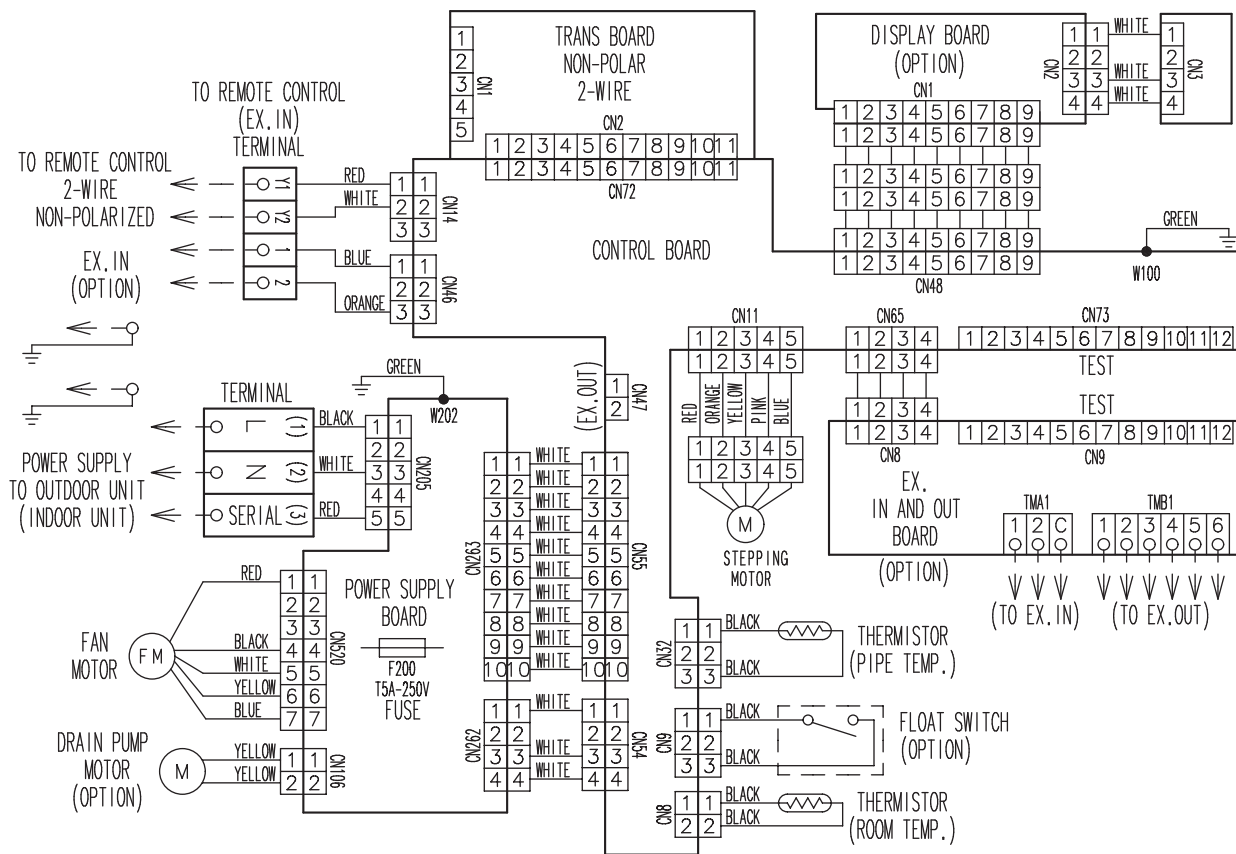

4-6. Floor type

Models: AGYG09KVCA, AGYG12KVCA, and AGYG14KVCA

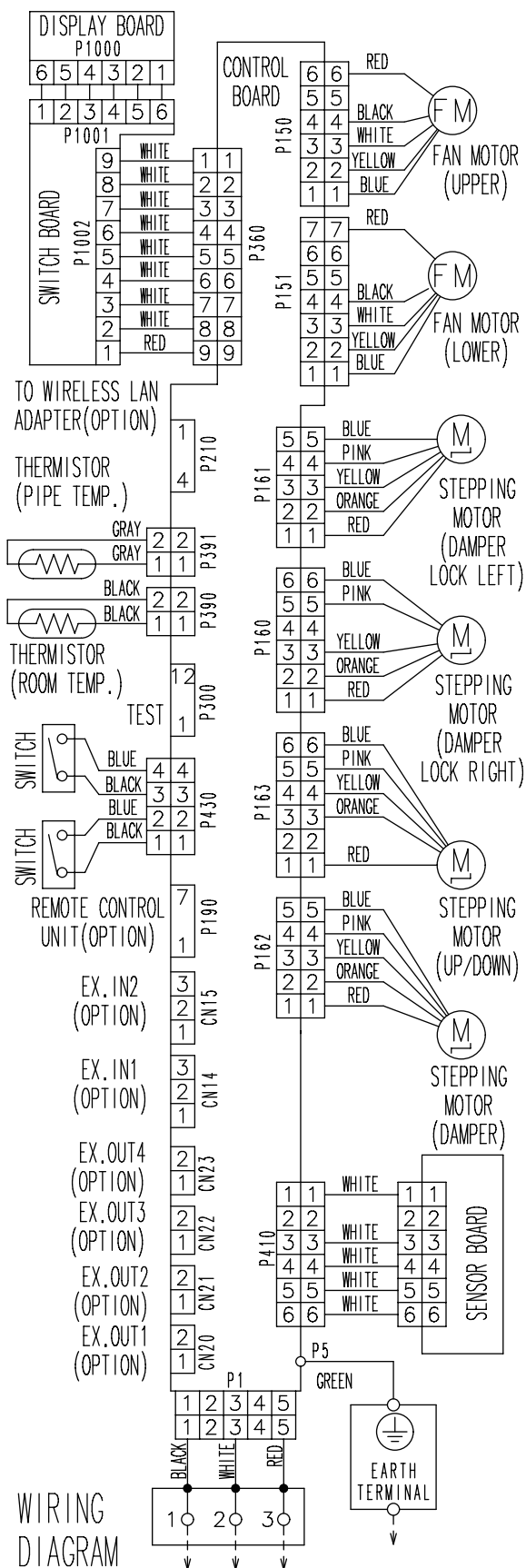

5. Air velocity and temperature distributions

5-1. Compact cassette type

■ Models: AUXG07KVLA and AUXG09KVLA

- Air velocity distribution

Measuring conditions	Fan speed	Operation mode
	HIGH	FAN

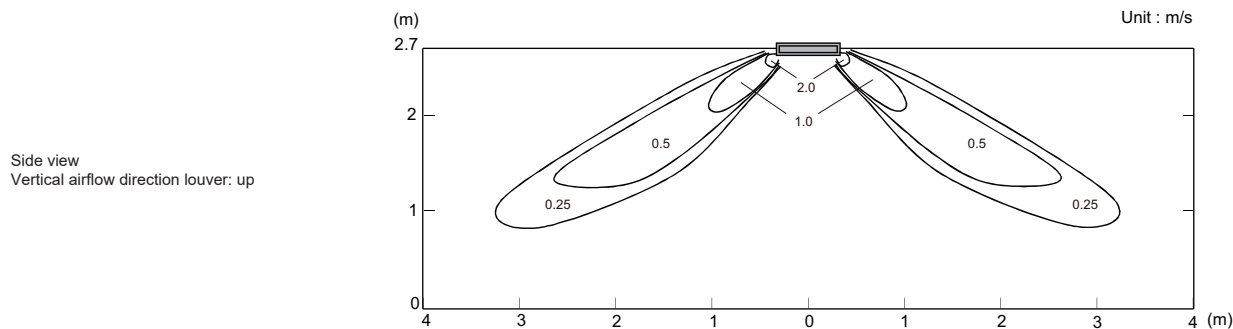
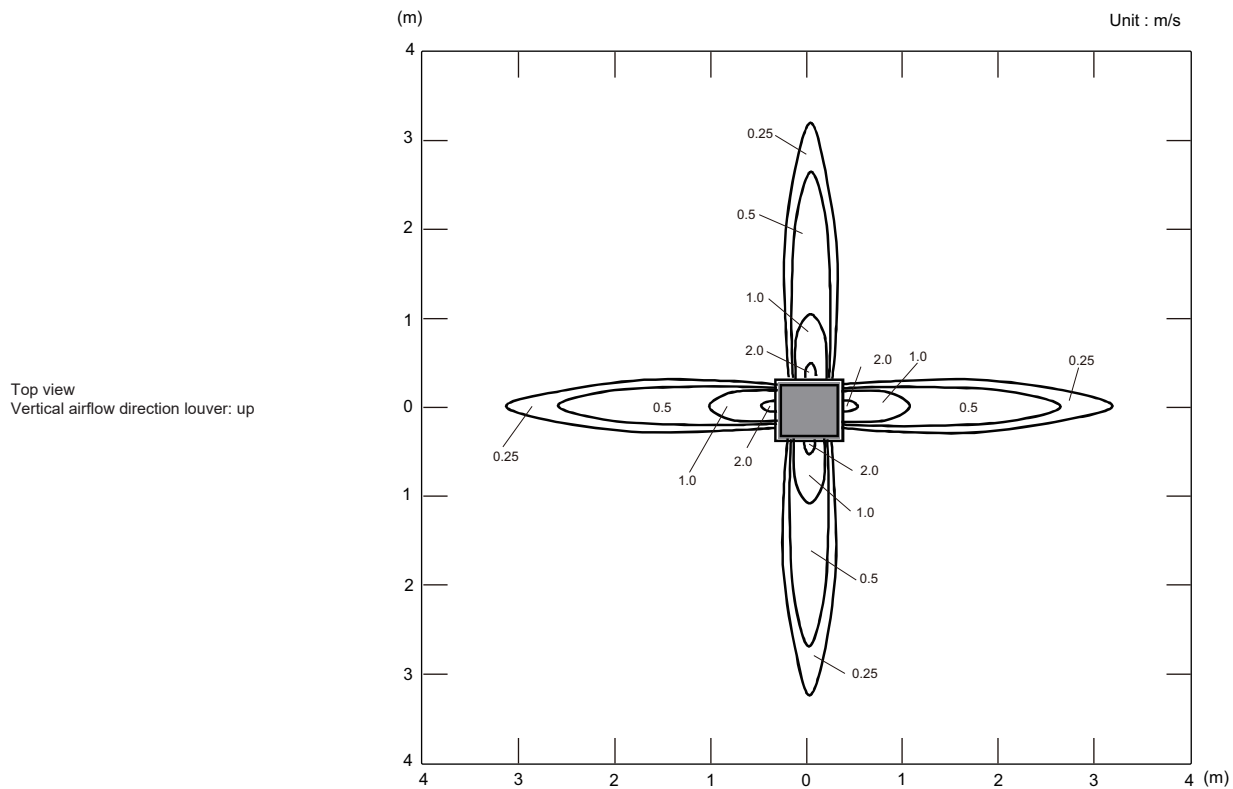

• Air velocity distribution

Measuring conditions	Fan speed	Operation mode	Outlet directions
NOTE: Reference data	HIGH	HEAT	4-way air outlet

Side view
Vertical airflow direction louver: down

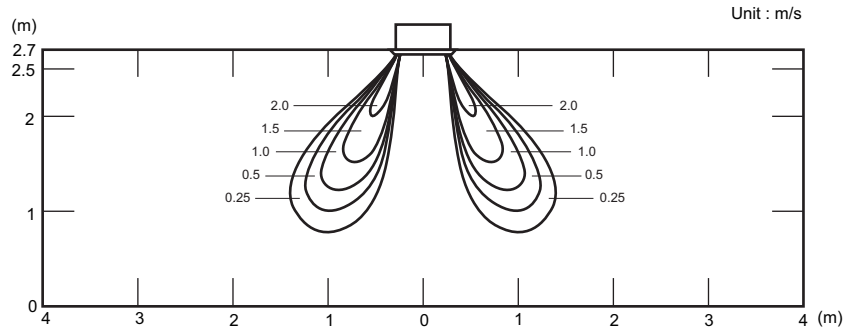

• Air temperature distribution

Measuring conditions	Fan speed	Operation mode	Outlet directions
NOTE: Reference data	HIGH	HEAT	4-way air outlet

Side view
Vertical airflow direction louver: down

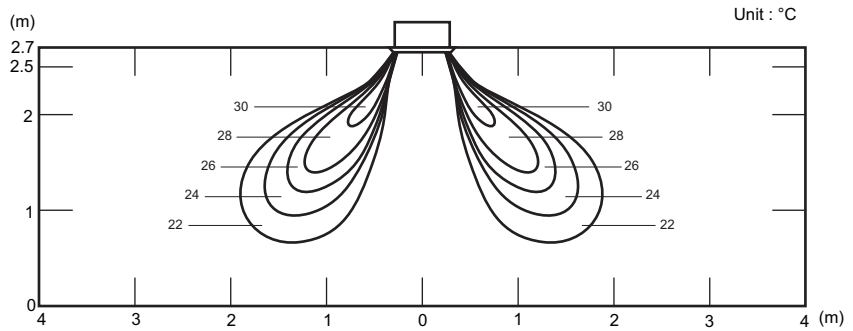

Model: AUXG12KVL A

- Air velocity distribution

Measuring conditions	Fan speed	Operation mode
	HIGH	FAN

Top view
Vertical airflow direction louver: up

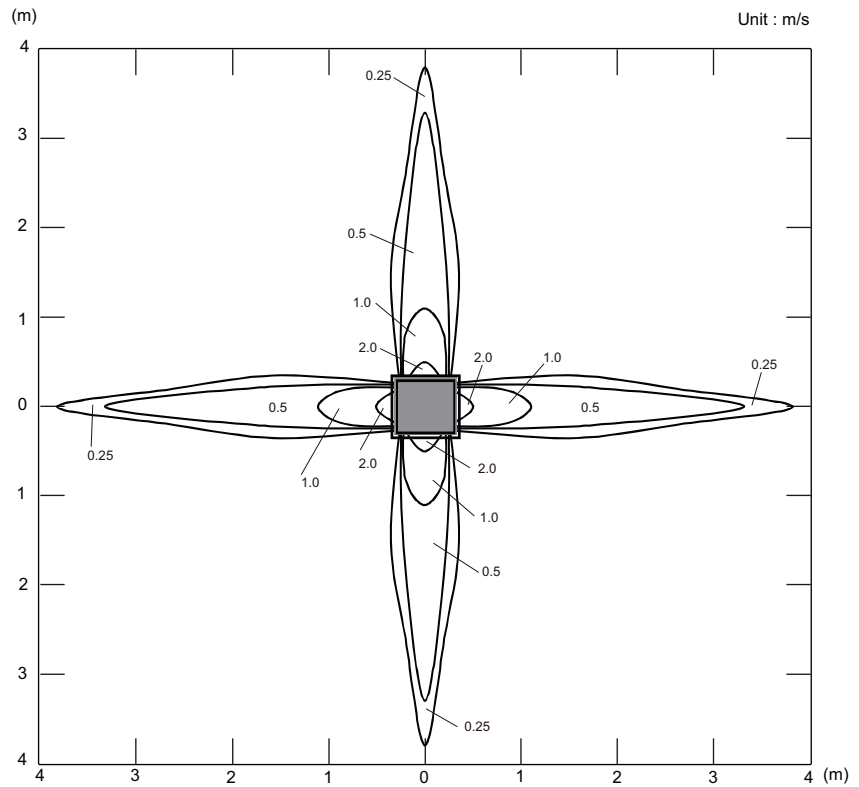

Side view
Vertical airflow direction louver: up

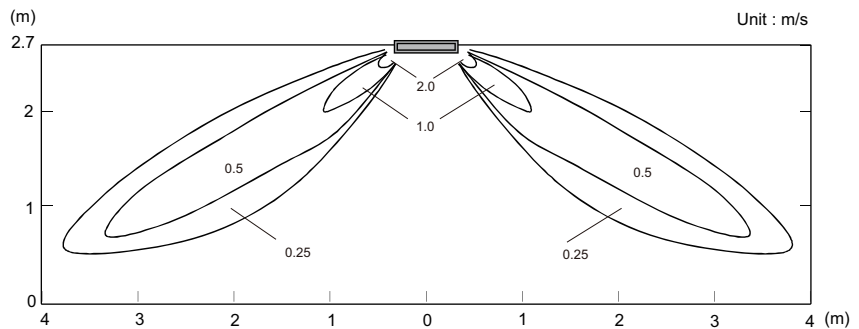

• Air velocity distribution

Measuring conditions	Fan speed	Operation mode	Outlet directions
NOTE:Reference data	HIGH	HEAT	4-way air outlet

Side view
Vertical airflow direction louver: down

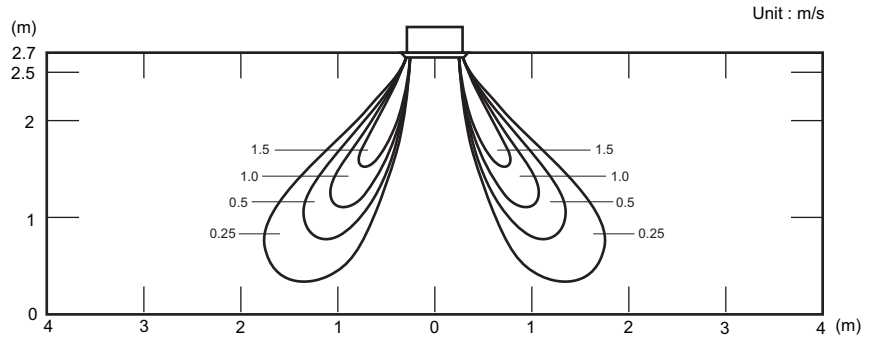

• Air temperature distribution

Measuring conditions	Fan speed	Operation mode	Outlet directions
NOTE:Reference data	HIGH	HEAT	4-way air outlet

Side view
Vertical airflow direction louver: down

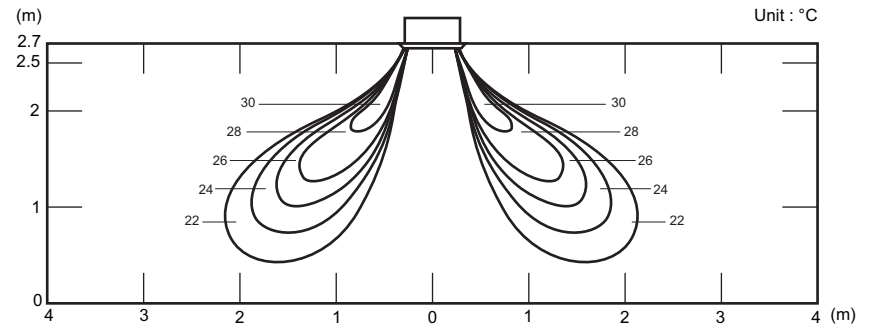

Model: AUXG14KVL A

- Air velocity distribution

Measuring conditions	Fan speed	Operation mode
	HIGH	FAN

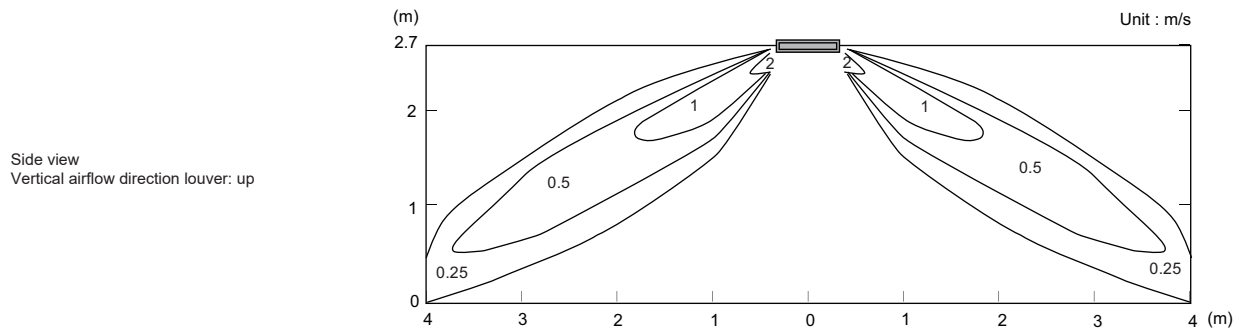
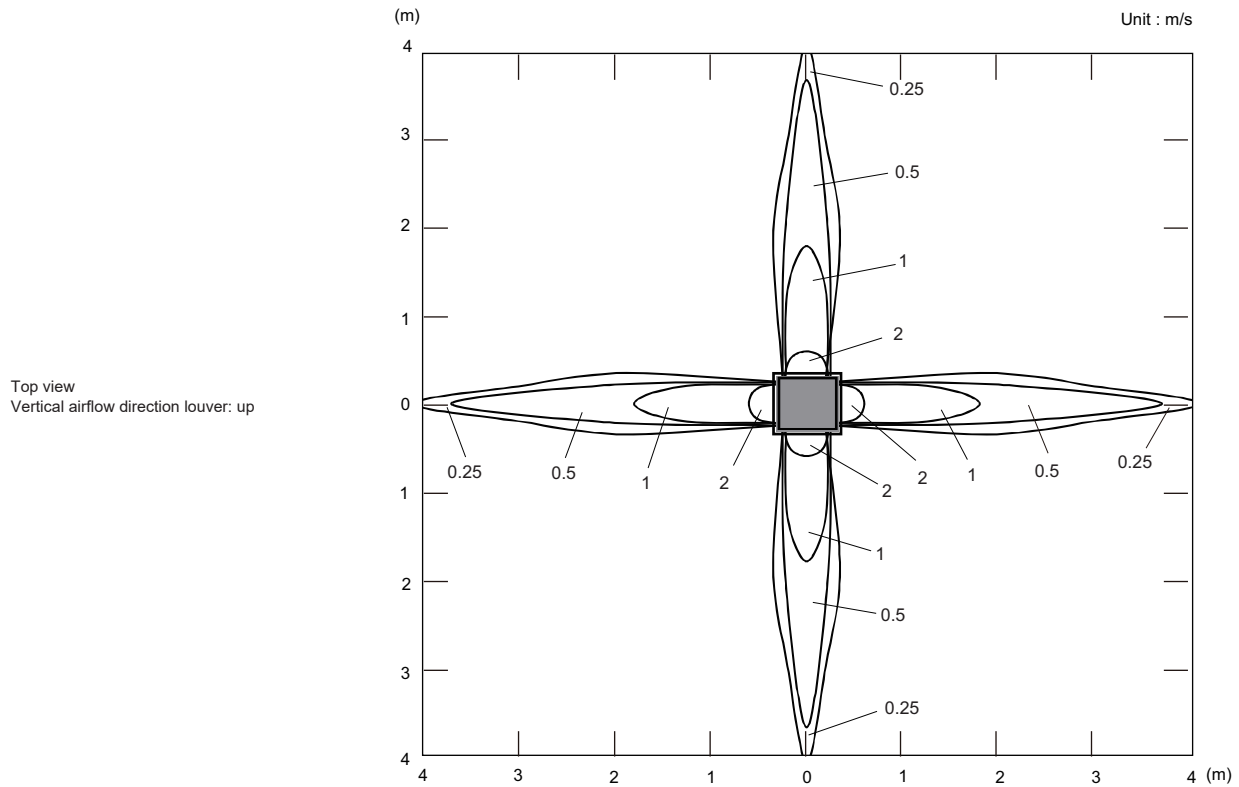

• Air velocity distribution

Measuring conditions	Fan speed	Operation mode	Outlet directions
NOTE:Reference data	HIGH	HEAT	4-way air outlet

Side view
Vertical airflow direction louver: down

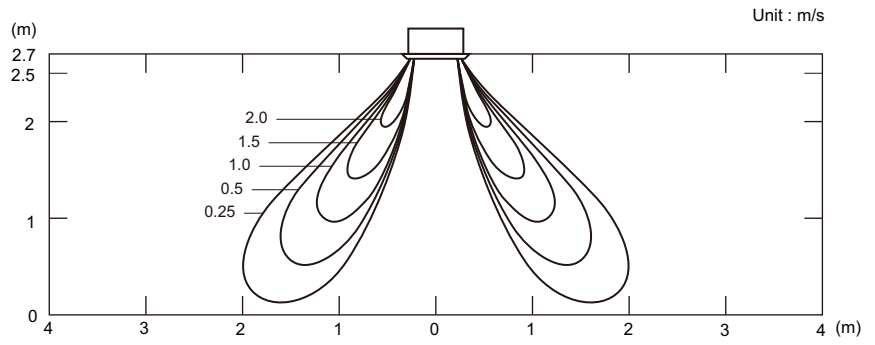

• Air temperature distribution

Measuring conditions	Fan speed	Operation mode	Outlet directions
NOTE:Reference data	HIGH	HEAT	4-way air outlet

Side view
Vertical airflow direction louver: down

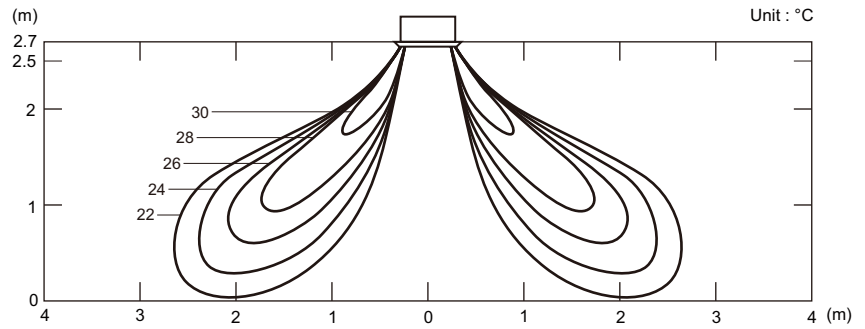

Model: AUXG18KVL A

Measuring conditions	Fan speed	Operation mode	Ceiling mode
	HIGH	FAN	STANDARD

4-5 UNIT
MULTI-SPLIT TYPE

4-5 UNIT
MULTI-SPLIT TYPE

Top view
Vertical airflow direction louver: Upward

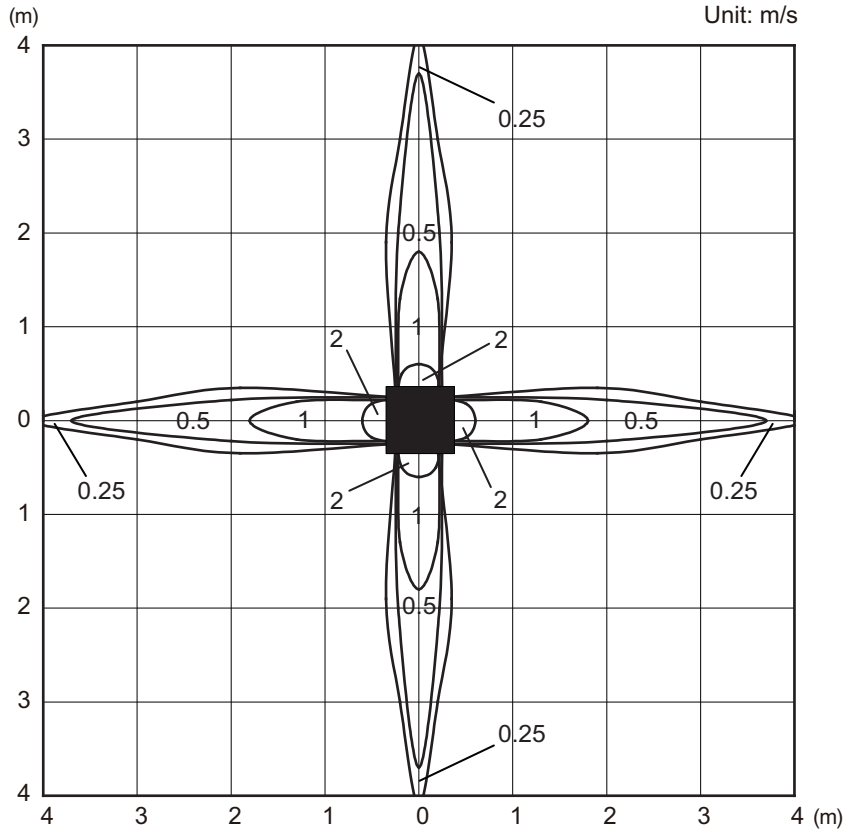

Side view
Vertical airflow direction louver: Upward

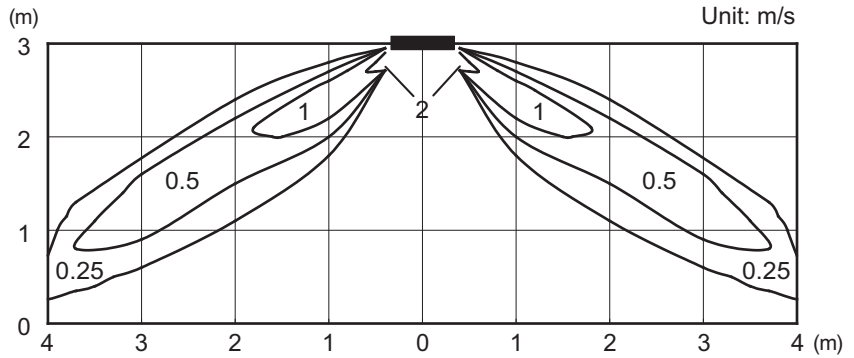

Side view
Vertical airflow direction louver: Downward

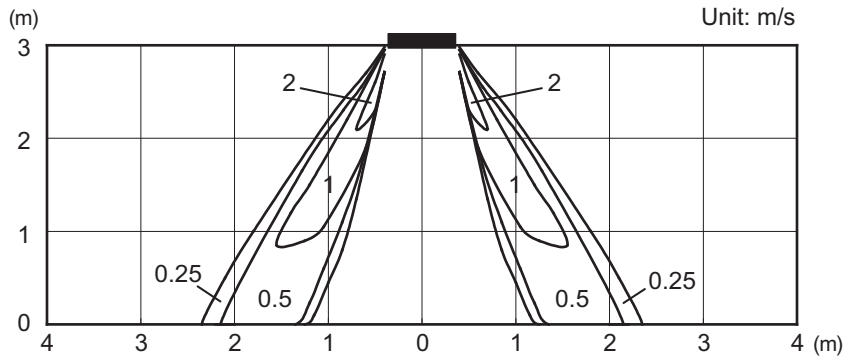

Model: AUXG22KVL A

Measuring conditions	Fan speed	Operation mode	Ceiling mode
	HIGH	FAN	STANDARD

4-5 UNIT
MULTI-SPLIT TYPE

4-5 UNIT
MULTI-SPLIT TYPE

Top view
Vertical airflow direction louver: Upward

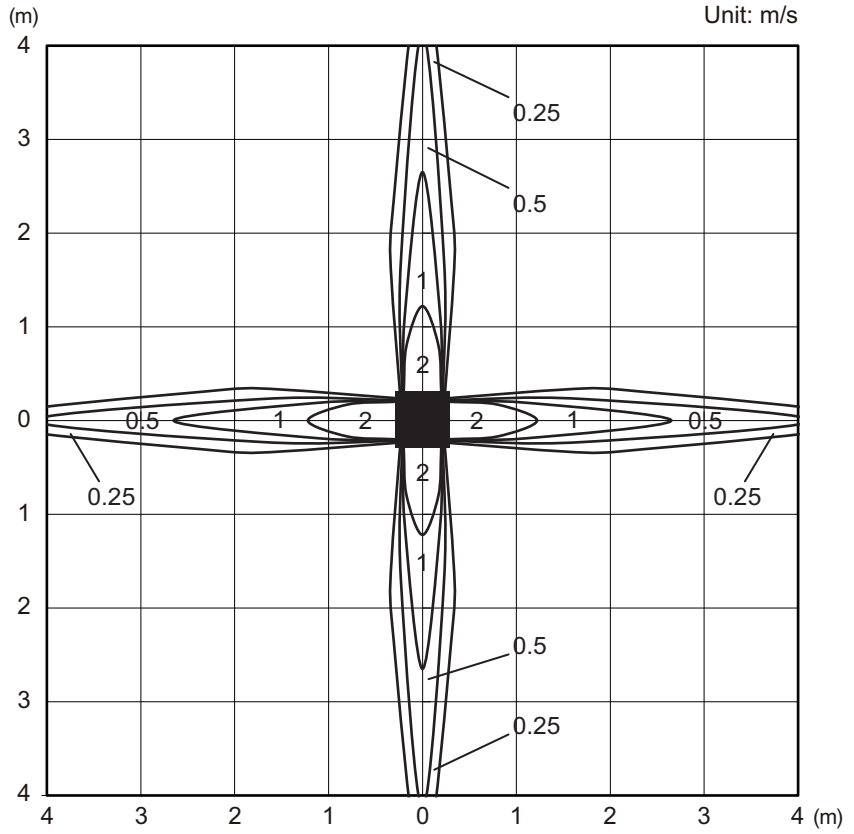

Side view
Vertical airflow direction louver: Upward

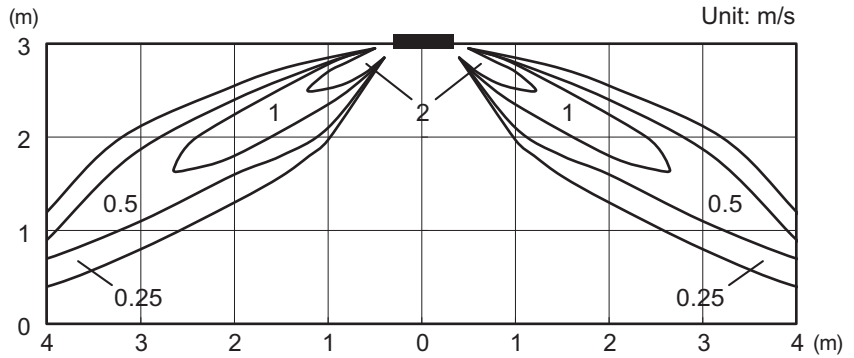

Side view
Vertical airflow direction louver: Downward

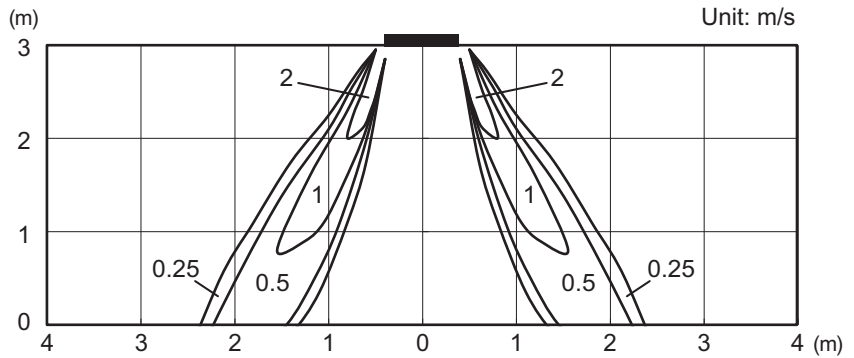

5-2. Mini duct type

Model: ARXG07KSLAP

NOTE: This data is measured after installing optional Auto louver grille kit.

- Air velocity distribution

Measuring conditions	Fan speed	Operation mode
	HIGH	FAN

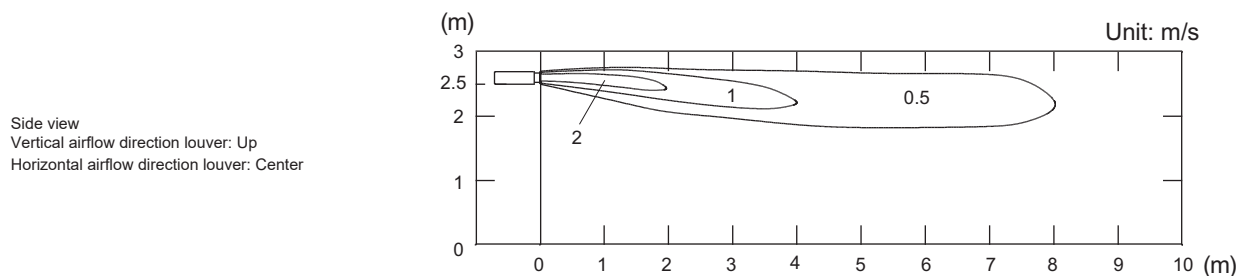
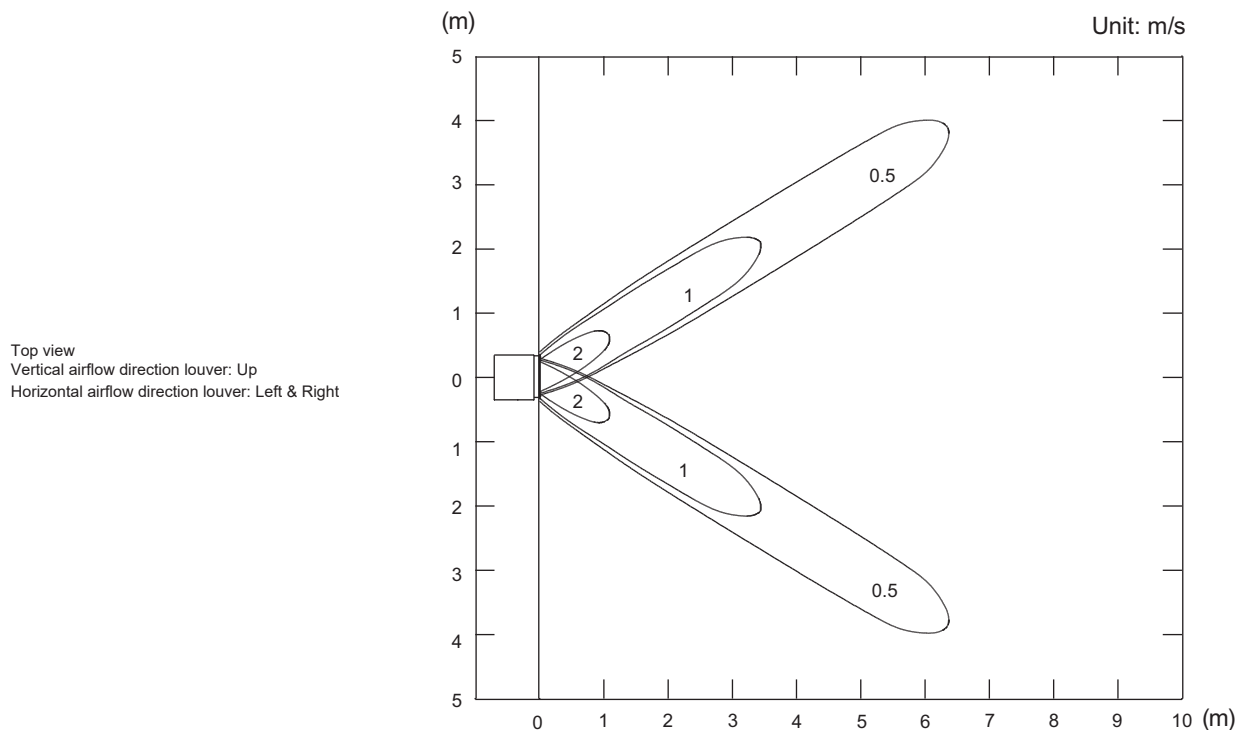
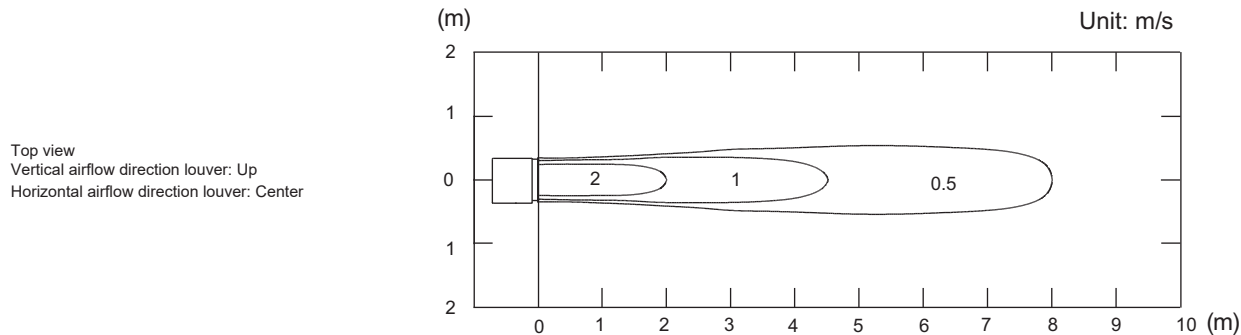

• Air velocity distribution

Measuring conditions	Fan speed	Operation mode
	HIGH	HEAT

Side view
Vertical airflow direction louver: Down
Horizontal airflow direction louver: Center

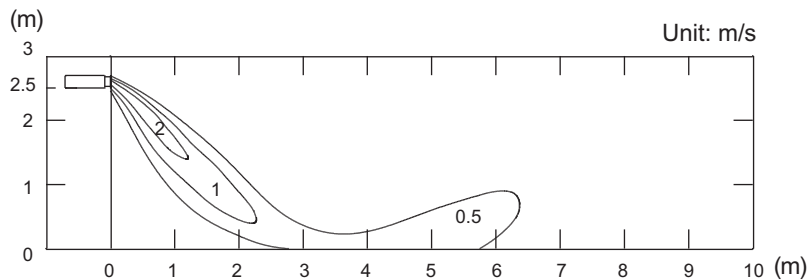

• Air temperature distribution

Measuring conditions	Fan speed	Operation mode
	HIGH	HEAT

Side view
Vertical airflow direction louver: Down
Horizontal airflow direction louver: Center

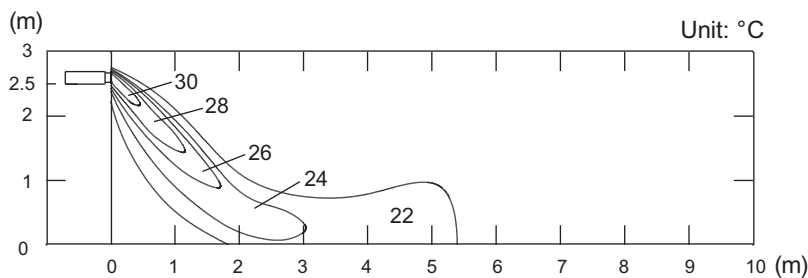

Model: ARXG09KSLAP

NOTE: This data is measured after installing optional Auto louver grille kit.

- Air velocity distribution

Measuring conditions	Fan speed	Operation mode
	HIGH	FAN

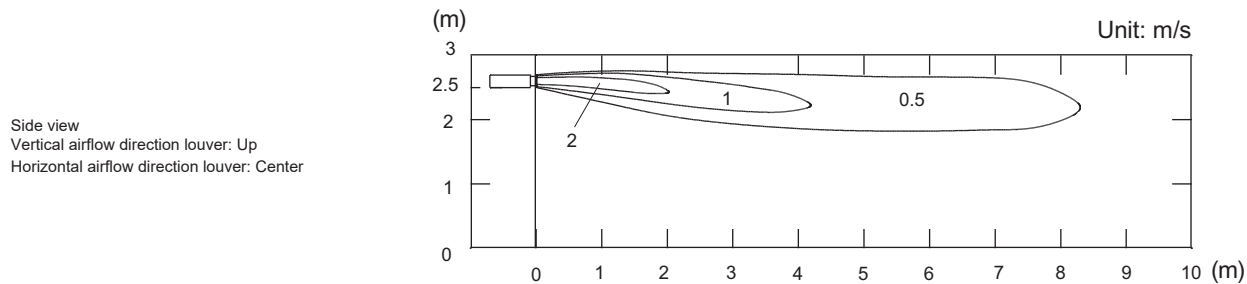
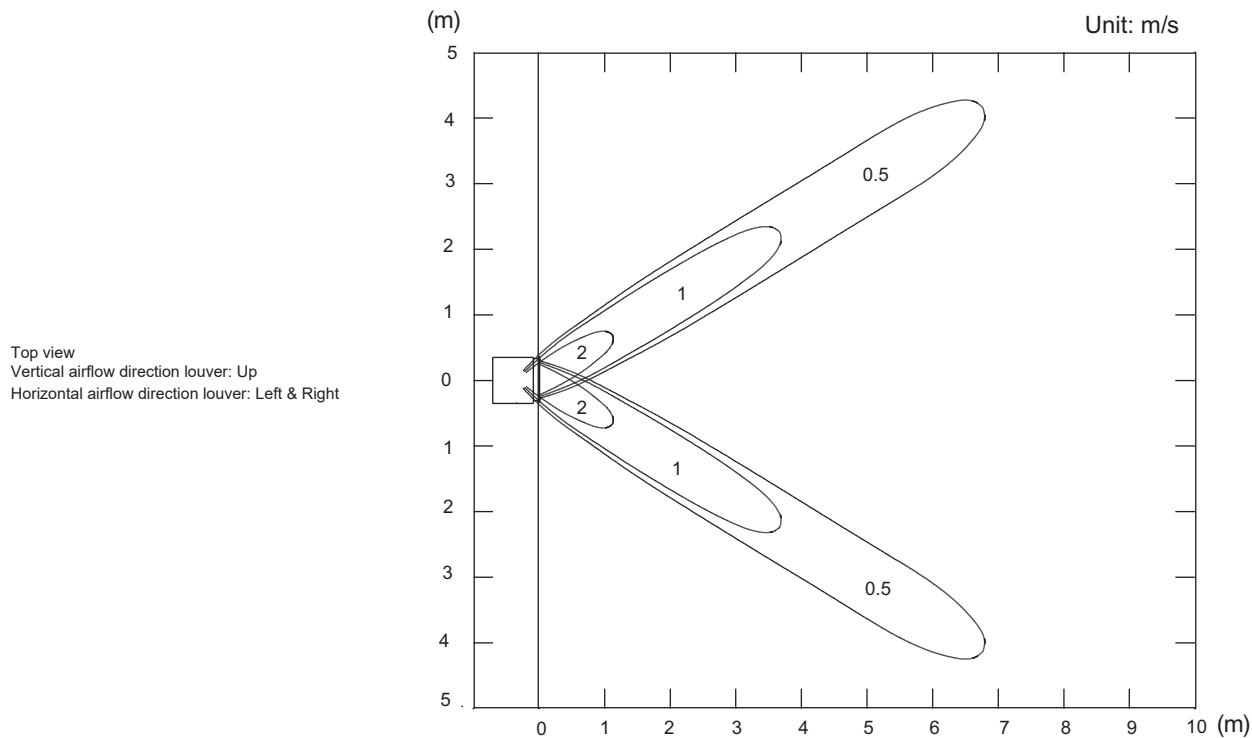
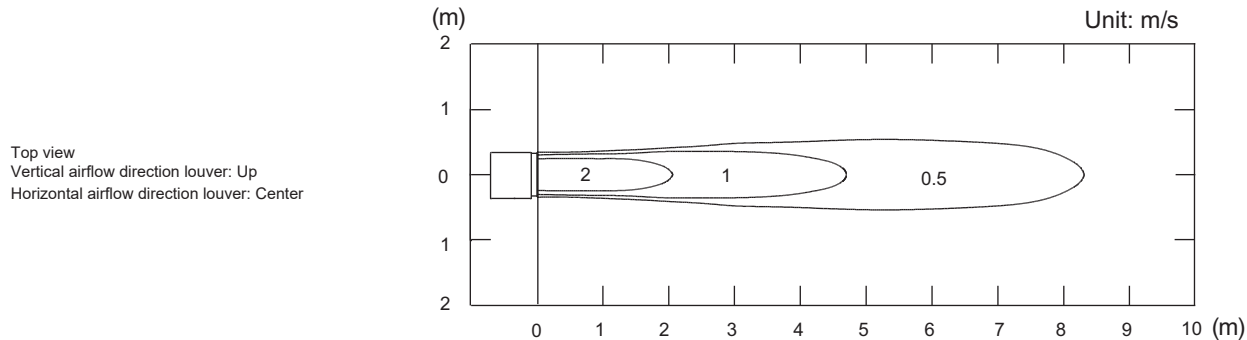

• Air velocity distribution

Measuring conditions	Fan speed	Operation mode
	HIGH	HEAT

Side view
Vertical airflow direction louver: Down
Horizontal airflow direction louver: Center

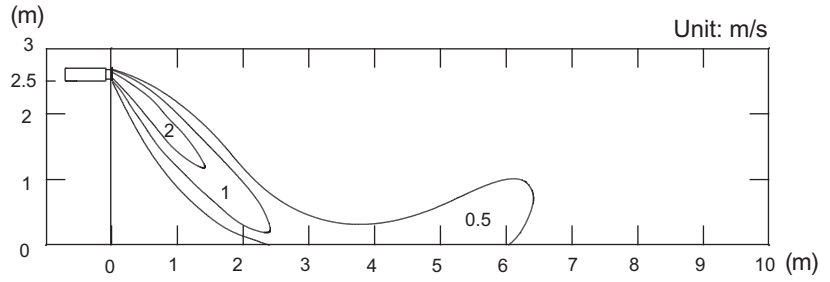

• Air temperature distribution

Measuring conditions	Fan speed	Operation mode
	HIGH	HEAT

Side view
Vertical airflow direction louver: Down
Horizontal airflow direction louver: Center

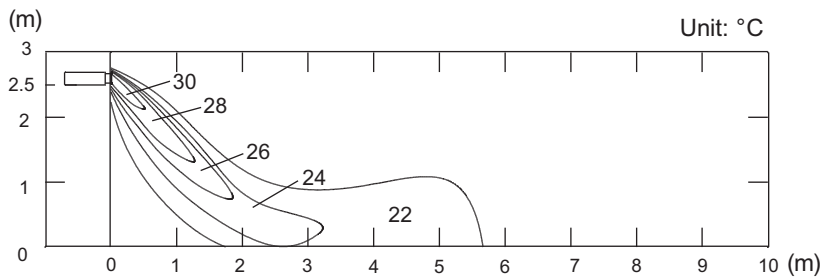

Model: ARXG12KSLAP

NOTE: This data is measured after installing optional Auto louver grille kit.

- Air velocity distribution

Measuring conditions	Fan speed	Operation mode
	HIGH	FAN

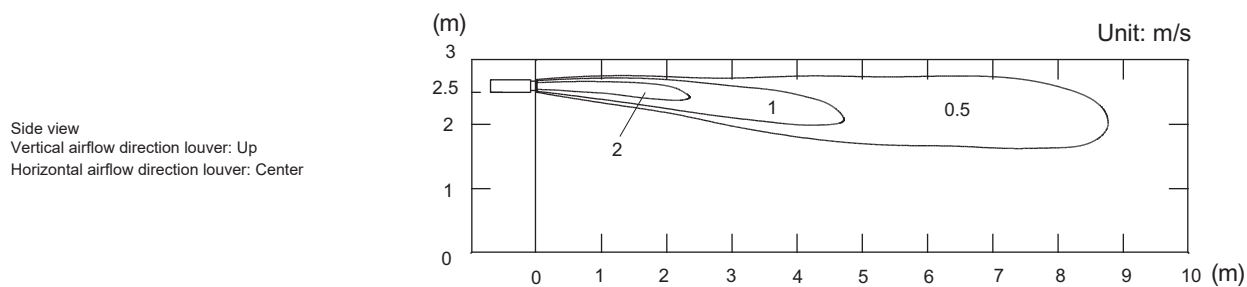
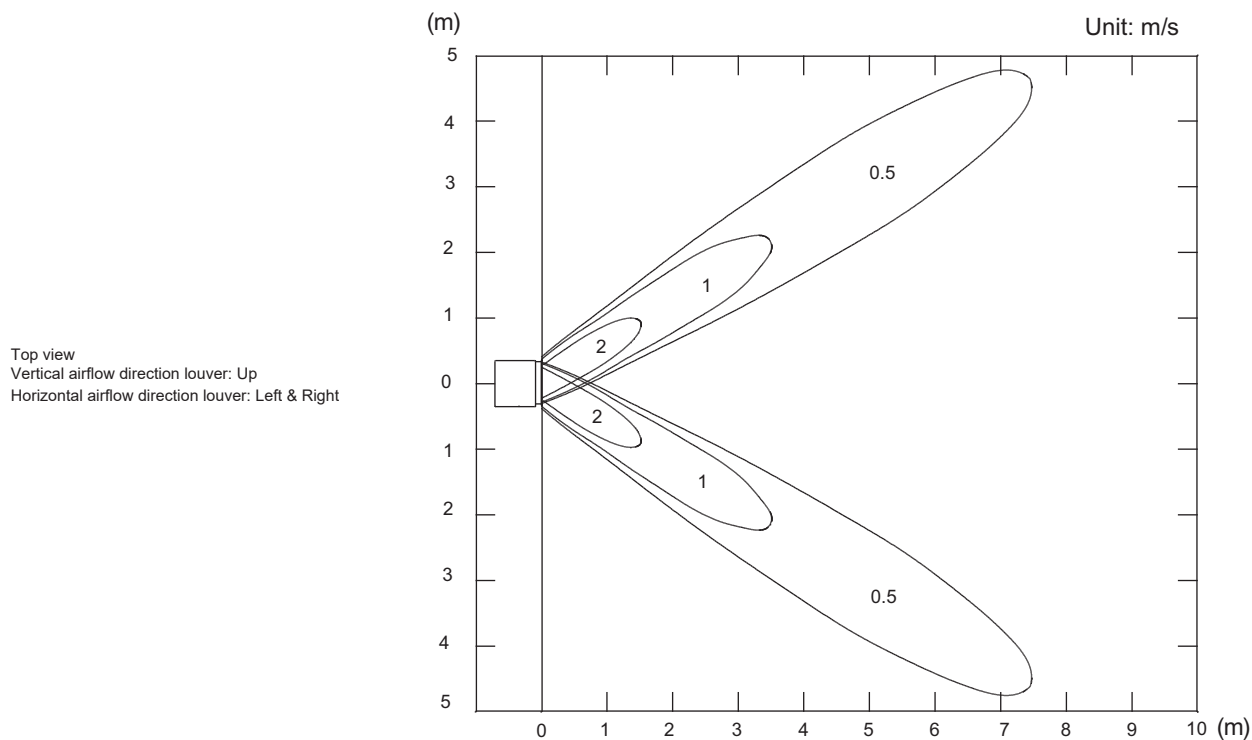
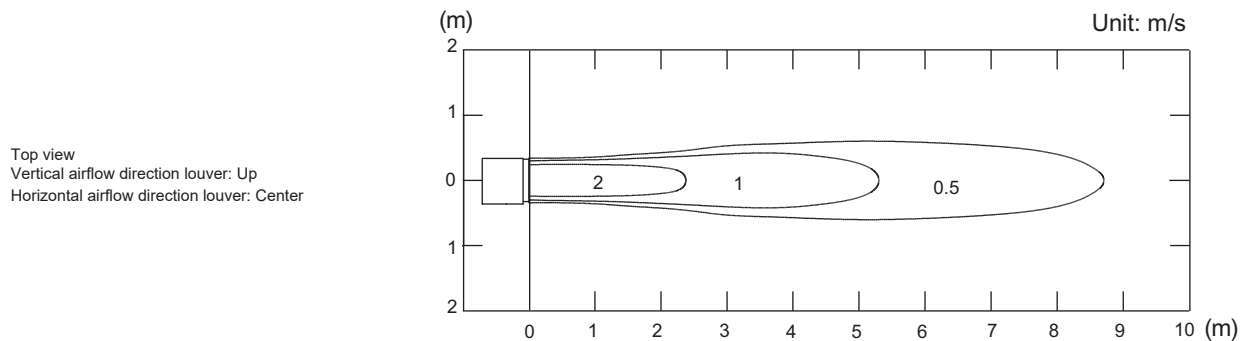

• Air velocity distribution

Measuring conditions	Fan speed	Operation mode
	HIGH	HEAT

Side view
Vertical airflow direction louver: Down
Horizontal airflow direction louver: Center

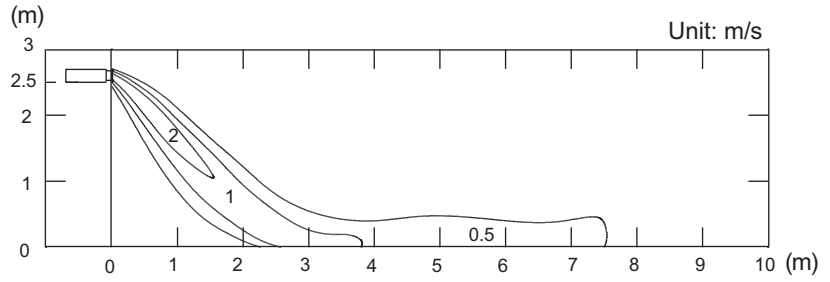

• Air temperature distribution

Measuring conditions	Fan speed	Operation mode
	HIGH	HEAT

Side view
Vertical airflow direction louver: Down
Horizontal airflow direction louver: Center

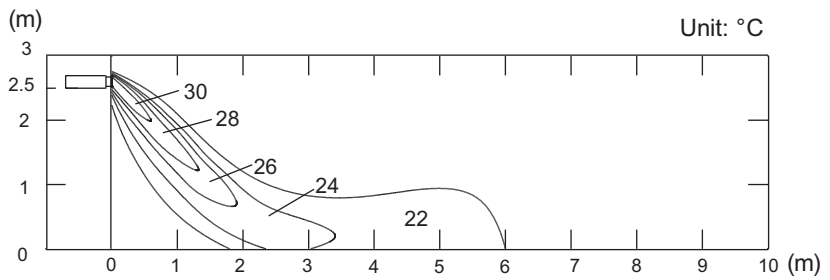

Model: ARXG14KSLAP

NOTE: This data is measured after installing optional Auto louver grille kit.

- Air velocity distribution

Measuring conditions	Fan speed	Operation mode
	HIGH	FAN

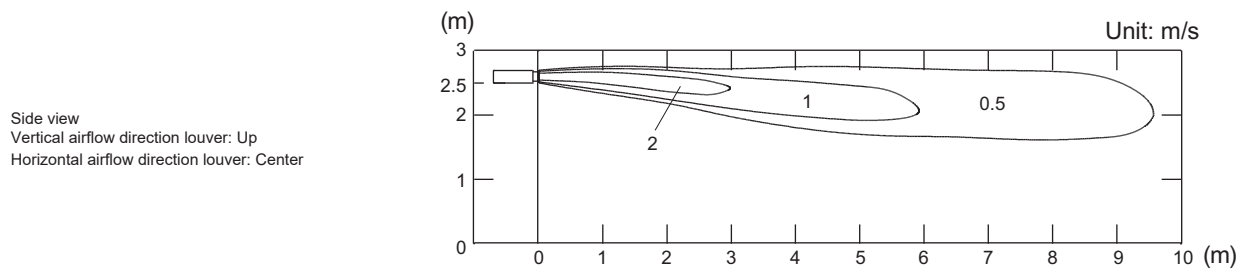
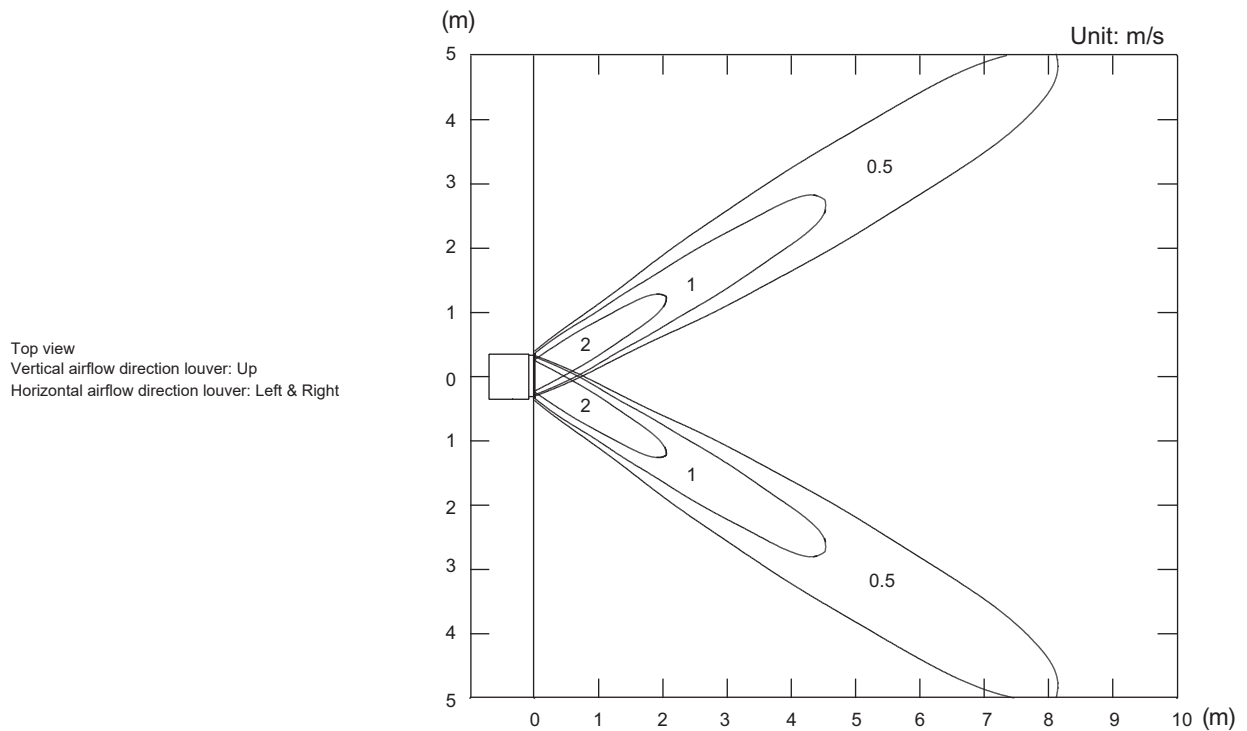
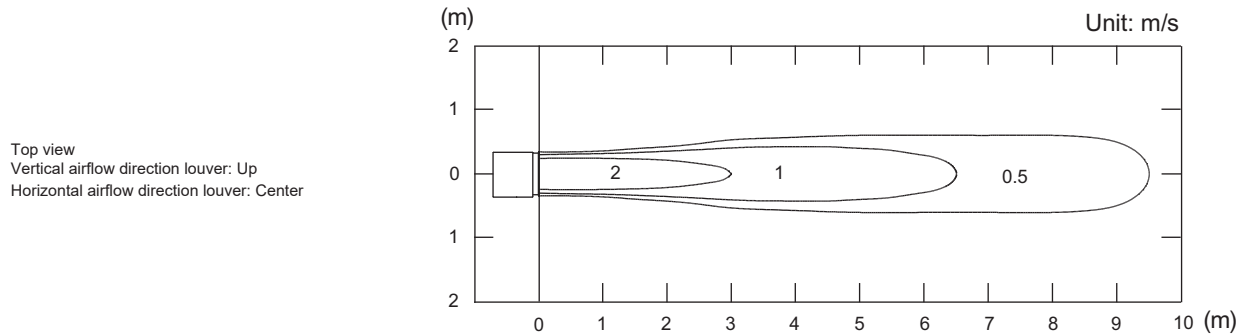

• Air velocity distribution

Measuring conditions	Fan speed	Operation mode
	HIGH	HEAT

Side view
Vertical airflow direction louver: Down
Horizontal airflow direction louver: Center

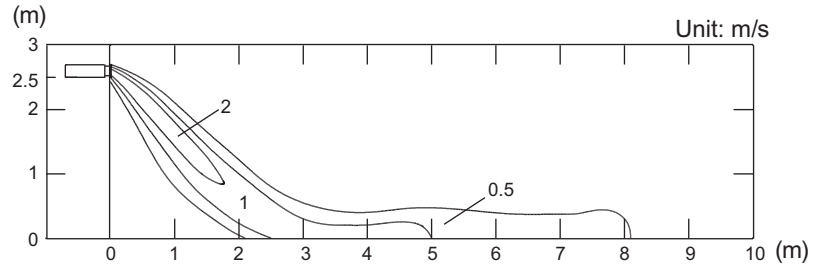

• Air temperature distribution

Measuring conditions	Fan speed	Operation mode
	HIGH	HEAT

Side view
Vertical airflow direction louver: Down
Horizontal airflow direction louver: Center

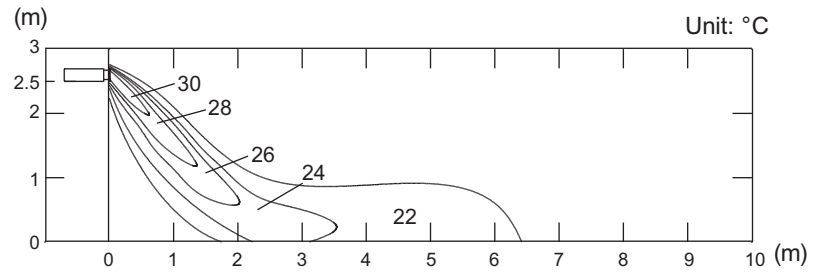

Model: ARXG18KSLAP

NOTE: This data is measured after installing optional Auto louver grille kit.

- Air velocity distribution

Measuring conditions	Fan speed	Operation mode
	HIGH	FAN

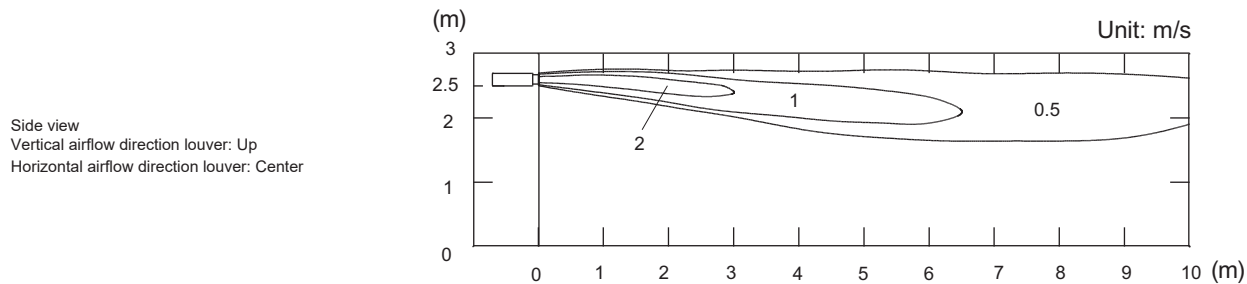
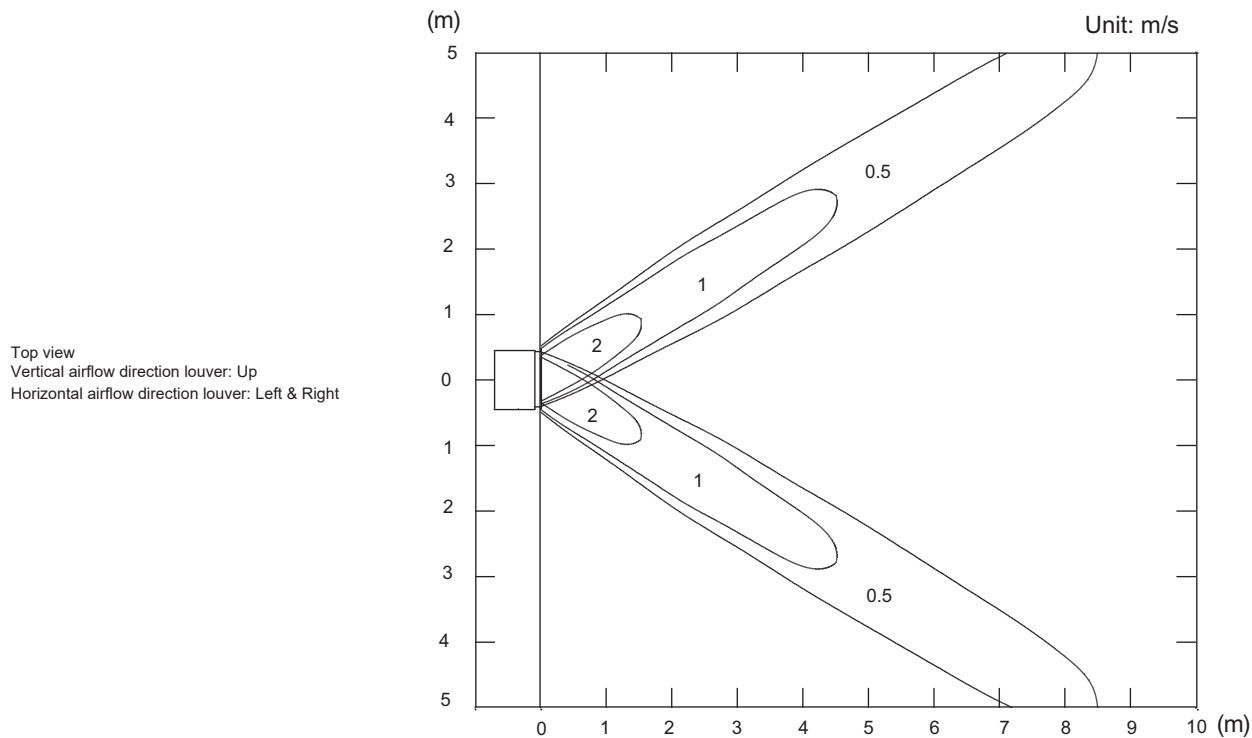
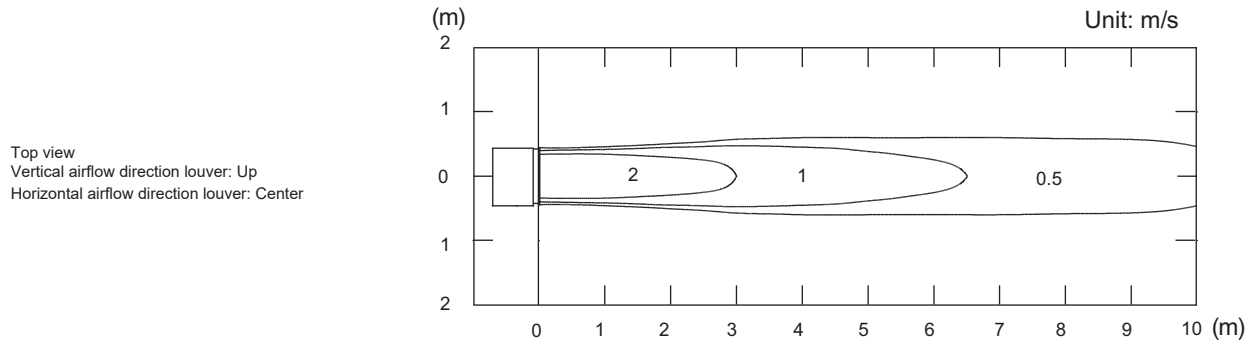

• Air velocity distribution

Measuring conditions	Fan speed	Operation mode
	HIGH	HEAT

Side view
Vertical airflow direction louver: Down
Horizontal airflow direction louver: Center

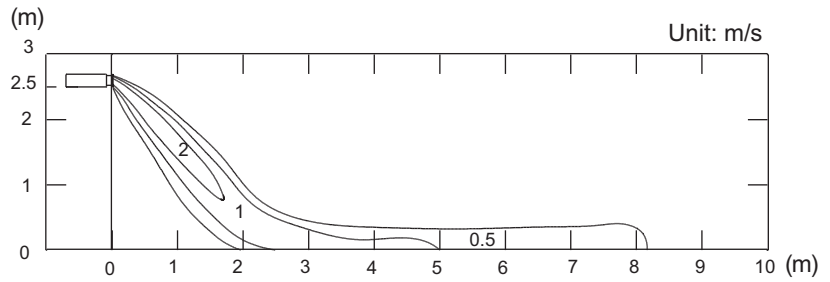

• Air temperature distribution

Measuring conditions	Fan speed	Operation mode
	HIGH	HEAT

Side view
Vertical airflow direction louver: Down
Horizontal airflow direction louver: Center

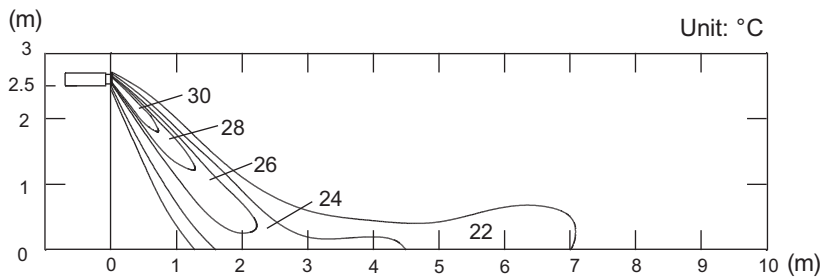

5-3. Slim duct type

Model: ARXG07KLLAP

NOTE: This data is measured after installing optional Auto louver grille kit.

- Air velocity distribution

Measuring conditions	Fan speed	Operation mode
	HIGH	FAN

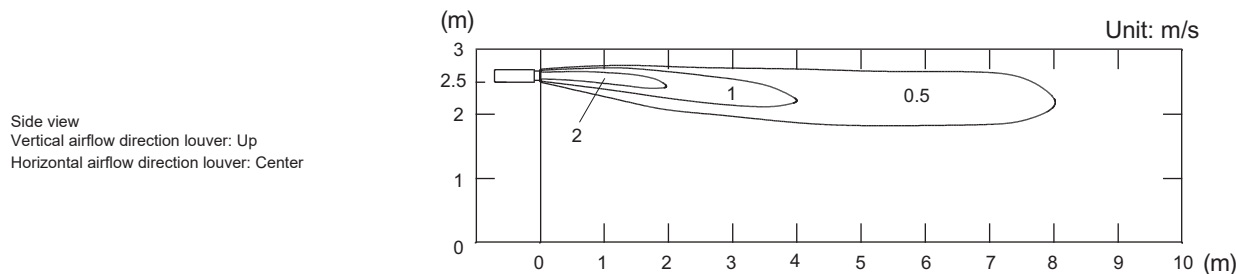
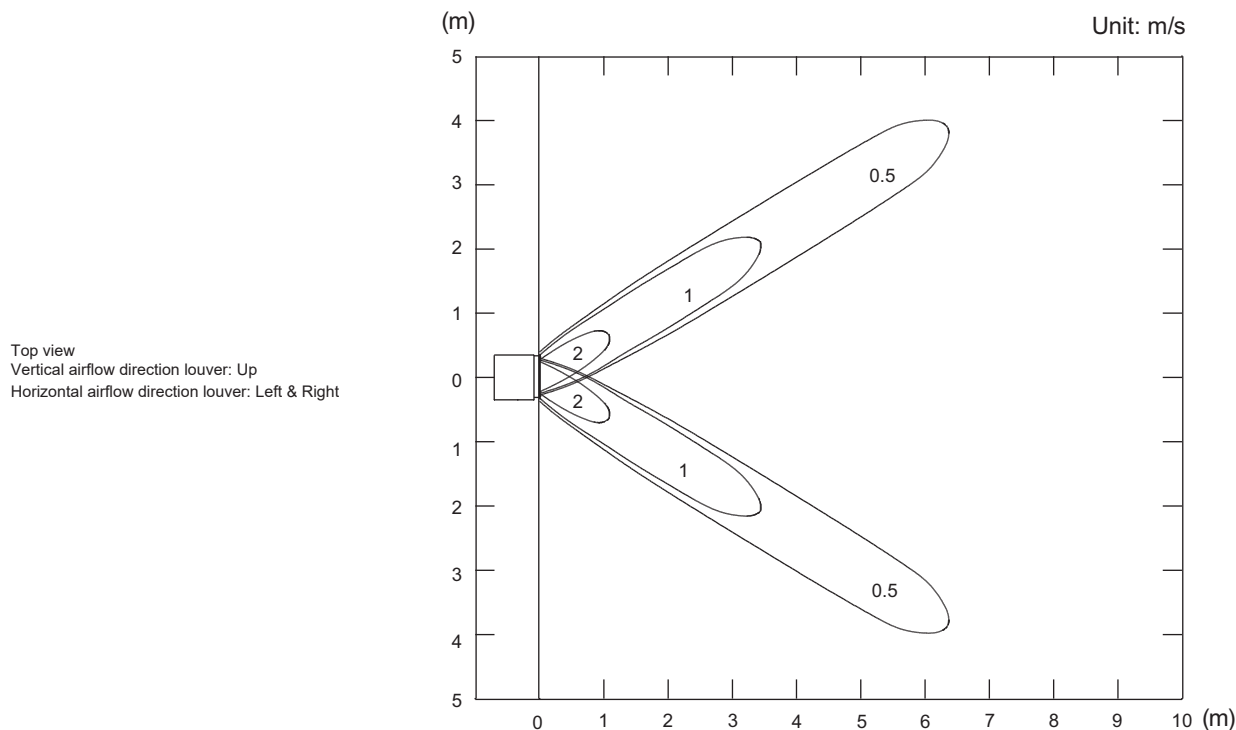
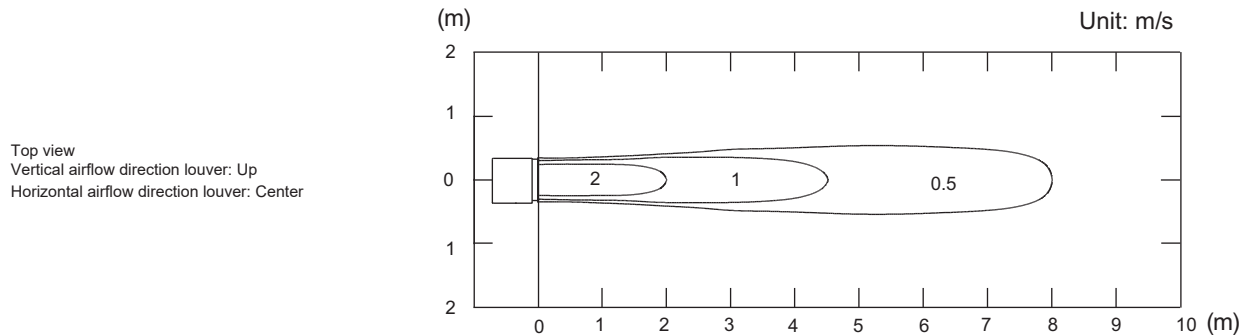

• Air velocity distribution

Measuring conditions	Fan speed	Operation mode
	HIGH	HEAT

Side view
Vertical airflow direction louver: Down
Horizontal airflow direction louver: Center

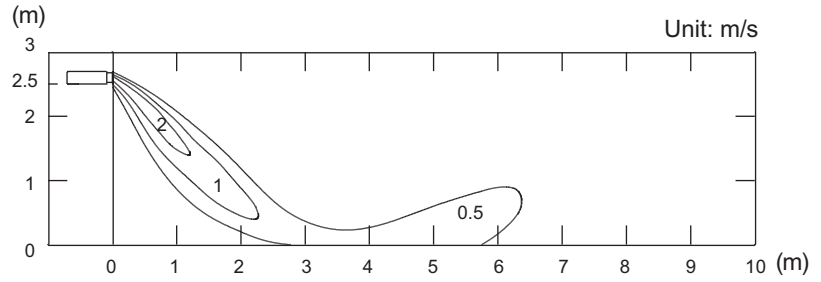

• Air temperature distribution

Measuring conditions	Fan speed	Operation mode
	HIGH	HEAT

Side view
Vertical airflow direction louver: Down
Horizontal airflow direction louver: Center

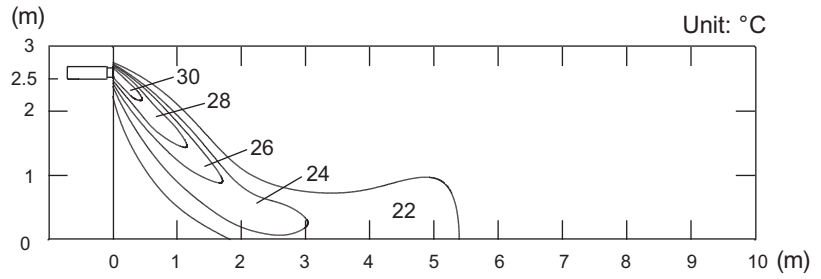

Model: ARXG09KLLAP

NOTE: This data is measured after installing optional Auto louver grille kit.

- Air velocity distribution

Measuring conditions	Fan speed	Operation mode
	HIGH	FAN

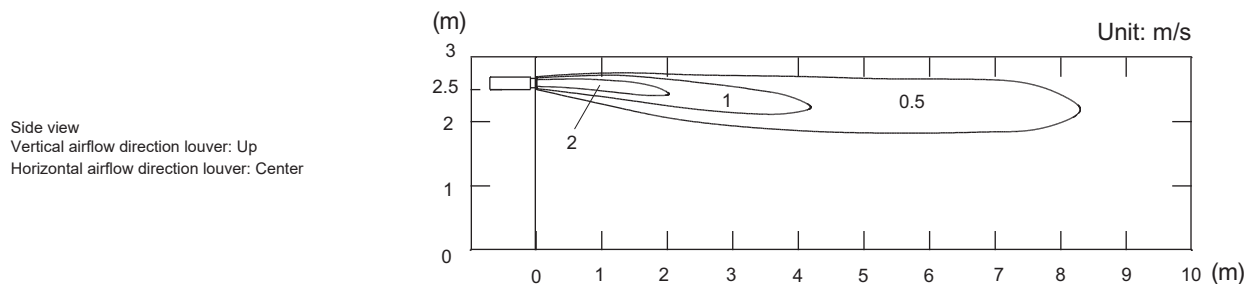
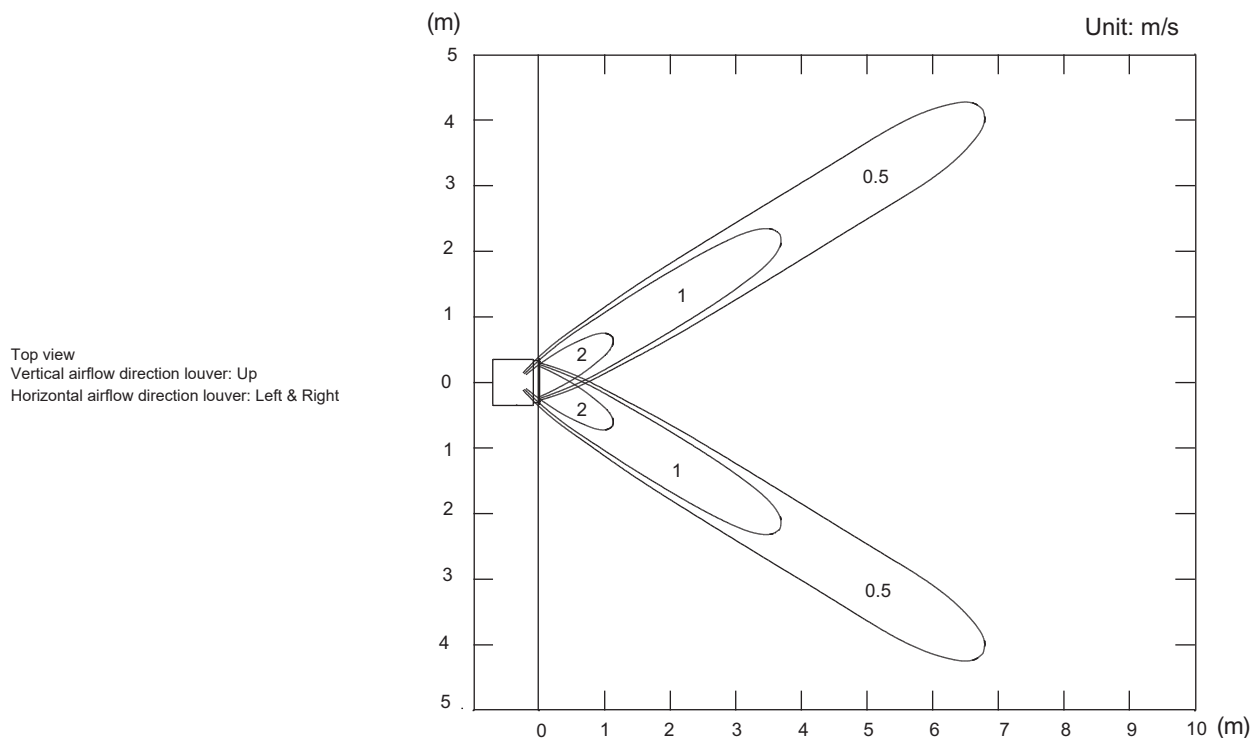
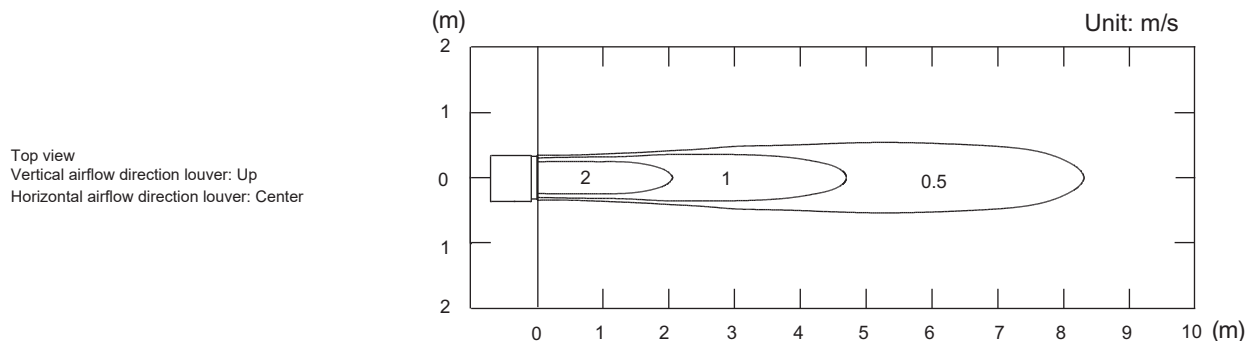

• Air velocity distribution

Measuring conditions	Fan speed	Operation mode
	HIGH	HEAT

Side view
Vertical airflow direction louver: Down
Horizontal airflow direction louver: Center

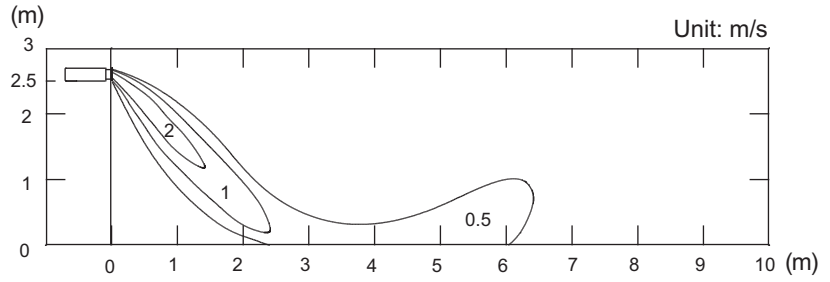

• Air temperature distribution

Measuring conditions	Fan speed	Operation mode
	HIGH	HEAT

Side view
Vertical airflow direction louver: Down
Horizontal airflow direction louver: Center

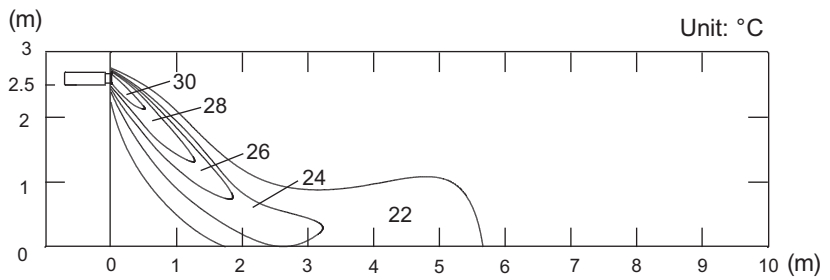

Model: ARXG12KLLAP

NOTE: This data is measured after installing optional Auto louver grille kit.

- Air velocity distribution

Measuring conditions	Fan speed	Operation mode
	HIGH	FAN

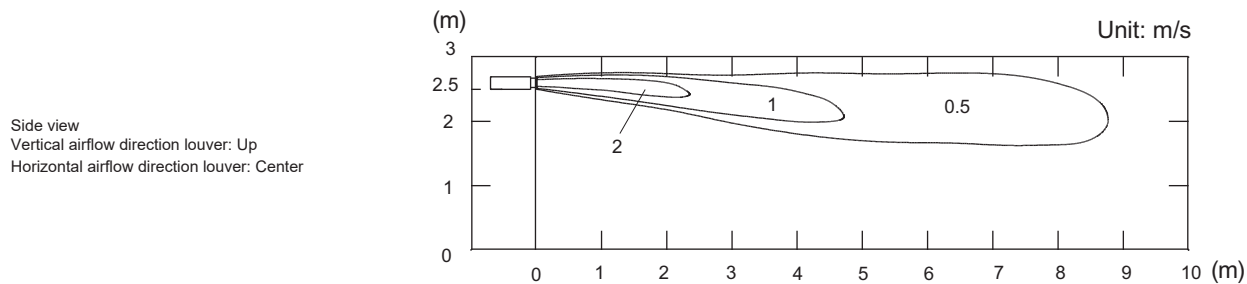
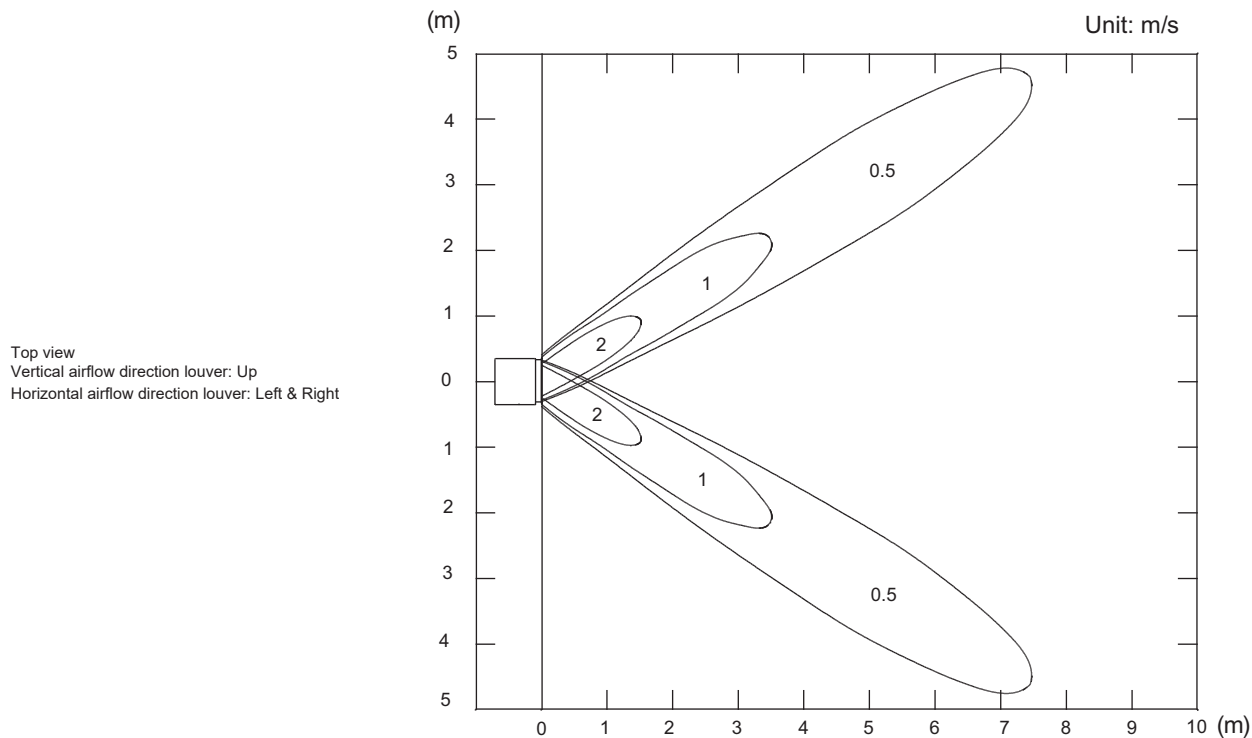
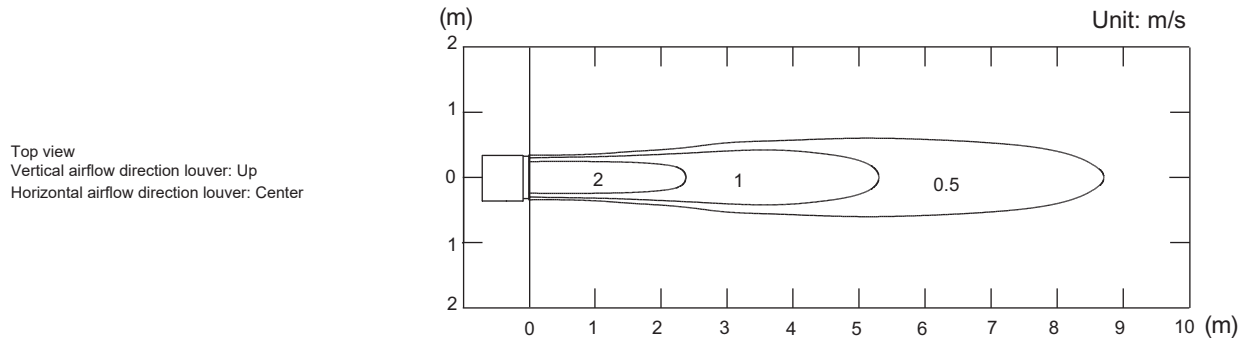

• Air velocity distribution

Measuring conditions	Fan speed	Operation mode
	HIGH	HEAT

Side view
Vertical airflow direction louver: Down
Horizontal airflow direction louver: Center

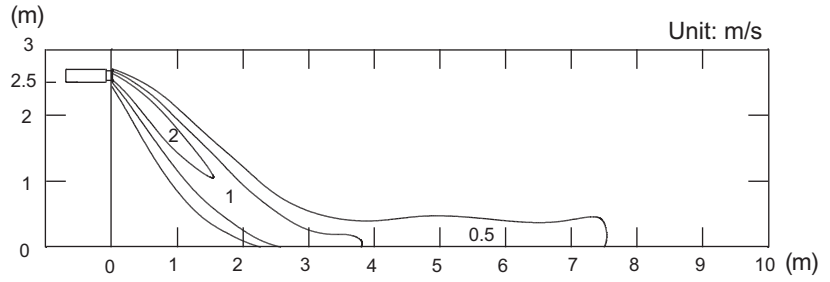

• Air temperature distribution

Measuring conditions	Fan speed	Operation mode
	HIGH	HEAT

Side view
Vertical airflow direction louver: Down
Horizontal airflow direction louver: Center

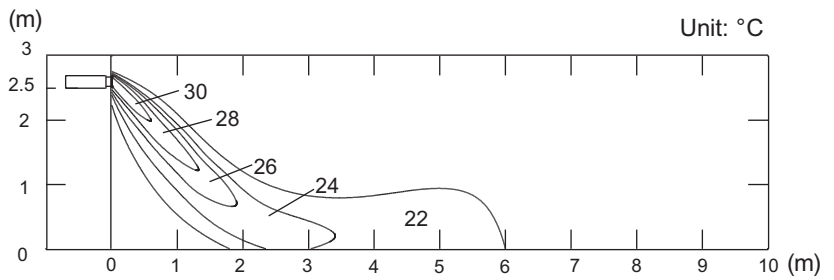

Model: ARXG14KLLAP

NOTE: This data is measured after installing optional Auto louver grille kit.

- Air velocity distribution

Measuring conditions	Fan speed	Operation mode
	HIGH	FAN

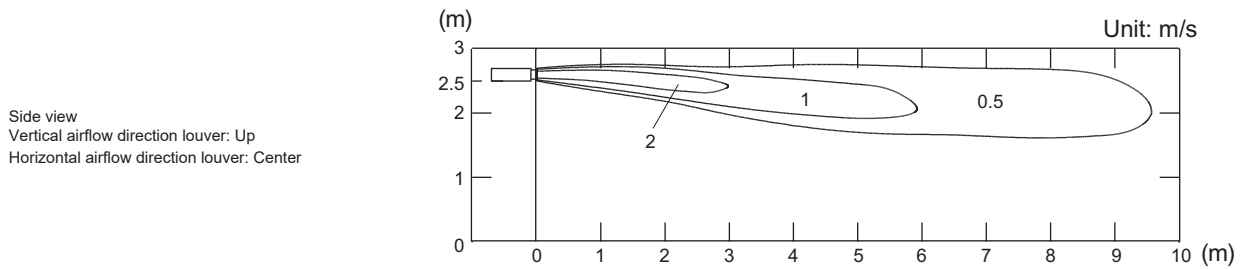
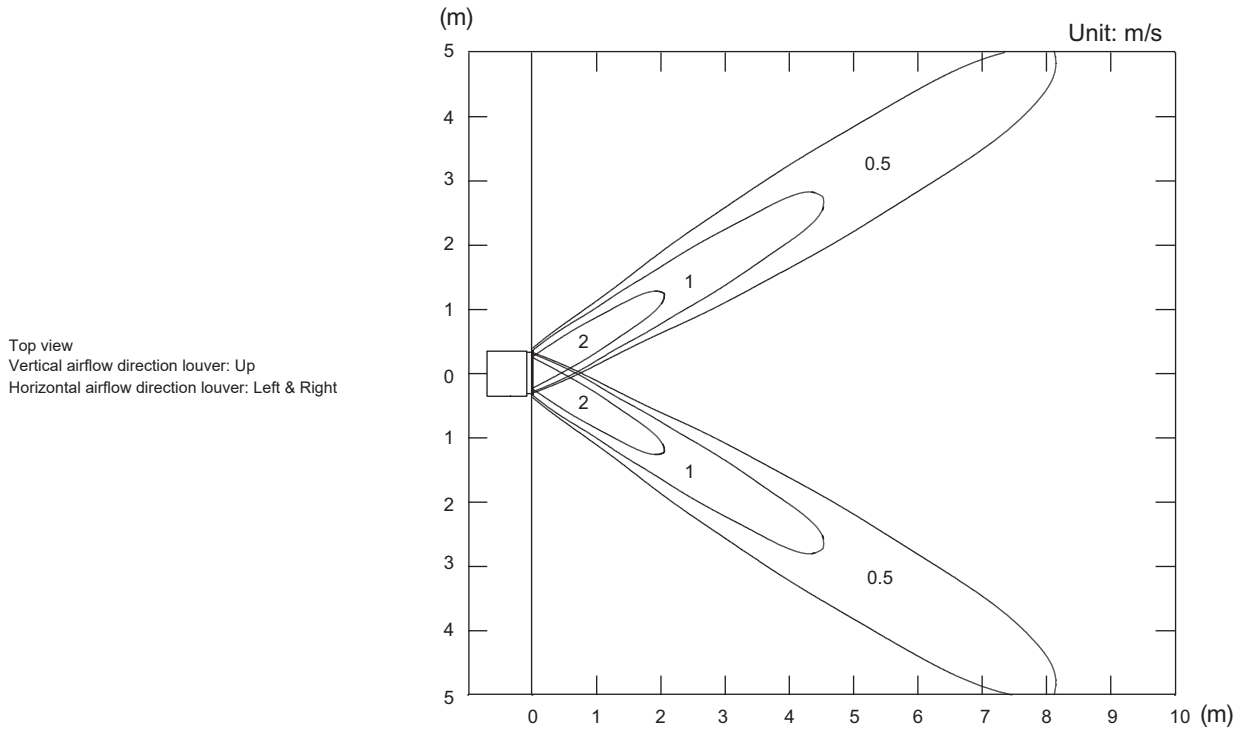
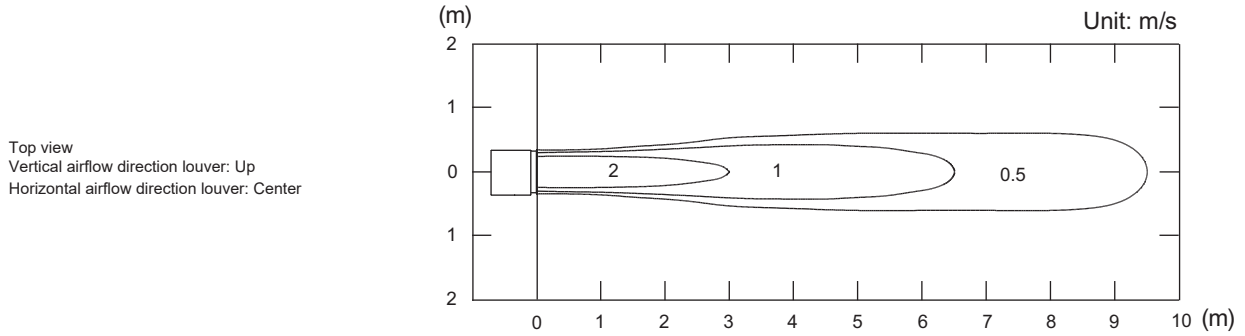

• Air velocity distribution

Measuring conditions	Fan speed	Operation mode
	HIGH	HEAT

Side view
Vertical airflow direction louver: Down
Horizontal airflow direction louver: Center

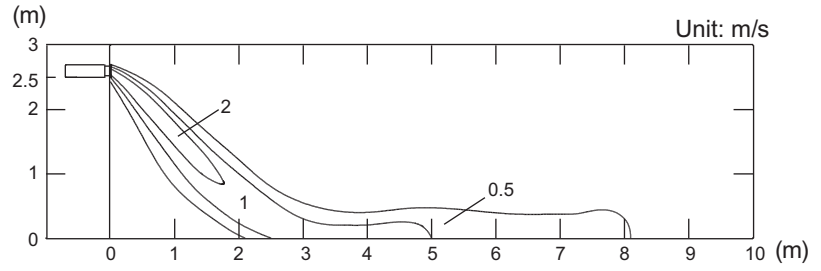

• Air temperature distribution

Measuring conditions	Fan speed	Operation mode
	HIGH	HEAT

Side view
Vertical airflow direction louver: Down
Horizontal airflow direction louver: Center

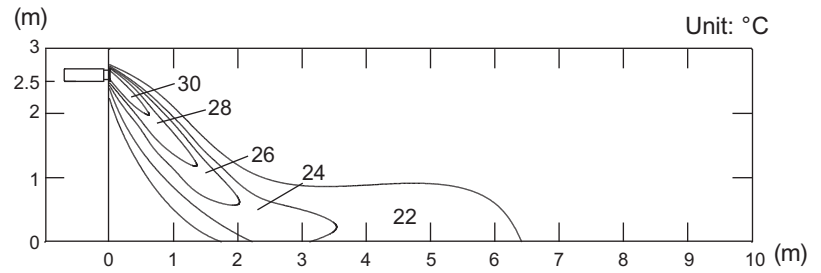

Model: ARXG18KLLAP

NOTE: This data is measured installing the Auto louver grille kit (option).

Measuring conditions	Fan speed	Operation mode
	HIGH	FAN

- Air velocity distribution

Top view
Vertical airflow direction louver: Up
Horizontal airflow direction louver: Center

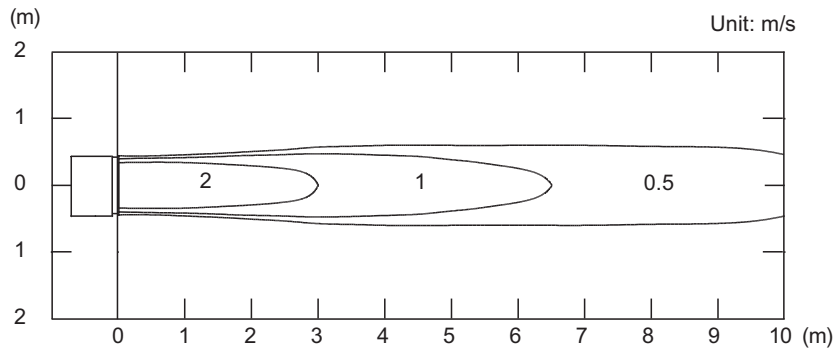

Top view
Vertical airflow direction louver: Up
Horizontal airflow direction louver: Left & Right

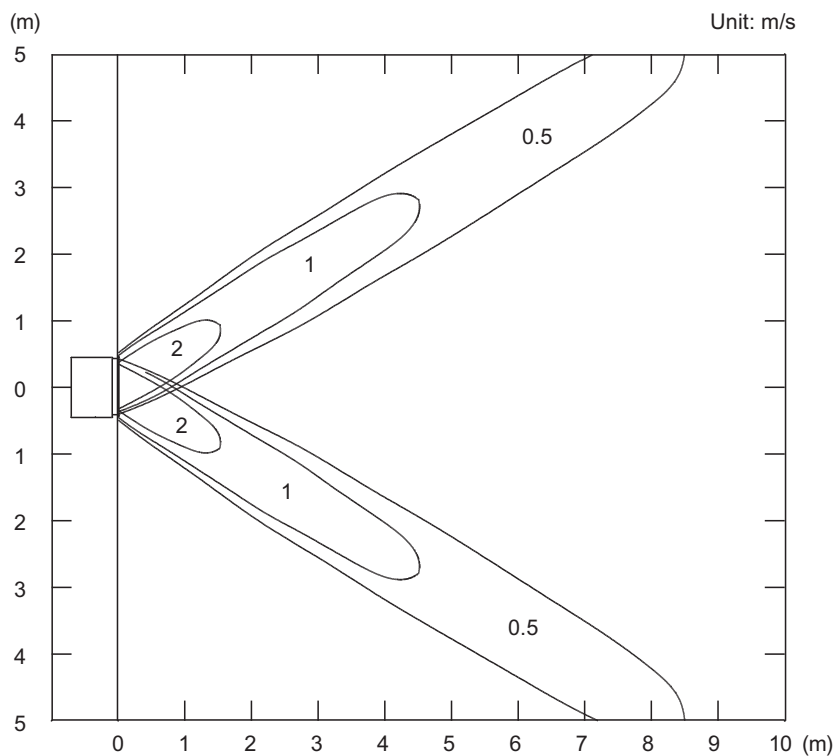

Side view
Vertical airflow direction louver: Up
Horizontal airflow direction louver: Center

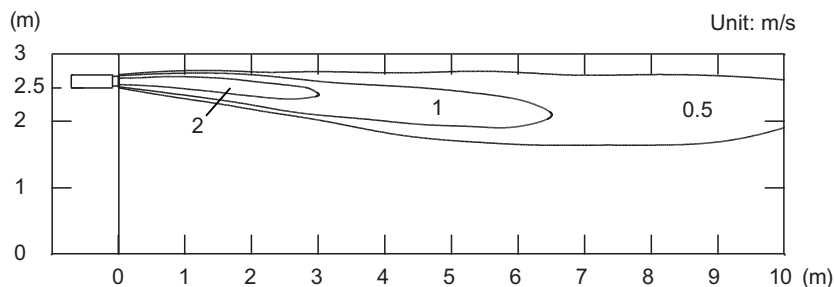

Measuring conditions	Fan speed	Operation mode
	HIGH	HEAT

• Air velocity distribution

Side view
Vertical airflow direction louver: Down
Horizontal airflow direction louver: Center

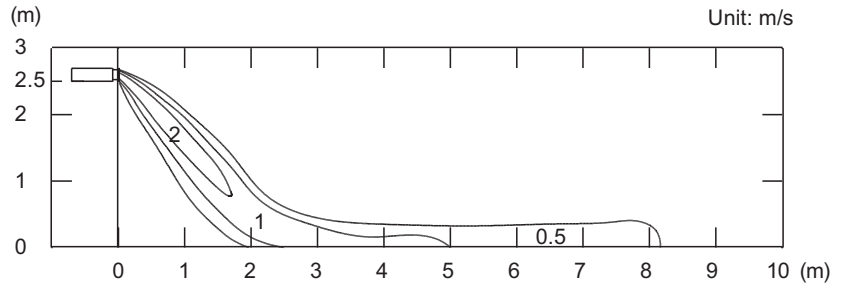

• Air temperature distribution

Side view
Vertical airflow direction louver: Down
Horizontal airflow direction louver: Center

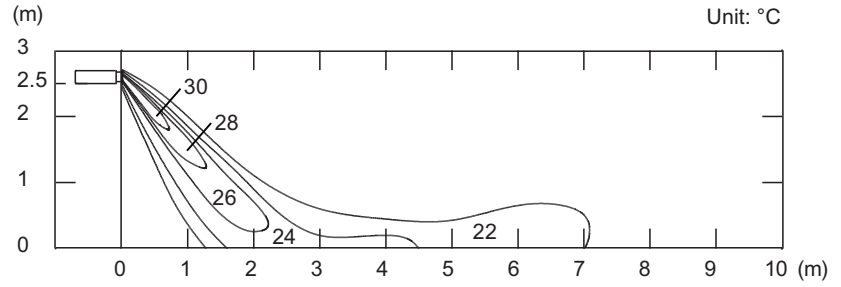

5-4. Wall mounted type

■ **Models: ASYG07KGTB, ASYG09KGTB, ASYG07KMTB, ASYG09KMTB, ASYG12KMTB, ASYG07KMCC, ASYG09KMCC, ASYG12KMCC, ASYG07KETA, ASYG09KETA, ASYG12KETA, ASYG07KETA-B, ASYG09KETA-B, and ASYG12KETA-B**

Measuring conditions	Fan speed	Operation mode
	HIGH	FAN

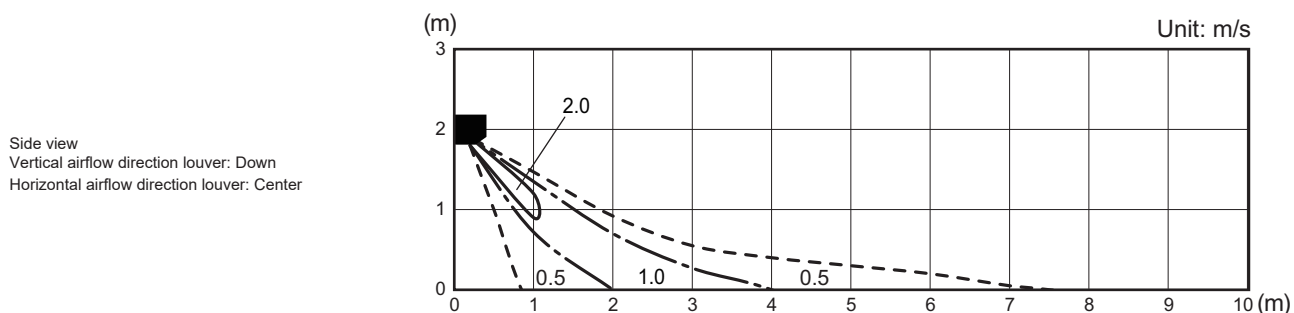
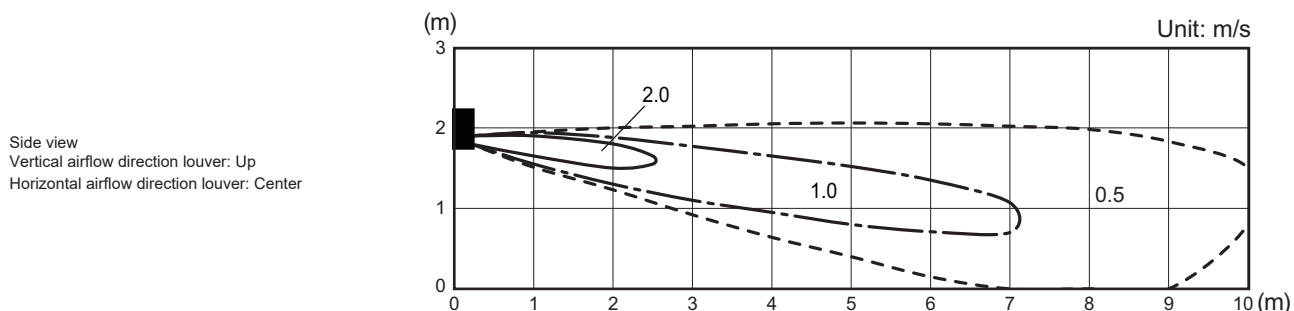
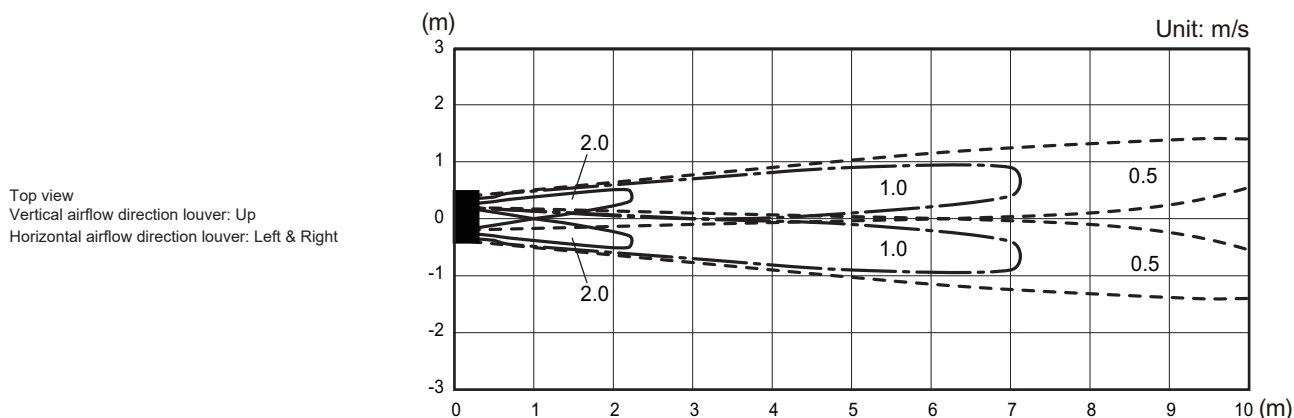
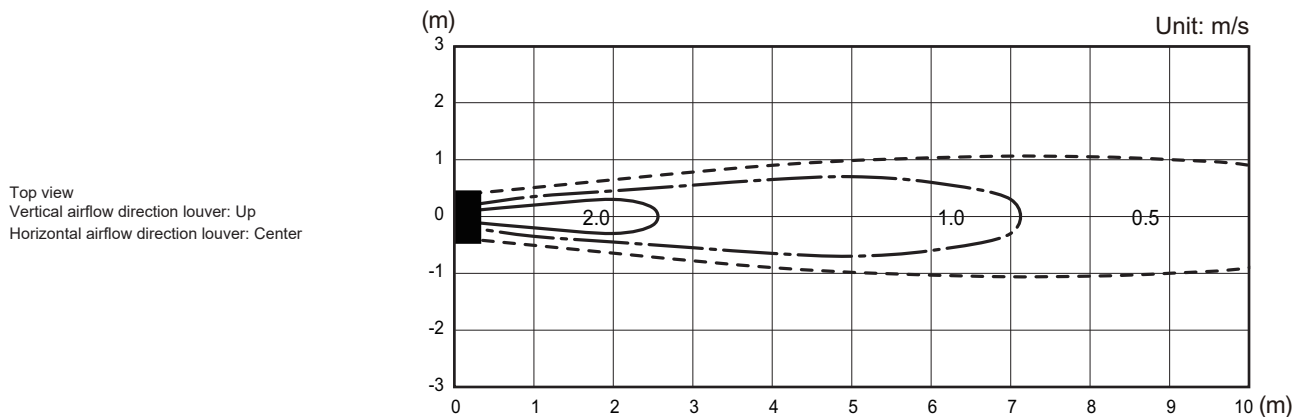

■ Models: ASYG18KMTB, ASYG22KMTB, and ASYG24KMTB

4-5 UNIT
MULTI-SPLIT TYPE

4-5 UNIT
MULTI-SPLIT TYPE

Measuring conditions	Fan speed	Operation mode
	HIGH	FAN

Top view
Vertical airflow direction louver: Up
Horizontal airflow direction louver: Center

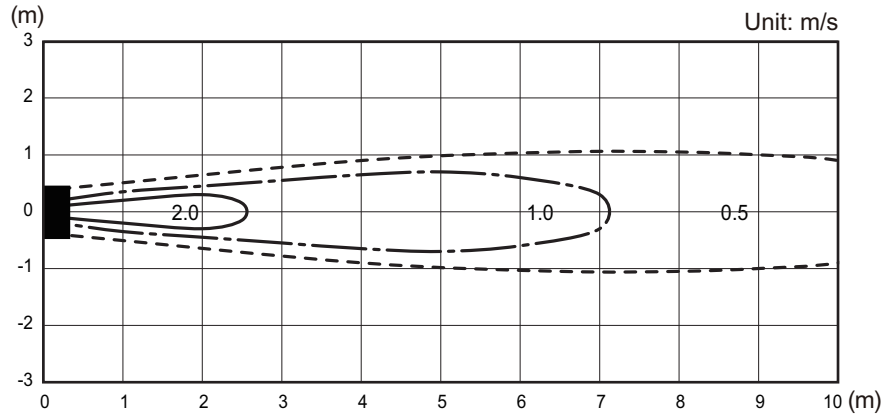

Top view
Vertical airflow direction louver: Up
Horizontal airflow direction louver: Left & Right

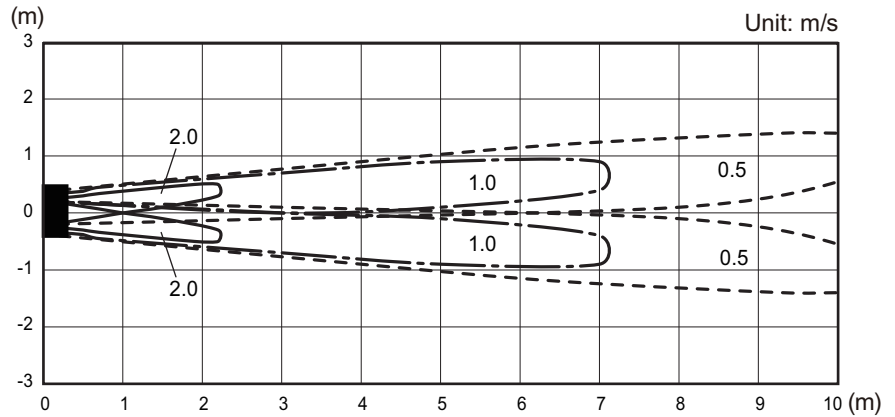

Side view
Vertical airflow direction louver: Up
Horizontal airflow direction louver: Center

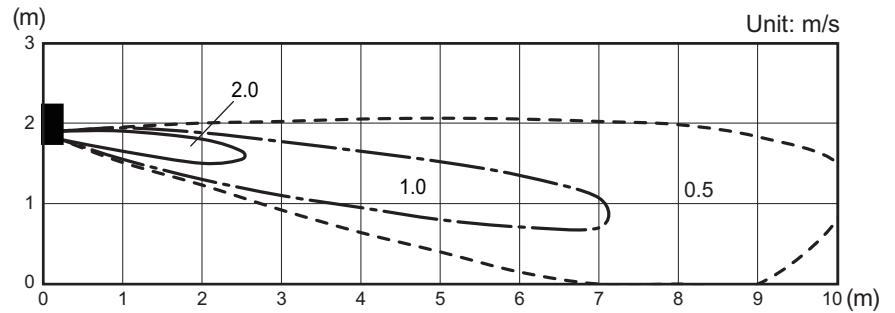

Side view
Vertical airflow direction louver: Down
Horizontal airflow direction louver: Center

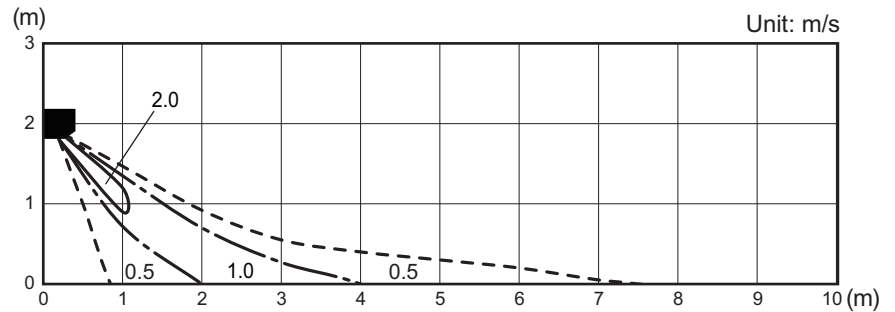

■ Models: ASYG12KGTB, ASYG14KGTB, ASYG14KMTB, ASYG14KMCC, ASYG14KETA, and ASYG14KETA-B

Measuring conditions	Fan speed	Operation mode
	HIGH	FAN

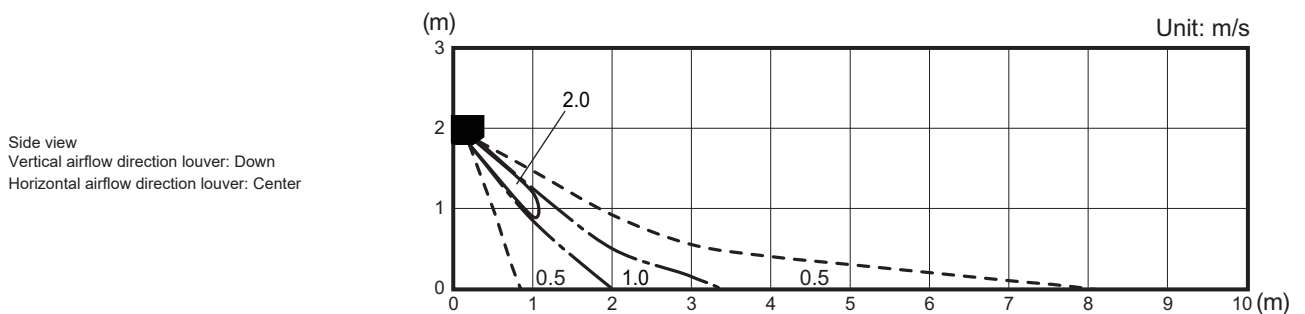
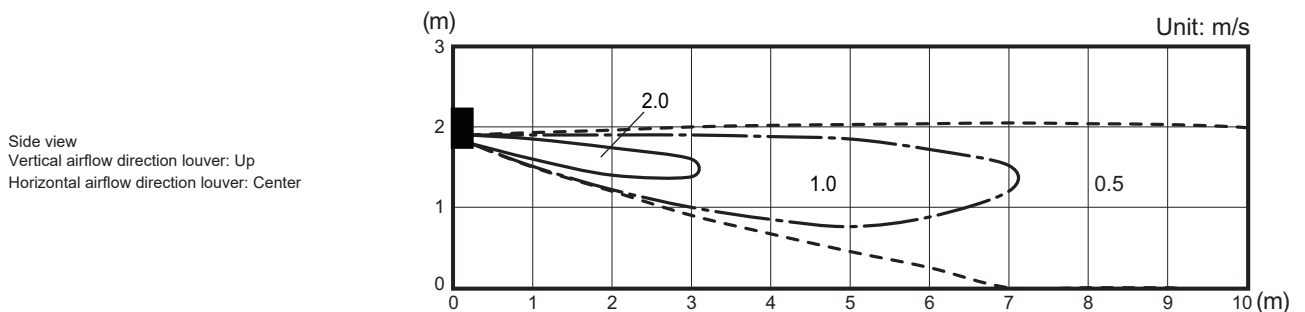
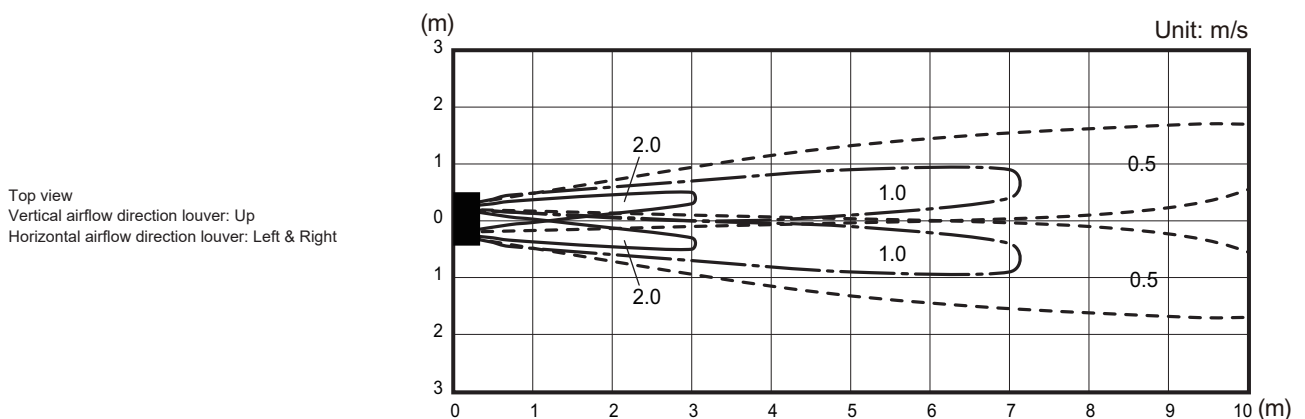
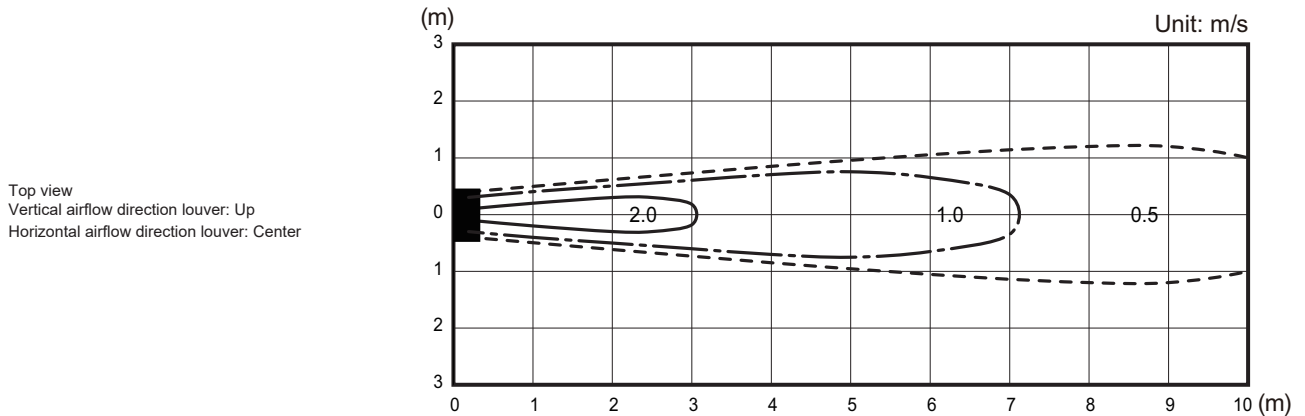

5-5. Ceiling type

Model: ABYG18KRTA

Measuring conditions	Fan speed	Operation mode
	HIGH	FAN

Top view
Vertical airflow direction louver: Up
Horizontal airflow direction louver: Center

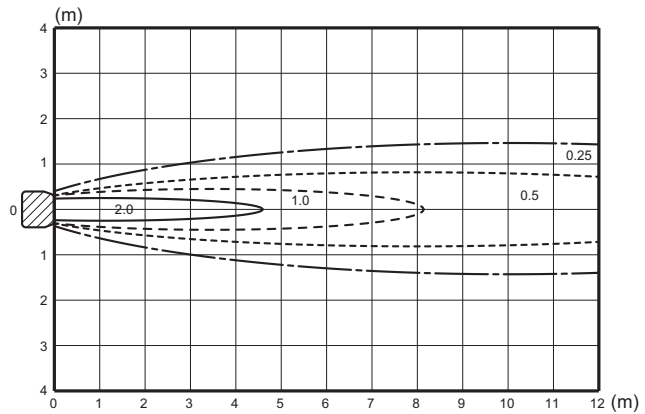

Top view
Vertical airflow direction louver: Up
Horizontal airflow direction louver: Left & Right

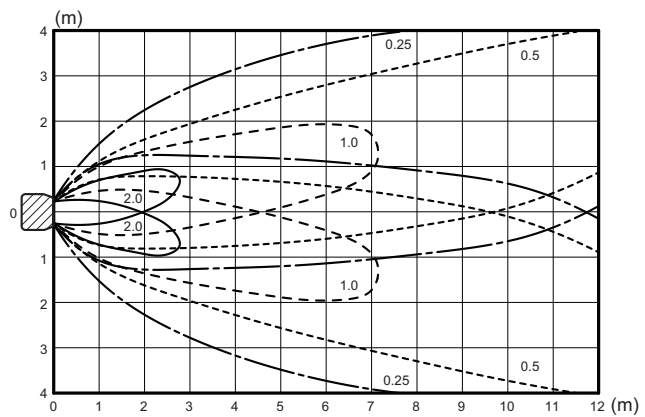

Side view
Vertical airflow direction louver: Up
Horizontal airflow direction louver: Center

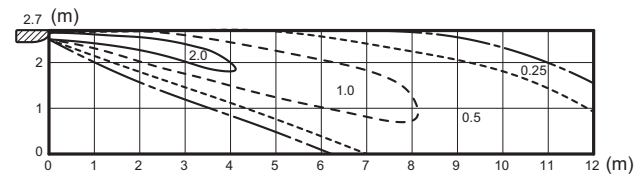

Side view
Vertical airflow direction louver: Down
Horizontal airflow direction louver: Center

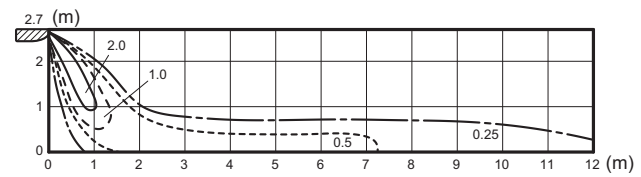

Model: ABYG22KRTA

Measuring conditions	Fan speed	Operation mode
	HIGH	FAN

Top view
Vertical airflow direction louver: Up
Horizontal airflow direction louver: Center

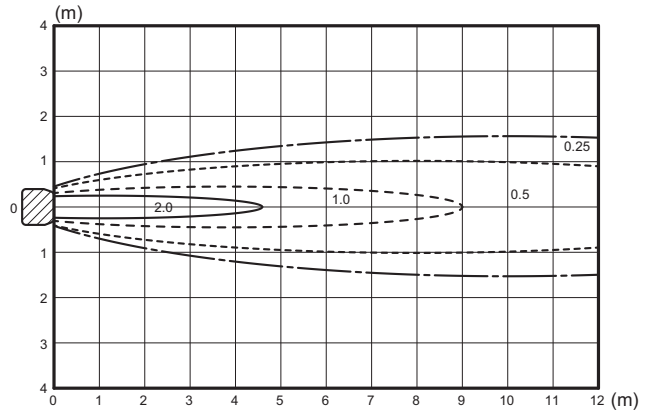

Top view
Vertical airflow direction louver: Up
Horizontal airflow direction louver: Left & Right

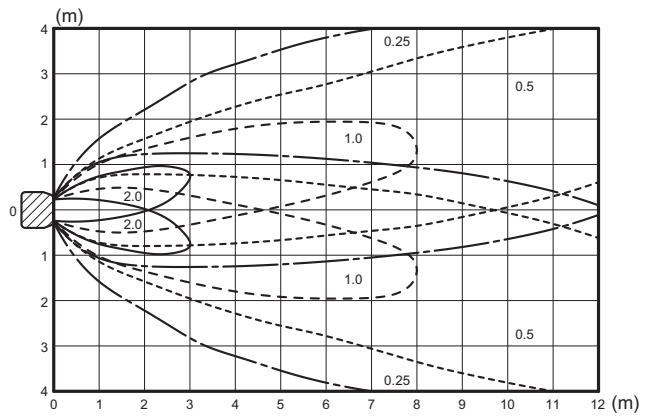

Side view
Vertical airflow direction louver: Up
Horizontal airflow direction louver: Center

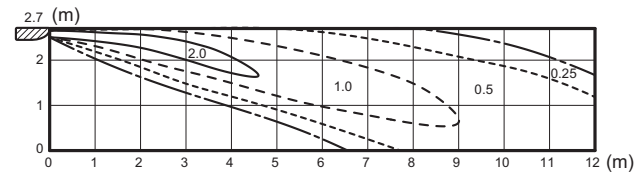

Side view
Vertical airflow direction louver: Down
Horizontal airflow direction louver: Center

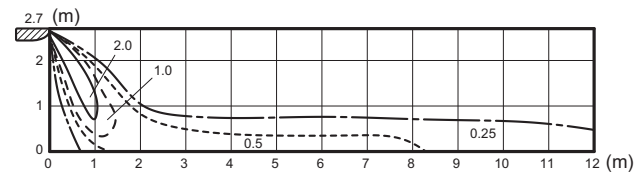

5-6. Floor type

Models: AGYG09KVCA, AGYG12KVCA, and AGYG14KVCA

Measuring conditions	Fan speed	Operation mode	Fan select
	HIGH	FAN	Upper and lower

Top view
Vertical airflow direction louver: Up
Horizontal airflow direction louver: Center

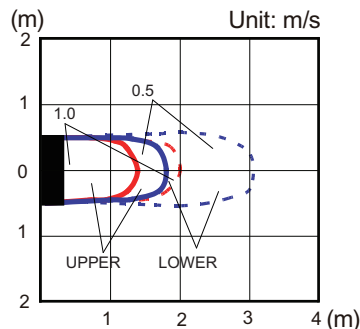

Top view
Vertical airflow direction louver: Up
Horizontal airflow direction louver: Left & Right

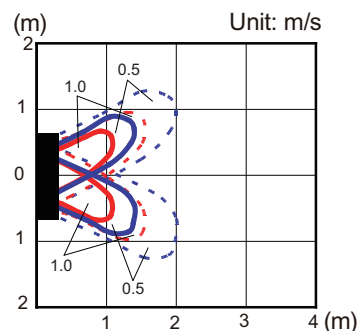

Side view
Vertical airflow direction louver: Up
Horizontal airflow direction louver: Center

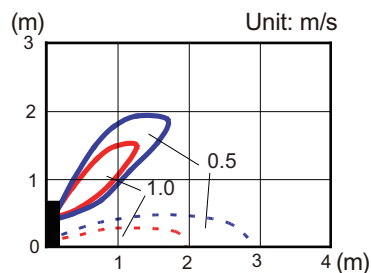

Side view
Vertical airflow direction louver: Down
Horizontal airflow direction louver: Center

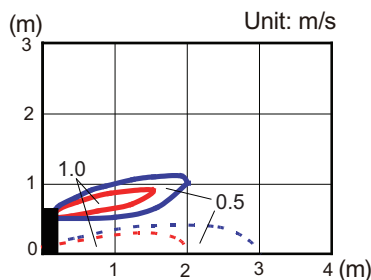

6. Fan performance

6-1. Mini duct type

Model: ARXG07KSLAP

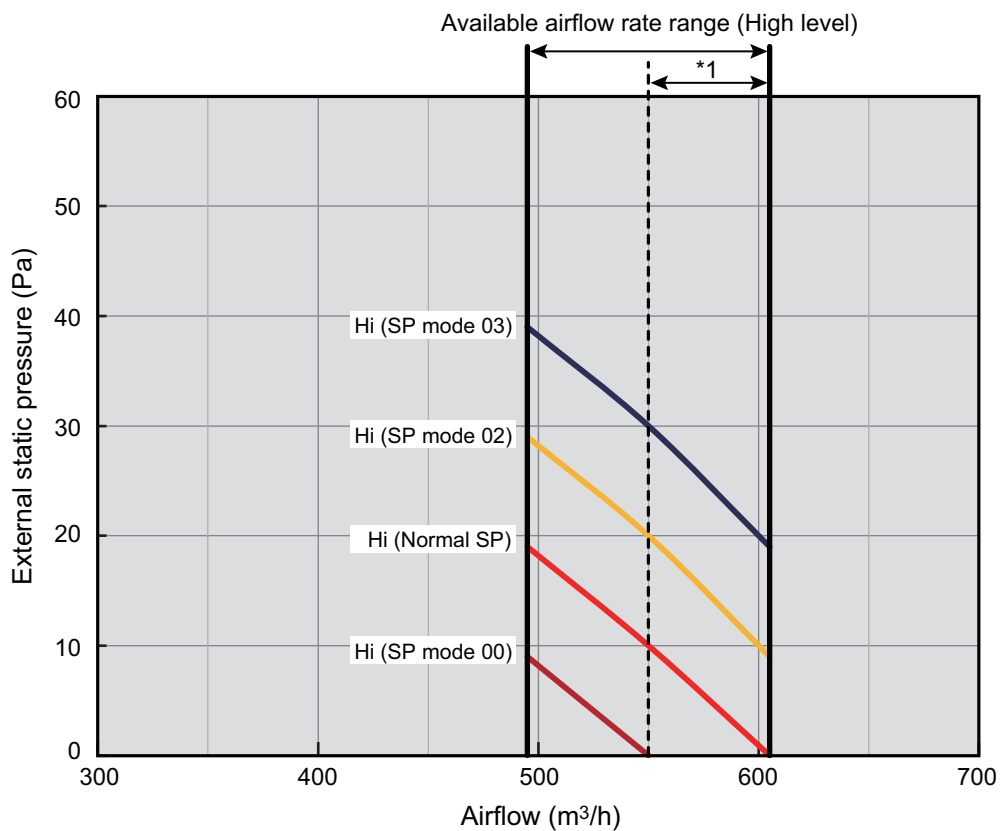
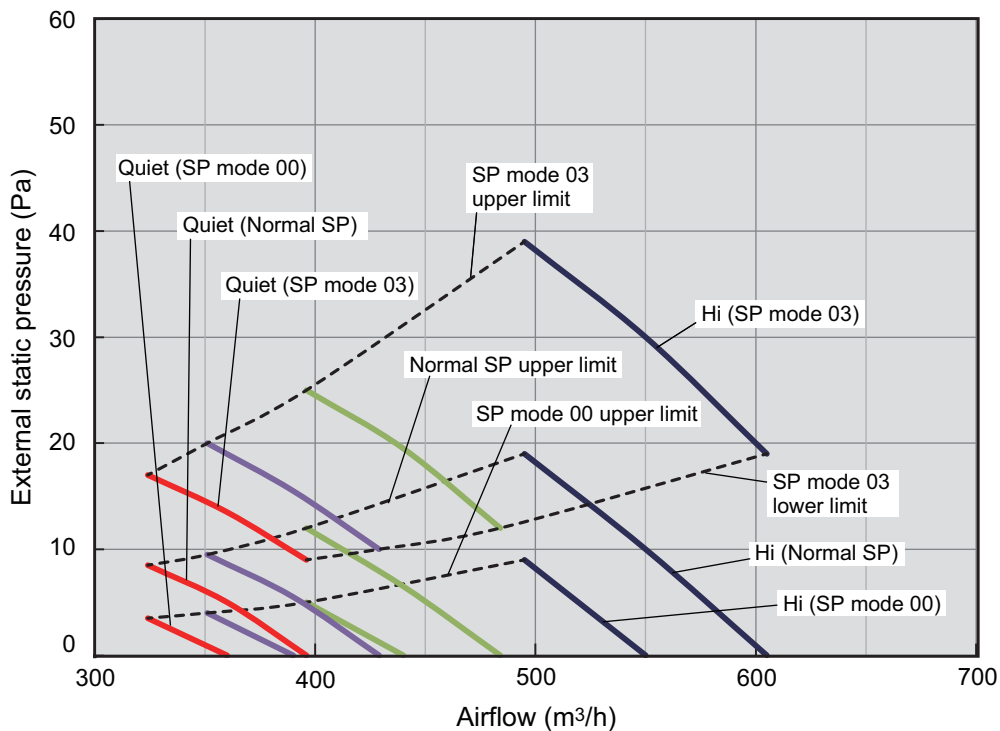

*1: Available airflow rate range when Auto louver grille (option) is installed.

Fan speed: HIGH

Vertical airflow direction louver: Up

● Characteristics of air volume and capacity

• Cooling

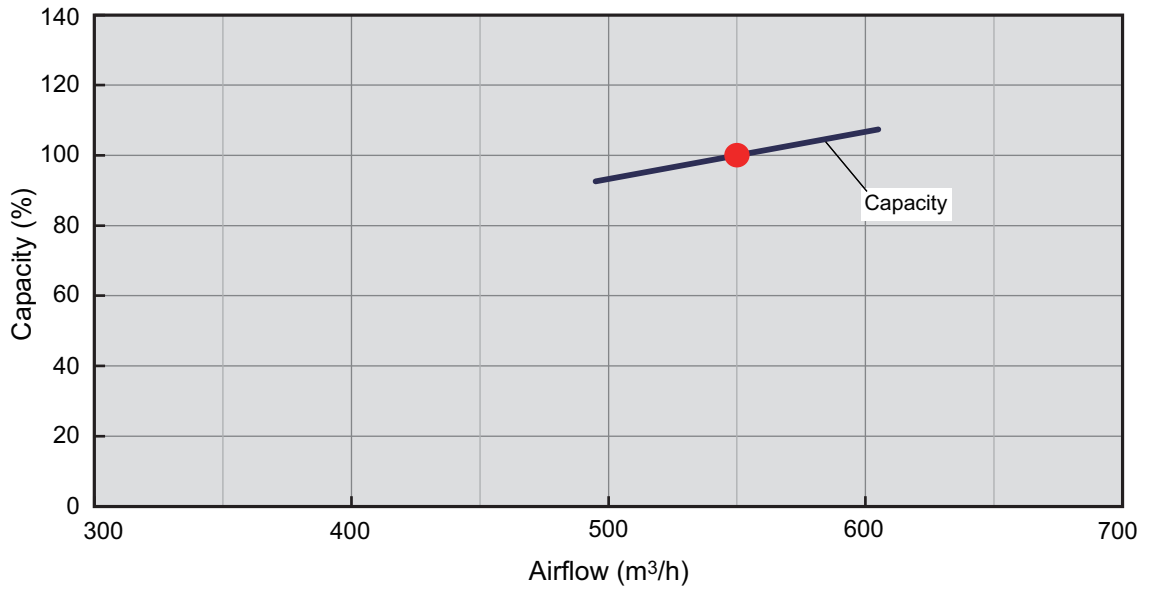

• Heating

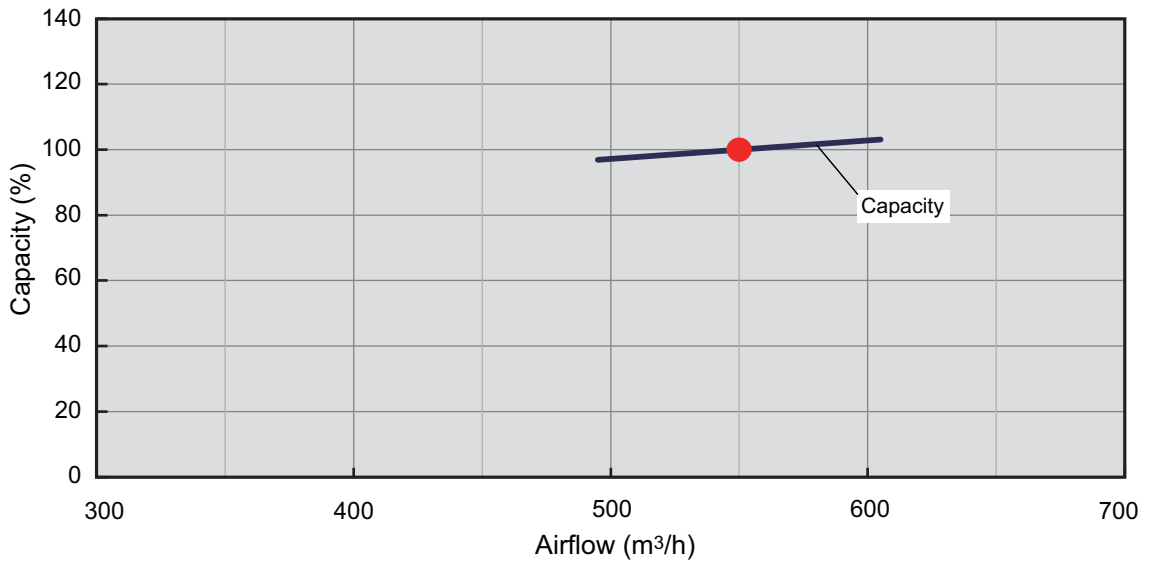

■ Model: ARXG09KSLAP

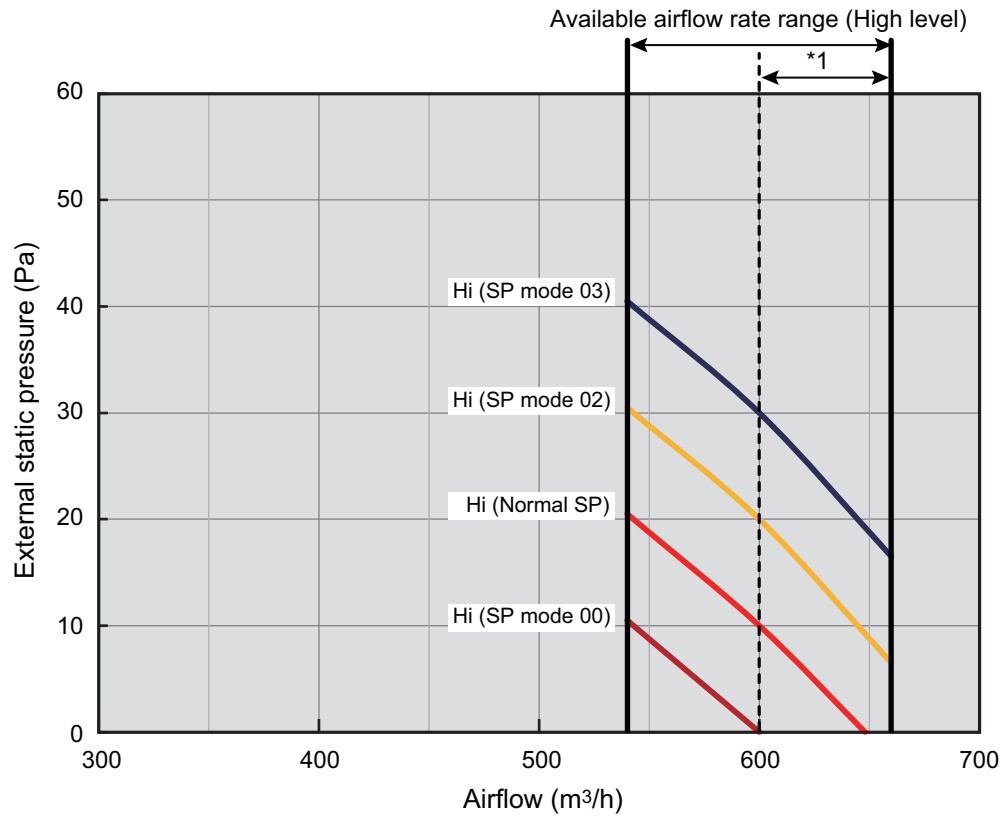
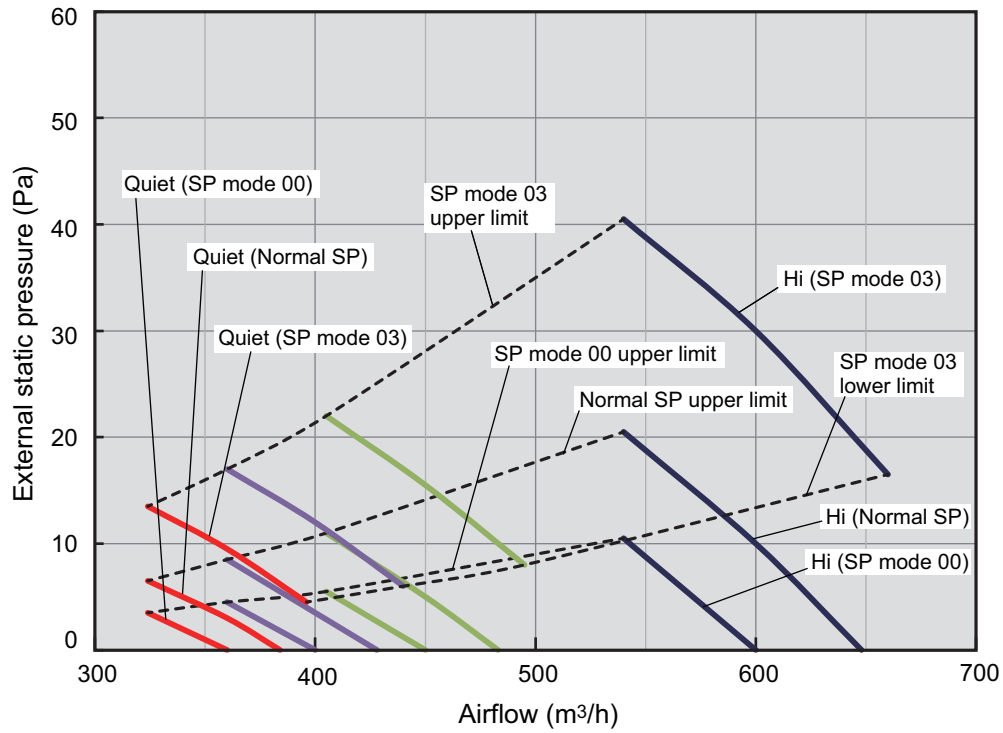

*1: Available airflow rate range when Auto louver grille (option) is installed.
 Fan speed: HIGH
 Vertical airflow direction louver: Up

● Characteristics of air volume and capacity

• Cooling

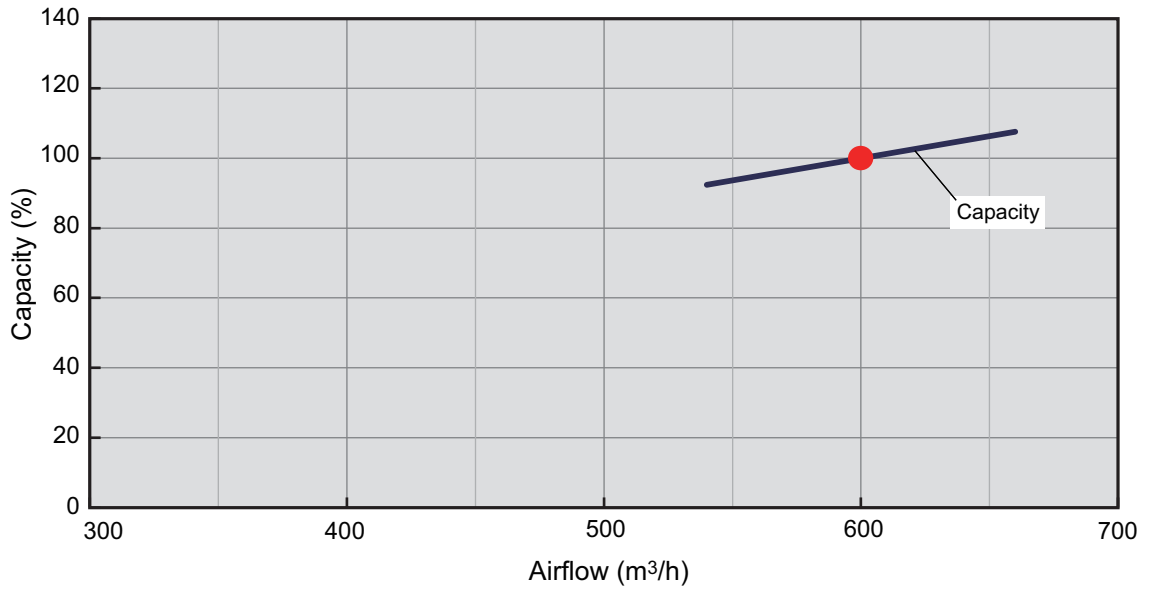

• Heating

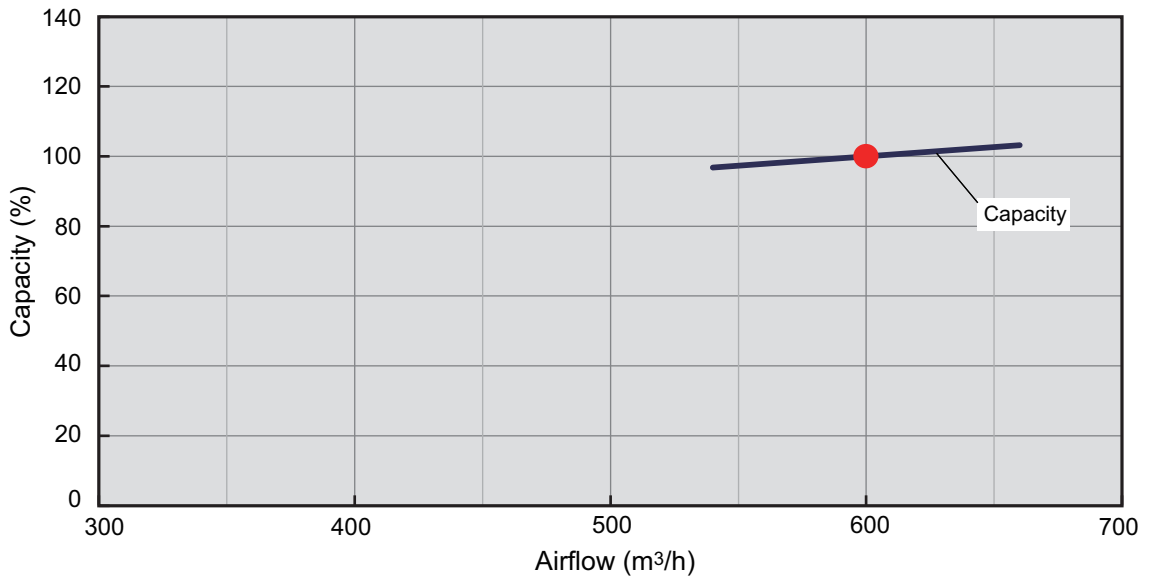

Model: ARXG12KSLAP

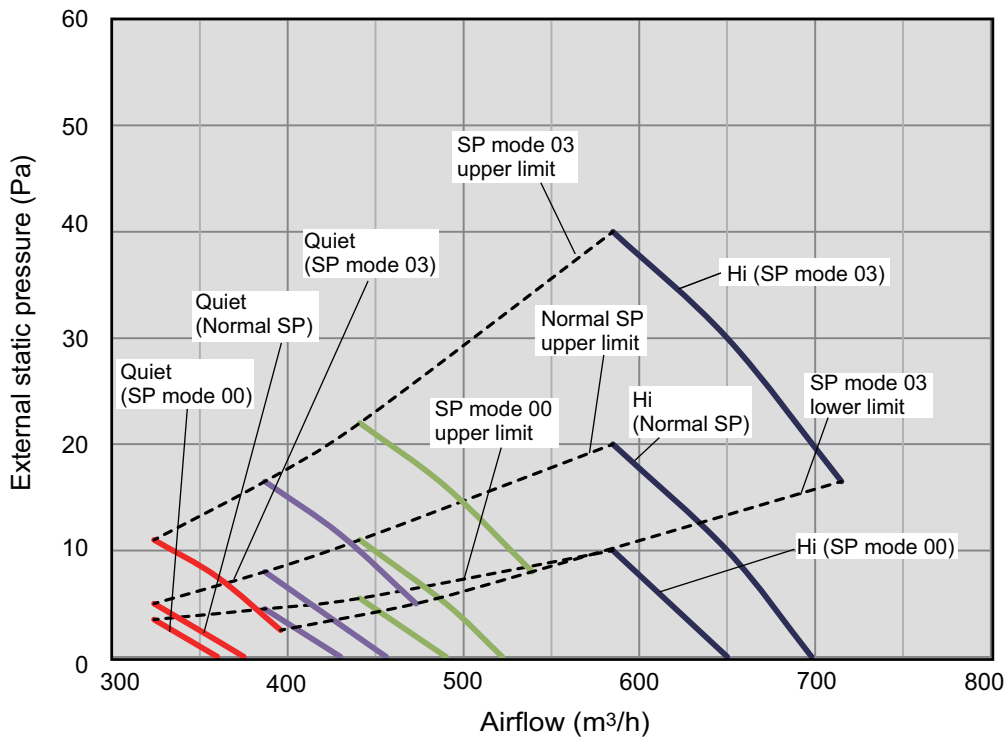

Available airflow rate range (High level)

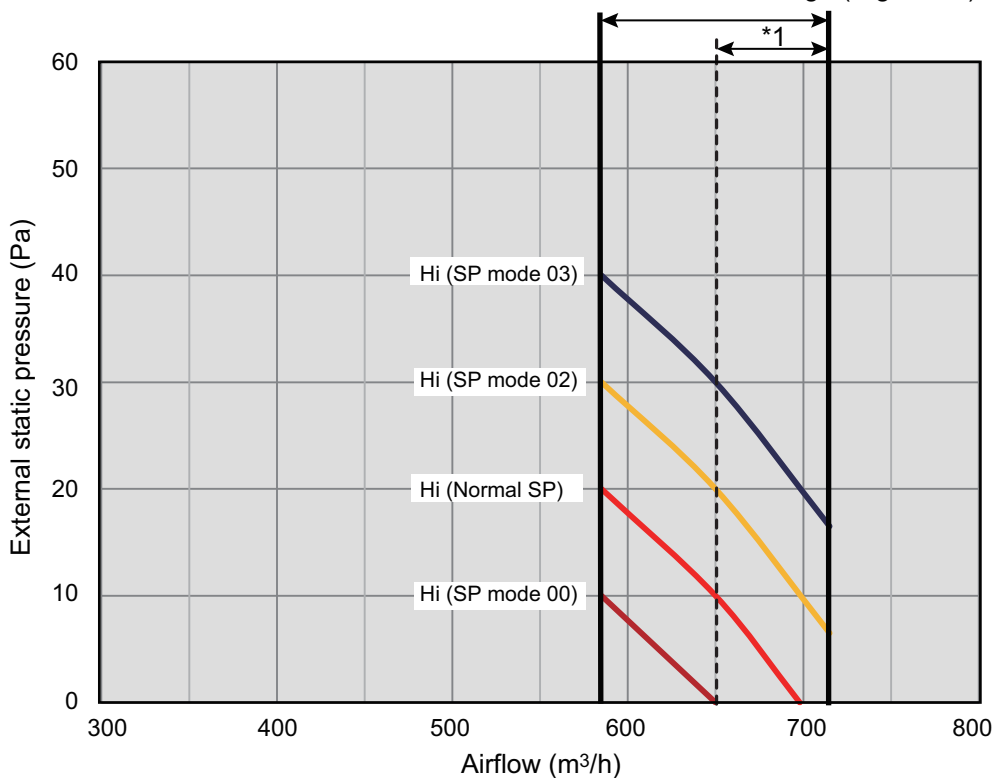

*1: Available airflow rate range when Auto louver grille (option) is installed.

Fan speed: HIGH

Vertical airflow direction louver: Up

● Characteristics of air volume and capacity

• Cooling

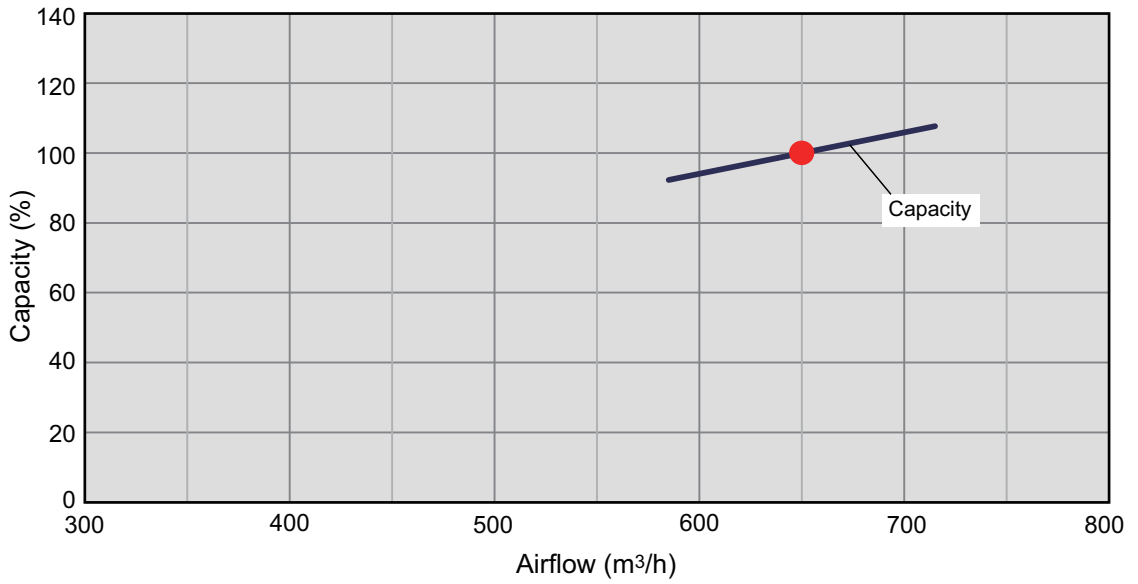

• Heating

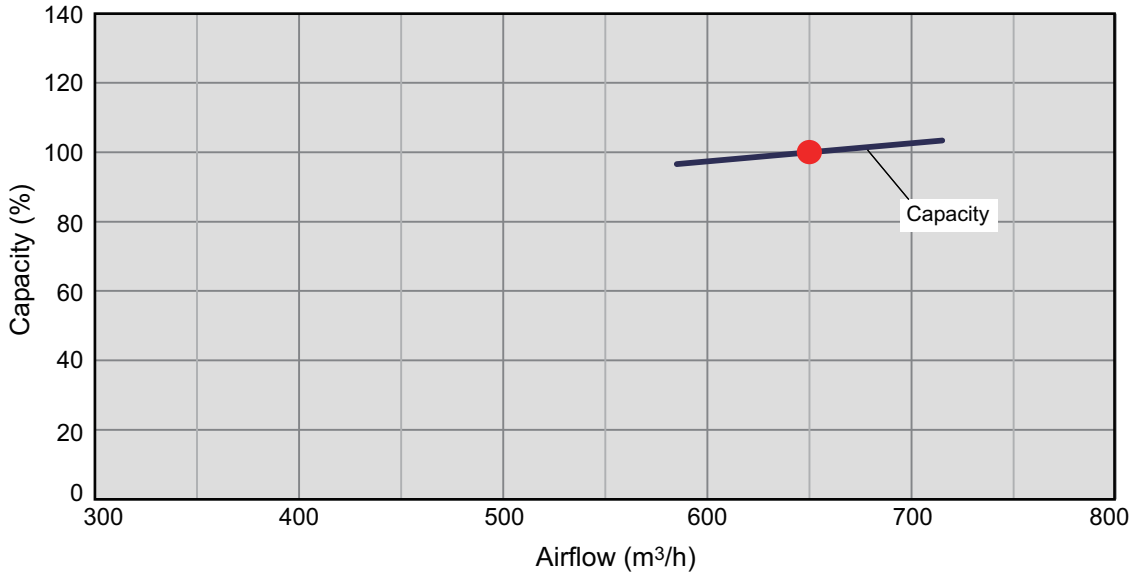

Model: ARXG14KSLAP

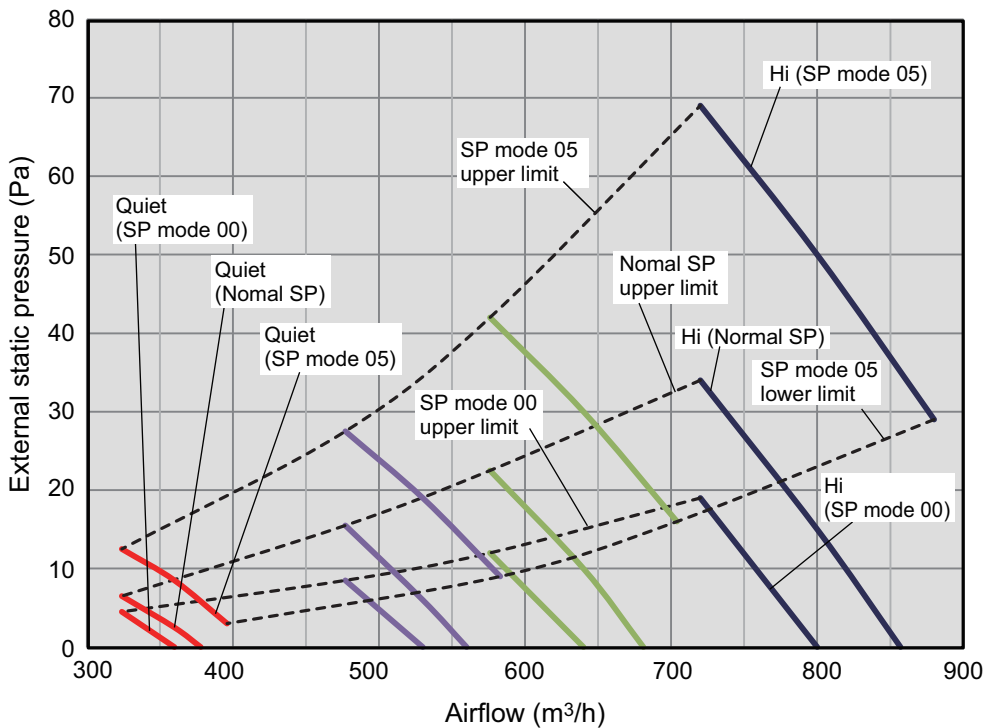

Available airflow rate range (High level)

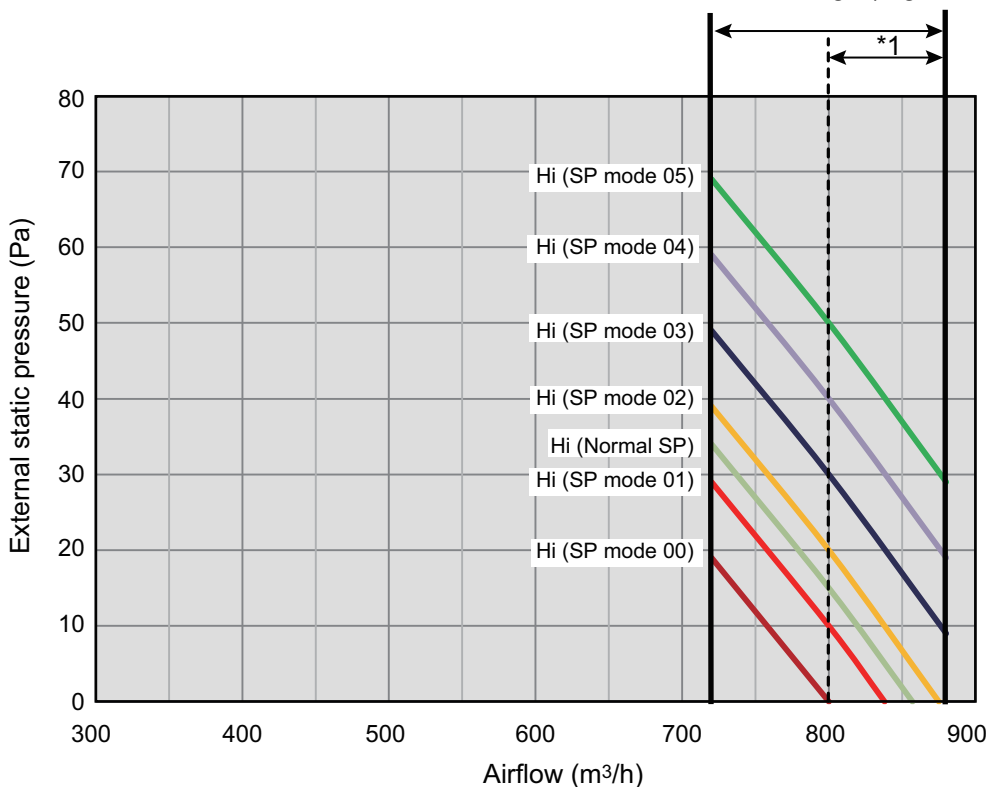

*1: Available airflow rate range when Auto louver grille (option) is installed.
 Fan speed: HIGH
 Vertical airflow direction louver: Up

● Characteristics of air volume and capacity

• Cooling

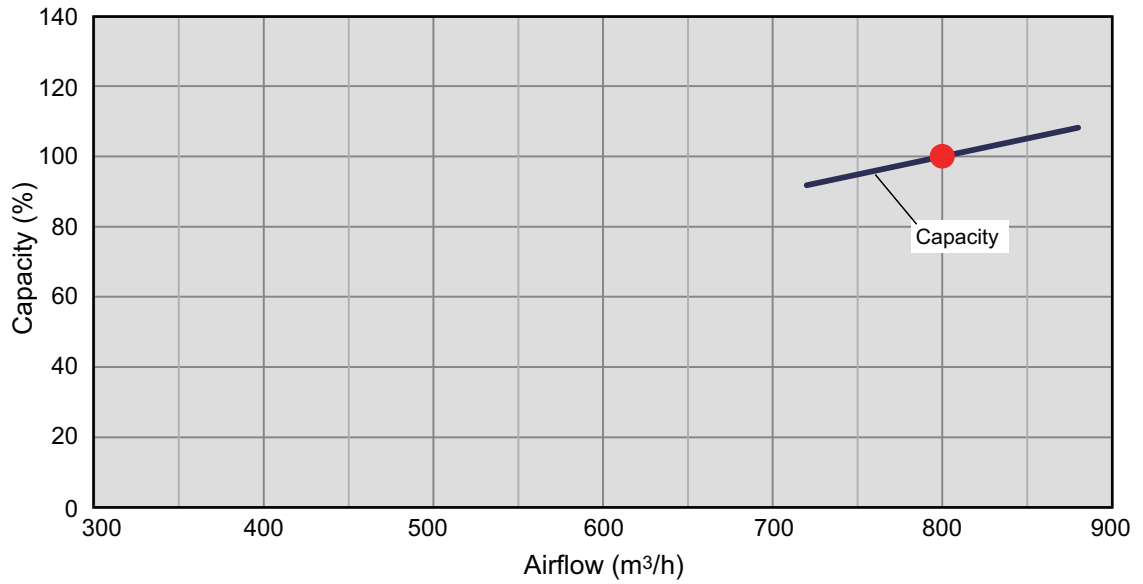

• Heating

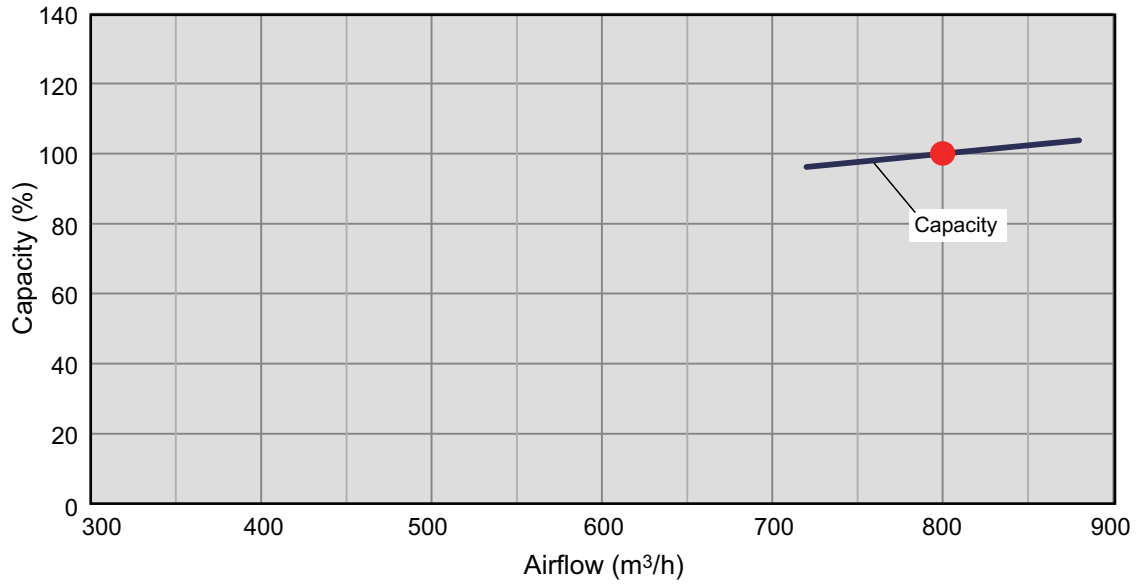

Model: ARXG18KSLAP

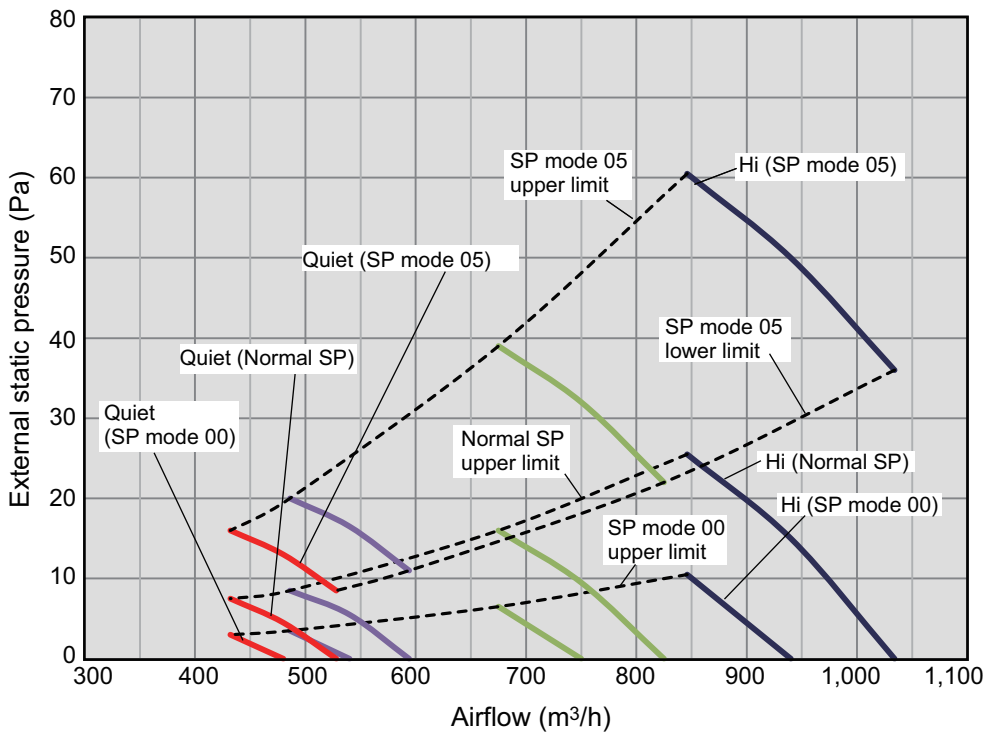

Available airflow rate range (High level)

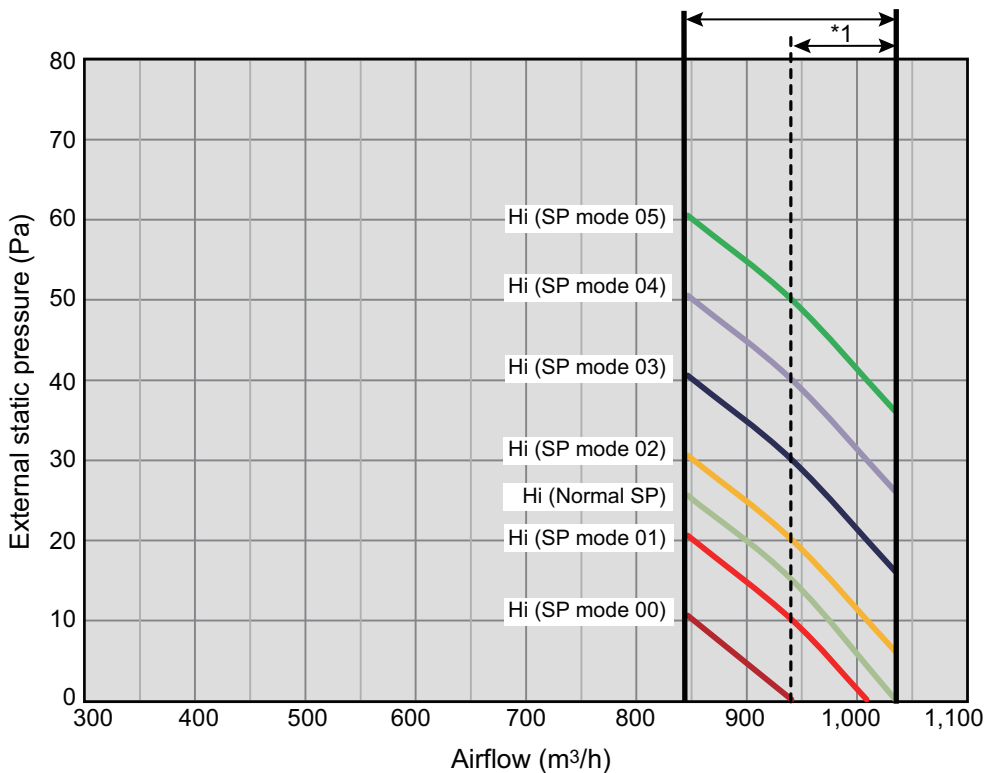

*1: Available airflow rate range when Auto louver grille (option) is installed.
Fan speed: HIGH
Vertical airflow direction louver: Up

● Characteristics of air volume and capacity

• Cooling

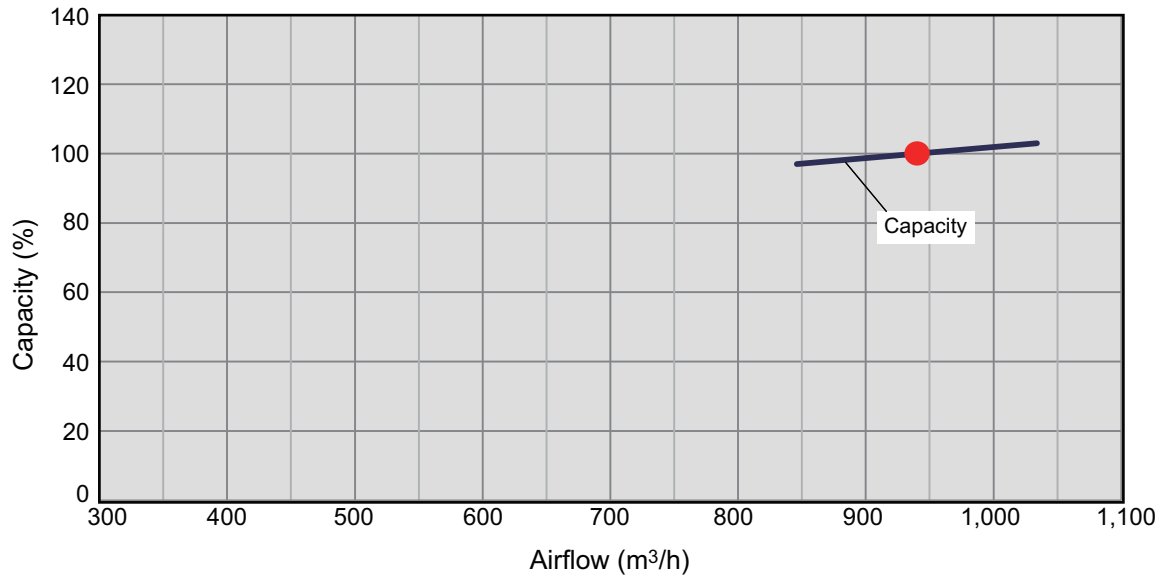

• Heating

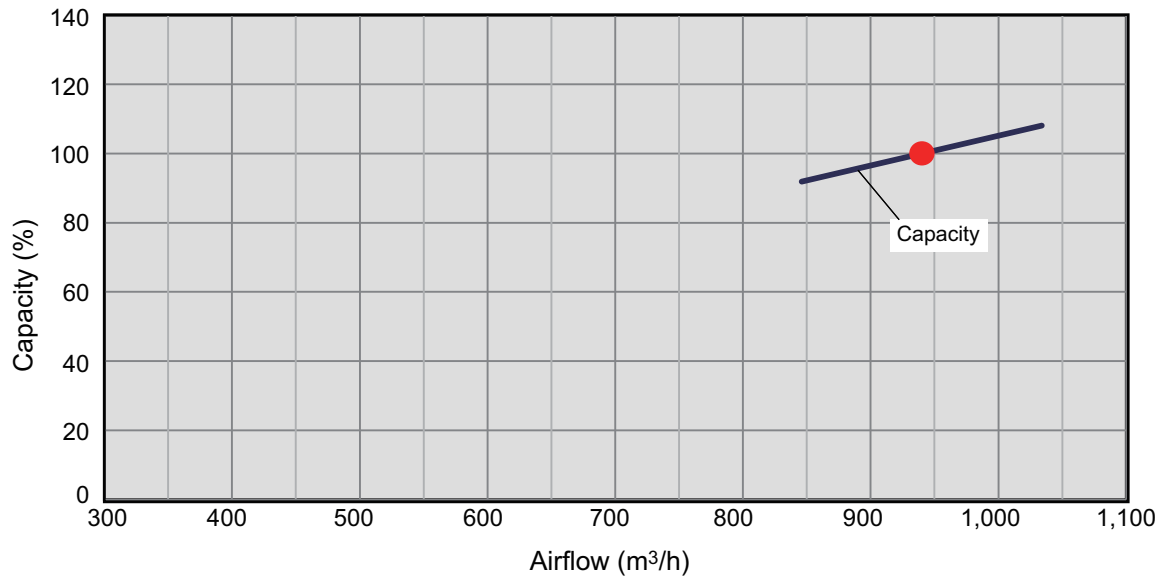

6-2. Slim duct type

Model: ARXG07KLLAP

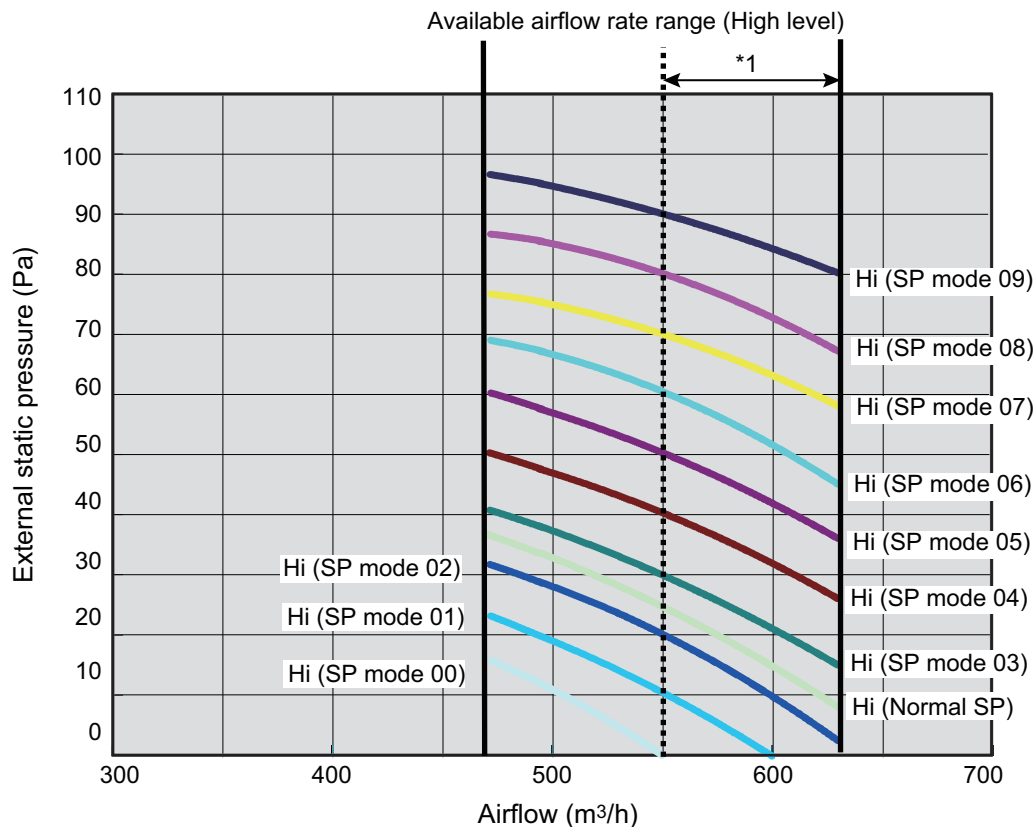
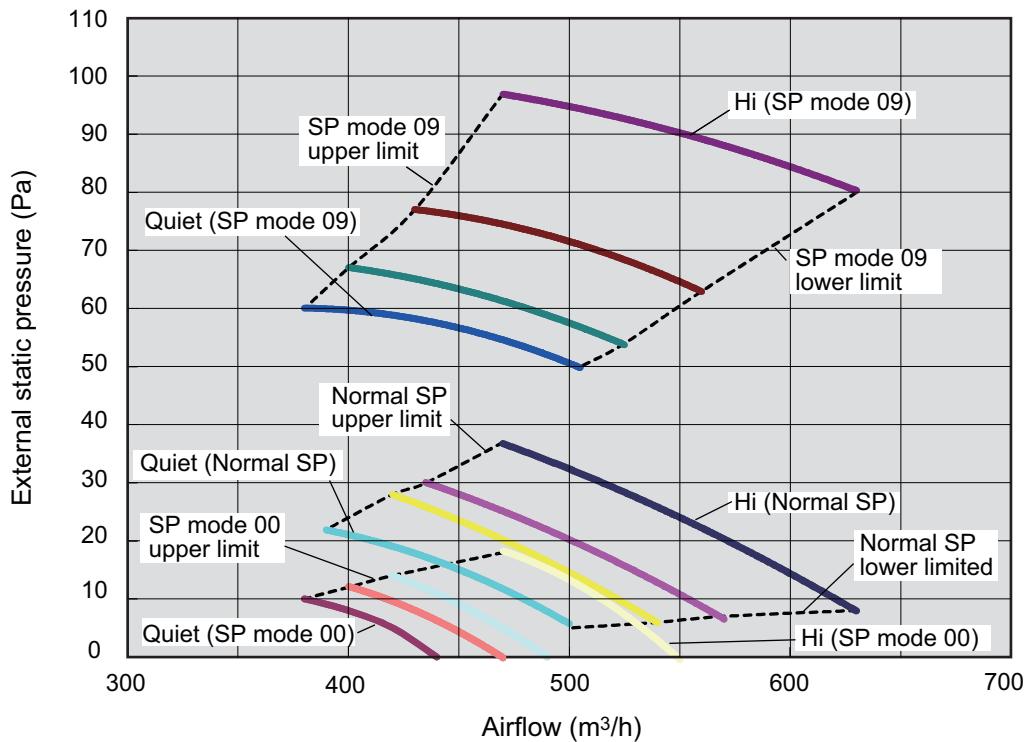

*1: Available airflow rate range when Auto louver grille (option) is installed.
 Fan speed: HIGH
 Vertical airflow direction louver: Up

● Characteristics of air volume and capacity

• Cooling

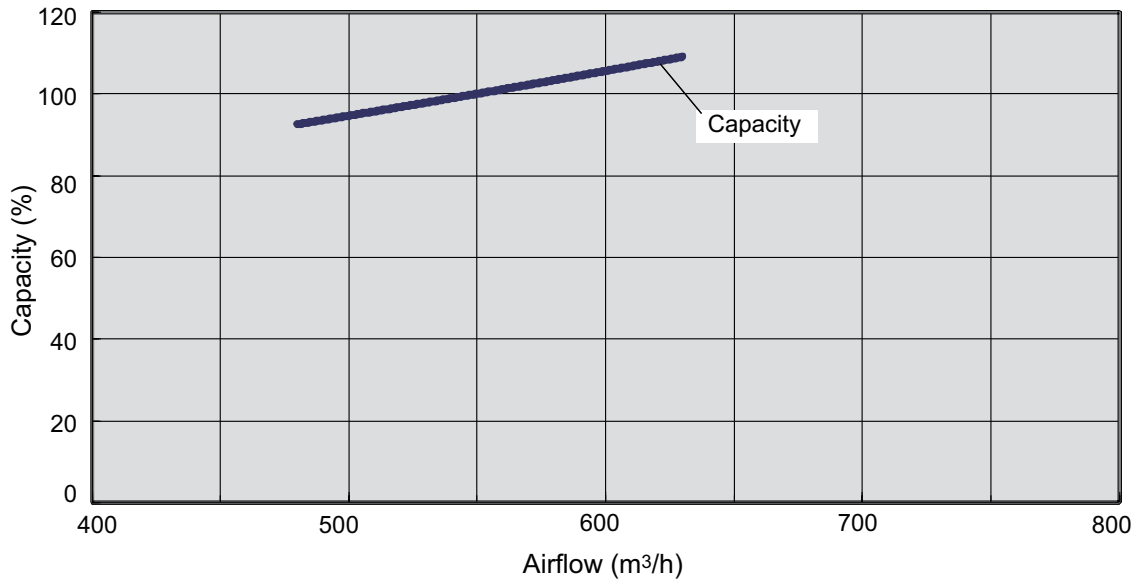

• Heating

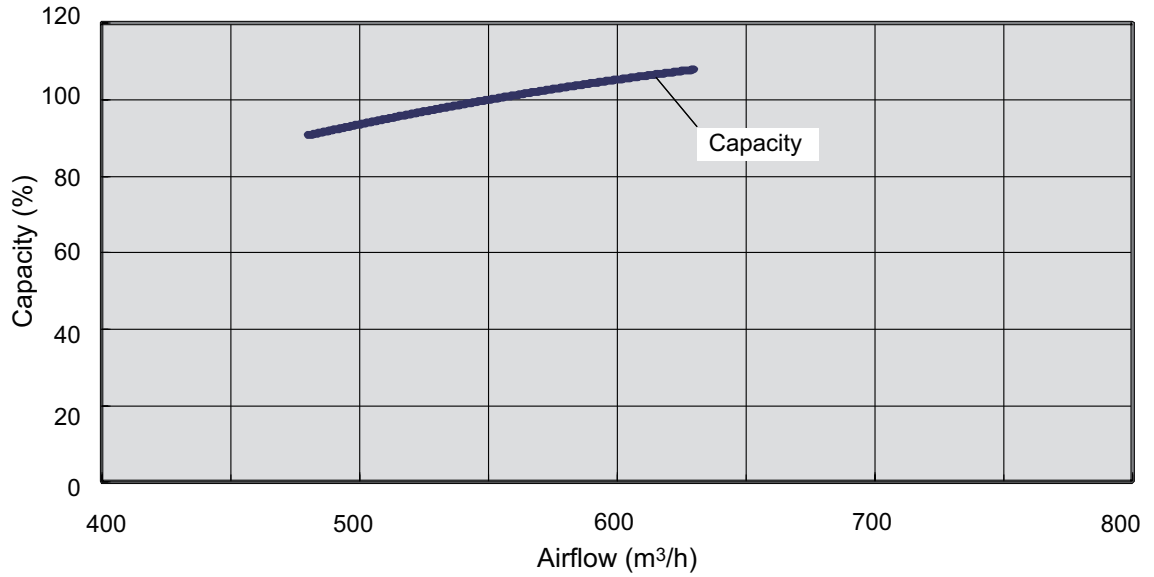

Model: ARXG09KLLAP

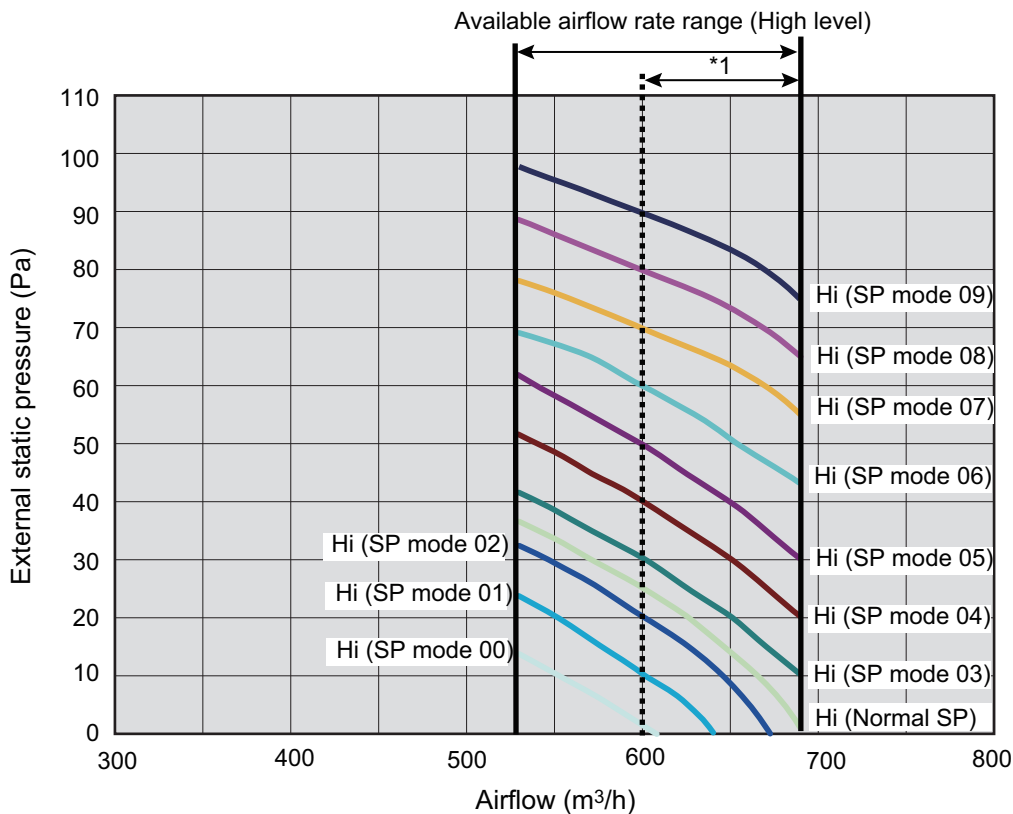
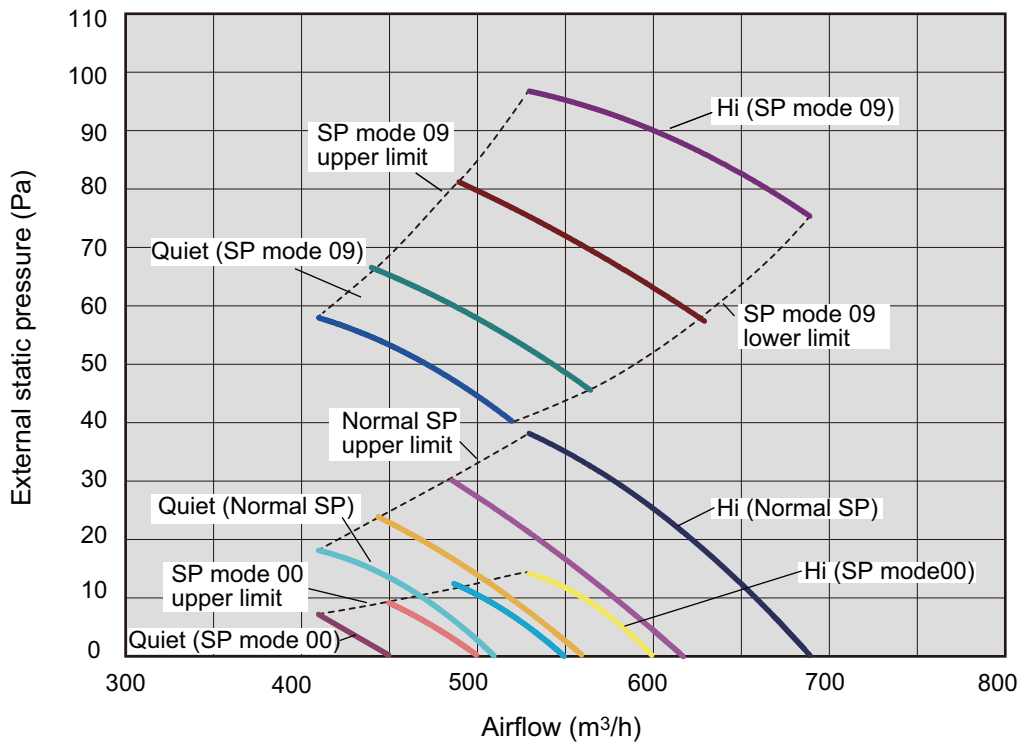

*1: Available airflow rate range when Auto louver grille (option) is installed.
 Fan speed: HIGH
 Vertical airflow direction louver: Up

● Characteristics of air volume and capacity

• Cooling

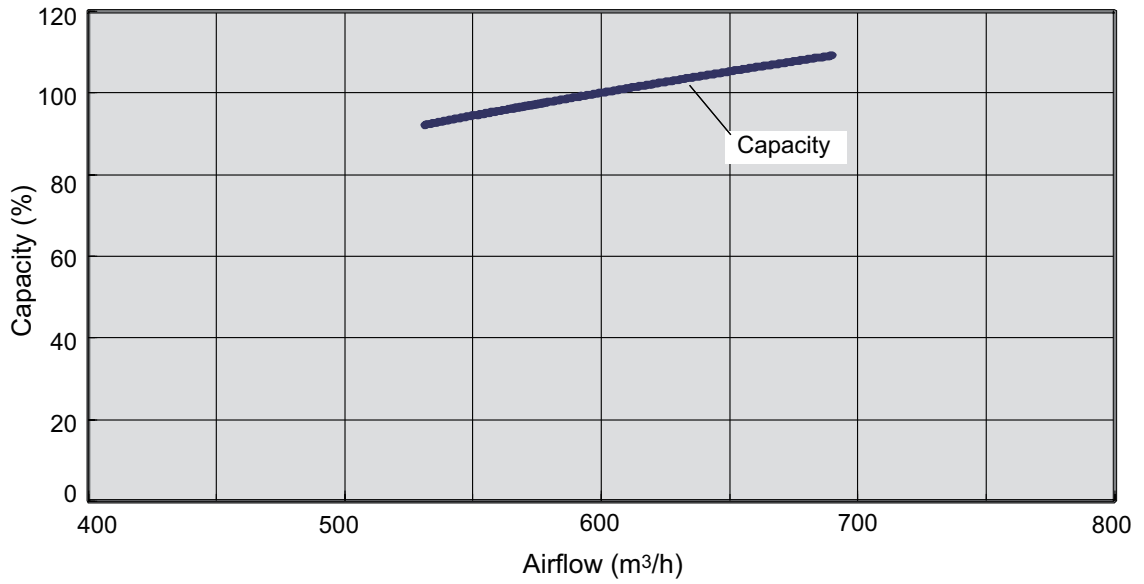

• Heating

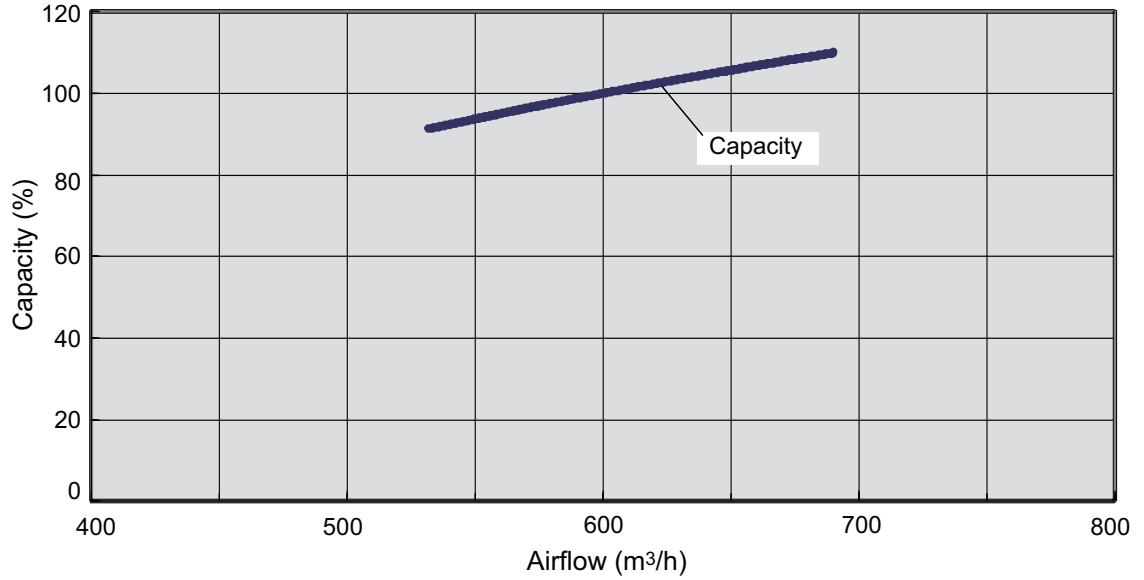

Model: ARXG12KLLAP

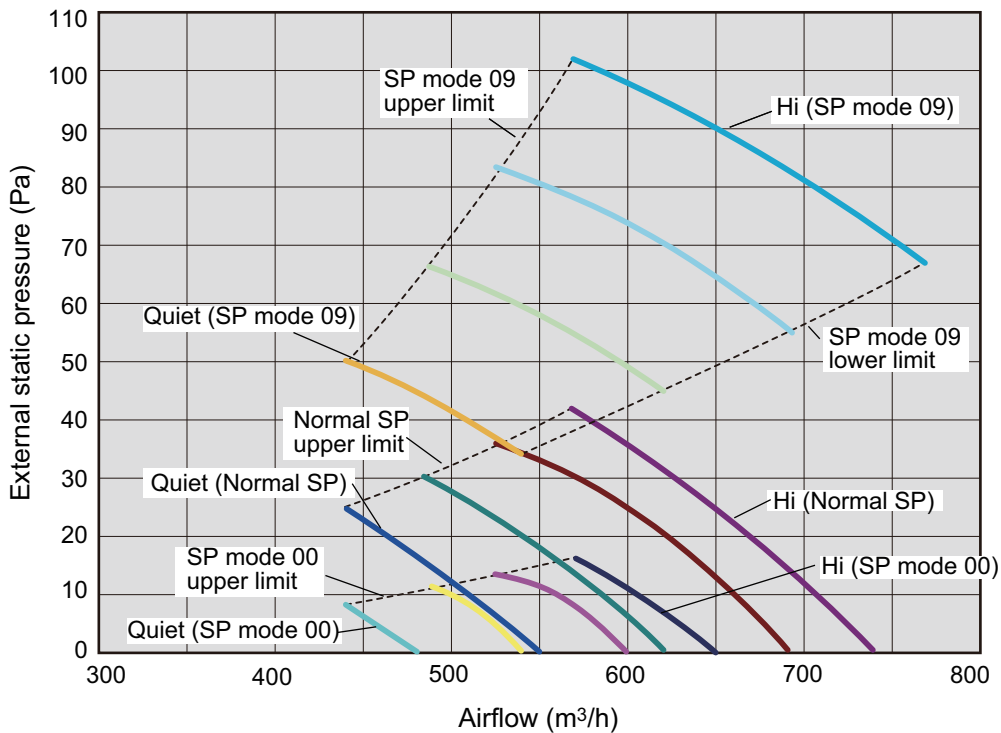

Available airflow rate range (High level)

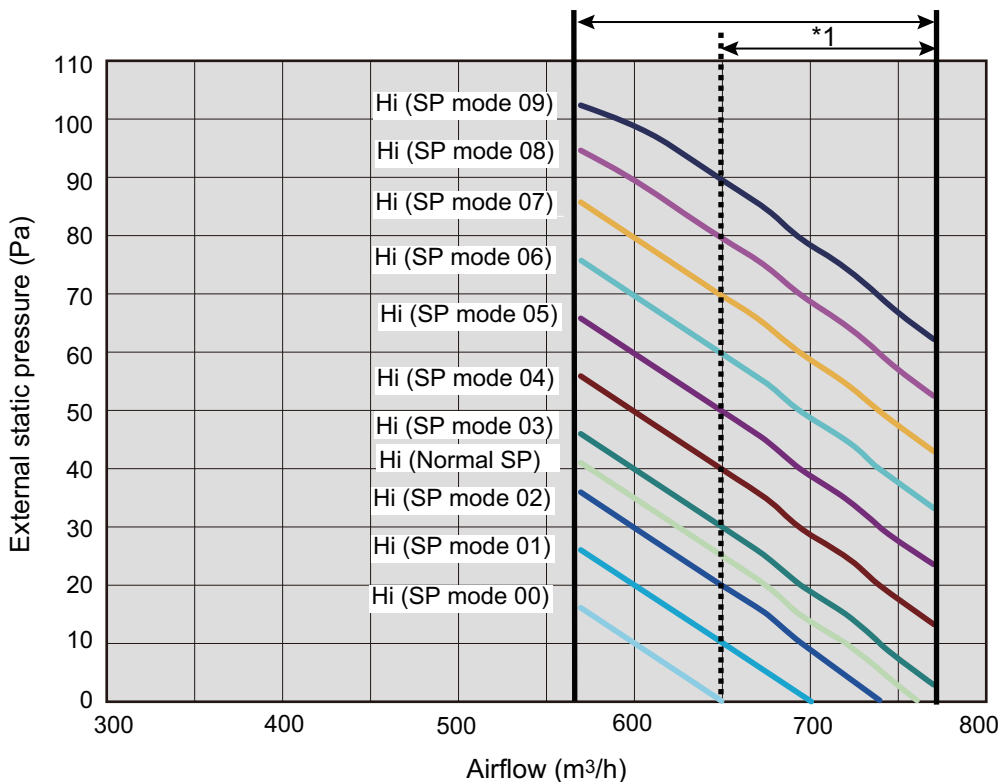

*1: Available airflow rate range when Auto louver grille (option) is installed.
 Fan speed: HIGH
 Vertical airflow direction louver: Up

● Characteristics of air volume and capacity

• Cooling

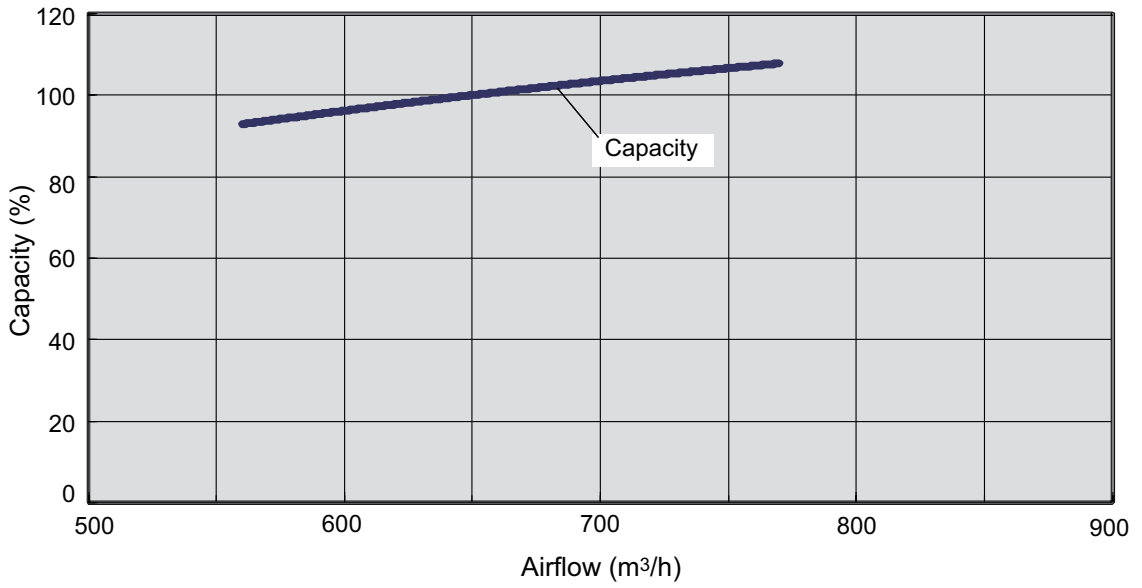

• Heating

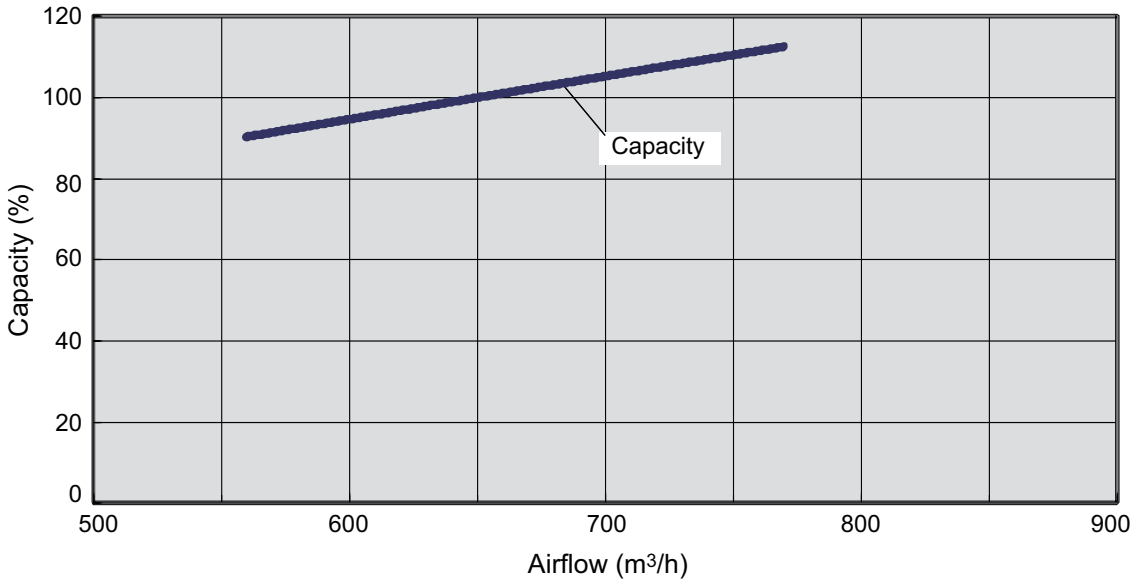

Model: ARXG14KLLAP

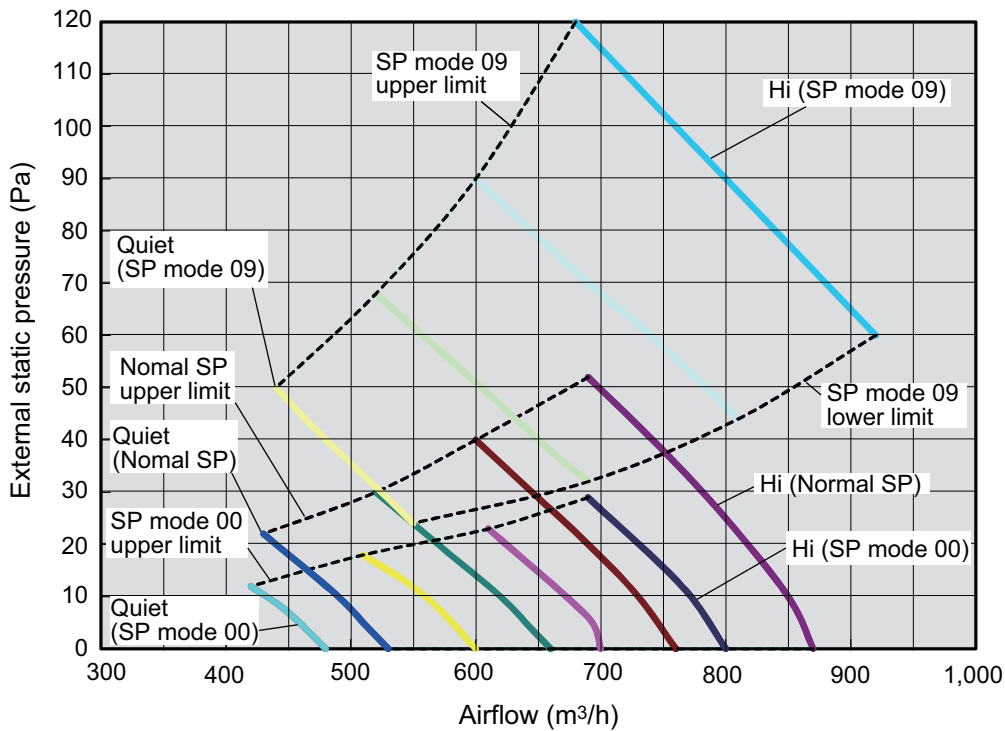

Available airflow rate range (High level)

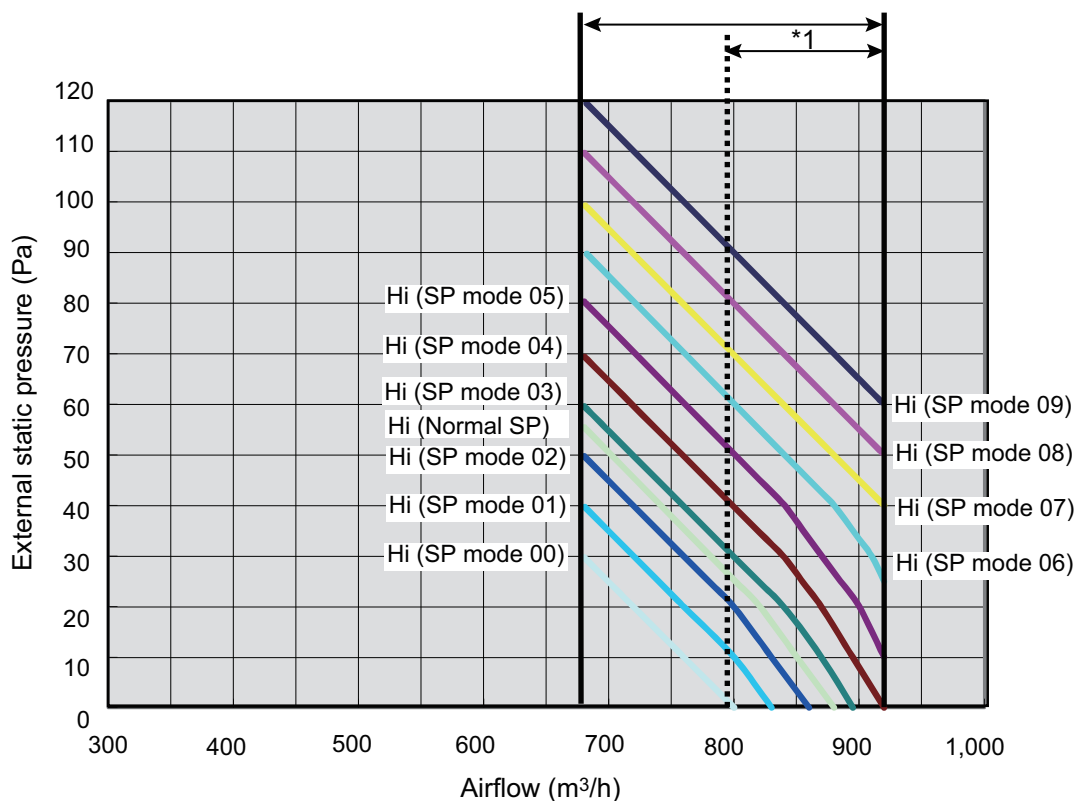

*1: Available airflow rate range when Auto louver grille (option) is installed.

Fan speed: HIGH

Vertical airflow direction louver: Up

● Characteristics of air volume and capacity

• Cooling

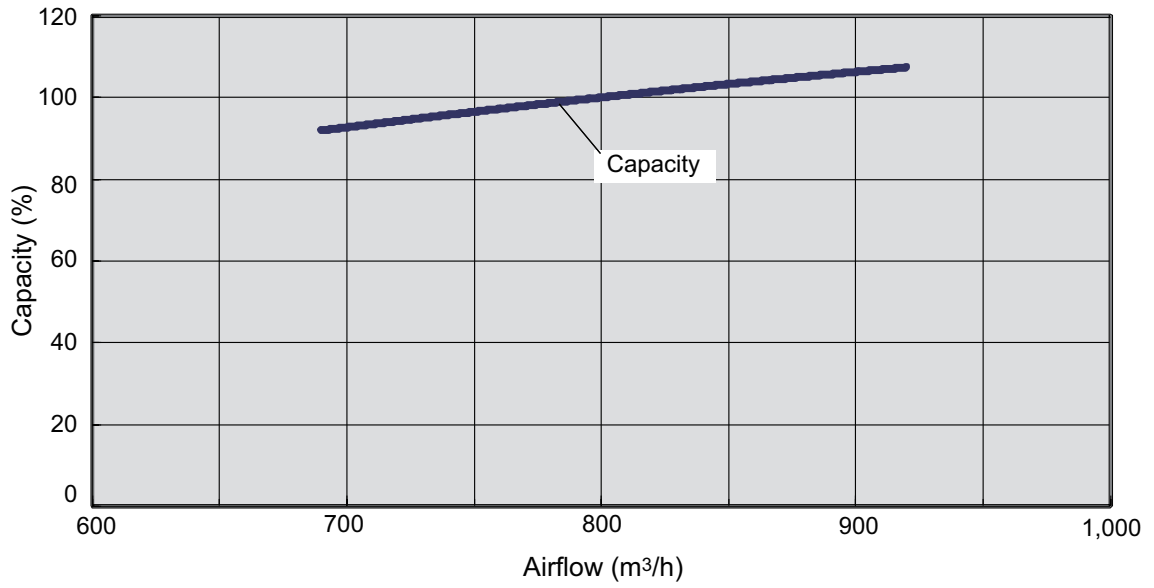

• Heating

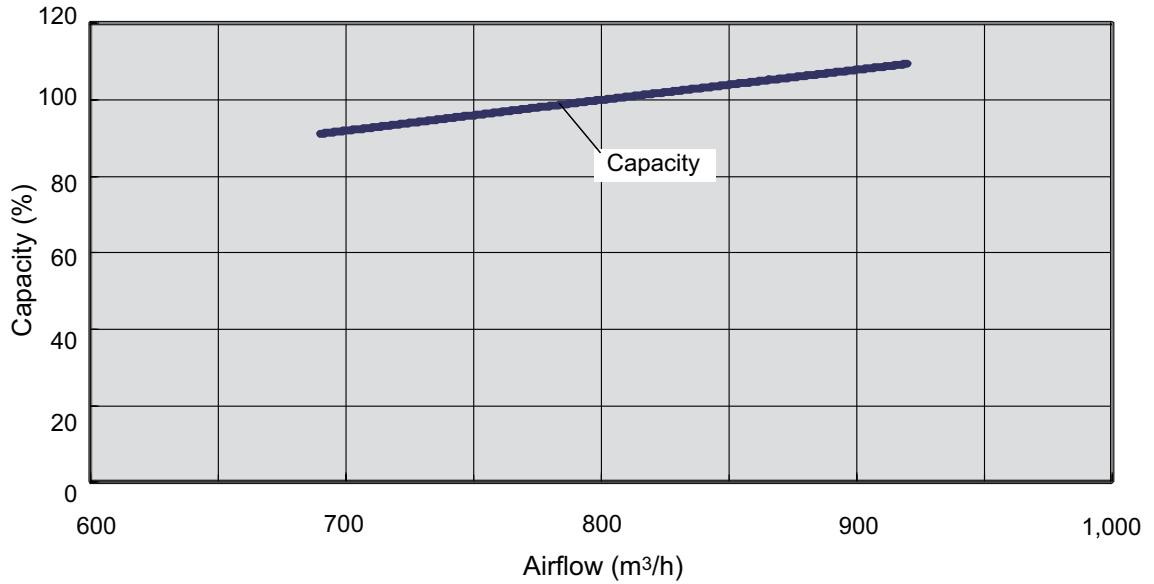

Model: ARXG18KLLAP

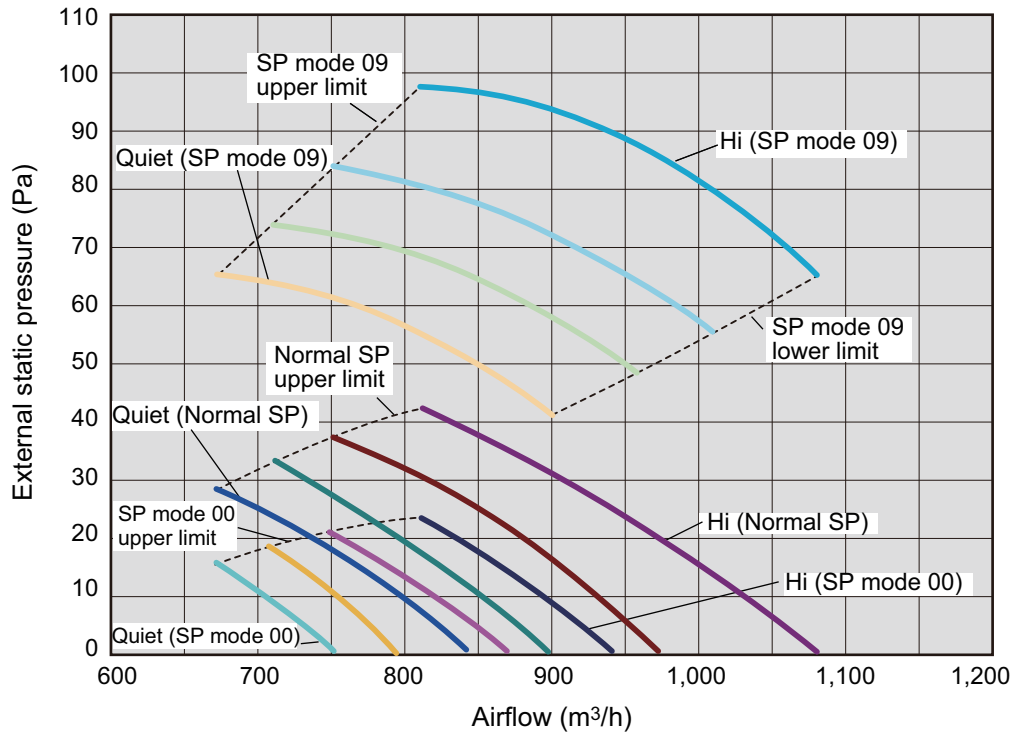

Available airflow rate range (High level)

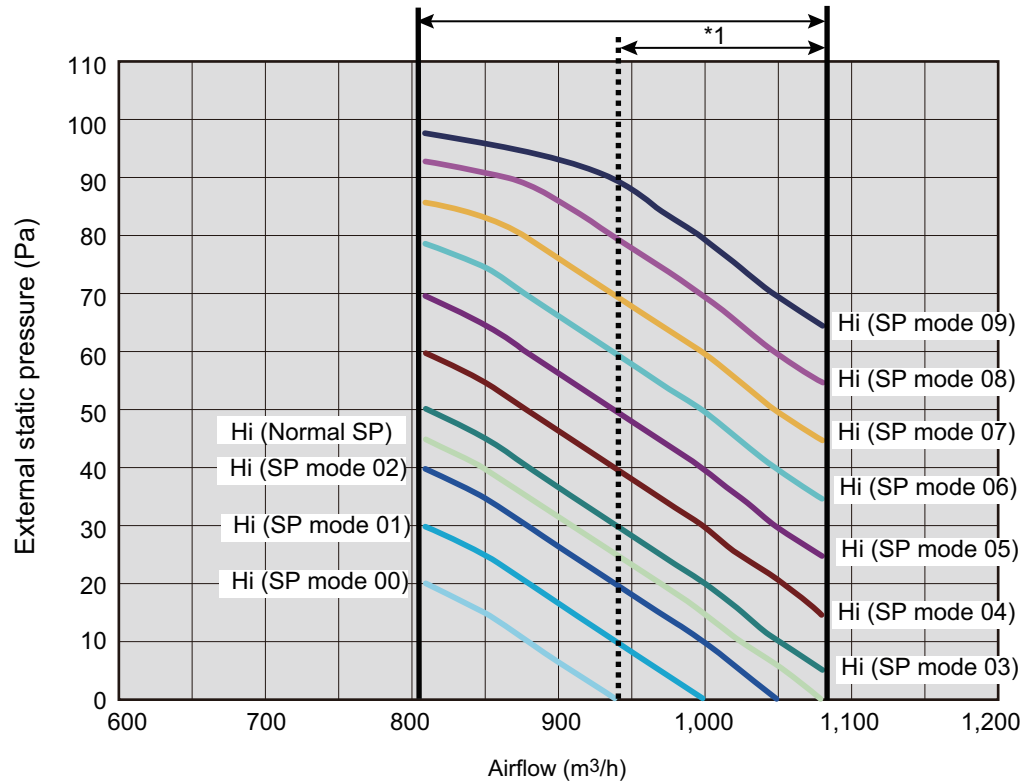

*1: Available airflow rate range when Auto louver grille (option) is installed.

Fan speed: HIGH

Vertical airflow direction louver: Up

● Characteristics of air volume and capacity

• Cooling

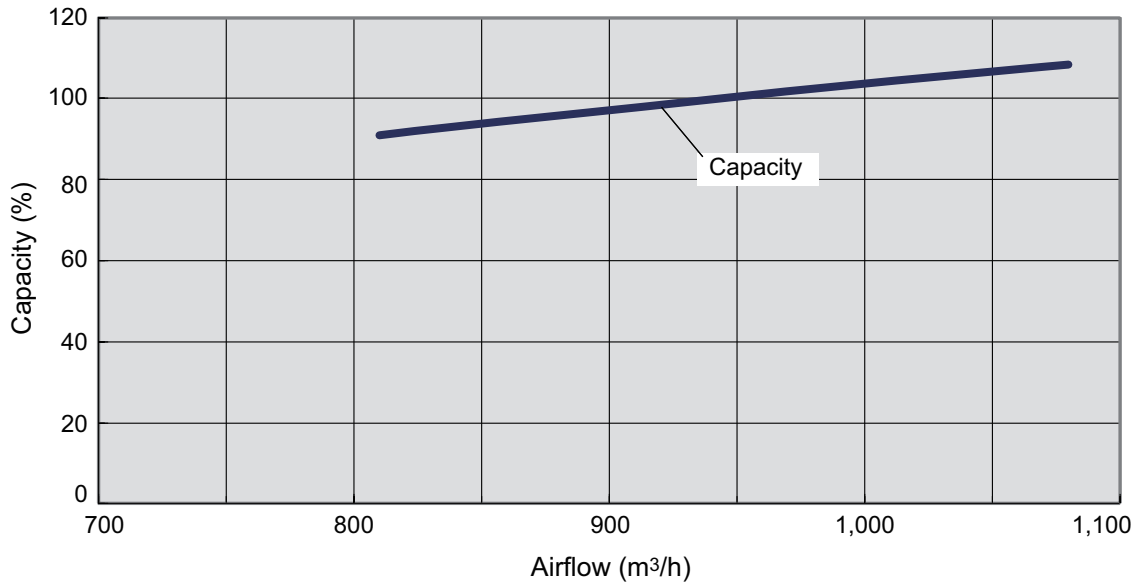

• Heating

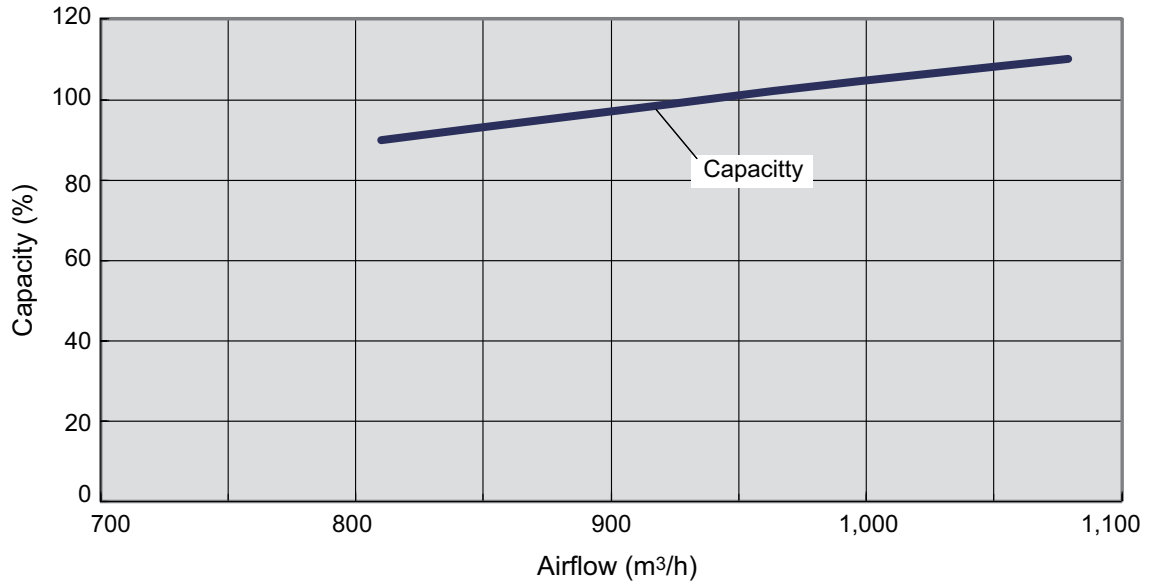

6-3. Medium static pressure duct type

■ Model: ARXG22KMLB (Normal mode)

Fan speed	Item	Static pressure (Pa)									
		6	8	11	14	18	21	25	30	35	40
HIGH	m ³ /h	—	—	—	—	—	—	—	1200	1100	1000
	l/s	—	—	—	—	—	—	—	333	306	278
	CFM	—	—	—	—	—	—	—	706	647	589
MED	m ³ /h	—	—	—	—	—	980	910	830	—	—
	l/s	—	—	—	—	—	272	253	231	—	—
	CFM	—	—	—	—	—	577	536	489	—	—
LOW	m ³ /h	—	—	—	825	750	690	—	—	—	—
	l/s	—	—	—	229	208	192	—	—	—	—
	CFM	—	—	—	486	441	406	—	—	—	—
QUIET	m ³ /h	630	580	525	—	—	—	—	—	—	—
	l/s	175	161	146	—	—	—	—	—	—	—
	CFM	371	341	309	—	—	—	—	—	—	—

Q-h Characteristic curve

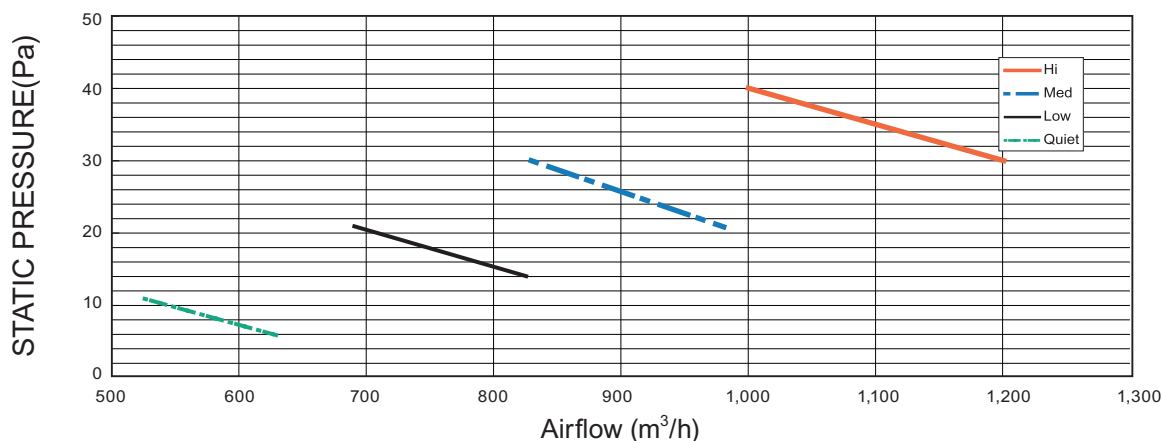

COOLING

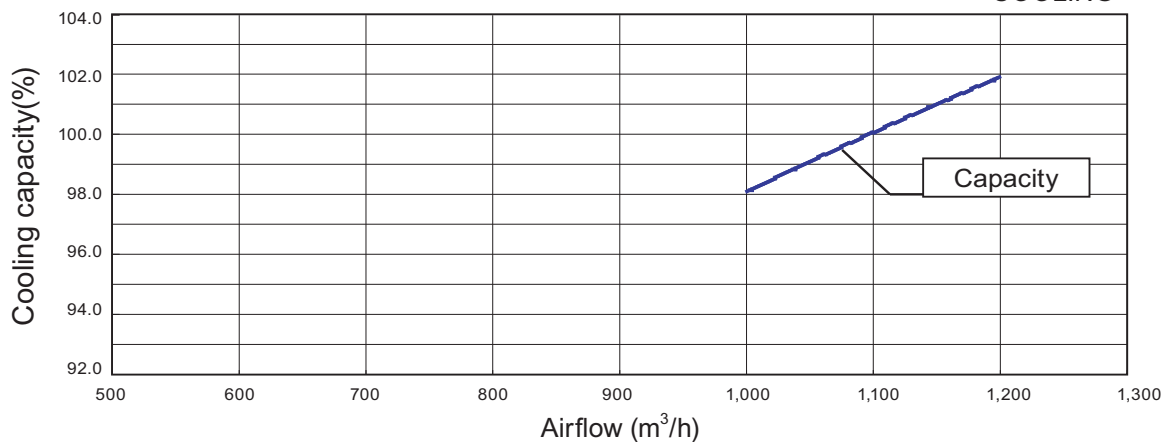

HEATING

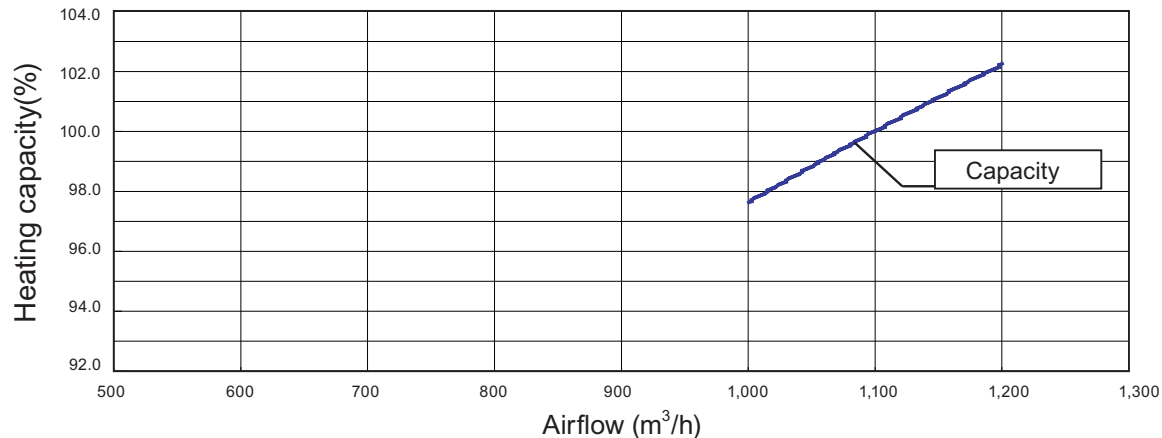

Model: ARXG22KMLB (Static pressure mode 1)

Fan speed	Item	Static pressure (Pa)							
		20	23	30	35	40	47	55	65
HIGH	m ³ /h	—	—	—	—	—	—	1200	1000
	l/s	—	—	—	—	—	—	333	278
	CFM	—	—	—	—	—	—	706	589
MED	m ³ /h	—	—	—	—	1000	815	—	—
	l/s	—	—	—	—	278	226	—	—
	CFM	—	—	—	—	589	480	—	—
LOW	m ³ /h	—	—	830	680	—	—	—	—
	l/s	—	—	231	189	—	—	—	—
	CFM	—	—	489	400	—	—	—	—
QUIET	m ³ /h	650	540	—	—	—	—	—	—
	l/s	181	150	—	—	—	—	—	—
	CFM	383	318	—	—	—	—	—	—

Q-h Characteristic curve

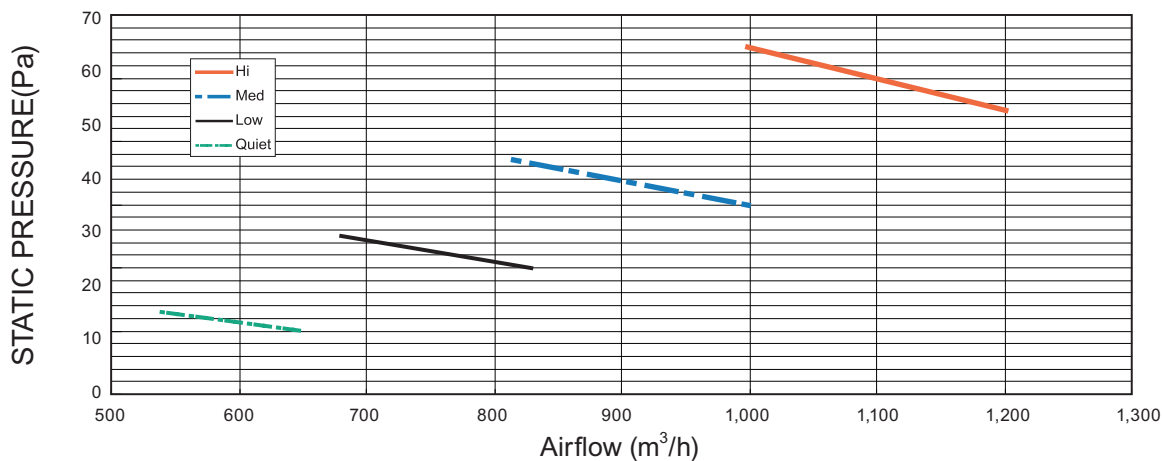

COOLING

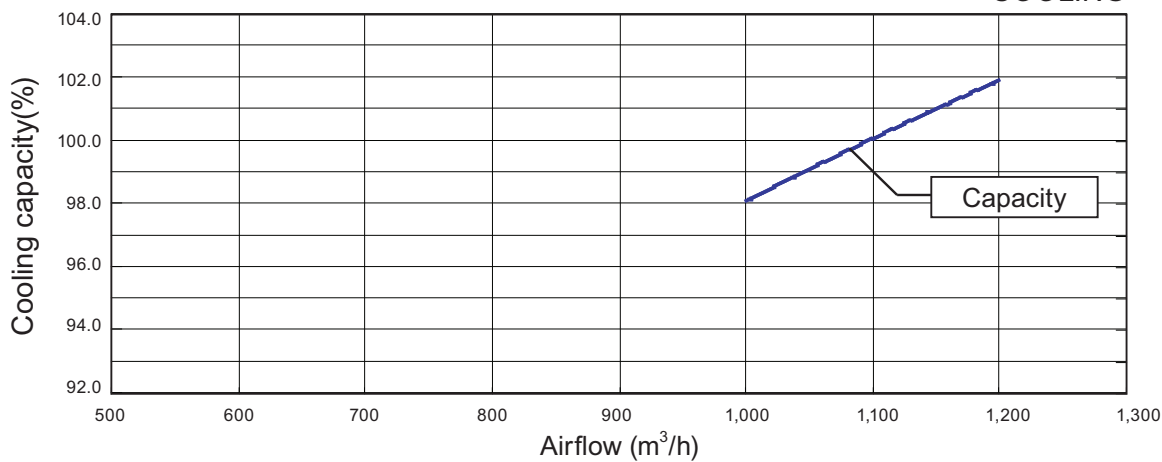

HEATING

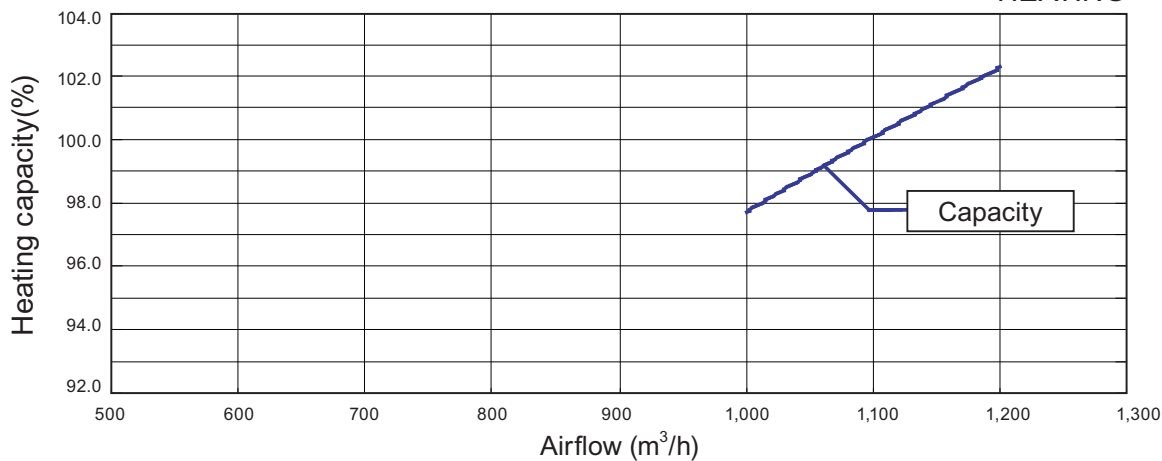

Model: ARXG22KMLB (Static pressure mode 2)

Fan speed	Item	Static pressure (Pa)							
		35	37	50	55	68	75	93	100
HIGH	m ³ /h	—	—	—	—	—	—	1160	930
	l/s	—	—	—	—	—	—	322	258
	CFM	—	—	—	—	—	—	683	547
MED	m ³ /h	—	—	—	—	1020	800	—	—
	l/s	—	—	—	—	283	222	—	—
	CFM	—	—	—	—	600	471	—	—
LOW	m ³ /h	—	—	835	670	—	—	—	—
	l/s	—	—	232	186	—	—	—	—
	CFM	—	—	491	394	—	—	—	—
QUIET	m ³ /h	660	530	—	—	—	—	—	—
	l/s	183	147	—	—	—	—	—	—
	CFM	388	312	—	—	—	—	—	—

Q-h Characteristic curve

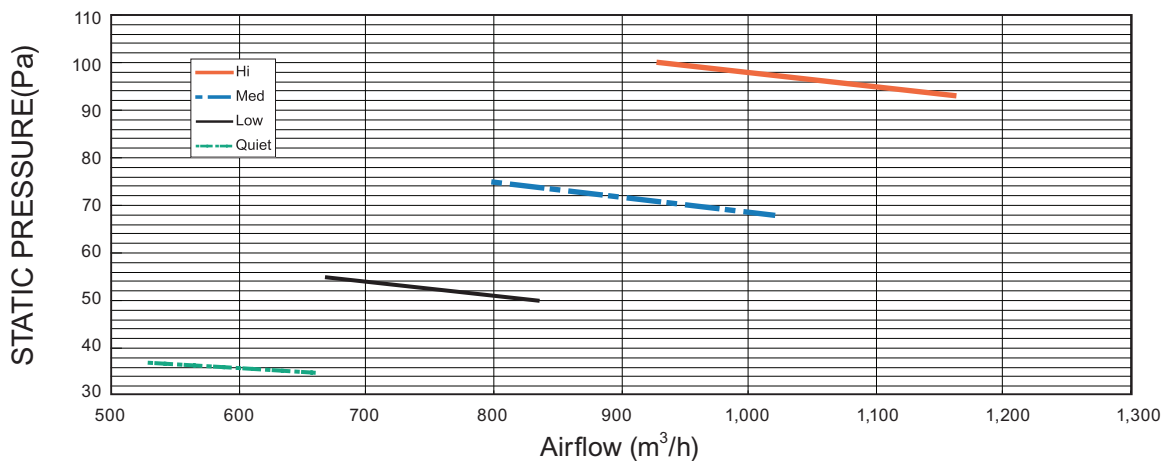

COOLING

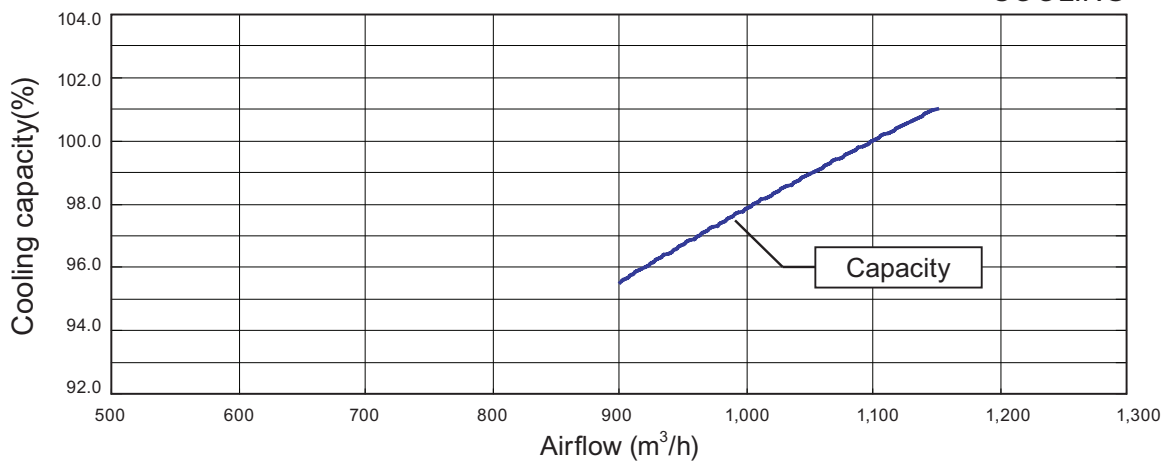

HEATING

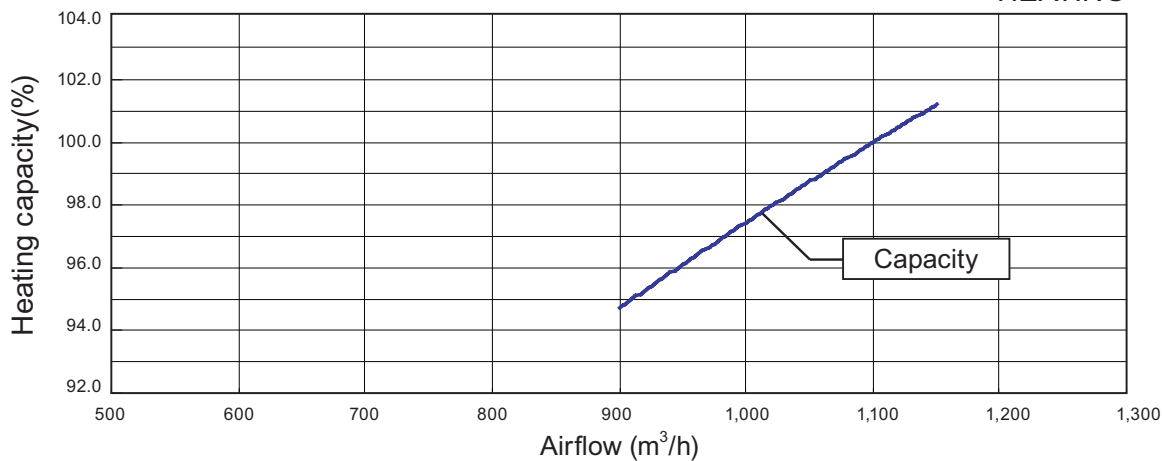

Model: ARXG22KMLB (Static pressure mode 3)

Fan speed	Item	Static pressure (Pa)							
		55	58	85	90	115	122	142	150
HIGH	m ³ /h	—	—	—	—	—	—	1100	880
	l/s	—	—	—	—	—	—	306	244
	CFM	—	—	—	—	—	—	647	518
MED	m ³ /h	—	—	—	—	1000	810	—	—
	l/s	—	—	—	—	278	225	—	—
	CFM	—	—	—	—	589	477	—	—
LOW	m ³ /h	—	—	840	680	—	—	—	—
	l/s	—	—	233	189	—	—	—	—
	CFM	—	—	494	400	—	—	—	—
QUIET	m ³ /h	660	525	—	—	—	—	—	—
	l/s	183	146	—	—	—	—	—	—
	CFM	388	309	—	—	—	—	—	—

Q-h Characteristic curve

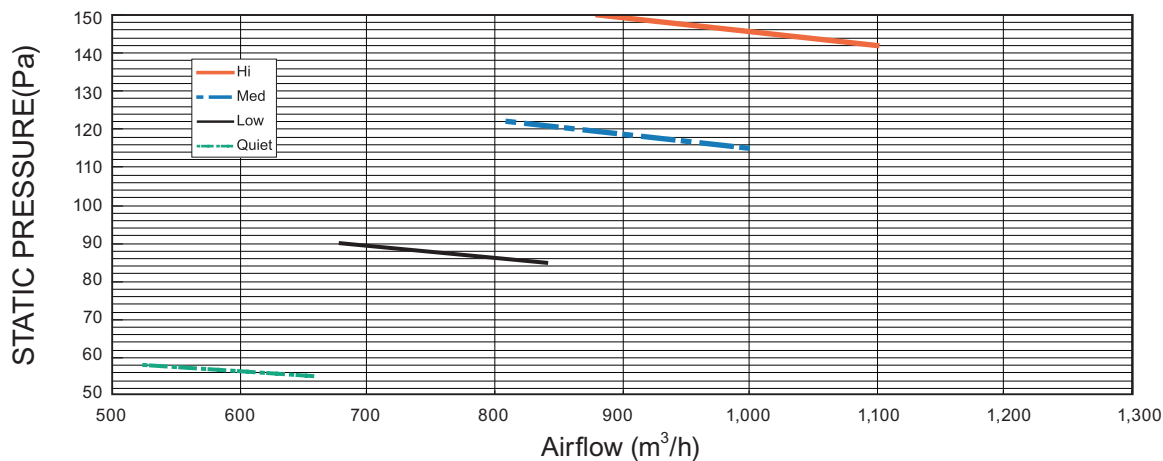

COOLING

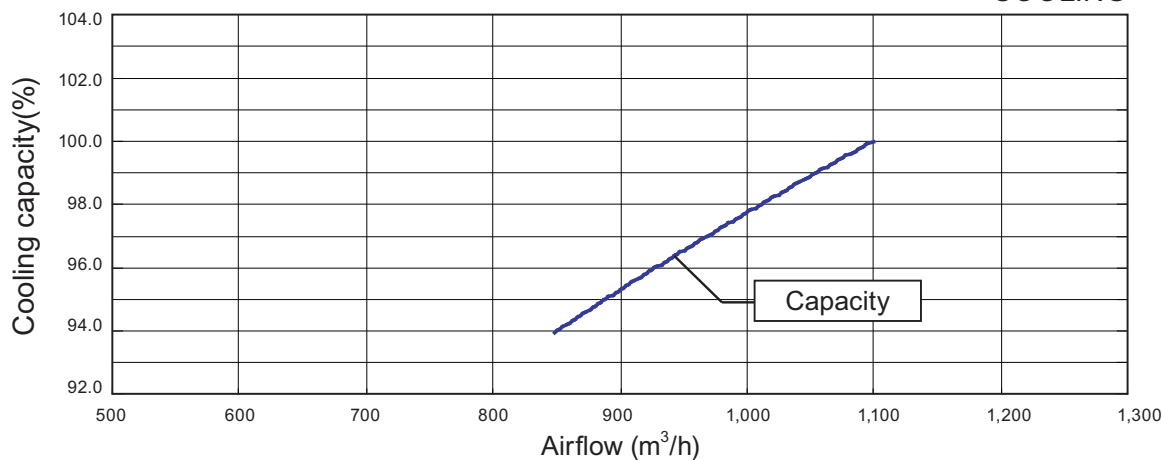

HEATING

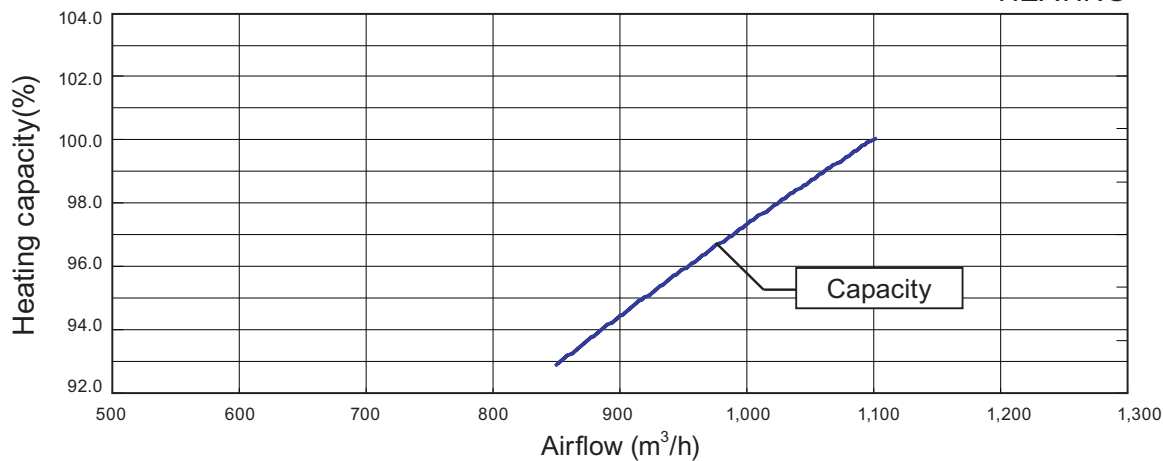

7. Airflow

Conversion factor:

- $1 \text{ m}^3/\text{h} = 0.2778 \text{ l/s} = 0.5886 \text{ CFM}$
- $3.6 \text{ m}^3/\text{h} = 1 \text{ l/s}$
- $1.699 \text{ m}^3/\text{h} = 1 \text{ CFM}$

7-1. Compact cassette type

Model	Operation mode	Fan speed	Airflow		
			m ³ /h	l/s	CFM
AUXG07KVLA AUXG09KVLA	Cooling	High	540	150	318
		Med	490	136	288
		Low	440	122	259
		Quiet	390	108	230
	Heating	High	540	150	318
		Med	490	136	288
		Low	440	122	259
		Quiet	390	108	230
AUXG12KVLA	Cooling	High	610	169	359
		Med	530	147	312
		Low	470	131	277
		Quiet	410	114	241
	Heating	High	610	169	359
		Med	530	147	312
		Low	470	131	277
		Quiet	410	114	241
AUXG14KVLA	Cooling	High	680	189	400
		Med	580	161	341
		Low	490	136	288
		Quiet	410	114	241
	Heating	High	790	219	465
		Med	680	189	400
		Low	580	161	341
		Quiet	450	125	265
AUXG18KVLA	Cooling	High	680	189	400
		Med	580	161	341
		Low	490	136	288
		Quiet	410	114	241
	Heating	High	790	219	465
		Med	680	189	400
		Low	580	161	341
		Quiet	450	125	265
AUXG22KVLA	Cooling	High	830	231	489
		Med	740	206	436
		Low	600	167	353
		Quiet	450	125	265
	Heating	High	860	239	506
		Med	760	211	447
		Low	700	194	412
		Quiet	530	147	312

7-2. Mini duct type

Model	Operation mode	Fan speed	Airflow		
			m ³ /h	l/s	CFM
ARXG07KSLAP	Cooling	High	550	153	324
		Med	440	122	259
		Low	390	108	230
		Quiet	360	100	212
	Heating	High	550	153	324
		Med	550	122	259
		Low	390	108	230
		Quiet	360	100	212
ARXG09KSLAP	Cooling	High	600	167	353
		Med	450	125	265
		Low	400	111	235
		Quiet	360	100	212
	Heating	High	600	167	353
		Med	450	125	265
		Low	400	111	235
		Quiet	360	100	212
ARXG12KSLAP	Cooling	High	650	181	383
		Med	490	136	288
		Low	430	119	253
		Quiet	360	100	212
	Heating	High	650	181	383
		Med	490	136	288
		Low	430	119	253
		Quiet	360	100	212
ARXG14KSLAP	Cooling	High	800	222	471
		Med	640	178	377
		Low	530	147	312
		Quiet	360	100	212
	Heating	High	800	222	471
		Med	640	178	377
		Low	530	147	312
		Quiet	360	100	212
ARXG18KSLAP	Cooling	High	940	261	553
		Med	750	208	441
		Low	540	150	318
		Quiet	480	133	283
	Heating	High	940	261	553
		Med	750	208	441
		Low	540	150	318
		Quiet	480	133	283

7-3. Slim duct type

Model	Operation mode	Fan speed	Airflow		
			m ³ /h	l/s	CFM
ARXG07KLLAP	Cooling	High	550	153	324
		Med	490	136	288
		Low	470	131	277
		Quiet	440	122	259
	Heating	High	550	153	324
		Med	490	136	288
		Low	470	131	277
		Quiet	440	122	259
ARXG09KLLAP	Cooling	High	600	167	353
		Med	550	153	324
		Low	500	139	294
		Quiet	450	125	265
	Heating	High	600	167	353
		Med	550	153	324
		Low	500	139	294
		Quiet	450	125	265
ARXG12KLLAP	Cooling	High	650	181	383
		Med	600	167	353
		Low	550	153	324
		Quiet	480	133	283
	Heating	High	650	181	383
		Med	600	167	353
		Low	550	153	324
		Quiet	480	133	283
ARXG14KLLAP	Cooling	High	800	222	471
		Med	700	194	412
		Low	600	167	353
		Quiet	480	133	283
	Heating	High	800	222	471
		Med	700	194	412
		Low	600	167	353
		Quiet	480	133	283
ARXG18KLLAP	Cooling	High	940	261	553
		Med	880	244	518
		Low	820	228	483
		Quiet	750	208	441
	Heating	High	940	261	553
		Med	880	244	518
		Low	820	228	483
		Quiet	750	208	441

7-4. Medium static pressure duct type

Model	Operation mode	Fan speed	Airflow		
			m ³ /h	l/s	CFM
ARXG22KMLB	Cooling	High	1,100	306	647
		Med	910	253	536
		Low	750	208	441
		Quiet	580	161	341
	Heating	High	1,100	306	647
		Med	910	253	536
		Low	750	208	441
		Quiet	580	161	341

7-5. Wall mounted type

Model	Operation mode	Fan speed	Airflow		
			m ³ /h	l/s	CFM
ASYG07KGTB	Cooling	High	650	181	383
		Med	540	150	318
		Low	430	119	253
		Quiet	270	75	159
	Heating	High	720	200	424
		Med	580	161	341
		Low	460	128	271
		Quiet	330	92	194
ASYG09KGTB	Cooling	High	700	194	412
		Med	560	156	330
		Low	430	119	253
		Quiet	270	75	159
	Heating	High	750	208	441
		Med	610	169	359
		Low	470	131	277
		Quiet	330	92	194
ASYG12KGTB	Cooling	High	700	194	412
		Med	560	156	330
		Low	430	119	253
		Quiet	270	75	159
	Heating	High	770	214	453
		Med	640	178	377
		Low	520	144	306
		Quiet	330	92	194
ASYG14KGTB	Cooling	High	770	214	453
		Med	600	167	353
		Low	450	125	265
		Quiet	280	78	165
	Heating	High	800	222	471
		Med	660	183	388
		Low	520	144	306
		Quiet	340	94	200
ASYG18KMTB	Cooling	High	980	272	577
		Med	810	225	477
		Low	640	178	377
		Quiet	510	142	300
	Heating	High	1,020	283	600
		Med	850	236	500
		Low	640	178	377
		Quiet	510	142	300
ASYG22KMTB	Cooling	High	1,060	294	624
		Med	810	225	477
		Low	640	178	377
		Quiet	510	142	300
	Heating	High	1,060	294	624
		Med	850	236	500
		Low	640	178	377
		Quiet	510	142	300

Model	Operation mode	Fan speed	Airflow		
			m ³ /h	l/s	CFM
ASYG24KMTB	Cooling	High	1,170	325	689
		Med	850	236	500
		Low	640	178	377
		Quiet	510	142	300
	Heating	High	1,170	325	689
		Med	850	236	500
		Low	640	178	377
		Quiet	510	142	300
ASYG07KMTB	Cooling	High	650	181	383
		Med	540	150	318
		Low	430	119	253
		Quiet	270	75	159
	Heating	High	720	200	424
		Med	580	161	341
		Low	460	128	271
		Quiet	330	92	194
ASYG09KMTB	Cooling	High	700	194	412
		Med	560	156	330
		Low	430	119	253
		Quiet	270	75	159
	Heating	High	750	208	441
		Med	610	169	359
		Low	470	131	277
		Quiet	330	92	194
ASYG12KMTB	Cooling	High	700	194	412
		Med	560	156	330
		Low	430	119	253
		Quiet	270	75	159
	Heating	High	770	214	453
		Med	640	178	377
		Low	520	144	306
		Quiet	330	92	194
ASYG14KMTB	Cooling	High	770	214	453
		Med	600	167	353
		Low	450	125	265
		Quiet	280	78	165
	Heating	High	800	222	471
		Med	660	183	388
		Low	520	144	306
		Quiet	340	94	200
ASYG07KMCC	Cooling	High	650	181	383
		Med	540	150	318
		Low	430	119	253
		Quiet	320	89	188
	Heating	High	720	200	424
		Med	580	161	341
		Low	460	128	271
		Quiet	330	92	194

Model	Operation mode	Fan speed	Airflow		
			m ³ /h	l/s	CFM
ASYG09KMCC	Cooling	High	700	194	412
		Med	560	156	330
		Low	430	119	253
		Quiet	320	89	188
	Heating	High	750	208	441
		Med	610	169	359
		Low	470	131	277
		Quiet	330	92	194
ASYG12KMCC	Cooling	High	700	194	412
		Med	560	156	330
		Low	430	119	253
		Quiet	320	89	188
	Heating	High	780	217	459
		Med	640	178	377
		Low	520	144	306
		Quiet	330	92	194
ASYG14KMCC	Cooling	High	770	214	453
		Med	600	167	353
		Low	450	125	265
		Quiet	310	86	182
	Heating	High	820	228	483
		Med	660	183	388
		Low	520	144	306
		Quiet	340	94	200
ASYG07KETA ASYG07KETA-B	Cooling	High	650	181	383
		Med	540	150	318
		Low	430	119	253
		Quiet	270	75	159
	Heating	High	720	200	424
		Med	580	161	341
		Low	460	128	271
		Quiet	330	92	194
ASYG09KETA ASYG09KETA-B	Cooling	High	700	194	412
		Med	560	156	330
		Low	430	119	253
		Quiet	270	75	159
	Heating	High	750	208	441
		Med	610	169	359
		Low	470	131	277
		Quiet	330	92	194
ASYG12KETA ASYG12KETA-B	Cooling	High	700	194	412
		Med	560	156	330
		Low	430	119	253
		Quiet	270	75	159
	Heating	High	770	214	453
		Med	640	178	377
		Low	520	144	306
		Quiet	330	92	194

Model	Operation mode	Fan speed	Airflow		
			m ³ /h	l/s	CFM
ASYG14KETA ASYG14KETA-B	Cooling	High	770	214	453
		Med	600	167	353
		Low	450	125	265
		Quiet	280	78	165
	Heating	High	800	222	471
		Med	660	183	388
		Low	520	144	306
		Quiet	340	94	200

7-6. Ceiling type

Model	Operation mode	Fan speed	Airflow		
			m ³ /h	l/s	CFM
ABYG18KRTA	Cooling	High	840	233	494
		Med	790	219	465
		Low	710	197	418
		Quiet	650	181	383
	Heating	High	840	233	494
		Med	790	219	465
		Low	710	197	418
		Quiet	650	181	383
ABYG22KRTA	Cooling	High	900	250	530
		Med	790	219	465
		Low	710	197	418
		Quiet	650	181	383
	Heating	High	900	250	530
		Med	790	219	465
		Low	710	197	418
		Quiet	650	181	383

7-7. Floor type

Model	Operation mode	Fan speed	Airflow		
			m ³ /h	l/s	CFM
AGYG09KVCA	Cooling	High	530	147	312
		Med	440	111	235
		Low	360	100	212
		Quiet	270	75	159
	Heating	High	530	147	312
		Med	460	128	271
		Low	380	106	224
		Quiet	270	75	159
AGYG12KVCA	Cooling	High	600	167	353
		Med	490	136	288
		Low	380	106	224
		Quiet	270	75	159
	Heating	High	600	167	353
		Med	510	142	300
		Low	410	114	241
		Quiet	270	75	159
AGYG14KVCA	Cooling	High	650	181	383
		Med	520	144	306
		Low	400	131	277
		Quiet	270	75	159
	Heating	High	650	181	383
		Med	540	150	318
		Low	430	119	253
		Quiet	270	75	159

8. Noise level curve

8-1. Compact cassette type

Model: AUXG07KVLA

Cooling

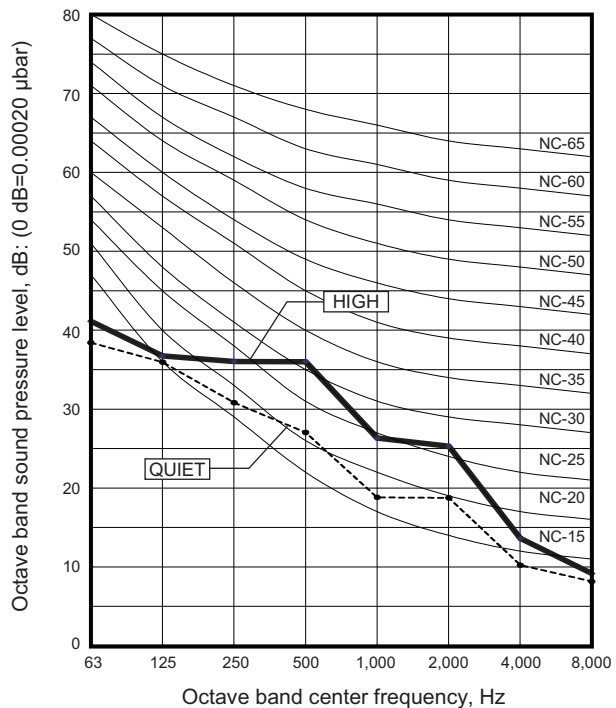

Heating

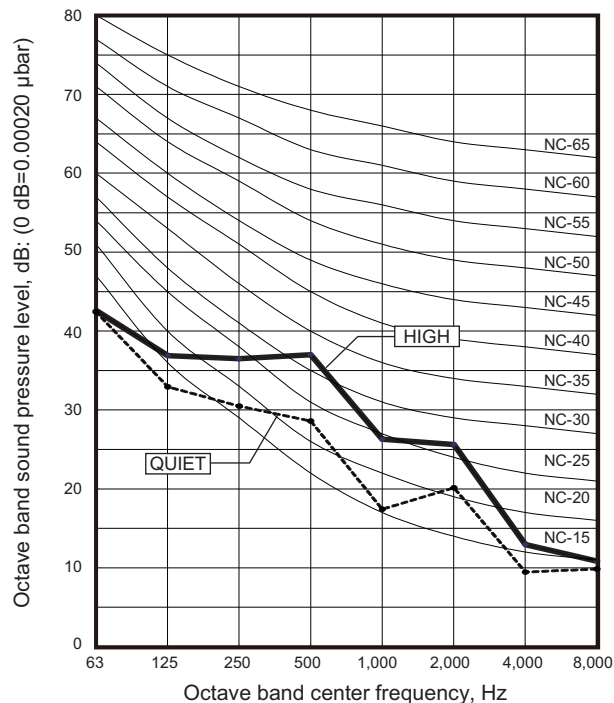

Model: AUXG09KVLA

Cooling

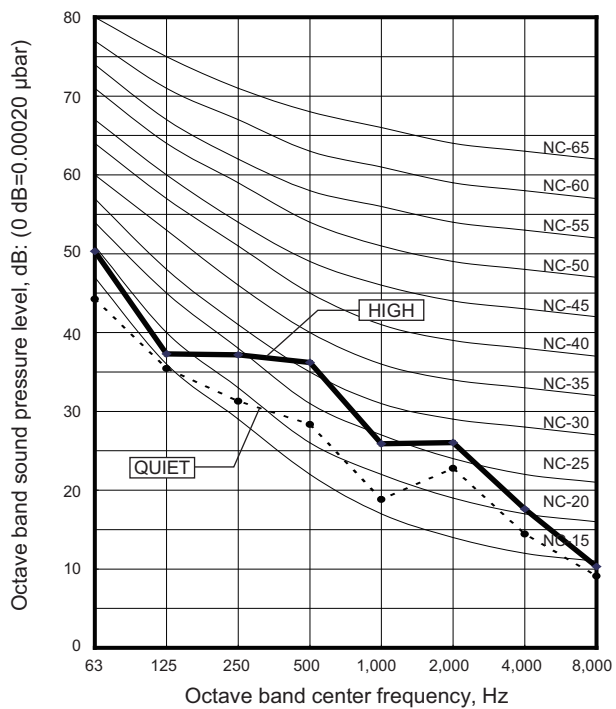

Heating

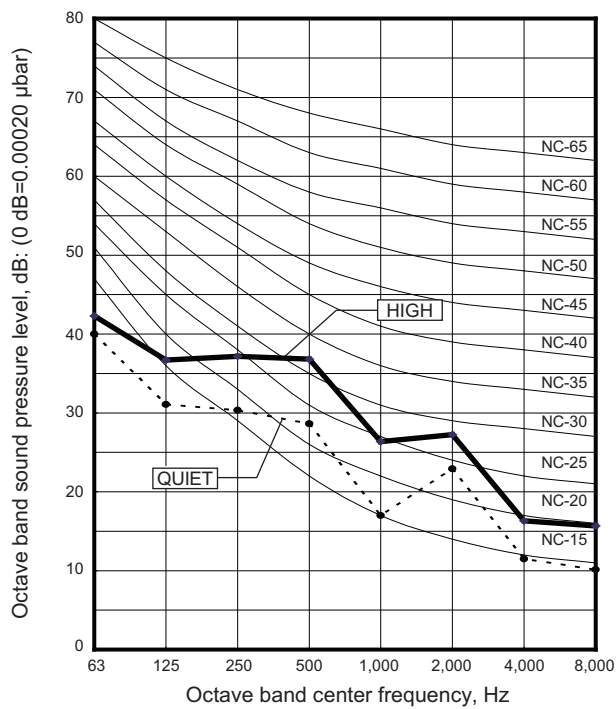

Model: AUXG12KVLA

Cooling

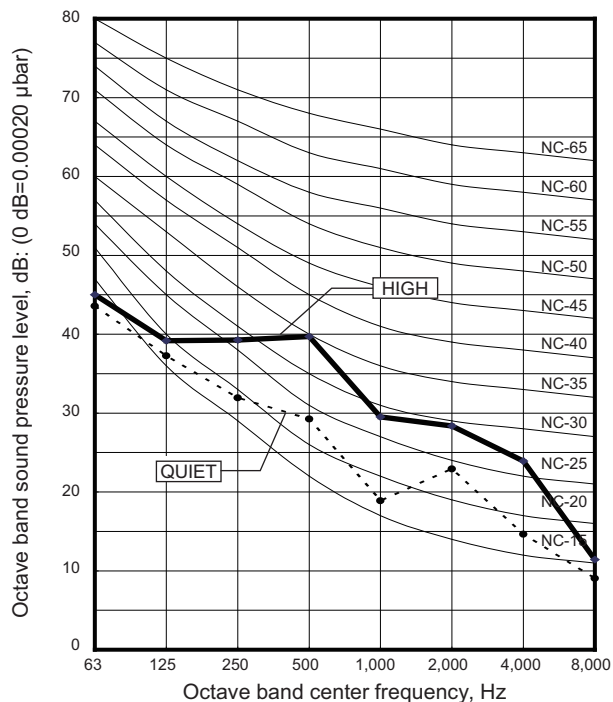

Heating

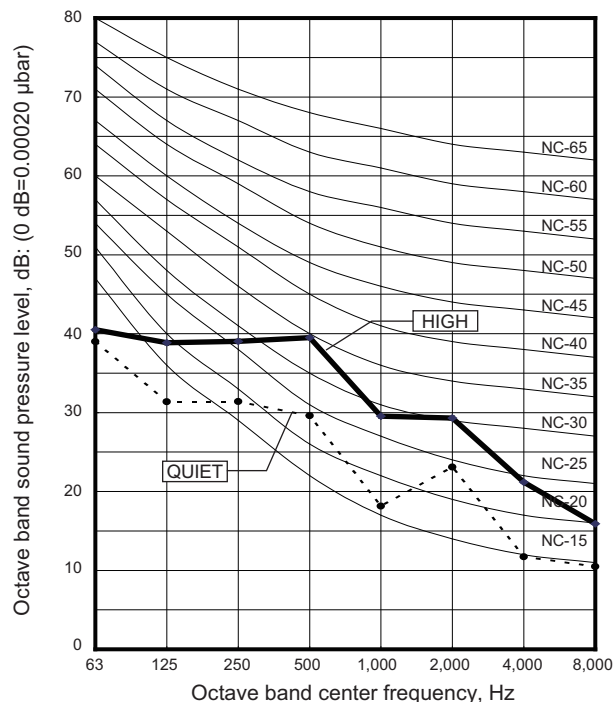

Model: AUXG14KVLA

Cooling

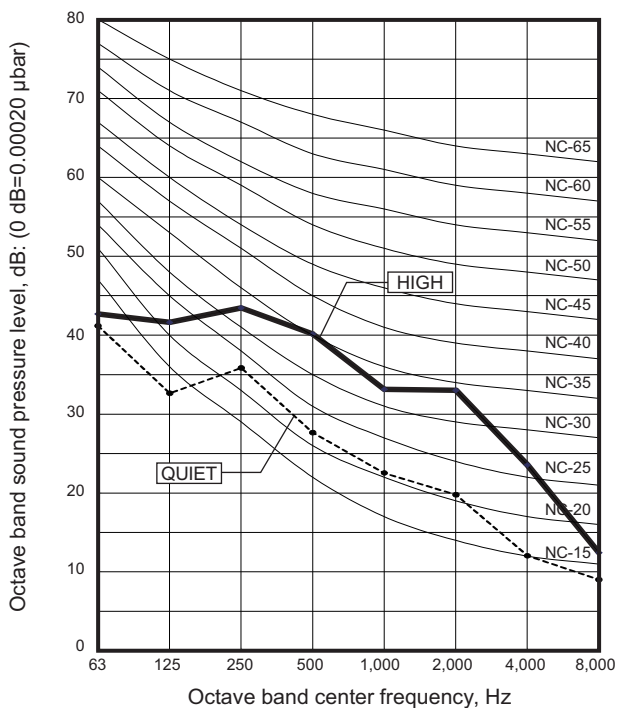

Heating

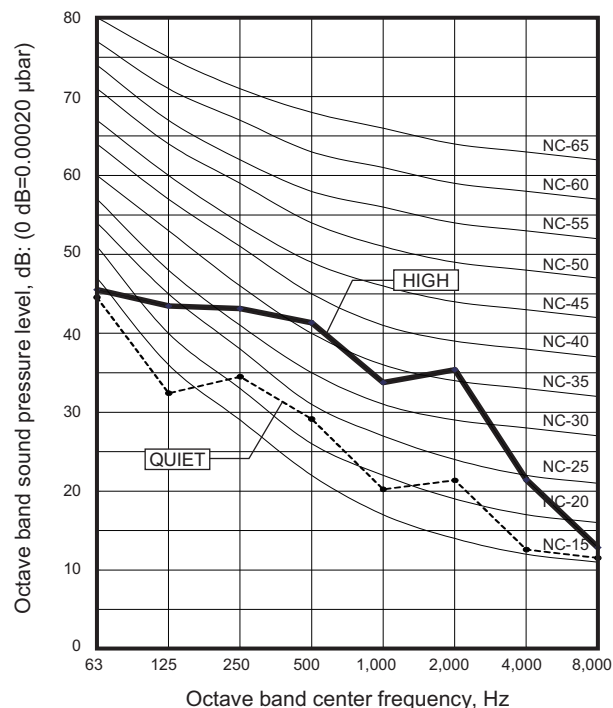

Model: AUXG18KVLA

Cooling

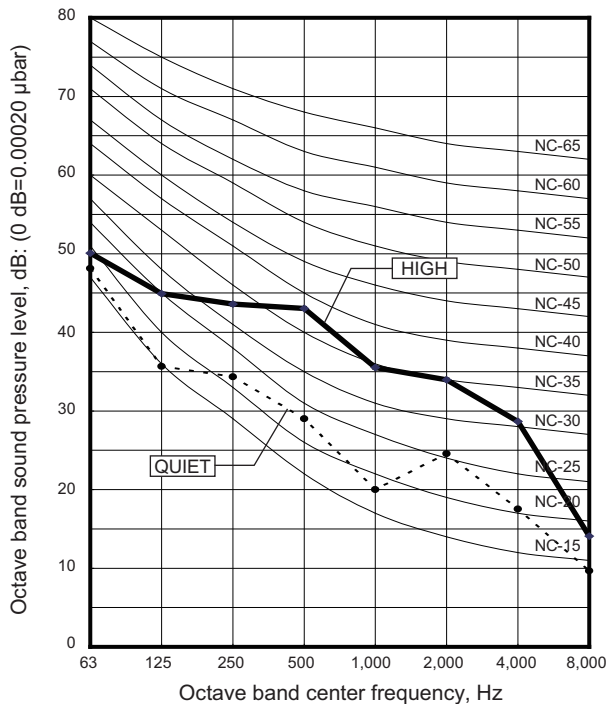

Heating

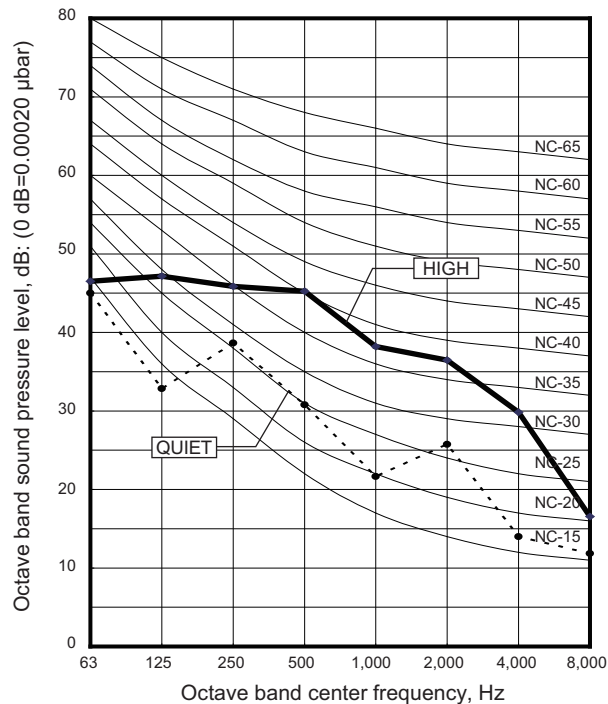

Model: AUXG22KVLA

Cooling

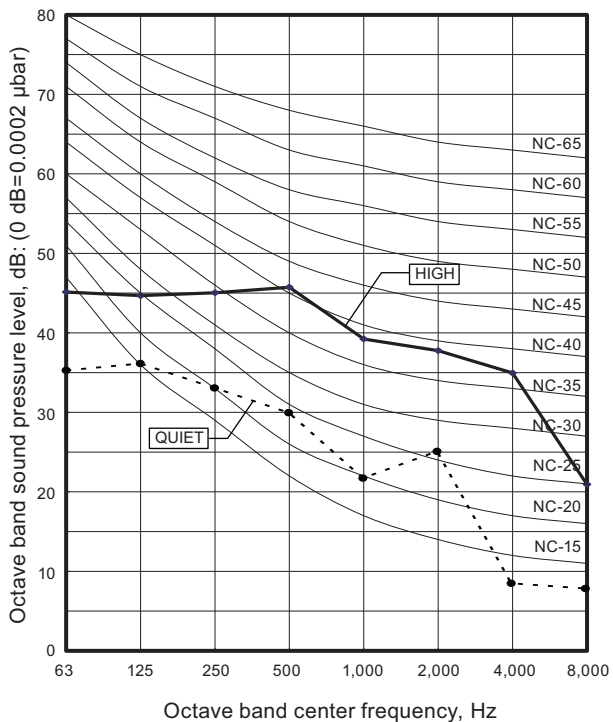

Heating

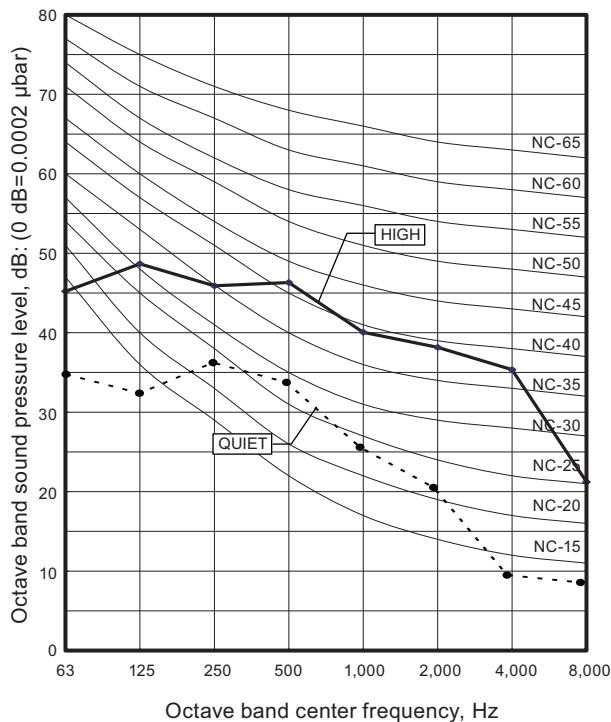

8-2. Mini duct type

Model: ARXG07KSLAP

● Cooling

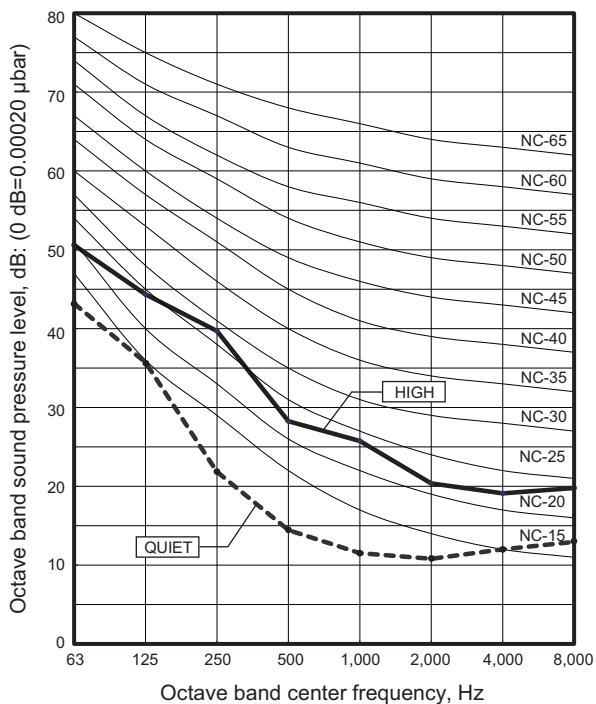

● Heating

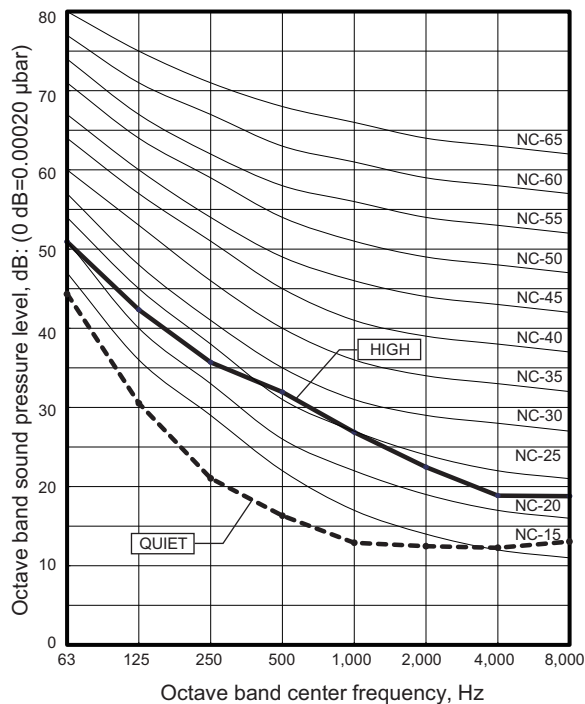

Model: ARXG09KSLAP

● Cooling

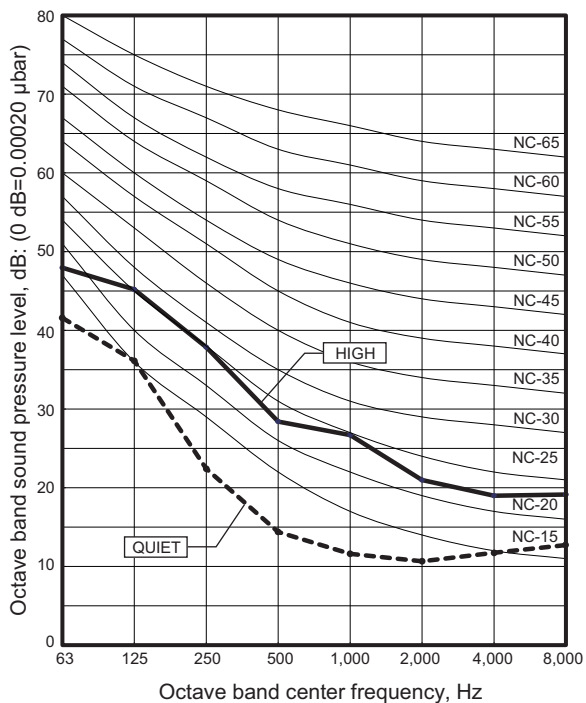

● Heating

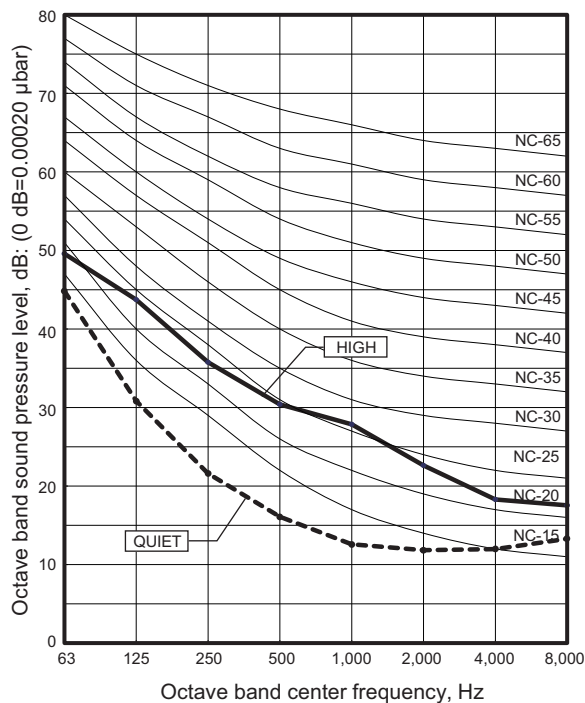

Model: ARXG12KSLAP

Cooling

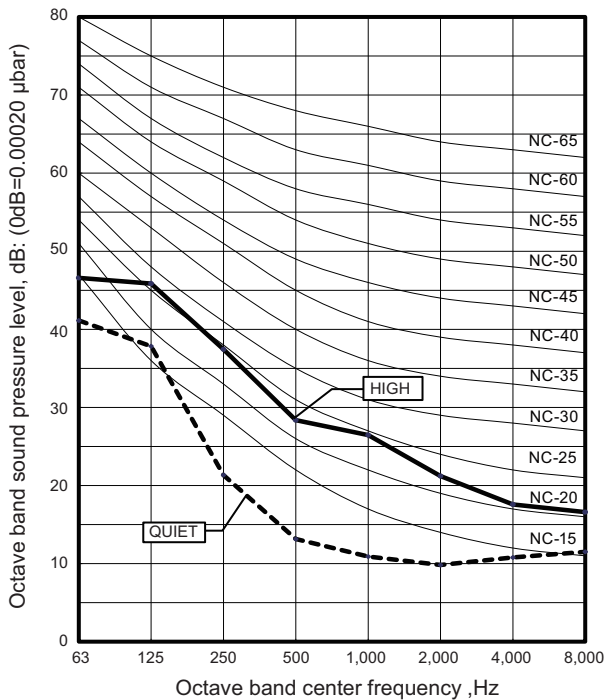

Heating

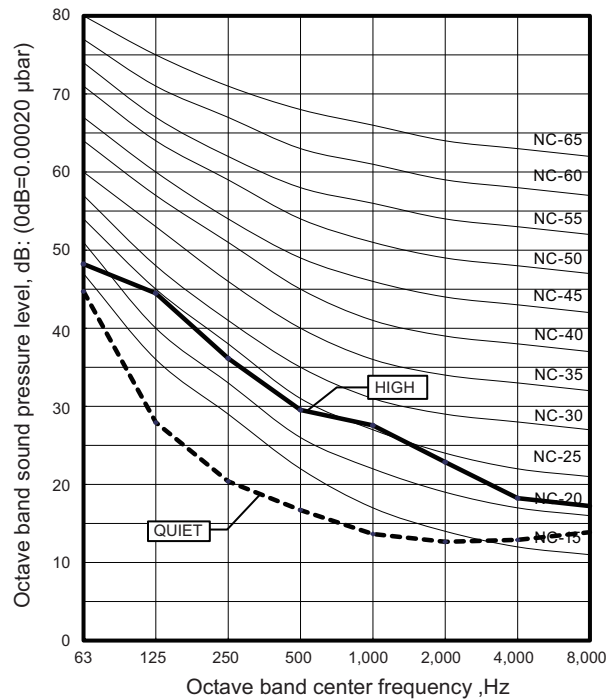

Model: ARXG14KSLAP

Cooling

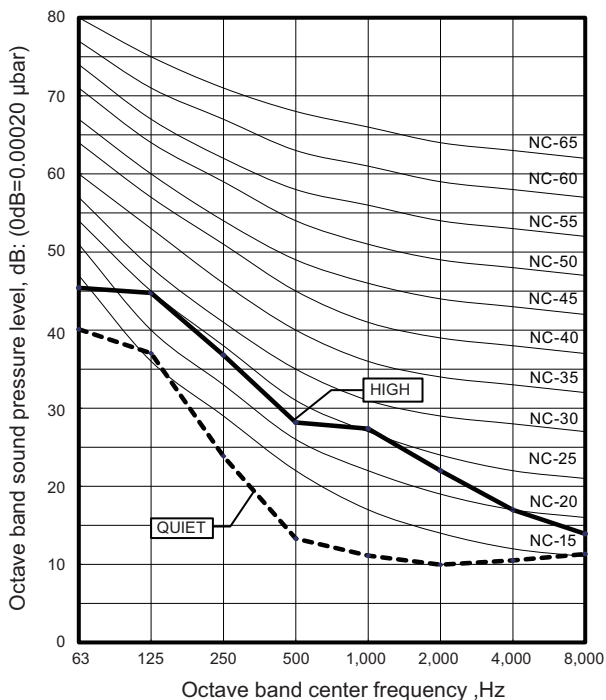

Heating

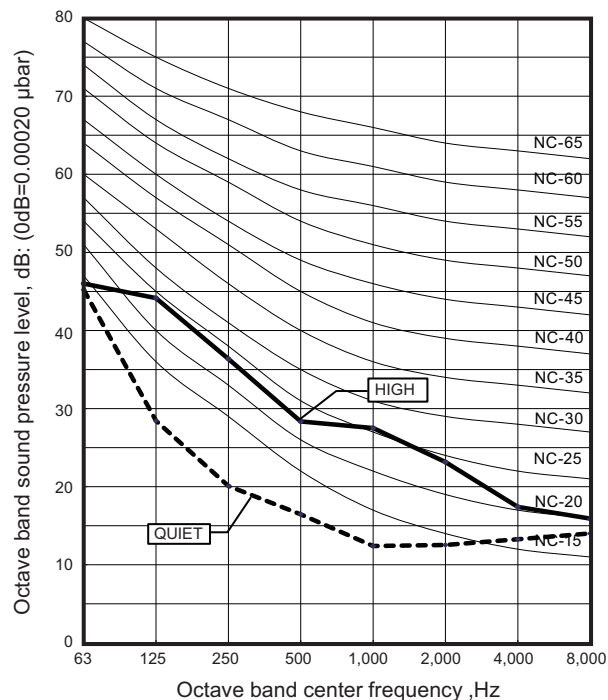

■ Model: ARXG18KSLAP

● Cooling

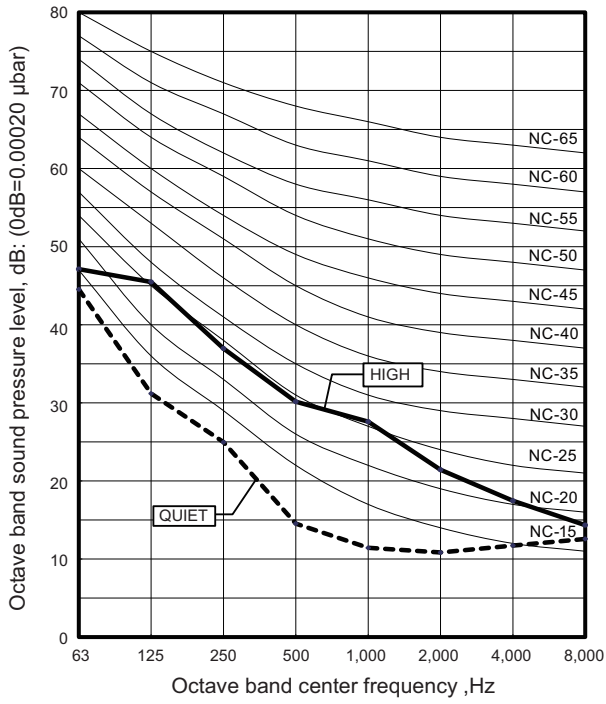

● Heating

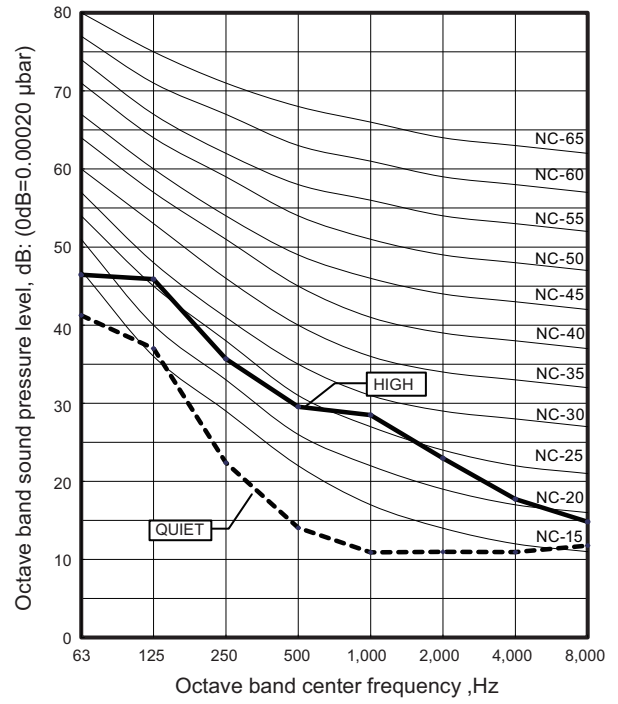

8-3. Slim duct type

Model: ARXG07KLLAP

● Cooling

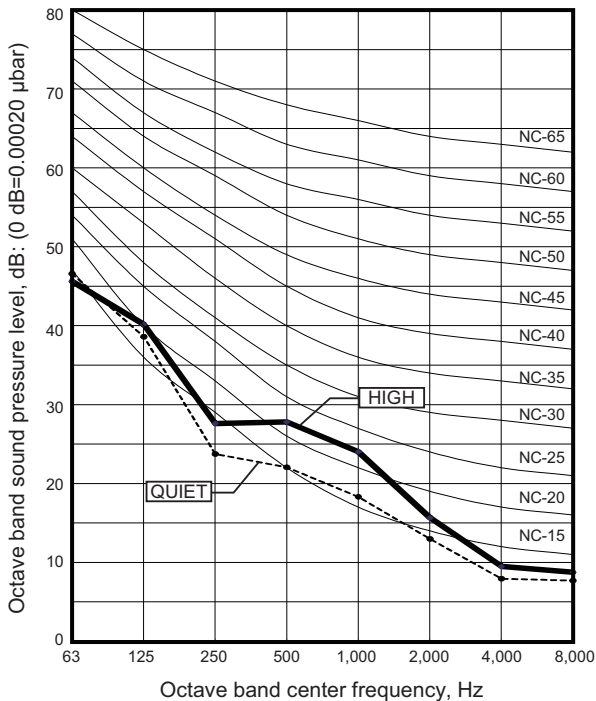

● Heating

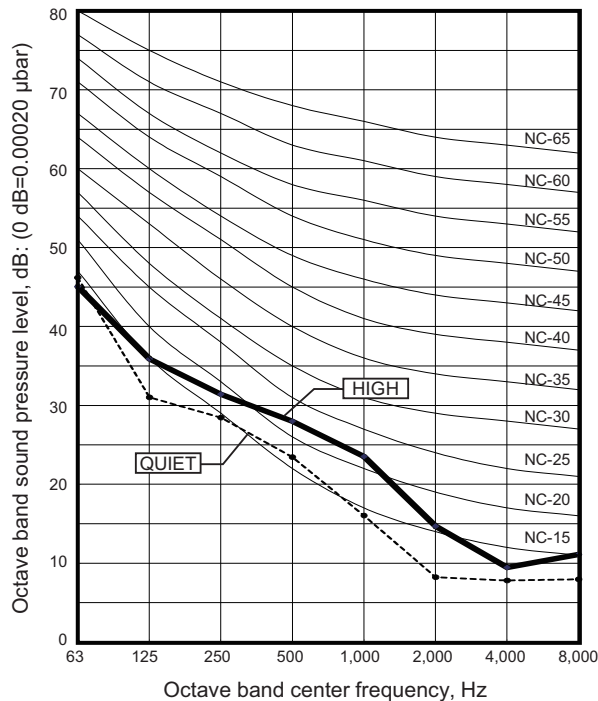

Model: ARXG09KLLAP

● Cooling

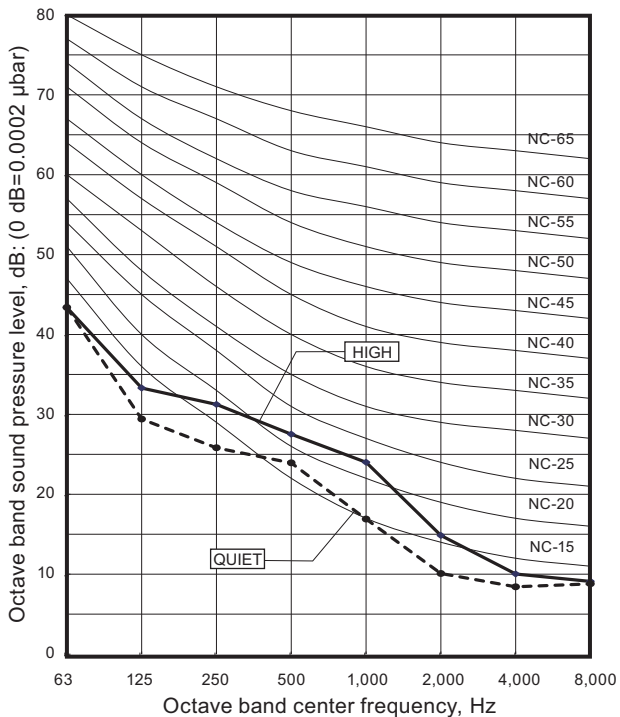

● Heating

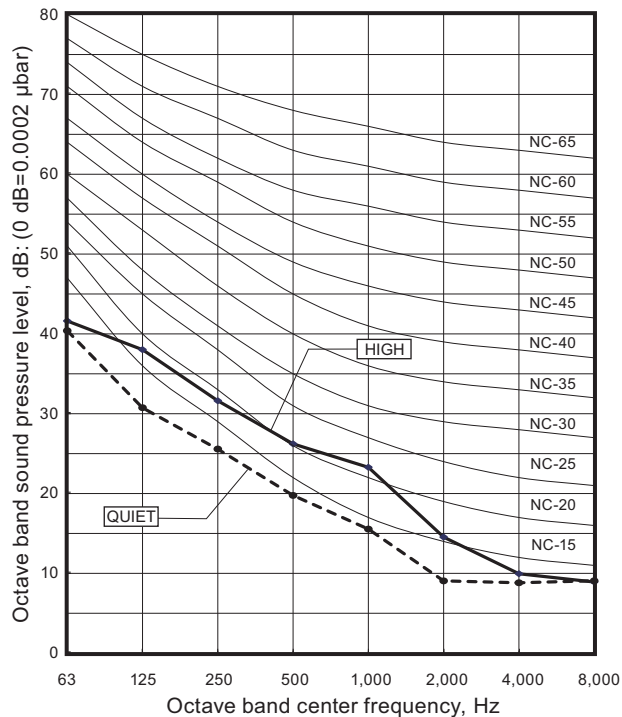

Model: ARXG12KLLAP

Cooling

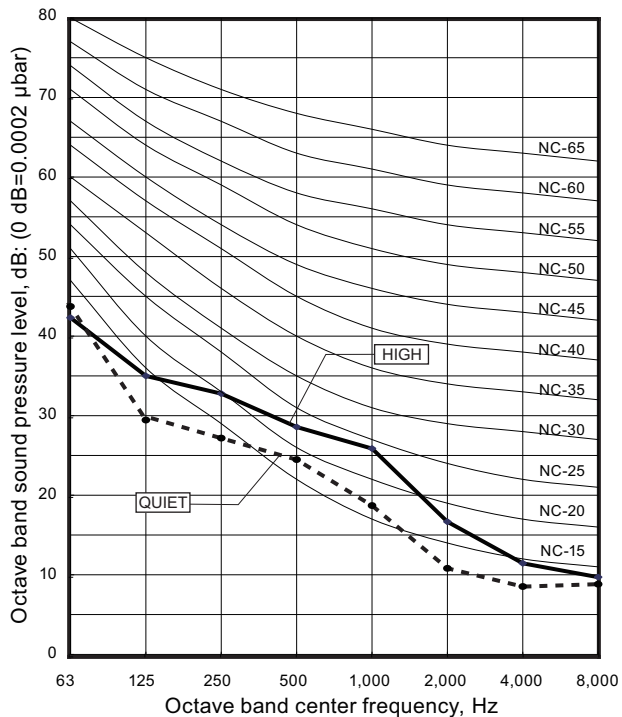

Heating

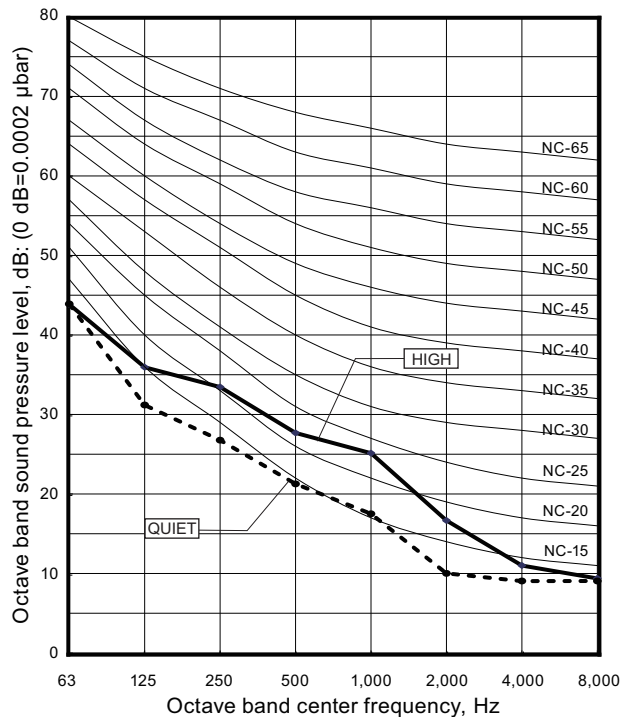

Model: ARXG14KLLAP

Cooling

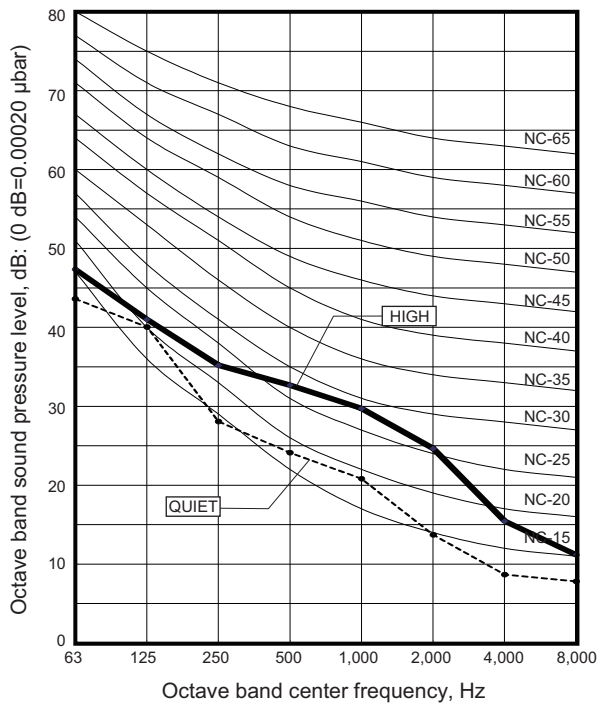

Heating

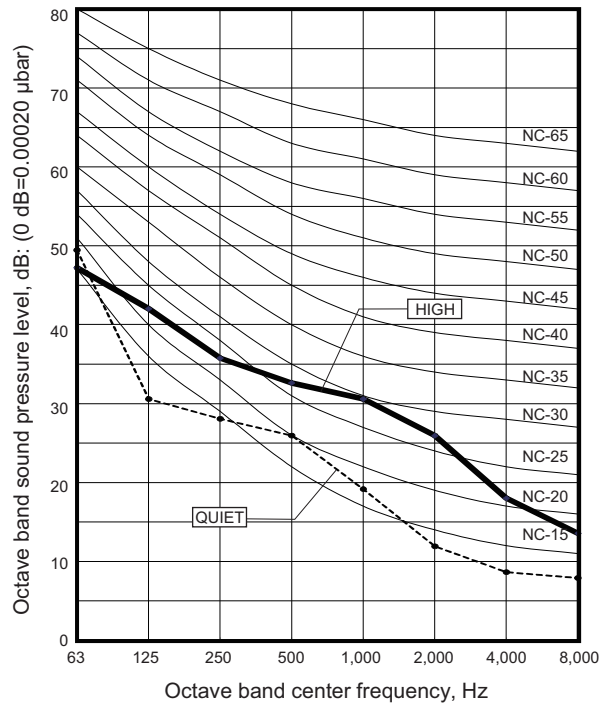

■ Model: ARXG18KLLAP

● Cooling

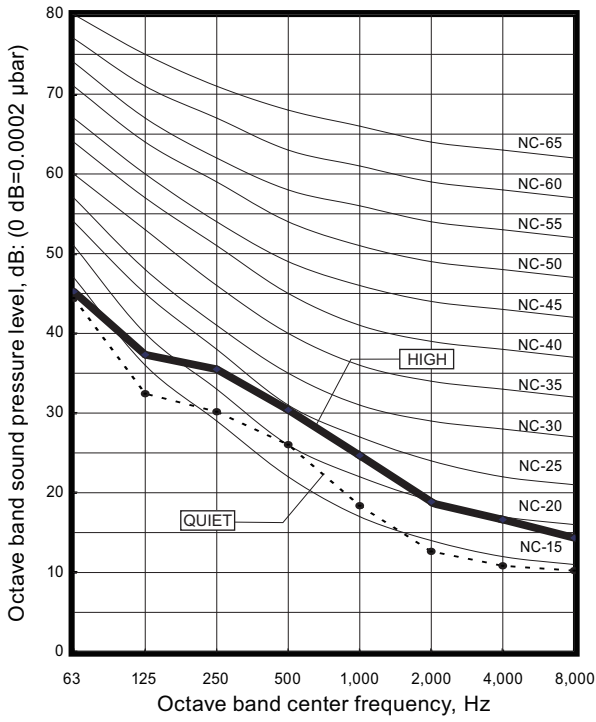

● Heating

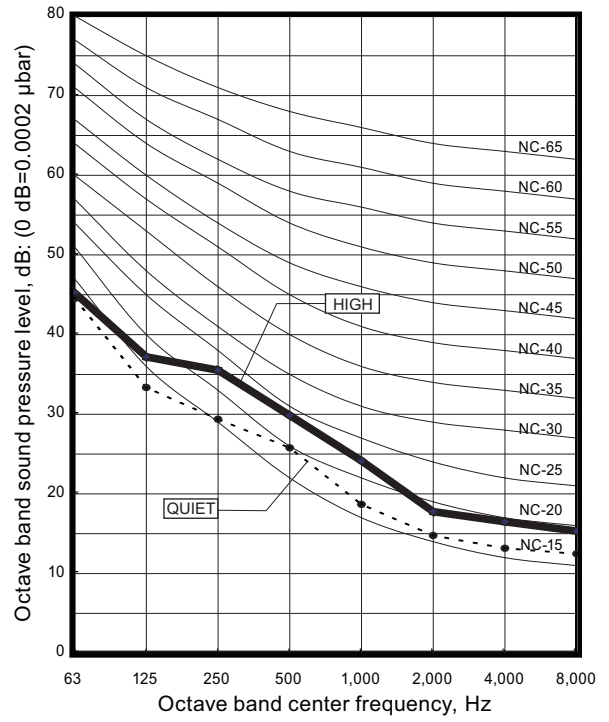

8-4. Medium static pressure duct type

Model: ARXG22KMLB

● Cooling

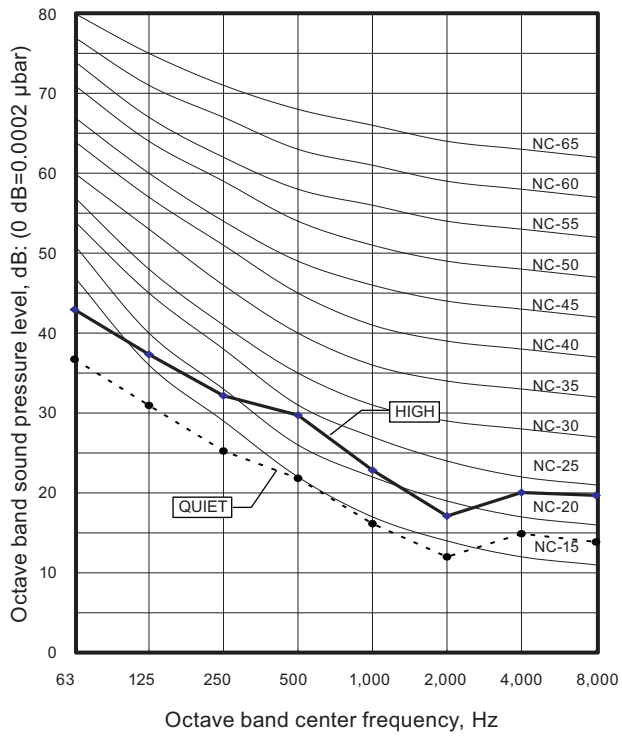

● Heating

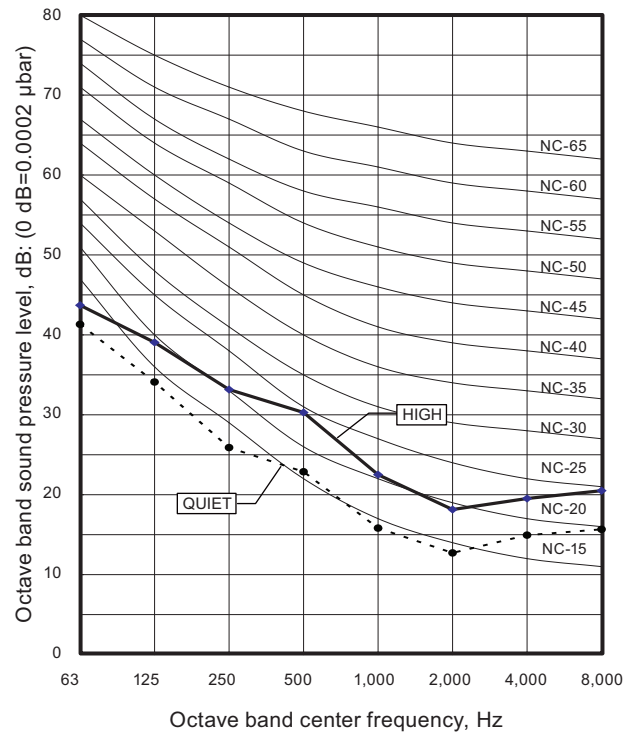

8-5. Wall mounted type

Model: ASYG07KGTB

Cooling

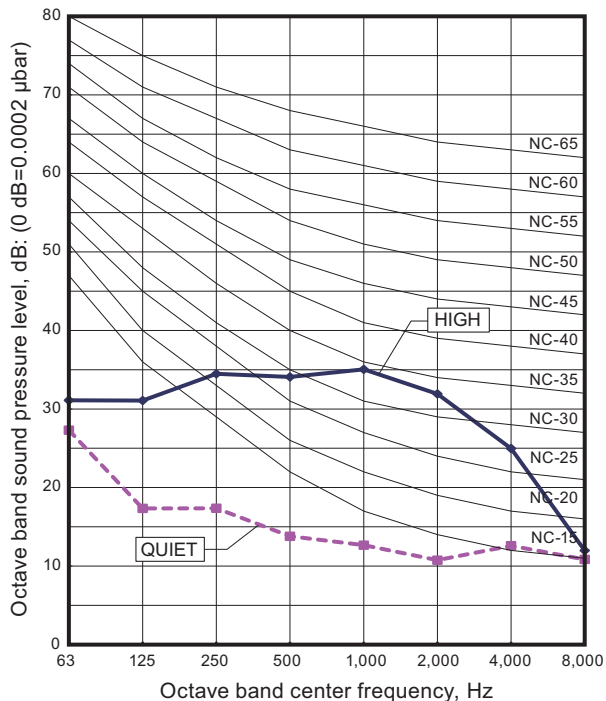

Heating

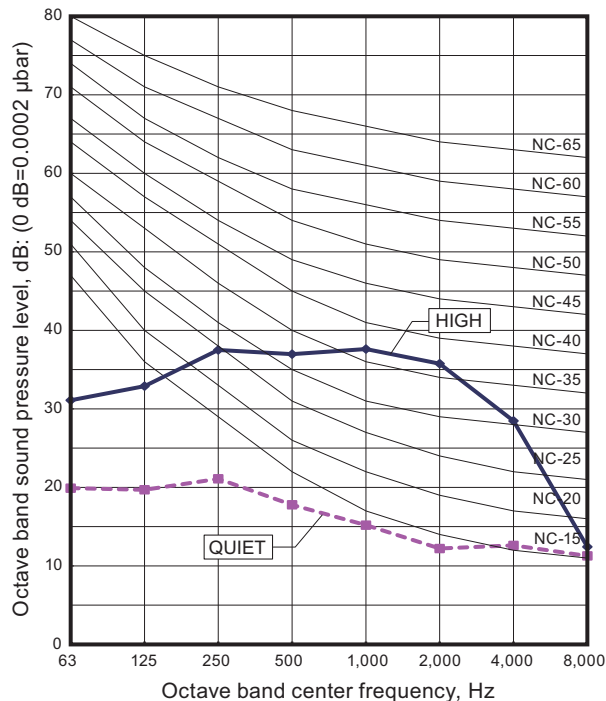

Model: ASYG09KGTB

Cooling

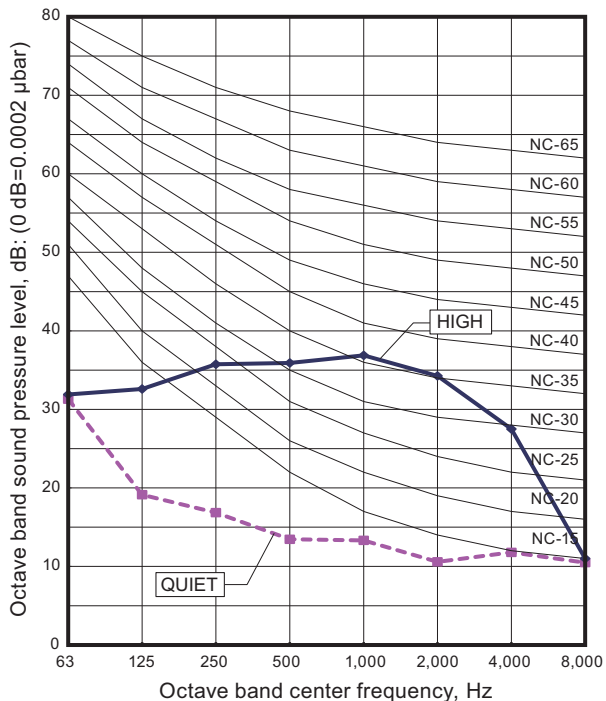

Heating

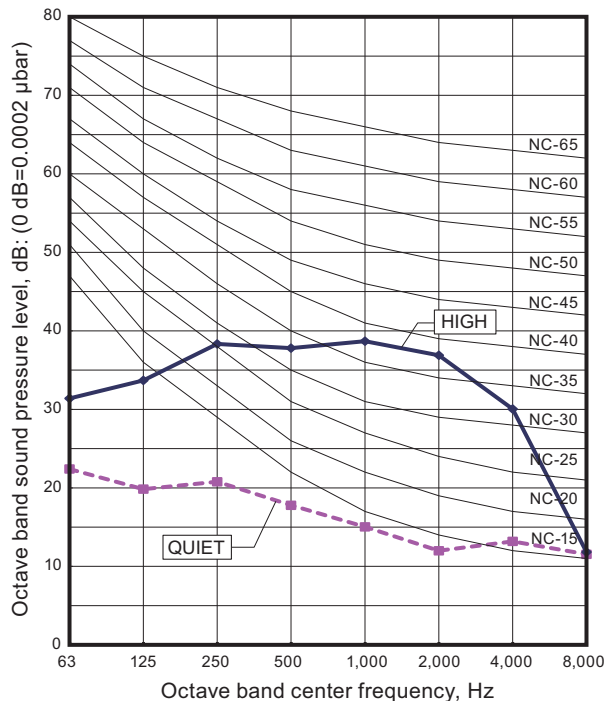

Model: ASYG12KGTB

Cooling

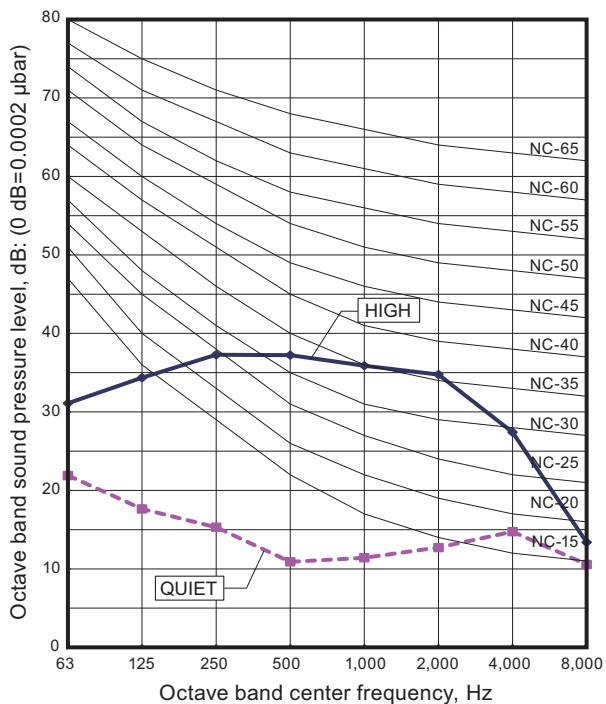

Heating

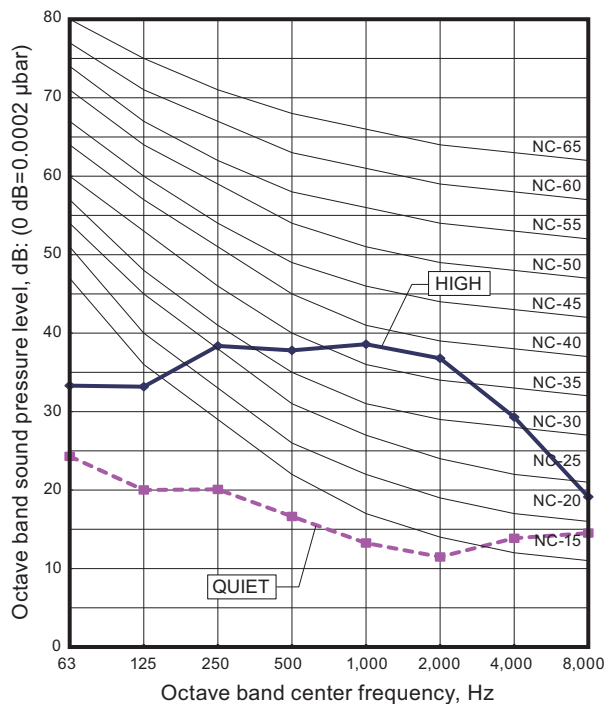

Model: ASYG14KGTB

Cooling

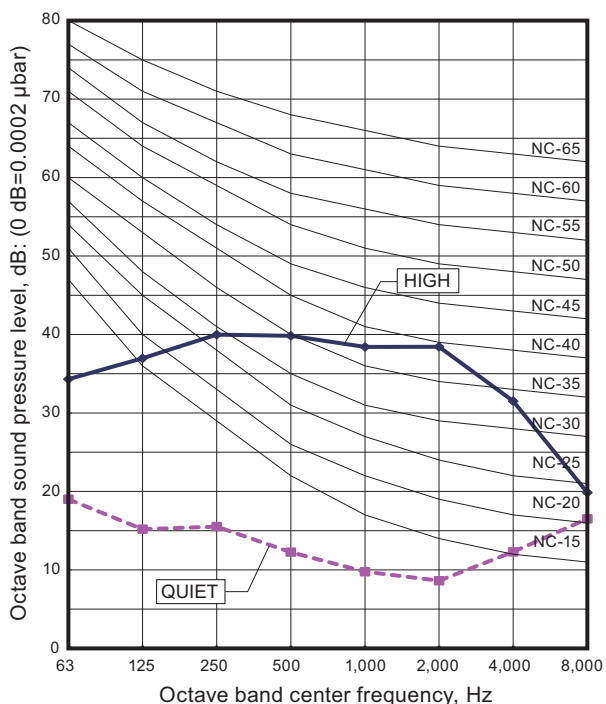

Heating

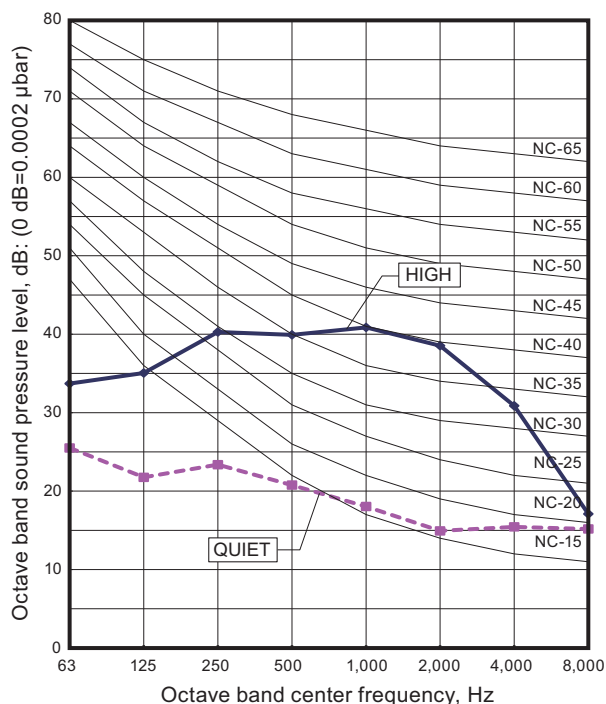

■ Model: ASYG18KMTB

● Cooling

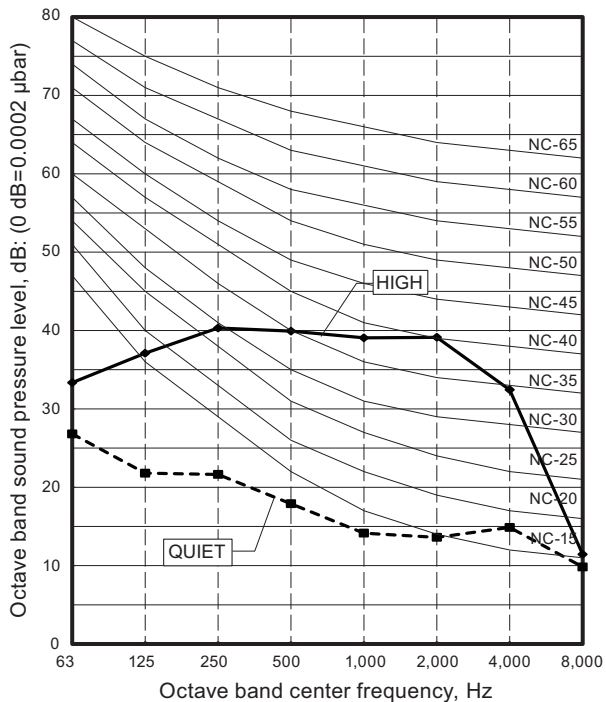

● Heating

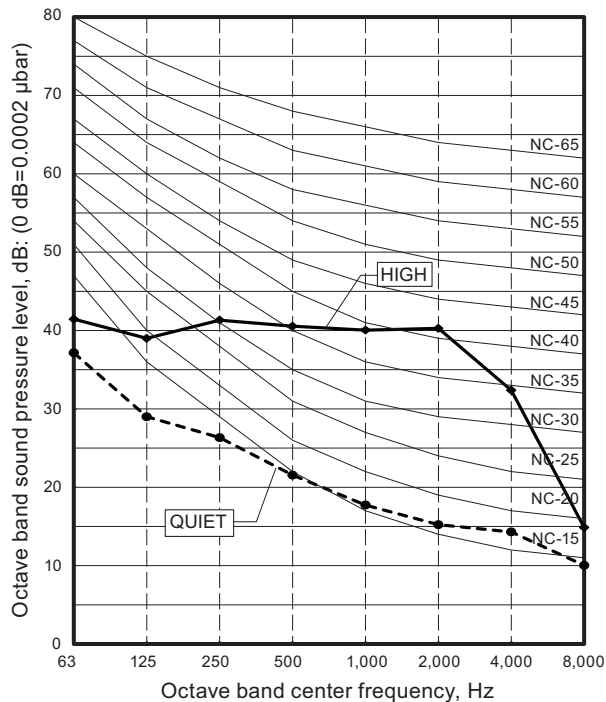

■ Model: ASYG22KMTB

● Cooling

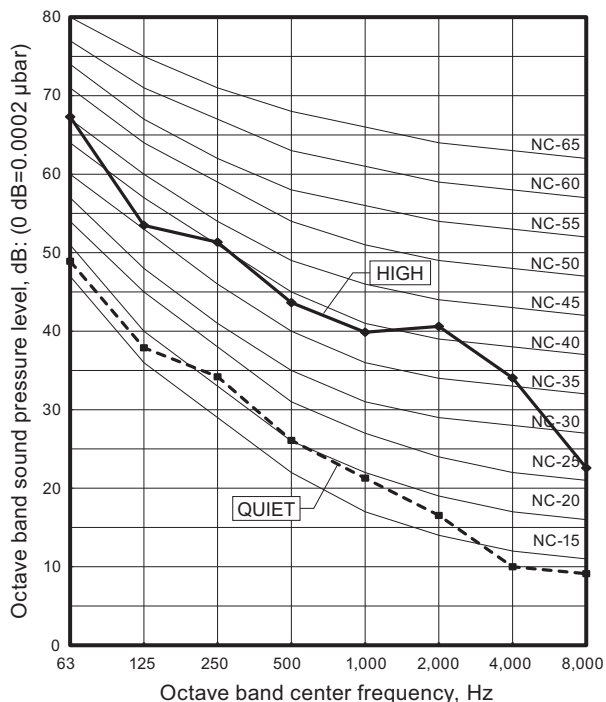

● Heating

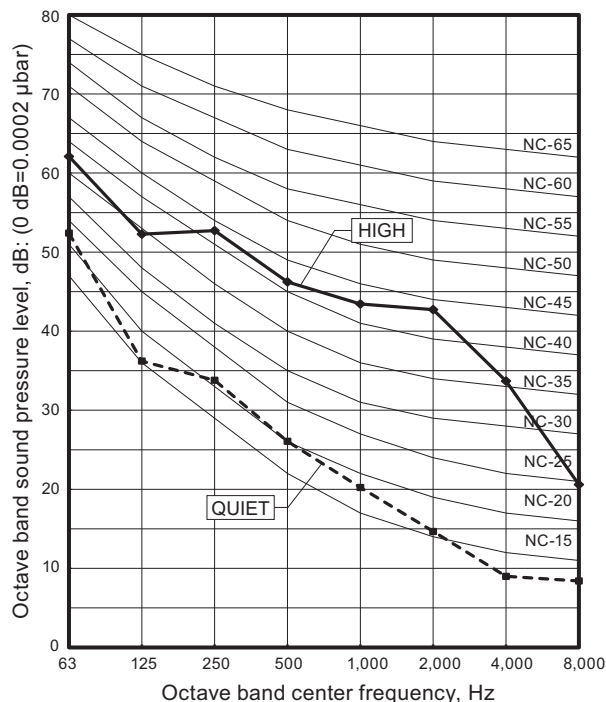

■ Model: ASYG24KMTB

● Cooling

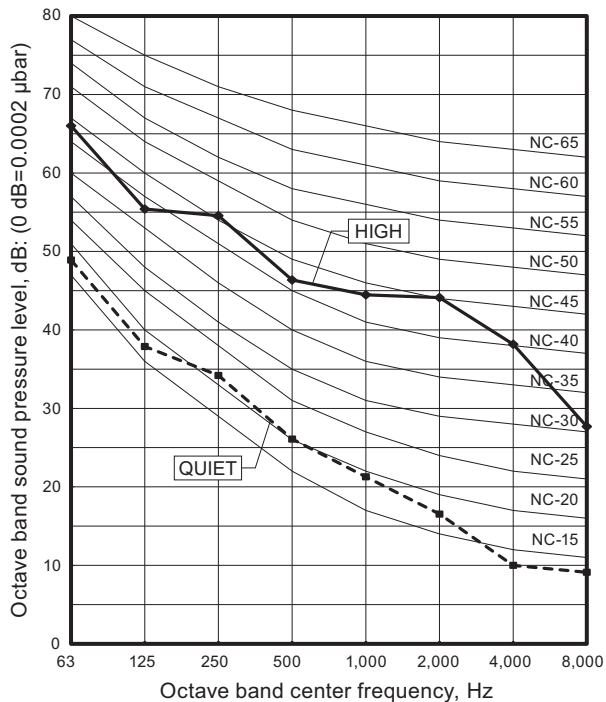

● Heating

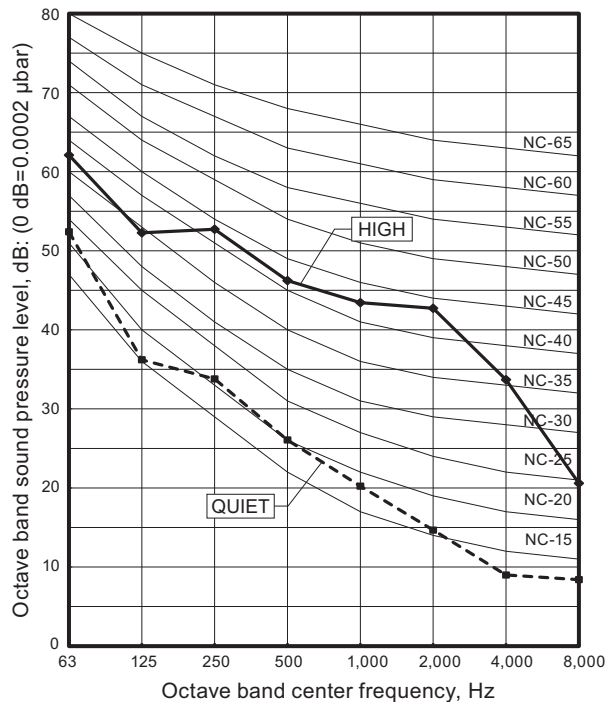

■ Models: ASYG07KMTB, ASYG07KMCC, ASYG07KETA, and ASYG07KETA-B

● Cooling

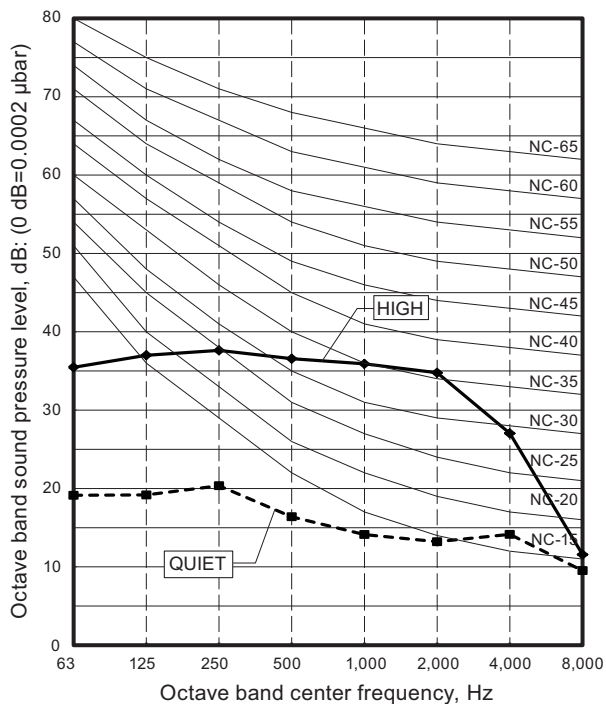

● Heating

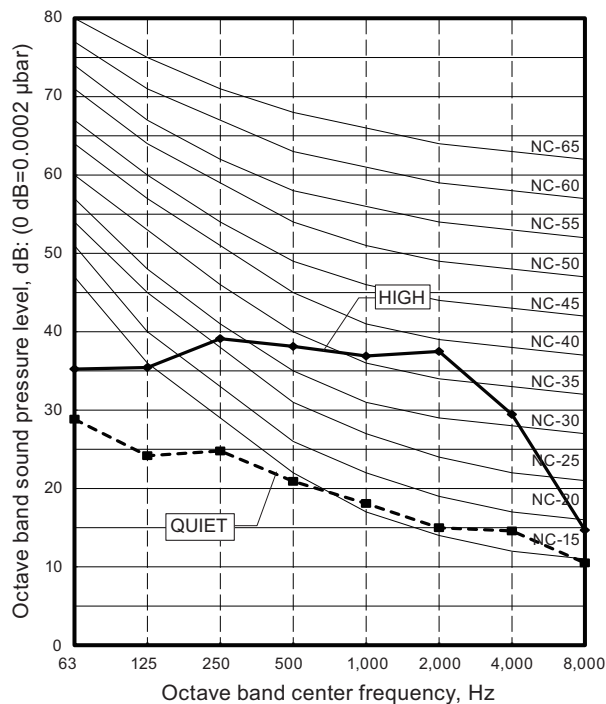

■ Models: ASYG09KMTB, ASYG09KMCC, ASYG09KETA, and ASYG09KETA-B

● Cooling

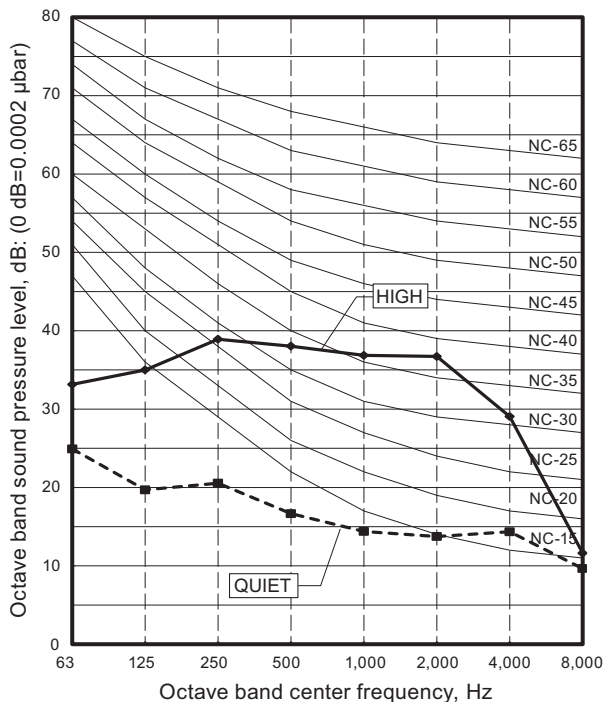

● Heating

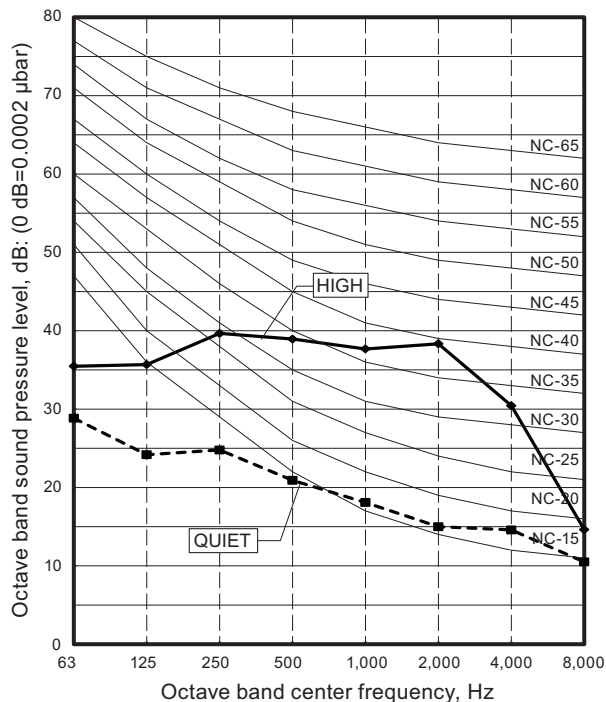

■ Models: ASYG12KMTB, ASYG12KMCC, ASYG12KETA, and ASYG12KETA-B

● Cooling

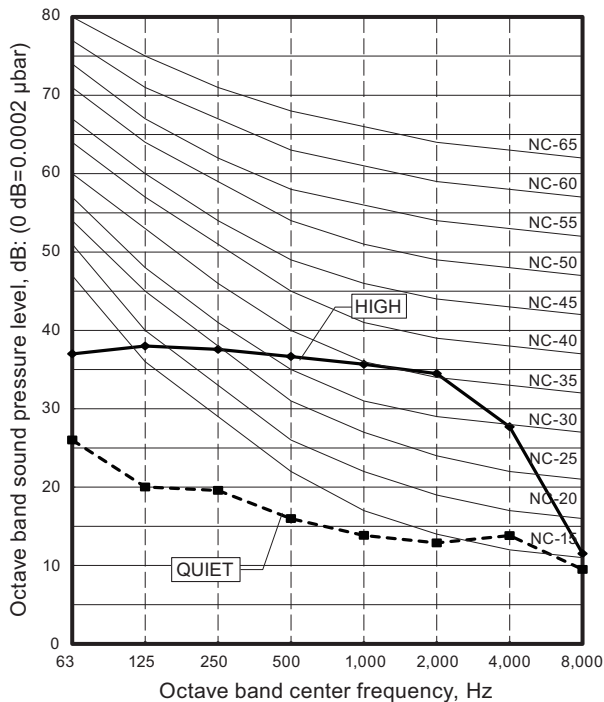

● Heating

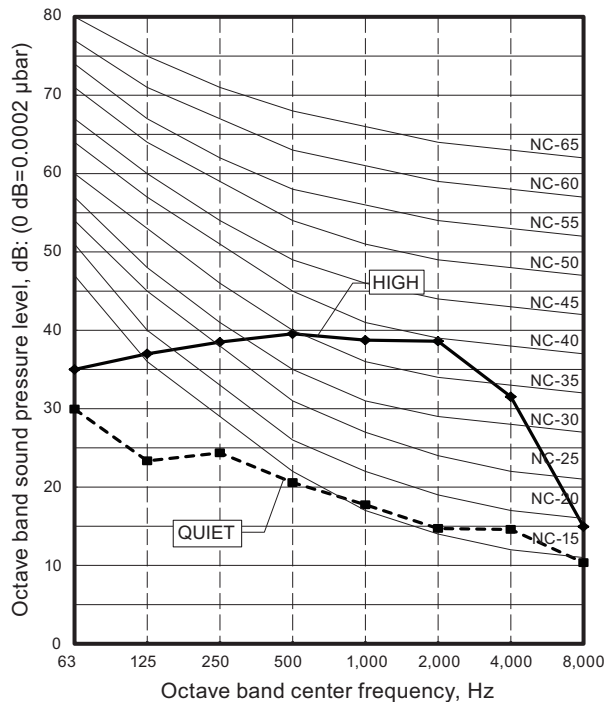

■ Models: ASYG14KMTB, ASYG14KMCC, ASYG14KETA, and ASYG14KETA-B

● Cooling

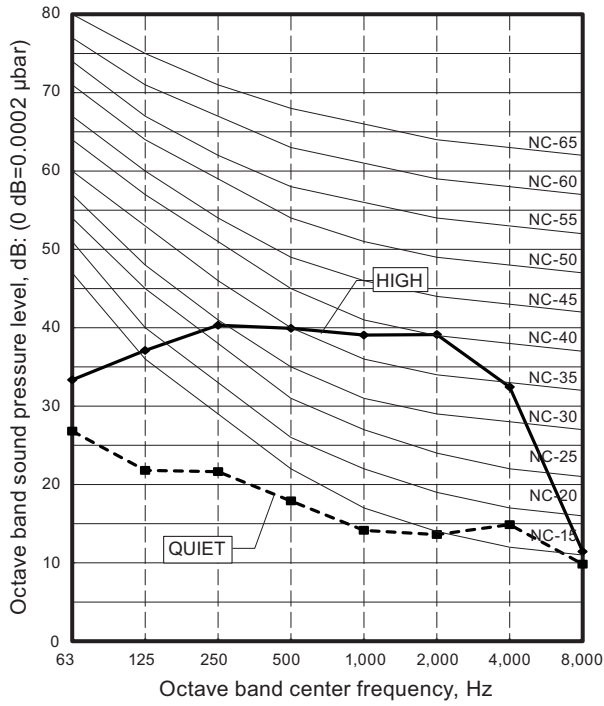

● Heating

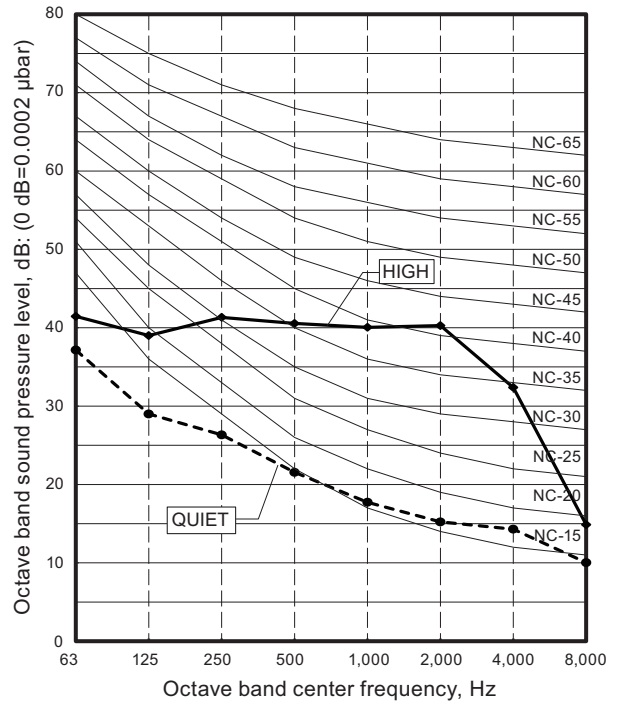

8-6. Ceiling type

Model: ABYG18KRTA

Cooling

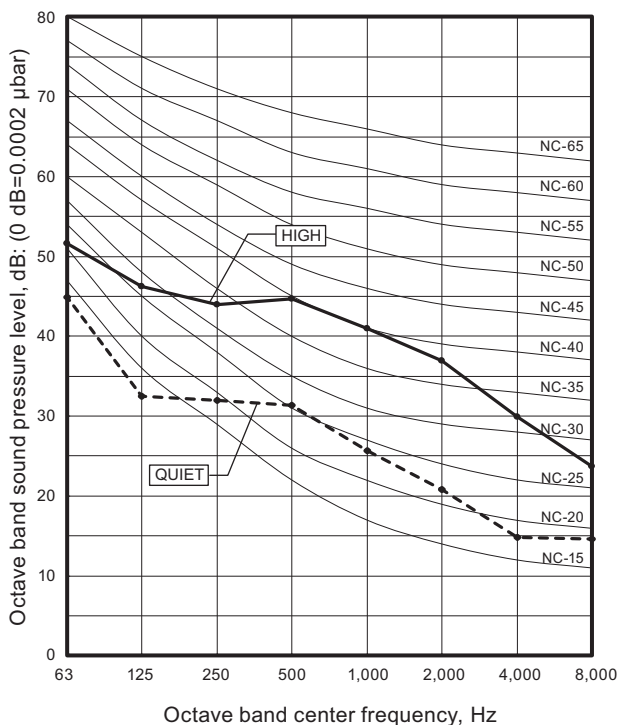

Heating

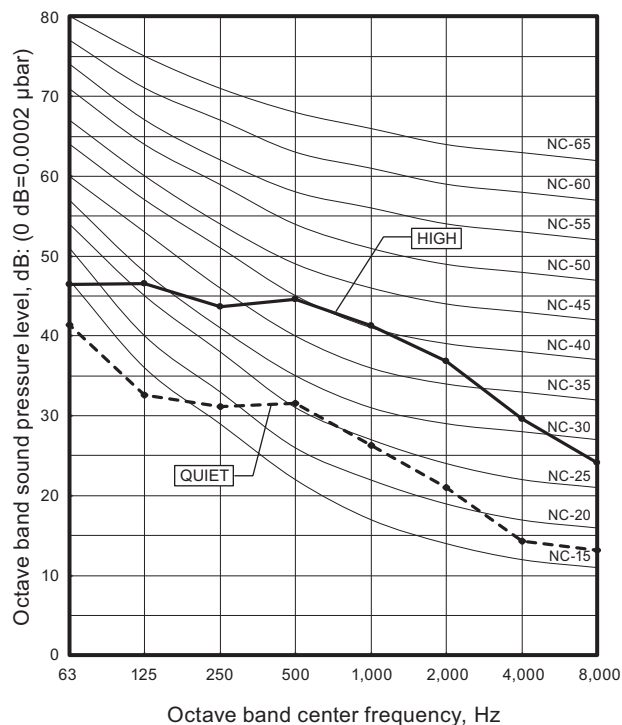

Model: ABYG22KRTA

Cooling

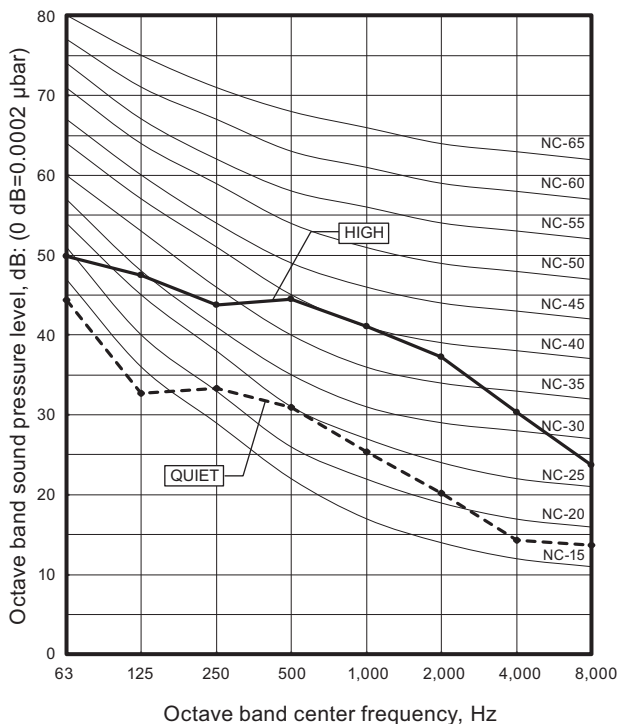

Heating

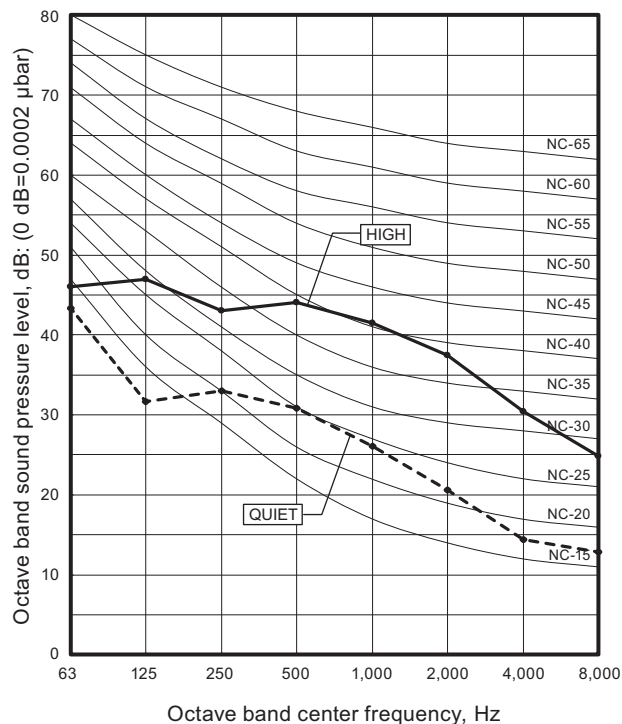

8-7. Floor type

Model: AGYG09KVCA

Cooling

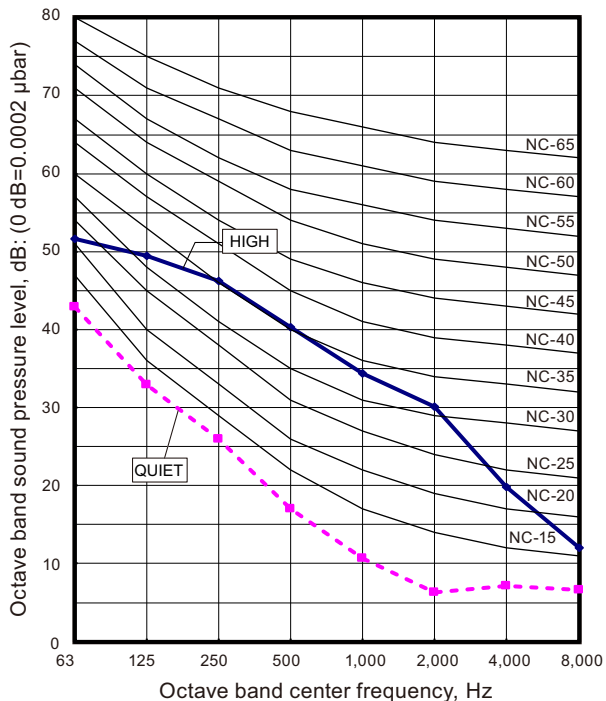

Heating

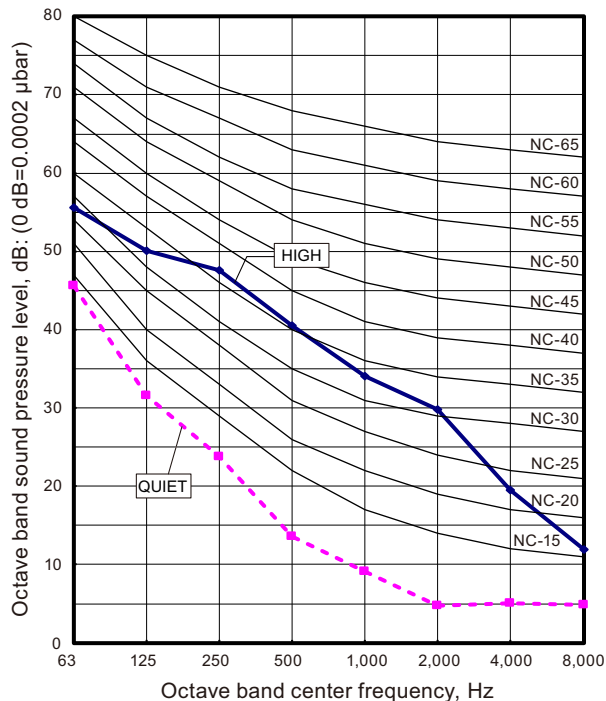

Model: AGYG12KVCA

Cooling

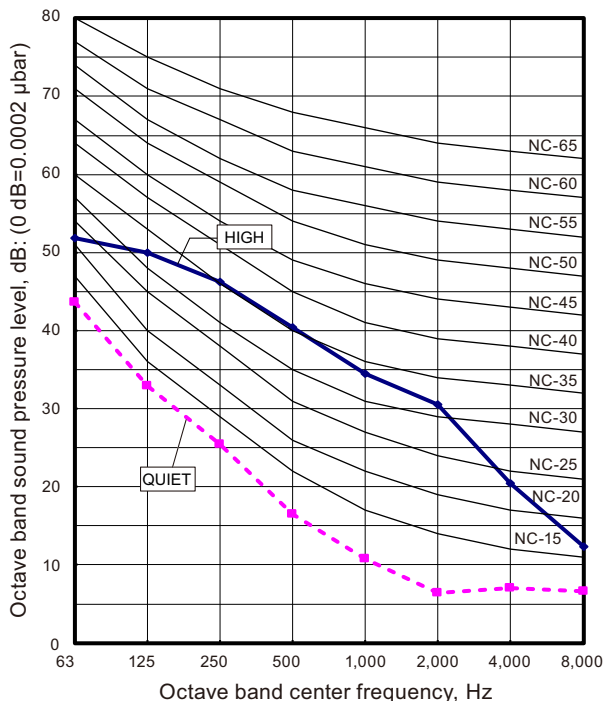

Heating

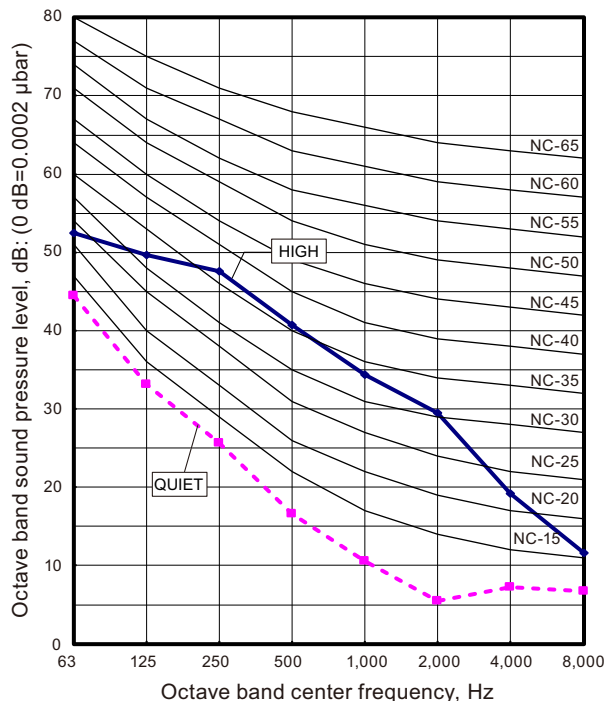

Model: AGYG14KVCA

● Cooling

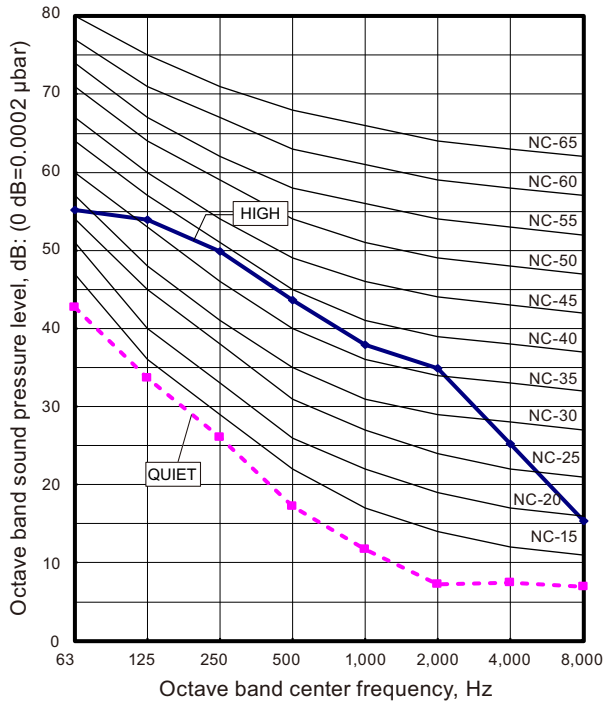

● Heating

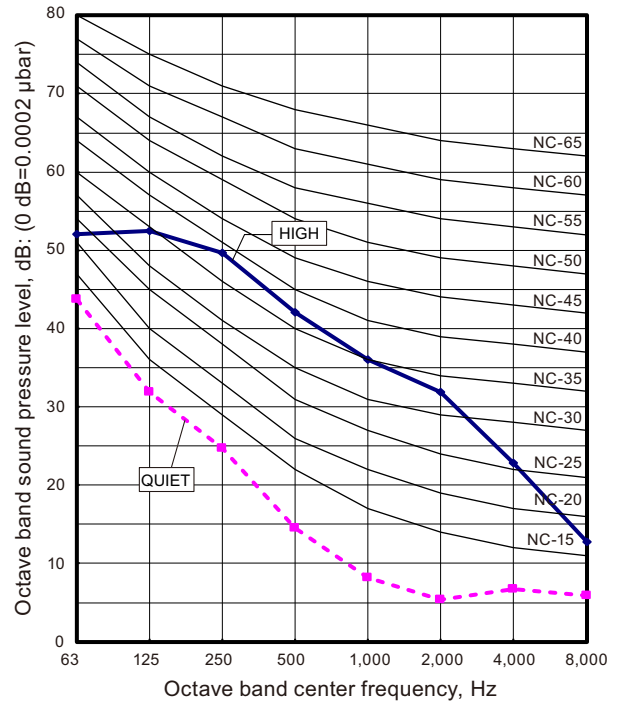

8-8. Sound level check point

■ Compact cassette type

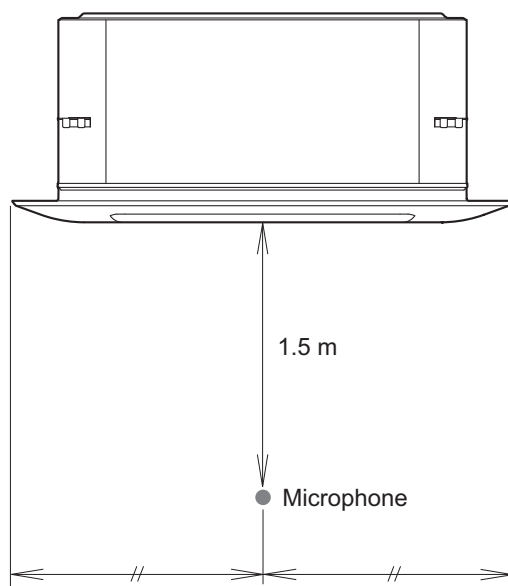
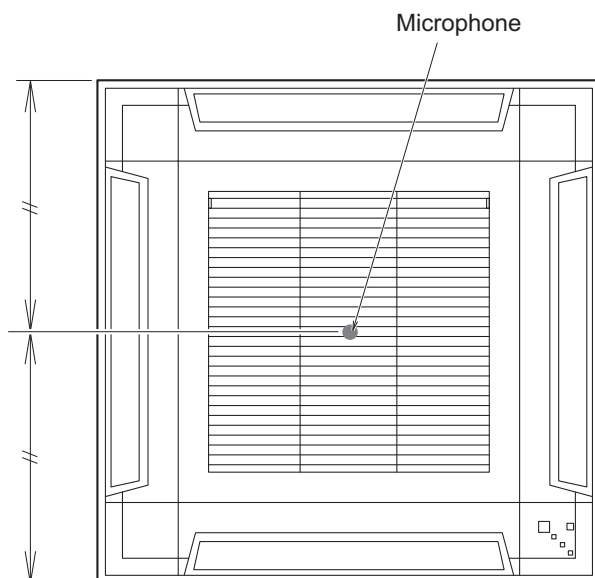

■ Mini duct type, Slim duct type, and Medium static pressure duct type

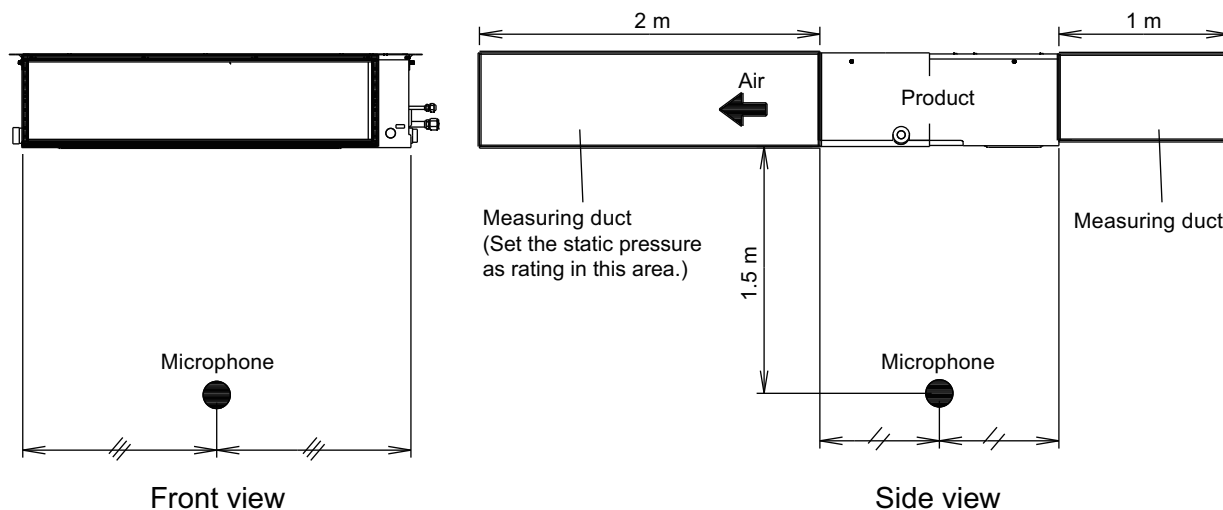

■ Wall mounted type

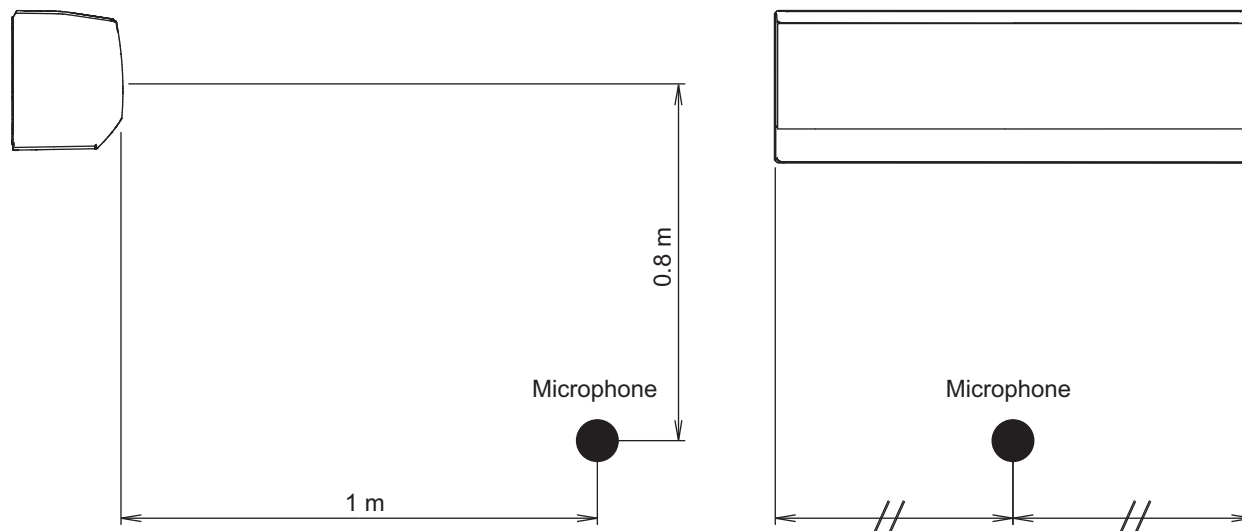

NOTE: Detailed shape of the actual indoor unit might be slightly different from the one illustrated above.

■ Ceiling type

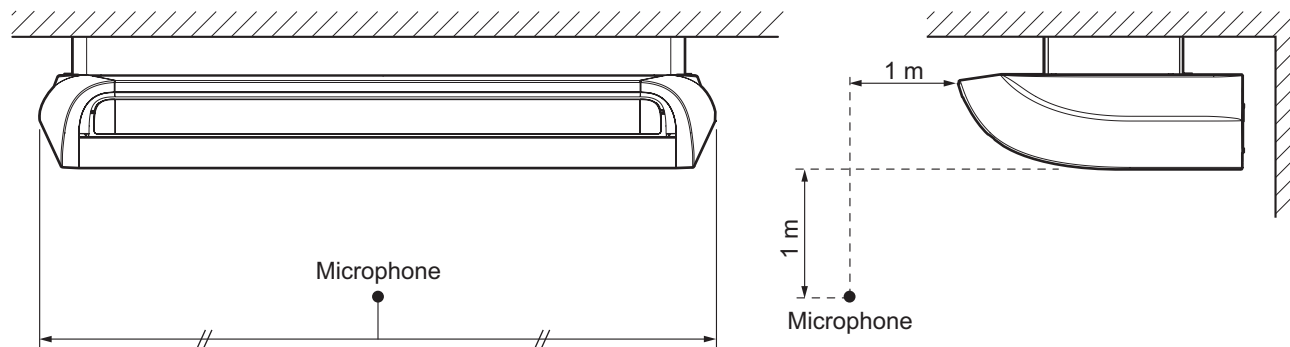

■ Floor type

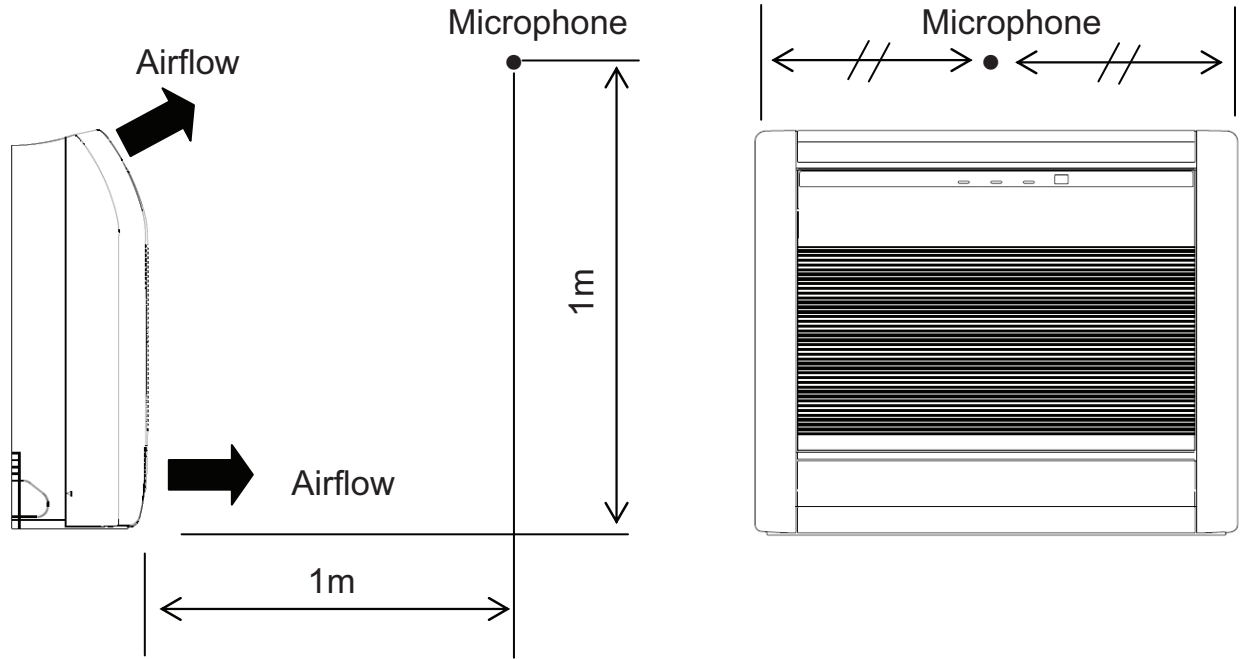

9. Electrical characteristics

		Power supply (50 Hz, 230 V)	Indoor rated		Wiring spec. of connection cable (Indoor unit to outdoor unit)	
Type	Model name	MCA	Input power	FLA	Cross- sectional area (mm ²)	Limited wiring length (m)
		(A)	(W)	(A)		
Compact cassette	AUXG07KVLA	0.19	18	0.15	1.5	26
	AUXG09KVLA	0.19	18	0.15		
	AUXG12KVLA	0.24	23	0.19		
	AUXG14KVLA	0.28	28	0.22		
	AUXG18KVLA	0.38	39	0.30		
	AUXG22KVLA	0.75	84	0.62		
Mini duct	ARXG07KSLAP	0.33	33	0.29	1.5	26
	ARXG09KSLAP	0.38	40	0.33		
	ARXG12KSLAP	0.42	47	0.38		
	ARXG14KSLAP	0.67	72	0.58		
	ARXG18KSLAP	0.61	63	0.49		
Slim duct	ARXG07KLLAP	0.41	33	0.33	1.5	26
	ARXG09KLLAP	0.38	49	0.30		
	ARXG12KLLAP	0.44	58	0.35		
	ARXG14KLLAP	0.64	76	0.51		
	ARXG18KLLAP	0.55	73	0.44		
Medium static pressure duct	ARXG22KMLB	1.00	94	0.60	1.5	26
Wall mounted	ASYG07KGTB	0.25	23	0.20	1.5	26
	ASYG09KGTB	0.30	27	0.24		
	ASYG12KGTB	0.30	27	0.24		
	ASYG14KGTB	0.37	33	0.29		
	ASYG18KMTB	0.44	38	0.35		
	ASYG22KMTB	0.49	47	0.39		
	ASYG24KMTB	0.55	62	0.44		
	ASYG07KMTB	0.25	23	0.20		
	ASYG09KMTB	0.30	27	0.24		
	ASYG12KMTB	0.30	27	0.24		
	ASYG14KMTB	0.38	33	0.30		
	ASYG07KMCC	0.25	23	0.20		
	ASYG09KMCC	0.30	27	0.24		
	ASYG12KMCC	0.30	27	0.24		
	ASYG14KMCC	0.38	33	0.30		
	ASYG07KETA ASYG07KETA-B	0.25	23	0.20		
	ASYG09KETA ASYG09KETA-B	0.30	27	0.24		
	ASYG12KETA ASYG12KETA-B	0.30	27	0.24		
	ASYG14KETA ASYG14KETA-B	0.38	33	0.30		
	Ceiling	ABYG18KRTA	0.39	37		
ABYG22KRTA		0.49	46	0.25		
Floor	AGYG09KVCA	0.19	16	0.15	1.5	26
	AGYG12KVCA	0.23	20	0.18		
	AGYG14KVCA	0.25	23	0.20		

MCA: Minimum Circuit Ampacity = Maximum operating current (Full load)

FLA: Full Load Amperes (Fan motor)

10. Safety devices

Indoor unit type	Model name	PCB* fuse	Fan motor thermal protector	Terminal thermal fuse	Float switch
Compact cassette	AUXG07KVLA	250 V, 5 A	Activate: 100 ±15 °C Fan motor stop Reset: 95 ±10 °C Fan motor restart	—	○
	AUXG09KVLA				
	AUXG12KVLA				
	AUXG14KVLA				
	AUXG18KVLA				
	AUXG22KVLA				
Mini duct	ARXG07KSLAP		Activate: 135 ±15 °C Fan motor stop Reset: 105 ±15 °C Fan motor restart		
	ARXG09KSLAP				
	ARXG12KSLAP				
	ARXG14KSLAP				
	ARXG18KSLAP				
Slim duct	ARXG07KLLAP		Activate: 135 ±15 °C Fan motor stop Reset: 115 ±15 °C Fan motor restart		
	ARXG09KLLAP				
	ARXG12KLLAP				
	ARXG14KLLAP				
	ARXG18KLLAP				
Medium static pressure duct	ARXG22KMLB				

Indoor unit type	Model name	PCB* fuse	Fan motor thermal protector	Terminal thermal fuse	Float switch
Wall mounted	ASYG07KGTB	250 V, 3.15 A	Activate: 110 ±15 °C Fan motor speed down Reset: 110 ±15 °C Fan motor speed recover	102 °C Off	—
	ASYG09KGTB				
	ASYG12KGTB				
	ASYG14KGTB				
	ASYG18KMTB				
	ASYG22KMTB				
	ASYG24KMTB				
	ASYG07KMTB				
	ASYG09KMTB				
	ASYG12KMTB				
	ASYG14KMTB				
	ASYG07KMCC				
	ASYG09KMCC				
	ASYG12KMCC				
	ASYG14KMCC				
	ASYG07KETA ASYG07KETA-B		250 V, 3.15 A		
ASYG09KETA ASYG09KETA-B					
ASYG12KETA ASYG12KETA-B					
ASYG14KETA ASYG14KETA-B					
Ceiling	ABYG18KRTA	250 V, 3.15 A	Activate: 135 ±15 °C Fan motor stop Reset: 105 ±15 °C Fan motor restart	108 °C Off	—
	ABYG22KRTA	250V, 5.0 A			
Floor	AGYG09KVCA	250V, 5.0 A	Activate: 150 ±15 °C Fan motor stop Reset: 120 ±15 °C Fan motor restart	110 °C Off	—
	AGYG12KVCA				
	AGYG14KVCA				

*: Printed Circuit Board

11. External input and output

11-1. Compact cassette type, Mini duct type, Slim duct type, and Medium static pressure duct type

Exterior of the indoor unit PCB and the component location differ by the type of the indoor unit as follows.

- **Compact cassette type:**

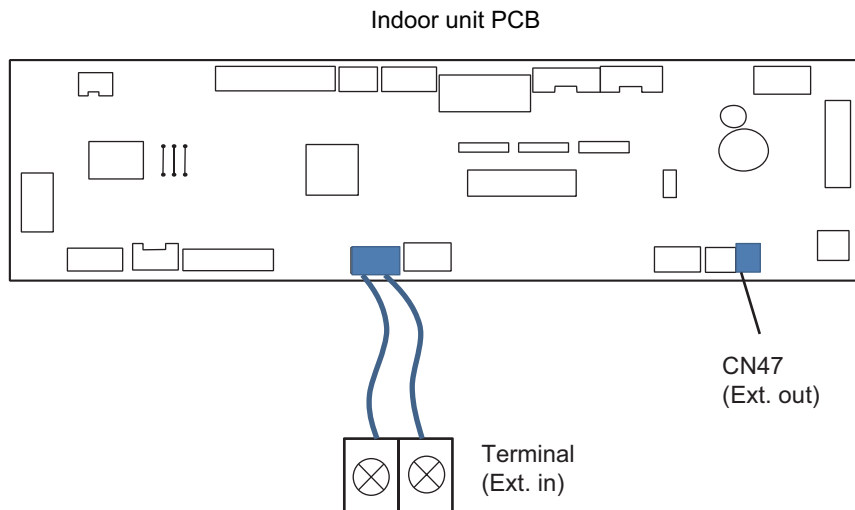

- **Mini duct type, Slim duct type, and Medium static pressure duct types:**

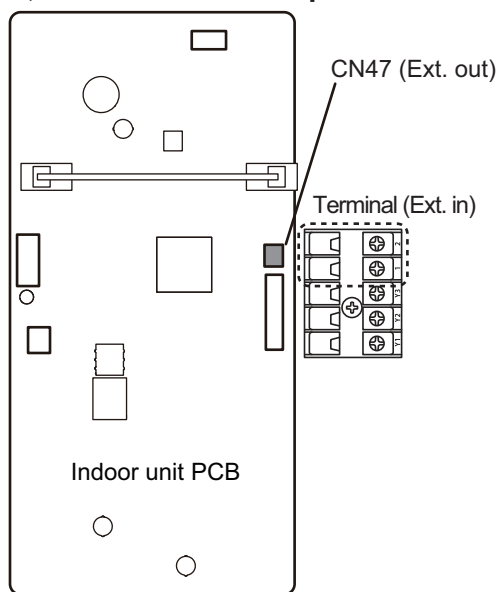

External input and output		Connector	Input select	Input signal	External connect kit (Optional parts)
External input	Operation/Stop Forced stop	Terminal	Dry contact	Edge	—
External output	Operation status	CN47	—	—	UTY-XWZXZG
	Error status				
	Indoor unit fan operation status				
	External heater output				

External input

With using external input function, some functions on this product can be controlled from an external device.

- "Operation/Stop" mode or "Forced stop" mode can be selected with function setting of indoor unit.
- A twisted pair cable (22AWG) should be used. Maximum length of cable is 150 m.
- The wire connection should be separate from the power cable line.

Indoor unit functions such as Operation/Stop can be done by using indoor unit terminals.

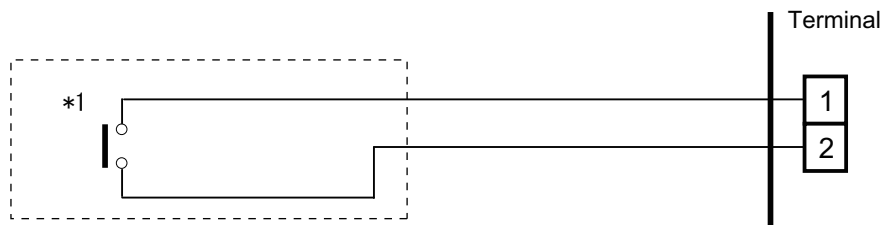

*1: The switch can be used on the following condition: DC 12 V to 24 V, 1 mA to 15 mA.

External output

Use an external output cable with appropriate external dimension, depending on the number of cables to be installed.

- A twisted pair cable (22AWG) should be used. Maximum length of cable is 25 m.
- Output voltage: High DC 12 V \pm 2 V, Low 0 V.
- Permissible current: 50 mA
- For details, refer to "[Combination of external input and output](#)" on page 152.

When indicator, etc. are connected directly

Example: Function setting 60 is set to "00"

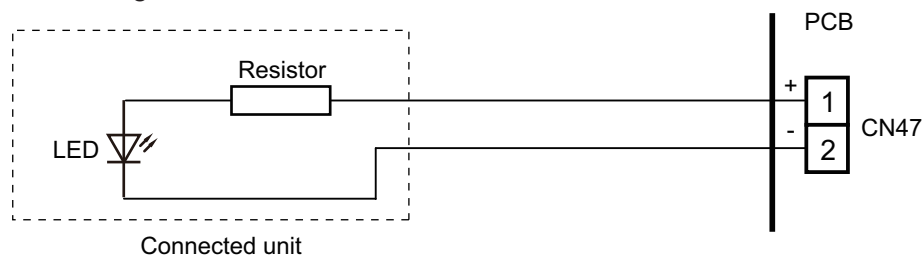

When connecting with a device equipped with a power supply

Example: Function setting 60 is set to "00"

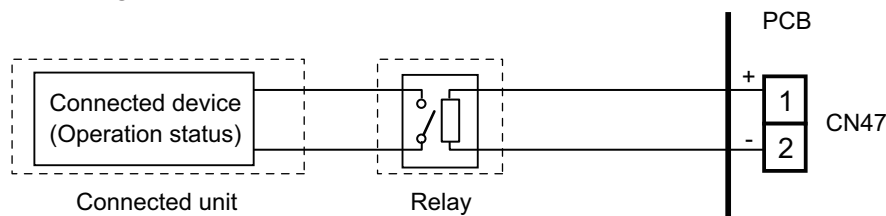

■ Combination of external input and output

By combining the function setting of the indoor unit, you can select various combinations of functions.

Combination examples of external input and output are as follows:

Mode	Function setting	External input	External output
		Terminal	CN47
0	60—00	Operation/Stop	
1—8	60—01 to 60—08	(Setting prohibited)	
9	60—09	Operation/Stop	Error status
10	60—10	Operation/Stop	Indoor unit fan operation status
11	60—11	Operation/Stop	External heater output

NOTE: Input of Operation/Stop depends on the setting of function setting 46.

- 00: Operation/Stop mode 1 (R.C. enabled)
- 01: (Setting prohibited)
- 02: Forced stop
- 03: Operation/Stop mode 2 (R.C. disabled)

● Input signal type

- Indoor unit
Input signal type is only "Edge".

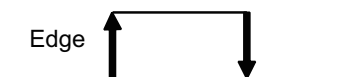

■ Details of function

● Control input function

- When function setting is "Operation/Stop" mode 1

Function setting	External input	Input signal	Command
46—00	Terminal	Off → On	Operation
		On → Off	Stop

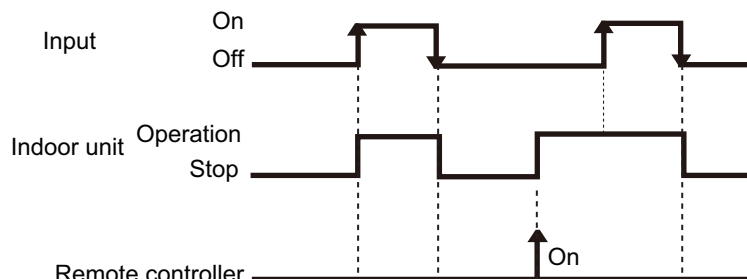

NOTES:

- The last command has priority.
- The indoor units within the same remote controller group operates in the same mode.

- When function setting is "Forced stop" mode

Function setting	External input	Input signal	Command
46—02	Terminal	Off → On	Forced stop
		On → Off	Normal

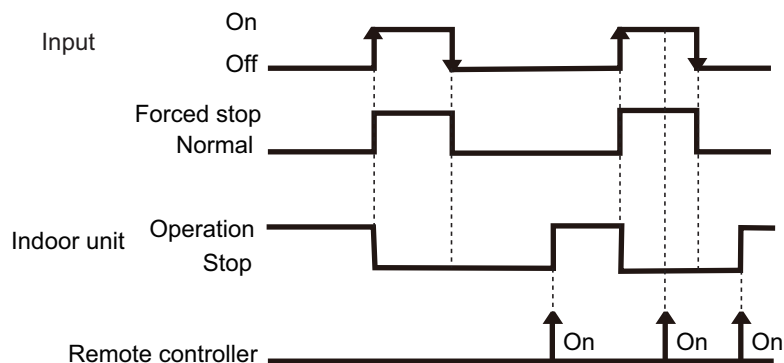

NOTES:

- When the forced stop is triggered, indoor unit stops and Operation/Stop operation by the remote controller is restricted.
- When forced stop function is used with forming a remote controller group, connect the same equipment to each indoor unit within the group.

• When function setting is "Operation/Stop" mode 2

Function setting	External input	Input signal	Command
46—03	Terminal	Off → On	Operation
		On → Off	Stop (R.C. disabled)

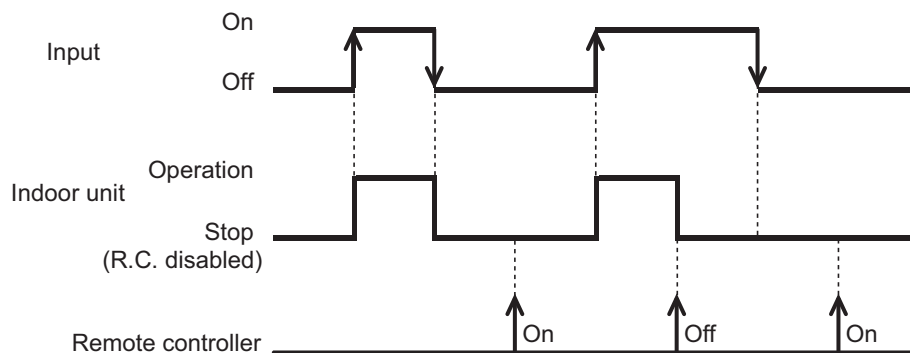

NOTE: When "Operation/Stop" mode 2 function is used with forming a remote controller group, connect the same equipment to each indoor unit within the group.

● Control output function

Function setting	External output	Output signal	Command
60—00	CN47	Low → High	Operation
		High → Low	Stop

The output is low when the unit is stopped.

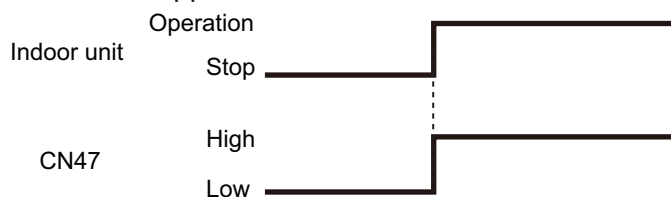

● Error status

Function setting	External output	Output signal	Command
60—09	CN47	Low → High	Error
		High → Low	Normal

The output is ON when an error is generated for the indoor unit.

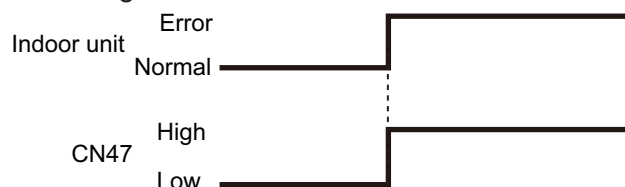

● Indoor unit fan operation status

Function setting	External output	Output signal	Command
60—10	CN47	Low → High	Fan run
		High → Low	Fan stop

Output signal	Condition
On	The indoor unit fan is operating.
Low → High	
Off	The fan is stopped or during cold air prevention. During thermostat off when in dry mode operation.
High → Low	

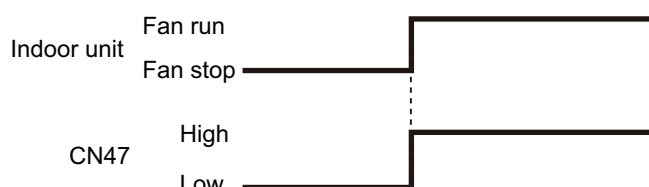

● External heater output

Function setting	External output	Output signal	Command
60—11	CN47	Low → High	Heater on
		High → Low	Heater off

Output signal	Condition
Low → High	Heater turns on as shown in diagram of heating temperature
Off → On	
High → Low	Heater turns off as shown in diagram of heating temperature
On → Off	<ul style="list-style-type: none"> • Other than Heating mode • Error occurred • Forced thermo off • Fan stop protection

Specifications of the signal output performance are as shown as follows:

Example When set temperature (T_s) is set at 22 °C;

- And room temperature (T_r) increase above 12 °C, signal output is on.
- And T_r increase above 21 °C, signal output is off.
- And T_r decrease below 19 °C, signal output is on.
- And T_r decrease below 10 °C, signal output is off.

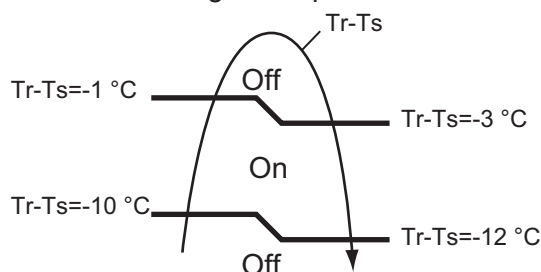

The output also turns off in defrost operation.

11-2. Wall mounted type (KGTB, 18-24KMTB, KETA, and KETA-B)

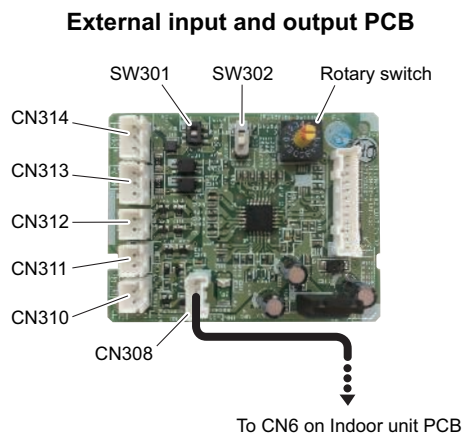

PCB	External input	External output	Connector	Input select	Input signal	
External input and output (UTY-XCSXZ2)	Operation/Stop	-	CN313/ CN314	Dry contact/ Apply voltage	Edge/Pulse	
	Forced stop		CN313		Edge	
	Forced thermostat off					
	-		Operation status	CN310	-	-
			Error status	CN311		
			Indoor unit fan operation status	CN312		

NOTE: KETA, KETA-B: External input and output PCB cannot be used with Wireless LAN adapter simultaneously.

External input

With using external input function, some functions on this product can be controlled from an external device.

- "Operation/Stop" mode or "Forced stop" mode can be selected with function setting of indoor unit.
- A twisted pair cable should be used. Maximum length of cable is 150 m.
- The wire connection should be separate from the power cable line.

External input and output PCB

The indoor unit Operation/Stop can be set by using the input connector on the PCB.

Input select:

Use either one of these types of connectors according to the application. (Both types of connectors cannot be used simultaneously.)

– Dry contact

In case of internal power supply, set the slide switch of SW301 to "NON VOL" side.

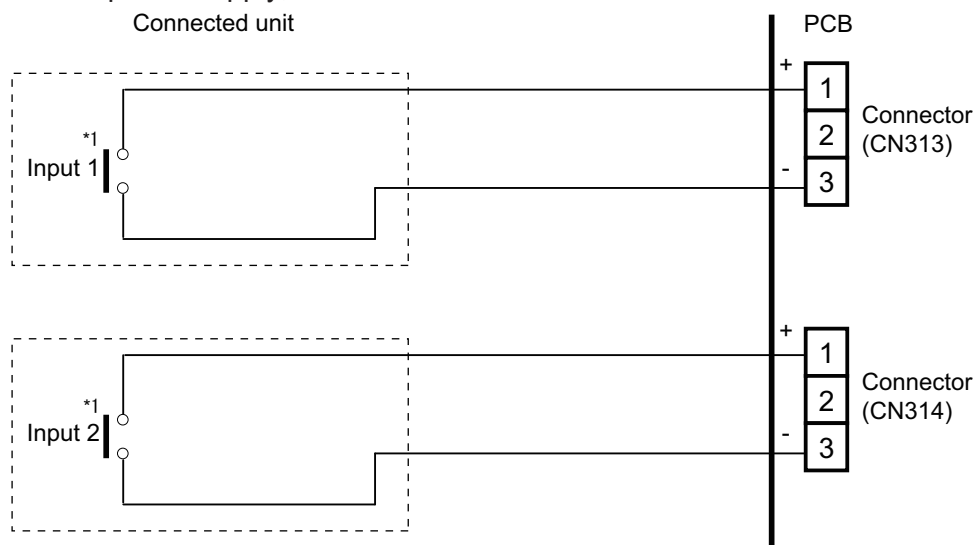

*1: The switches can be used on the following condition: DC 12 V to 24 V, 1 mA to 15 mA.

– Apply voltage

In case of external power supply, set the slide switch of SW301 to "VOL" side.

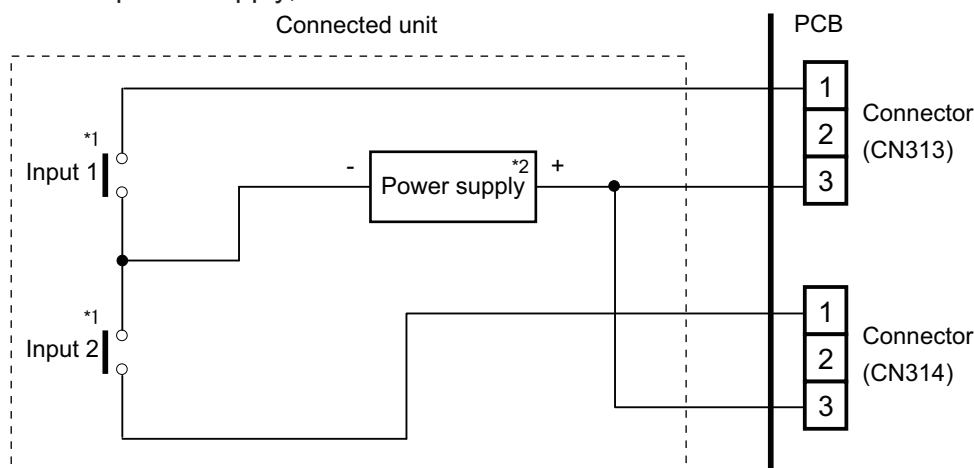

*1: The switches can be used on the following condition: DC 12 V to 24 V, 1 mA to 15 mA.

*2: Make the power supply DC 12 to 24 V, 10 mA or more.

External output

Use an external output cable with appropriate external dimension, depending on the number of cables to be installed.

External input and output PCB

- A twisted pair cable (22AWG) should be used. Maximum length of cable is 25 m.
- Output voltage: High DC 12 V \pm 2 V, Low 0 V.
- Permissible current: 50 mA
- For details, refer to ["Combination of external input and output"](#) on page 159.

- **When indicator or other components are connected directly:**

Example: Function setting 60 is set to "00".

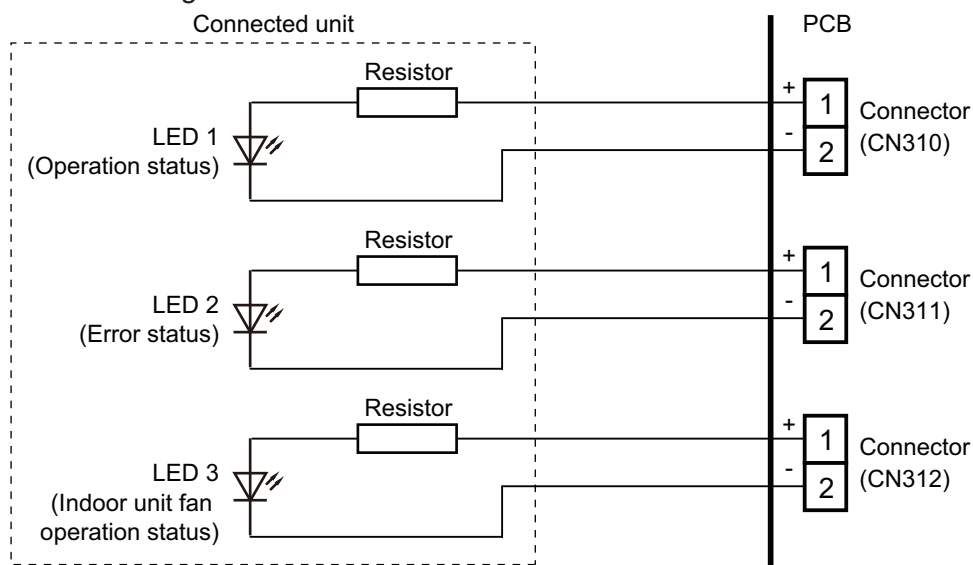

- **When connecting with a device equipped with a power supply:**

Example: Function setting 60 is set to "00".

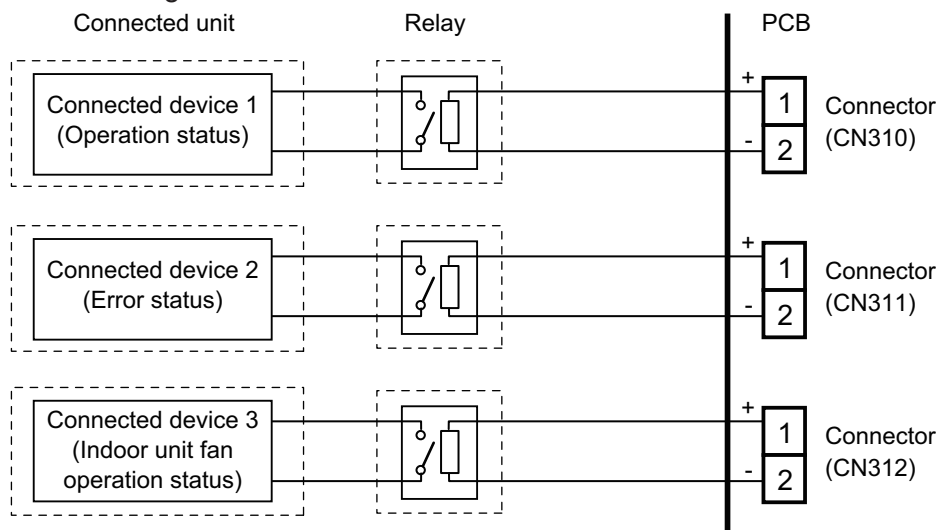

■ Combination of external input and output

By combining the function setting of the indoor unit and rotary switch setting of the External input and output PCB, you can select various combinations of functions.

Combination examples of external input and output are as follows:

Mode	Function setting	External input and output PCB (Rotary SW)	External input		
			External input and output PCB		
			CN313	CN314	Signal type
0-1	60-00	1	Operation/Stop	Not available	Edge
			Operation	Stop	Pulse
0-2	60-00	2	Forced Thermostat OFF	Not available	Edge
1—8	60-01 to 60-08	3 - 9, A	(Setting prohibited)		
9	60-09	B	Forced Thermostat OFF	Not available	Edge
10	60-10	C	Forced Thermostat OFF	Not available	Edge
11	60-11	D	Forced Thermostat OFF	Not available	Edge

Mode	Function setting	External input and output PCB (Rotary SW)	External output		
			External input and output PCB		
			CN310	CN311	CN312
0-1	60-00	1	Operation/Stop	Error status	Indoor unit fan operation status
0-2	60-00	2	Error status	Indoor unit fan operation status	Not available
1—8	60-01 to 60-08	3 - 9, A	(Setting prohibited)		
9	60-09	B	Operation/Stop	Indoor unit fan operation status	Not available
10	60-10	C	Operation/Stop	Error status	Not available
11	60-11	D	Operation/Stop	Indoor unit fan operation status	Error status

NOTE: Input of Operation/Stop depends on the setting of function setting 46.

00: Operation/Stop mode 1 (R.C. enabled)

01: (Setting prohibited)

02: Forced stop

03: Operation/Stop mode 2 (R.C. disabled)

● Input signal type

External input and output PCB:

The input signal type can be selected.

Signal type (edge or pulse) can be switched by the DIP switch SW302 on the External input and output PCB.

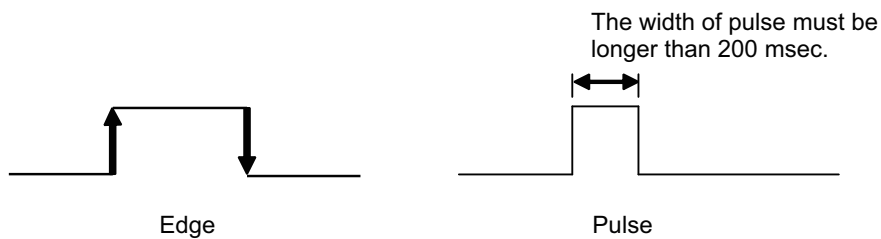

■ Details of function

● Control input function

- When function setting is "Operation/Stop" mode 1

- In the case of "Edge" input:

Function setting /	Rotary SW on External input and output PCB	External input		Input signal	Command
		External input and output PCB	CN313	Off → On	Operation
46-00	60-00 / 1			On → Off	Stop

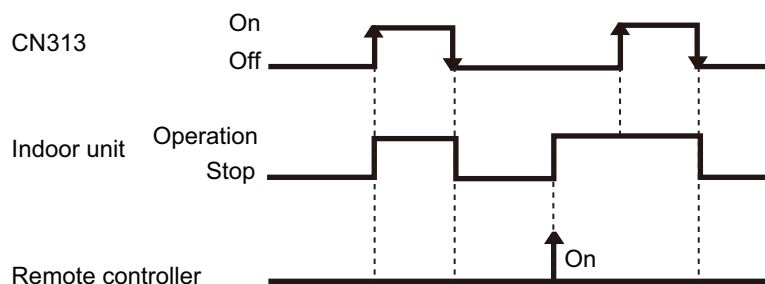

- In the case of "Pulse" input:

Function setting /	Rotary SW on External input and output PCB	External input		Input signal	Command
		External input and output PCB	CN313	Pulse	Operation
46-00	60-00 / 1		CN314	Pulse	Stop

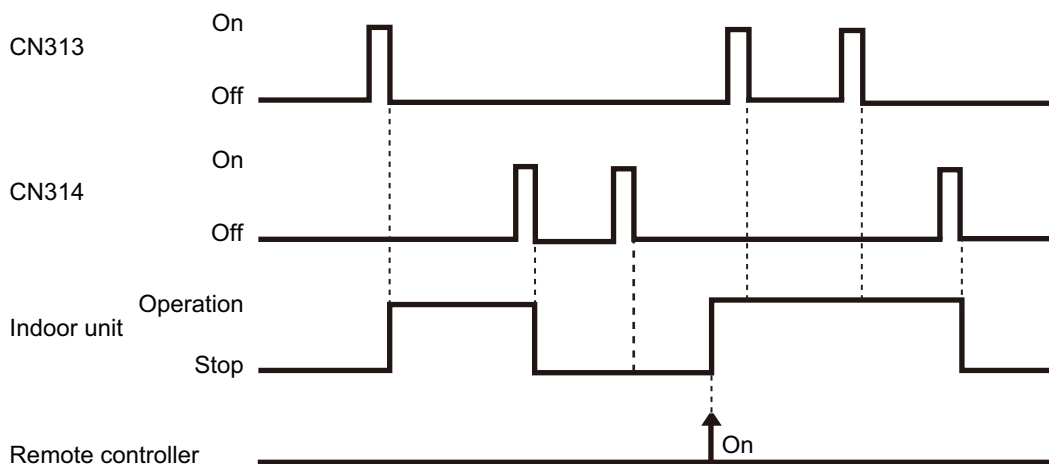

NOTES:

- The last command has priority.
- The indoor units within the same remote controller group operates in the same mode.

• When function setting is "Forced stop" mode

– In the case of "Edge" input:

Function setting /	Rotary SW on External input and output PCB	External input		Input signal	Command
		External input and output PCB	CN313	Off → On	Forced stop
46-02	60-00 / 1			On → Off	Normal

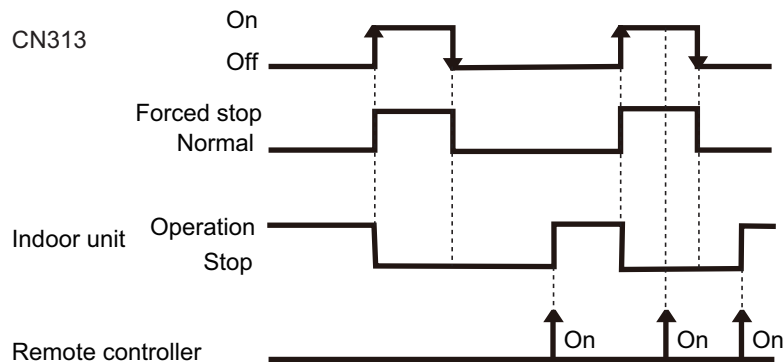

– In the case of "Pulse" input:

Function setting /	Rotary SW on External input and output PCB	External input		Input signal	Command
		External input and output PCB	CN313	Pulse	Forced stop
46-02	60-00 / 1		CN314	Pulse	Normal

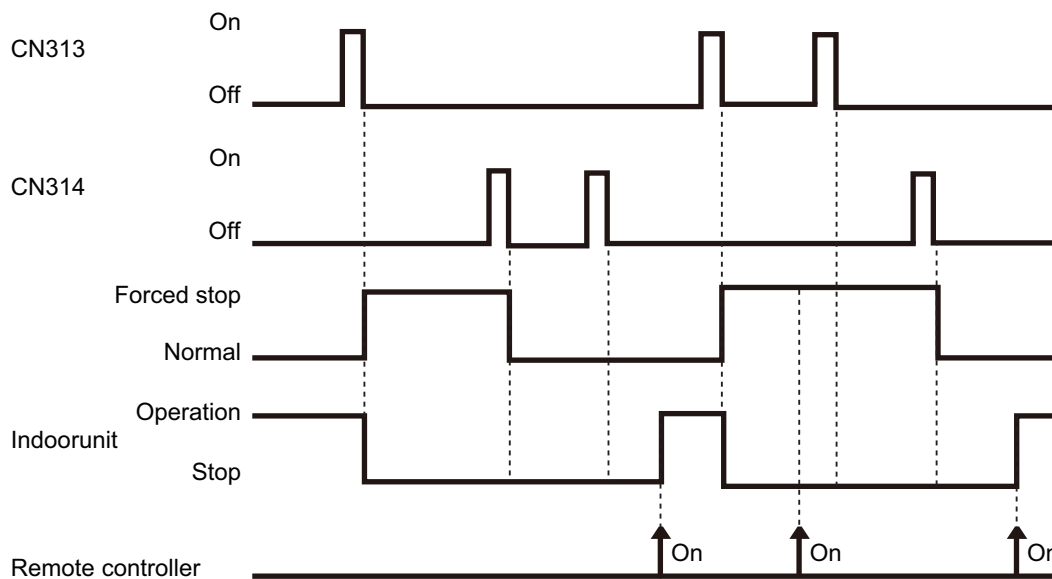

NOTES:

- When the forced stop is triggered, indoor unit stops and Operation/Stop operation by the remote controller is restricted.
- When forced stop function is used with forming a remote controller group, connect the same equipment to each indoor unit within the group.

• When function setting is "Operation/Stop" mode 2

– In the case of "Edge" input:

Function setting /	Rotary SW on External input and output PCB	External input		Input signal	Command
46-03	60-00 / 1	External input and output PCB	CN313	Off → On	Operation
				On → Off	Stop (R.C. disabled)

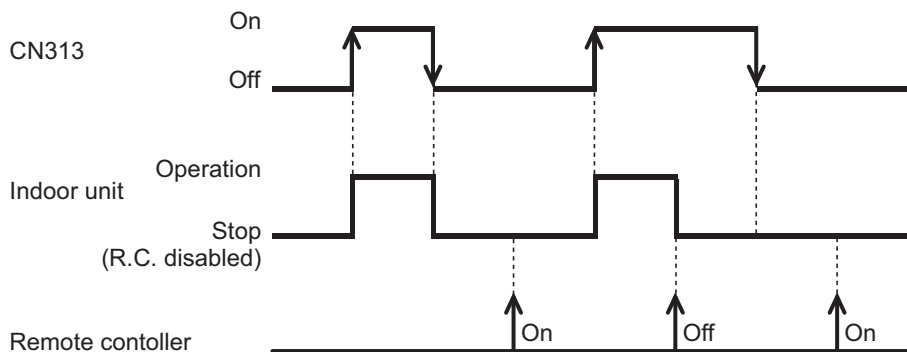

– In the case of "Pulse" input:

Function setting /	Rotary SW on External input and output PCB	External input		Input signal	Command
46-03	60-00 / 1	External input and output PCB	CN313	Pulse	Operation
			CN314	Pulse	Stop (R.C. disabled)

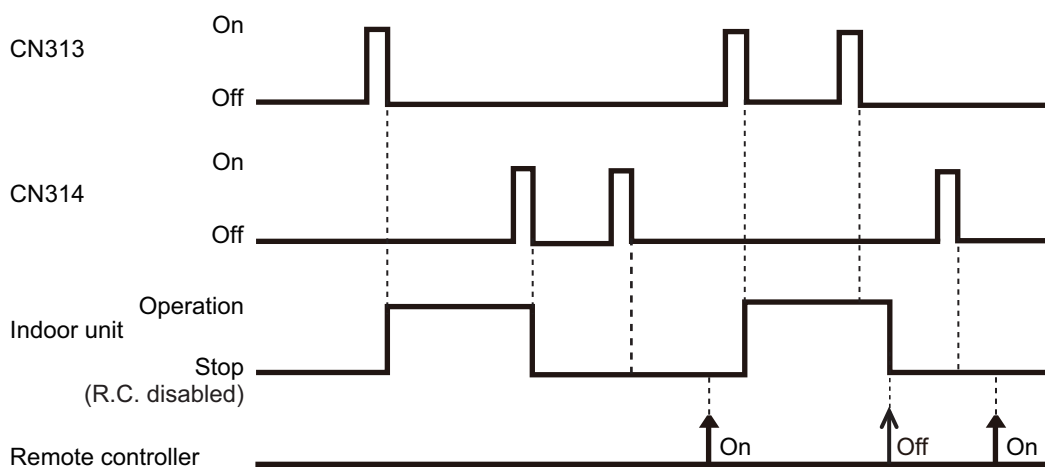

NOTE: When "Operation/Stop" mode 2 function is used with forming a remote controller group, connect the same equipment to each indoor unit within the group.

• Forced thermostat off function

Function setting /	Rotary SW on External input and output PCB	External input		Input signal	Command
	60-00 / 2 60-09 / B 60-10 / C	External input and output PCB	CN313	Off → On	Thermostat off
				On → Off	Normal operation

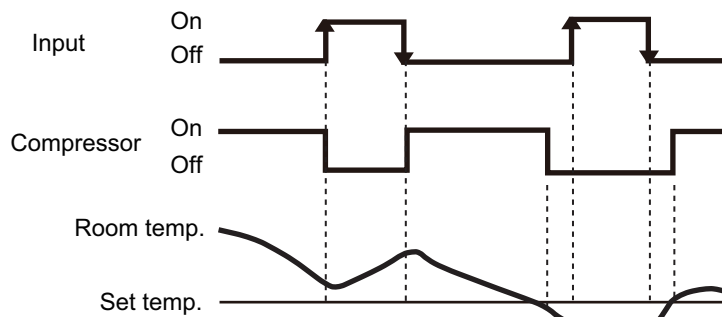

● Control output function

• Operation/Stop status

Function setting /	Rotary SW on External input and output PCB	External output		Output signal	Command
60-00 / 1		External input and output PCB	CN310	Off → On	Operation
				On → Off	Stop

The output is low when the unit is stopped.

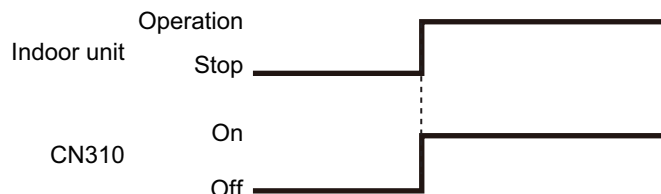

• Error status

Function setting /	Rotary SW on External input and output PCB	External output		Output signal	Command
60-00 / 1		External input and output PCB	CN311	Off → On	Error
				On → Off	Normal

The output is ON when an error is generated for the indoor unit.

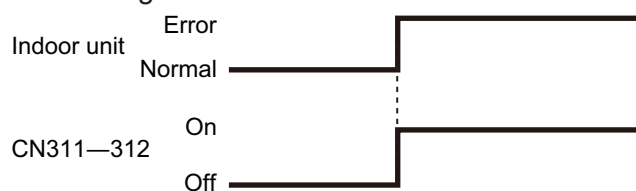

• Indoor unit fan operation status

Function setting /	Rotary SW on External input and output PCB	External output		Output signal	Command
60-00 / 1		External input and output PCB	CN312	Off → On	Fan run
				On → Off	Fan stop

Output signal	Condition
On Low → High	The indoor unit fan is operating.
Off High → Low	The fan is stopped or during cold air prevention. During thermostat off when in dry mode operation.

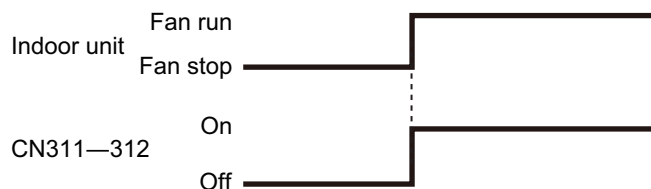

11-3. Wall mounted type (07-14KMTB and KMCC)

With using external input and output functions, this product can be operated inter-connectedly with an external device.

Connector	Input	Output	Remarks
CNA01	Control input	—	See external input/output settings for details.
CNB01	—	Operation status output	
CNB02	—	Error status output	

■ External input

With using external input function, some functions on this product can be controlled from an external device.

- “Operation/Stop” mode can be selected with function setting of indoor unit.
- A twisted pair cable (22AWG) should be used. Maximum length of cable is 150 m.
- The wire connection should be separate from the power cable line.

● Control input (Operation/Stop or Forced stop)

The air conditioner can be remotely operated by means of the following on-site work.

Unit operation is started at the following contents by adding the contact input of a commercial on/off switch to a connector on the external control PCB and turning it on.

Unit operation	Initial setting after power is on	Starting mode other than initial setting
Operation mode	Auto changeover	Mode at previous operation
Set temperature	24 °C	Temperature at previous operation
Airflow mode	AUTO	Mode at previous operation
Air direction (swing)	Standard air direction (swing: off)	Air direction at previous operation

• **Circuit diagram example**

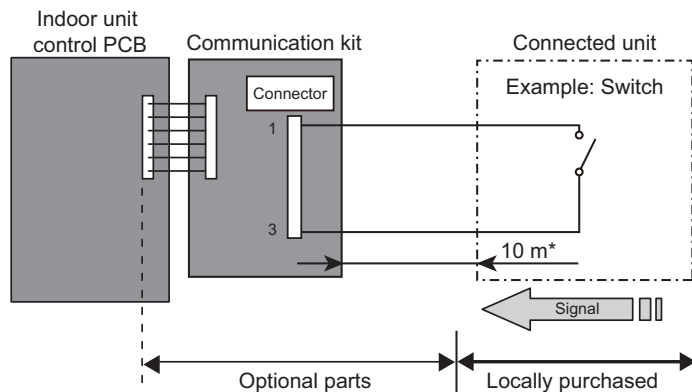

- Contact capacity: DC 24 V or more, 10 mA or more.
- *: Make the distance from the PCB to the connected unit within 10 m.
- Use non-polar relays and switches.

– When function setting is “Operation/Stop” mode

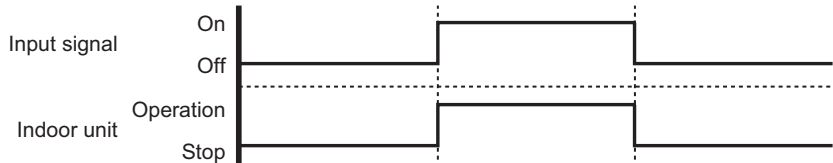

– When function setting is “Forced stop” mode

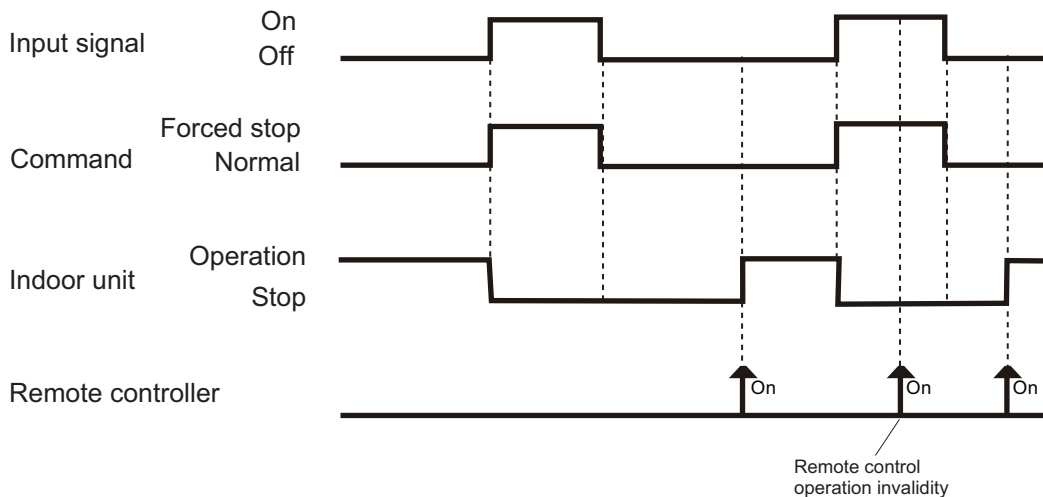

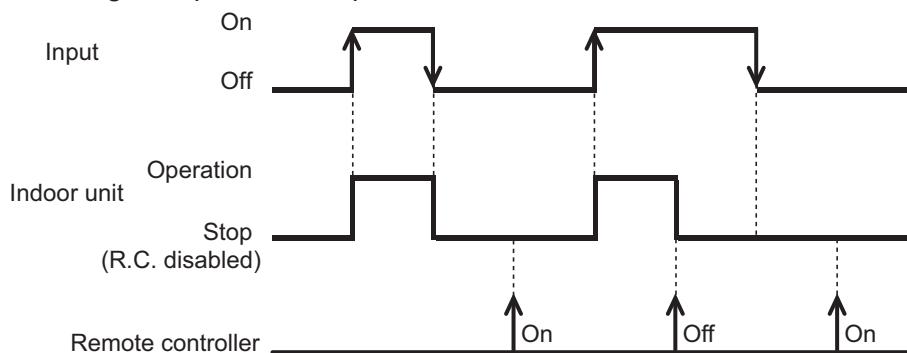

– When function setting is "Operation/Stop" mode 2

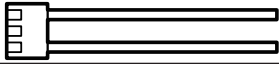

NOTE: When "Operation/Stop" mode 2 function is used with forming a remote controller group, connect the same equipment to each indoor unit within the group.

- Optional part

Part name	Model name	Exterior
External connect kit	UTY-XWZXZ5	External input wire 
Communication kit	UTY-TWBXF2	

* For operating the external function, the wall mounted type requires the communication kit in addition to the wire (UTY-XWZXZ5).

External output

With using external output function, operating status of this product can be transmitted to the external device, and also, this product can be inter-connected with the external device.

● Operation status output

Air conditioner operation status signal can be output.

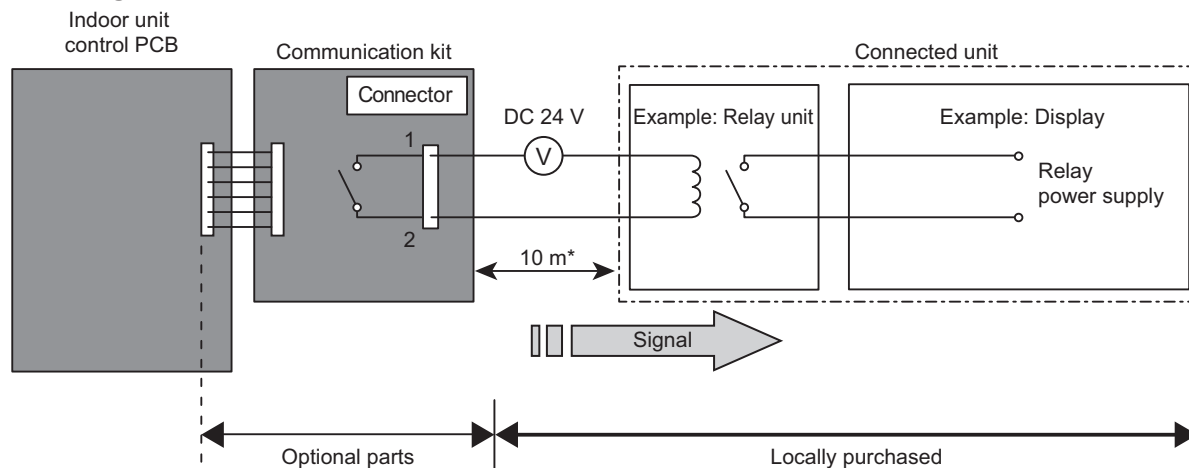

• **Circuit diagram example:**

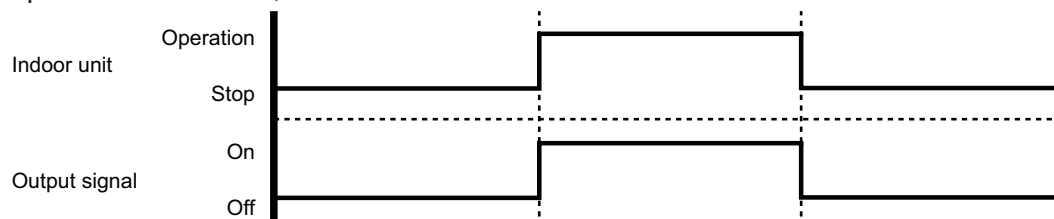

- *: Make the distance from the PCB to the connected unit within 10 m.
- Relay spec: Max. DC 24 V, 10 mA to less than 500 mA.



• **Optional part:**

Part name	Model name	Exterior
External connect kit	UTY-XWZXZ5	External output wire 
Communication kit	UTY-TWBXF2	

* For operating the external function, the wall mounted type requires the communication kit in addition to the wire (UTY-XWZXZ5).

● Error status output

Air conditioner error status signal can be output.

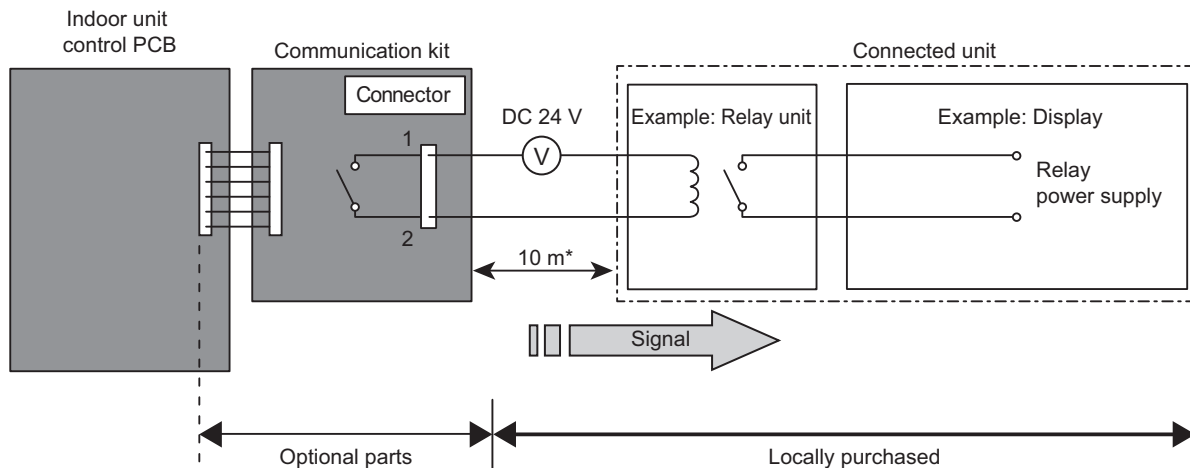

• Circuit diagram example:

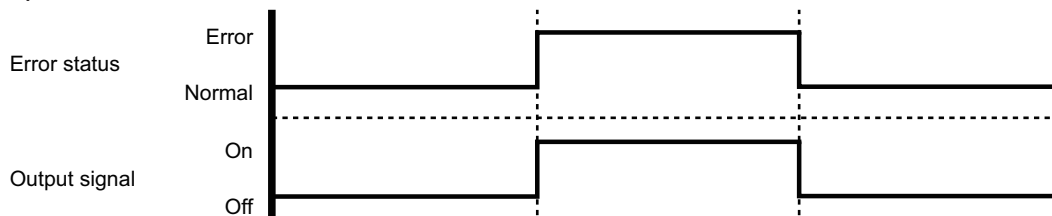

- *: Make the distance from the PCB to the connected unit within 10 m.
- Relay spec: Max. DC 24 V, 10 mA to less than 500 mA.



• Optional part:

Part name	Model name	Exterior
External connect kit	UTY-XWZXZ5	External output wire 
Communication kit	UTY-TWBXF2	

* For operating the external function, the wall mounted type requires the communication kit in addition to the wire (UTY-XWZXZ5).

11-4. Ceiling type

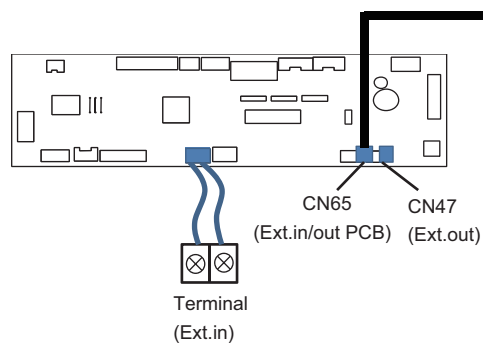

Fig. Indoor unit PCB

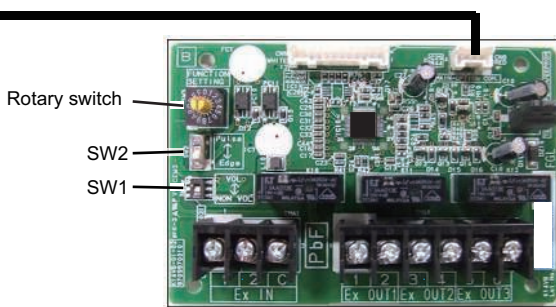

Fig. External input and output PCB

PCB	External input	External output	Connector	Input select	Input signal	External connect kit (Optional parts)
Indoor unit	Operation/Stop Forced stop	—	Terminal	Dry contact	Edge	—
	—	Operation status	CN47	—	—	UTY-XWZXZG
		Error status				
		Indoor unit fan operation status				
External heater output						
External input and output (UTY-XCSX)	Operation/Stop	—	Input 1/ Input 2	Dry contact/ Apply voltage	Edge/ Pulse	—
	Forced thermostat off		Input 1		Edge	
	—	Operation status	Output 1 Output 2 Output 3	—	—	—
		Error status				
Indoor unit status						
External heater output						

External input

With using external input function, some functions on this product can be controlled from an external device.

- “Operation/Stop” mode can be selected with function setting of indoor unit.
- A twisted pair cable (22AWG) should be used. Maximum length of cable is 150 m.
- The wire connection should be separate from the power cable line.

Indoor unit

Indoor unit functions such as Operation/Stop can be done by using indoor unit terminals.

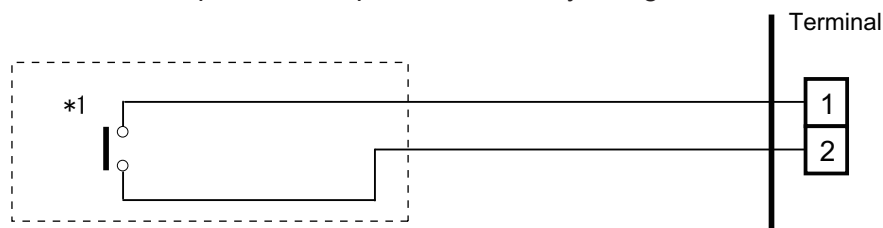

*1: The switch can be used on the following condition: DC 12 V to 24 V, 1 mA to 15 mA.

● External input and output PCB

The indoor unit Operation/Stop can be set by using the input terminal on the PCB.

● Input select

Use either one of these types of terminals according to the application. (Both types of terminals cannot be used simultaneously.)

- Dry contact

In case of internal power supply, set the slide switch of SW1 to "NON VOL" side.

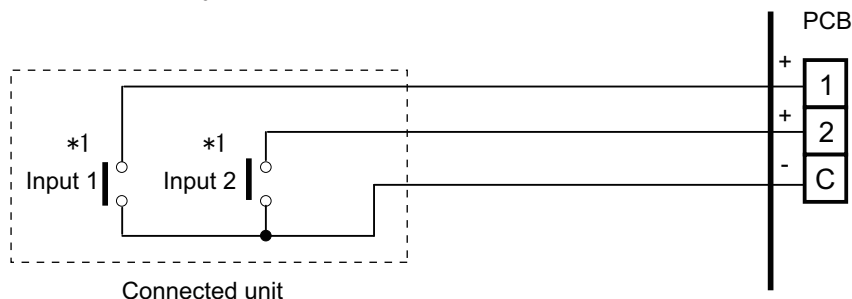

*1: The switches can be used on the following condition: DC 12 V to 24 V, 1 mA to 15 mA.

- Apply voltage

In case of external power supply, set the slide switch of SW1 to "VOL" side.

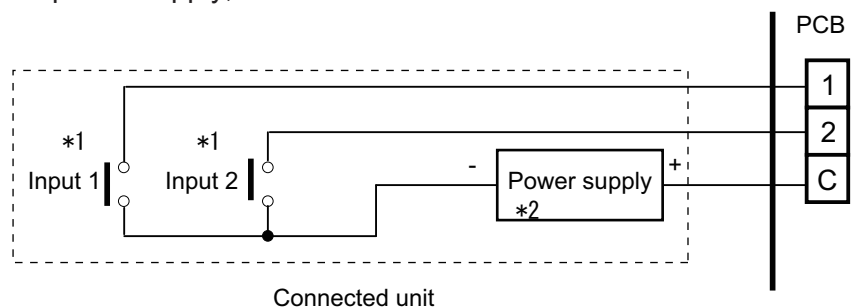

*1: The switches can be used on the following condition: DC 12 V to 24 V, 1 mA to 15 mA.

*2: Make the power supply DC 12 V to 24 V 10 mA or more.

External output

Use an external output cable with appropriate external dimension, depending on the number of cables to be installed.

Indoor unit

- A twisted pair cable (22AWG) should be used. Maximum length of cable is 25 m.
- Output voltage: High DC 12 V \pm 2 V, Low 0 V.
- Permissible current: 50 mA
- For details, refer to Chapter 11-4-3. "[Combination of external input and output](#)" on page 174.

When indicator, etc. are connected directly

Example: Function setting 60 is set to "00"

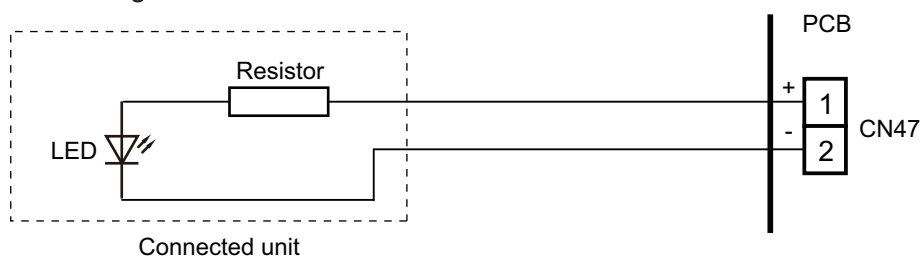

When connecting with a device equipped with a power supply

Example: Function setting 60 is set to "00"

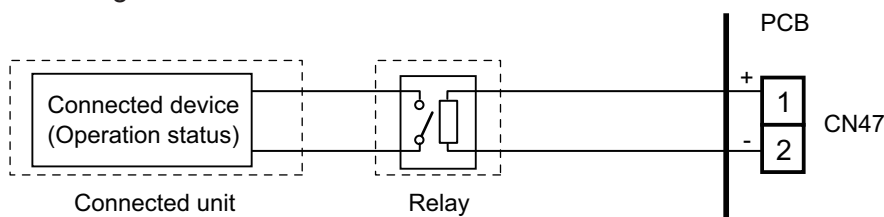

External input and output PCB

- A twisted pair cable (22AWG) should be used.
- Permissible voltage and current: DC 5 V to 30 V / 3 A, AC 30 V to 250 V / 3 A
- For details, refer to Chapter 11-4-3. "[Combination of external input and output](#)" on page 174.

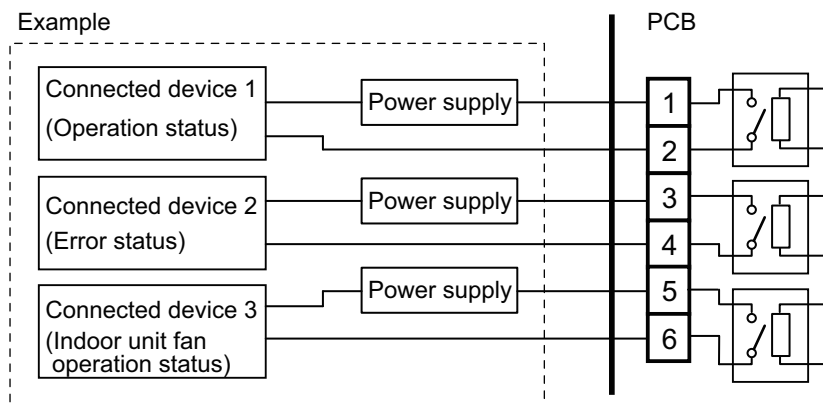

■ Combination of external input and output

By combining the function setting of the indoor unit and rotary switch setting of the External input and output PCB, you can select various combinations of functions.

Combination examples of external input and output are as follows:

Mode	Function setting	External input and output PCB (Rotary SW)	External input			
			Indoor unit Input	External input and output PCB		
			Terminal	Input 1	Input 2	Signal type
0-1	60-00	1	Operation/Stop	Operation/Stop	Not available	Edge
				Operation	Stop	Pulse
0-2	60-00	2	Operation/Stop	Forced Thermostat OFF	Not available	Edge
1—8	60-01 to 60-08	3 - 9, A	(Setting prohibited)			
9	60-09	B	Operation/Stop	Forced Thermostat OFF	Not available	Edge
10	60-10	C	Operation/Stop	Forced Thermostat OFF	Not available	Edge
11	60-11	D	Operation/Stop	Forced Thermostat OFF	Not available	Edge

Mode	Function setting	External input and output PCB (Rotary SW)	External output			
			Indoor unit Output	External input and output PCB		
			CN47	Output 1	Output 2	Output 3
0-1	60-00	1	Operation/Stop	Operation/Stop	Error status	Indoor unit fan operation status
0-2	60-00	2	Operation/Stop	Error status	Indoor unit fan operation status	External heater output
1—8	60-01 to 60-08	3 - 9, A	(Setting prohibited)			
9	60-09	B	Error status	Operation/Stop	Indoor unit fan operation status	External heater output
10	60-10	C	Indoor unit fan operation status	Operation/Stop	Error status	External heater output
11	60-11	D	External heater output	Operation/Stop	Indoor unit fan operation status	Error status

NOTE: Input of Operation/Stop depends on the setting of function setting 46.

00: Operation/Stop mode 1 (R.C. enabled)

01: (Setting prohibited)

02: Forced stop

03: Operation/Stop mode 2 (R.C. disabled)

● Input signal type

- Indoor unit
Input signal type is only "Edge".

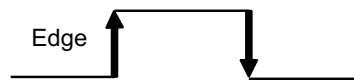

- External input and output PCB
The input signal type can be selected.

Signal type (edge or pulse) can be switched by the DIP switch 2 (SW2) on the External input and output PCB.

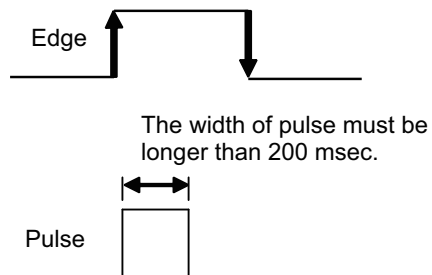

■ Details of function

● Control input function

- When function setting is "Operation/Stop" mode 1
 - In the case of "Pulse" input

Function setting /	Rotary SW of External input and output PCB	External input		Input signal	Command
		External input and output PCB	Input 1	Pulse	Operation
46-00	60-00 / 1		Input 1	Pulse	Operation
			Input 2	Pulse	Stop

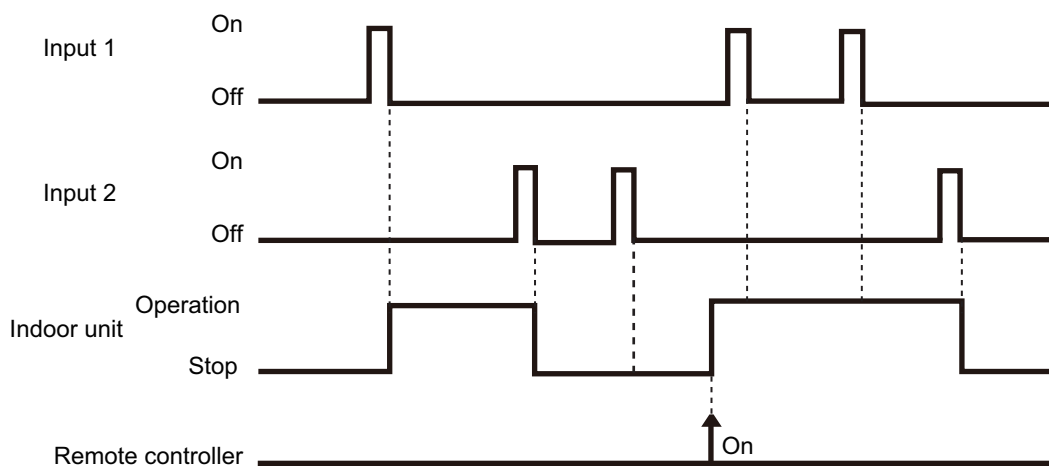

NOTES:

- The last command has priority.
- The indoor units within the same remote controller group operates in the same mode.

- When function setting is "Forced stop" mode
 - In the case of "Edge" input

Function setting /	Rotary SW of External input and output PCB	External input		Input signal	Command
46-02	-	Input of indoor unit	Terminal	Off → On	Forced stop
				On → Off	Normal
	60-00 / 1	External input and output PCB	Input 1	Off → On	Forced stop
				On → Off	Normal

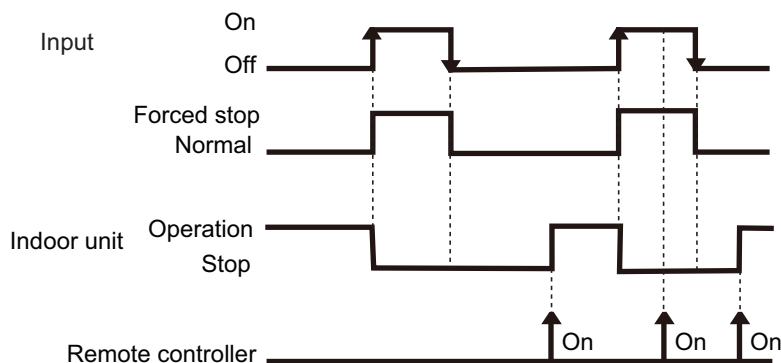

- In the case of "Pulse" input

Function setting /	Rotary SW of External input and output PCB	External input		Input signal	Command
46-02	60-00 / 1	External input and output PCB	Input 1	Pulse	Forced stop
			Input 2	Pulse	Normal

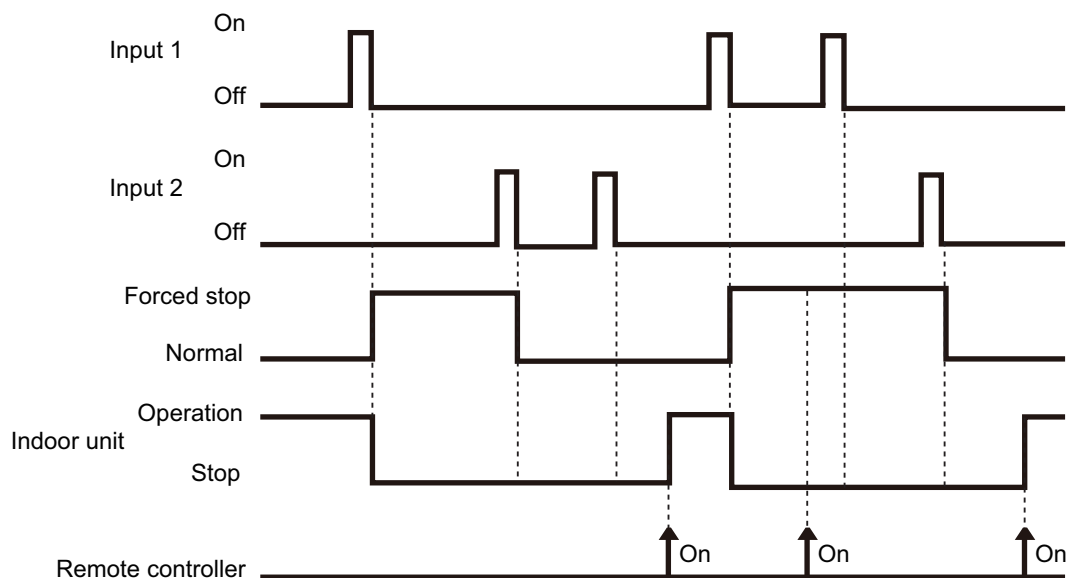

NOTES:

- When the forced stop is triggered, indoor unit stops and Operation/Stop operation by the remote controller is restricted.
- When forced stop function is used with forming a remote controller group, connect the same equipment to each indoor unit within the group.

- When function setting is "Operation/Stop" mode 2
 - In the case of "Edge" input

Function setting /	Rotary SW of External input and output PCB	External input		Input signal	Command
46-03	-	Input of indoor unit	Terminal	Off → On	Operation
				On → Off	Stop (R.C. disabled)
	60-00 / 1	External input and output PCB	Input 1	Off → On	Operation
				On → Off	Stop (R.C. disabled)

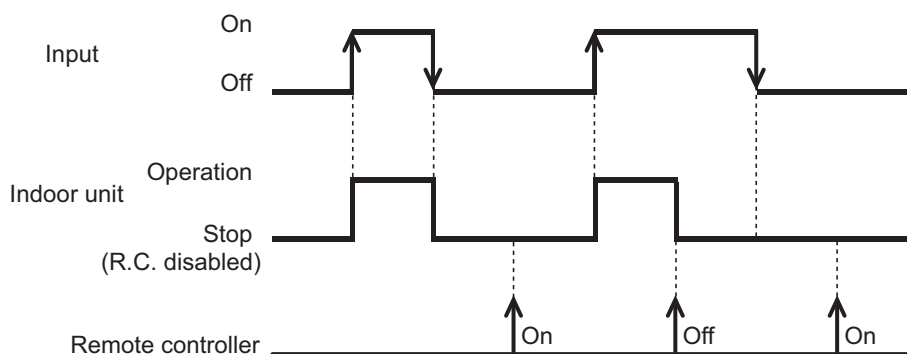

- In the case of "Pulse" input

Function setting /	Rotary SW of External input and output PCB	External input		Input signal	Command
46-03	60-00 / 1	External input and output PCB	Input 1	Pulse	Operation
			Input 2	Pulse	Stop (R.C. disabled)

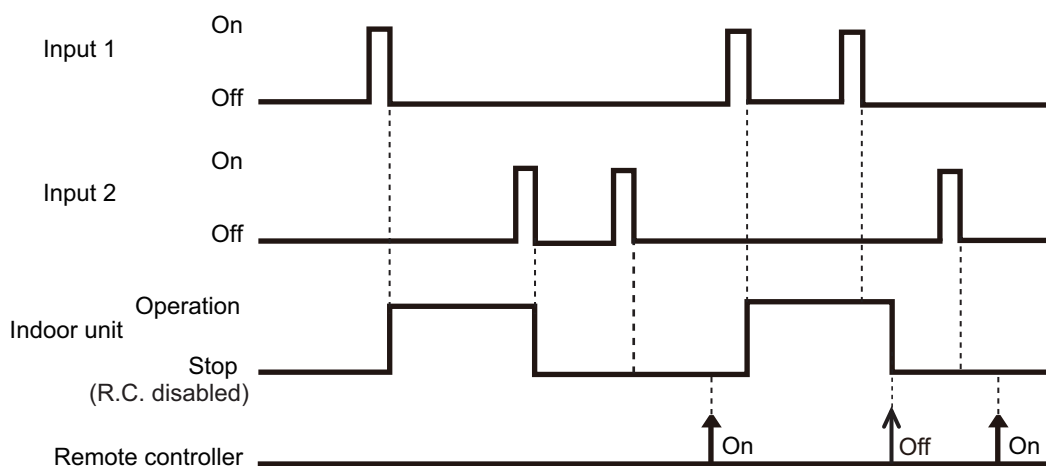

NOTES:

- When "Operation/Stop" mode 2 function is used with forming a remote controller group, connect the same equipment to each indoor unit within the group.

● Forced thermostat off function

Function setting /	Rotary SW of External input and output PCB	External input		Input signal	Command
	60-00 / 2 60-09 / B 60-10 / C 60-11 / D	External input and output PCB	Input 1	Off → On	Thermostat off
				On → Off	Normal operation

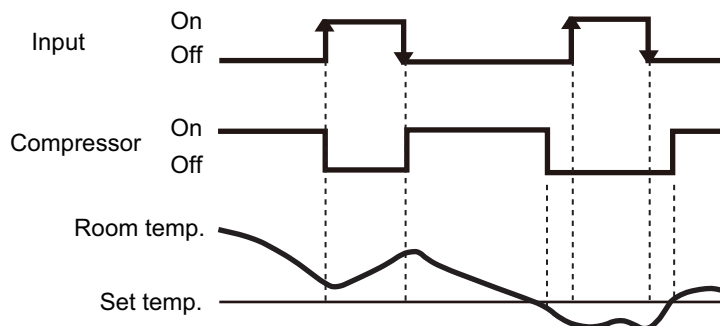

● Control output function

Function setting /	Rotary SW of External input and output PCB	External output		Output signal	Command
	60-00 / 1, 2	Output of indoor unit	CN47	Low → High	Operation
				High → Low	Stop
	60-00 / 1 60-09 / B 60-10 / C 60-11 / D	External input and output PCB	Output 1	Off → On	Operation
				On → Off	Stop

The output is low when the unit is stopped.

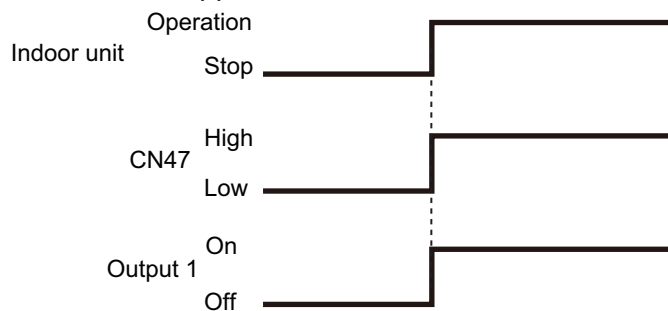

● Error status

Function setting /	Rotary SW of External input and output PCB	External output		Output signal	Command
60-09 / B		Output of indoor unit	CN47	Low → High	Error
				High → Low	Normal
60-00 / 2	External input and output PCB		Output 1	Off → On	Error
				On → Off	Normal
60-00 / 1 60-10 / C			Output 2	Off → On	Error
				On → Off	Normal
60-11 / D			Output 3	Off → On	Error
				On → Off	Normal

The output is ON when an error is generated for the indoor unit.

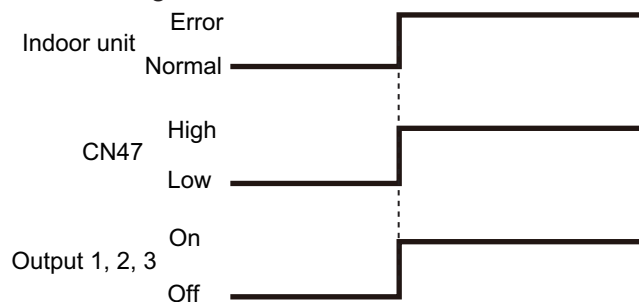

● Indoor unit fan operation status

Function setting /	Rotary SW of External input and output PCB	External output		Output signal	Command	
60-10 / C		Output of indoor unit	CN47	Low → High	Fan run	
				High → Low	Fan stop	
60-00 / 2 60-09 / B	External input and output PCB		Output 2	Off → On	Fan run	
				On → Off	Fan stop	
60-11 / D			Output 3	Off → On	Fan run	
				On → Off	Fan stop	
60-00 / 1						

Output signal	Condition
On Low → High	The indoor unit fan is operating.
Off High → Low	The fan is stopped or during cold air prevention. During thermostat off when in dry mode operation.

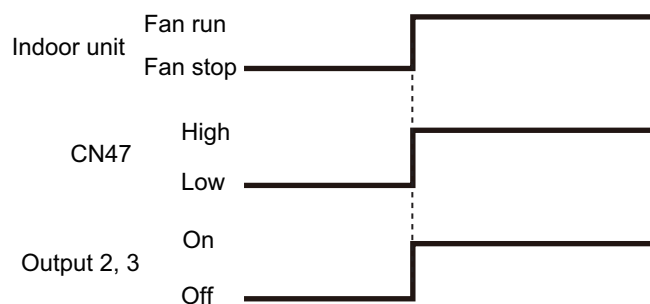

● External heater output

Function setting /	Rotary SW of External input and output PCB	External output		Output signal	Command
	60-11 / D	Output of indoor unit	CN47	Low → High	Heater on
				High → Low	Heater off
	60-00 / 2 60-09 / B 60-10 / C	External input and output PCB	Output 3	Off → On	Heater on
				On → Off	Heater off

Output signal	Condition
Low → High Off → On	Heater turns on as shown in diagram of heating temperature
High → Low On → Off	Heater turns off as shown in diagram of heating temperature <ul style="list-style-type: none"> • Other than Heating mode • Error occurred • Forced thermo off • Fan stop protection

Specifications of the signal output performance are as shown as follows:

Example: When set temperature (T_s) is set at 22 °C;

- And room temperature (T_r) increase above 12 °C, signal output is on.
- And T_r increase above 21 °C, signal output is off.
- And T_r decrease below 19 °C, signal output is on.
- And T_r decrease below 10 °C, signal output is off.

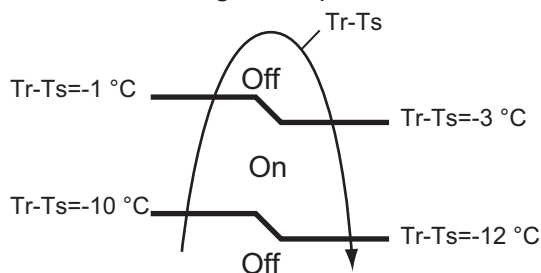

The output also turns off in defrost operation.

11-5. Floor type

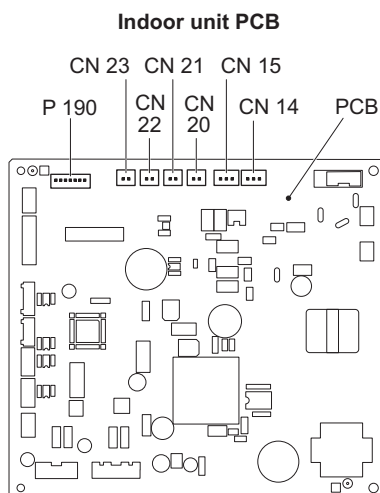

PCB	External input	External output	Connector	Input signal
Indoor unit	Operation/Stop	—	CN14	Edge
	Forced stop		CN15	
	Forced thermostat off			
	—	Operation status	CN20/CN21/ CN22/CN23	—
	Error status			
	Indoor unit fan operation status			
	External heater output			

External input

With using external input function, some functions on this product can be controlled from an external device.

- “Operation/Stop” mode can be selected with function setting of indoor unit.
- A twisted pair cable (22AWG) should be used. Maximum length of cable is 150 m.
- The wire connection should be separate from the power cable line.

Indoor unit

Indoor unit functions such as Operation/Stop can be done by using indoor unit connectors.

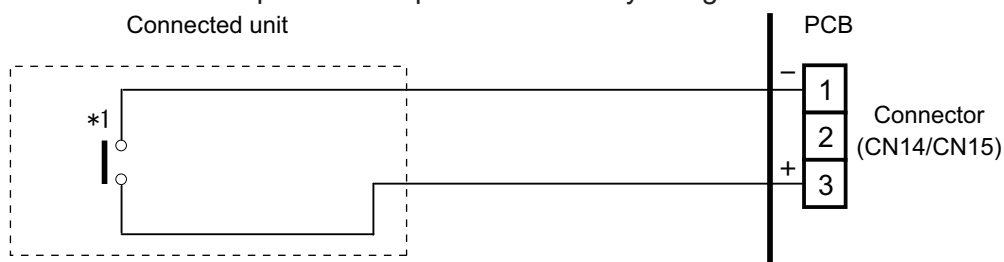

*1: The switch can be used on the following condition: DC 12 V to 24 V, 1 mA to 15 mA.

External output

Use an external output cable with appropriate external dimension, depending on the number of cables to be installed.

Indoor unit

- A twisted pair cable (22AWG) should be used. Maximum length of cable is 25 m .
- Output voltage: High DC 12 V \pm 2 V, Low 0 V.
- Permissible current: 50 mA
- For details, refer to Chapter 11-5-3. "[Combination of external input and output](#)" on page 184.

When indicator or other components are connected directly

Example: Function setting 60 is set to "00"

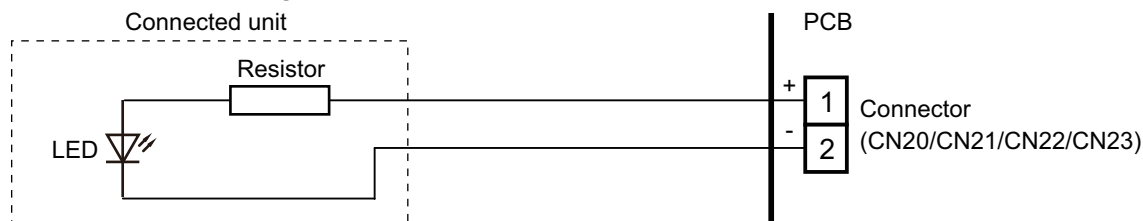

When connecting with a device equipped with a power supply

Example: Function setting 60 is set to "00"

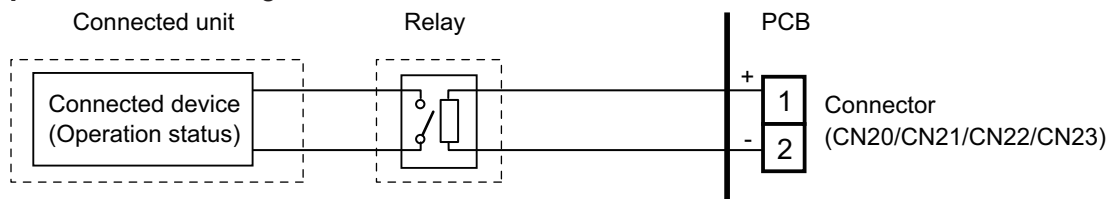

■ Combination of external input and output

By combining the function setting of the indoor unit, you can select various combinations of functions.

Combination examples of external input and output are as follows:

Mode	Function setting	External input	
		Indoor unit	
		CN14	CN15
0	60-00	Operation/Stop (Function setting 46-00) or Forced stop (Function setting 46-02)	Forced thermostat Off
9	60-09		Forced thermostat Off
10	60-10		Forced thermostat Off
11	60-11		Forced thermostat Off
12	60-12		Forced thermostat Off

Mode	Function setting	External output			
		Indoor unit			
		CN20	CN21	CN22	CN23
0	60-00	Operation/Stop	Error status	Indoor unit fan operation status	External heater output
9	60-09	Error status	Operation/Stop	Indoor unit fan operation status	External heater output
10	60-10	Indoor unit fan operation status	Operation/Stop	Error status	External heater output
11	60-11	External heater output	Operation/Stop	Indoor unit fan operation status	Error status

NOTE: Input of Operation/Stop depends on the setting of function setting 46.

00: Operation/Stop mode 1 (R.C. enabled)

01: (Setting prohibited)

02: Forced stop

03: Operation/Stop mode 2 (R.C. disabled)

● Input signal type

• Indoor unit

Input signal type is only "Edge".

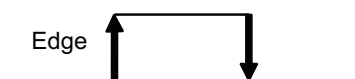

■ Details of function

● Control input function

- When function setting is "Operation/Stop" mode 1
 - In the case of "Edge" input

Mode	Function setting		External input	Input signal	Command	
0	46-00	—	Input of indoor unit	CN14	Off → On	Operation
					On → Off	Stop
	60-00	CN15		Off → On	Operation	
				On → Off	Stop	

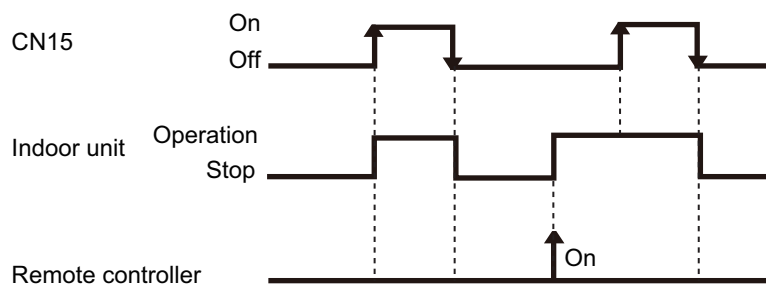

- When function setting is "Forced stop" mode
 - In the case of "Edge" input

Mode	Function setting		External input	Input signal	Command	
0	46-02	—	Input of indoor unit	CN14	Off → On	Forced stop
					On → Off	Normal
	60-00	CN15		Off → On	Forced stop	
				On → Off	Normal	

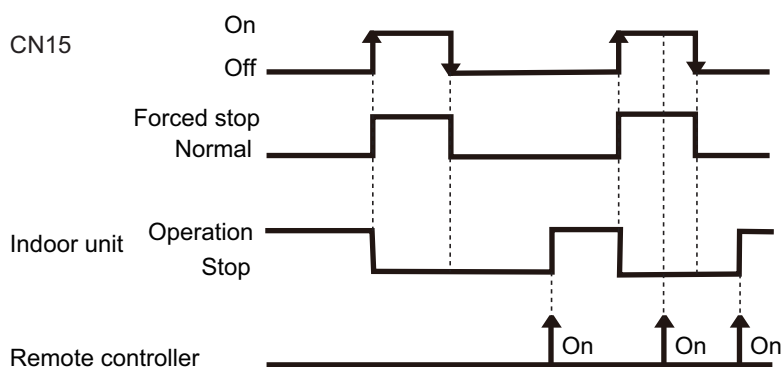

- When function setting is "Operation/Stop" mode 2
 - In the case of "Edge" input

Mode	Function setting		External input	Input signal	Command	
0	46-03	—	Input of indoor unit	CN14	Off → On	Operation
				CN14	On → Off	Stop (R.C. disabled)
	60-00	CN15		Off → On	Operation	
		CN15		On → Off	Stop (R.C. disabled)	

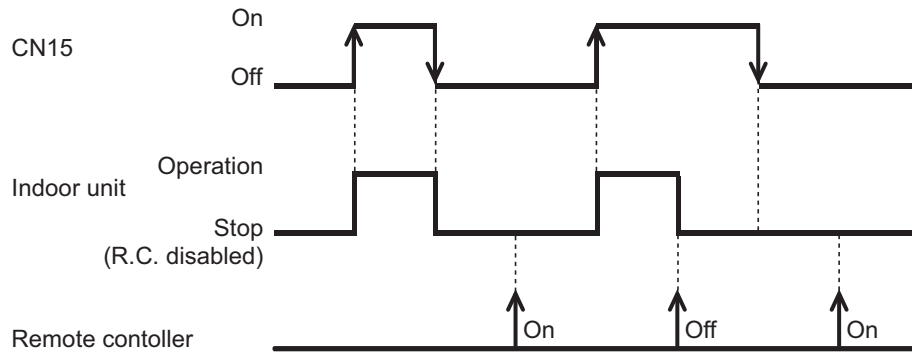

● Control output function

• Operation/Stop status

Mode	Function setting	External output		Output signal	Command
0	60-00	Output of indoor unit	CN15	Low → High	Operation
				High → Low	Stop
0	60-00		CN20	Off → On	Operation
				On → Off	Stop

The output is low when the unit is stopped.

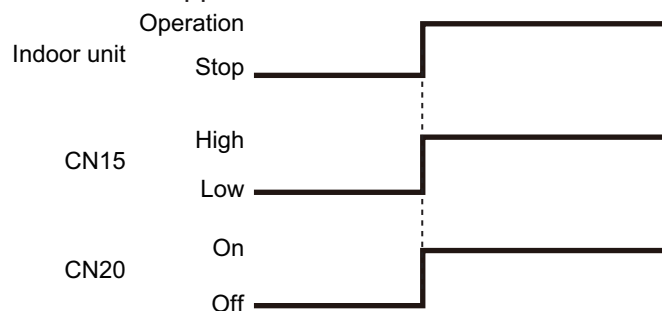

• Error status

Mode	Function setting	External output		Output signal	Command
9	60-09	Output of indoor unit	CN15	Low → High	Error
				High → Low	Normal
0	60-00		CN21	Off → On	Error
				On → Off	Normal

The output is ON when an error is generated for the indoor unit.

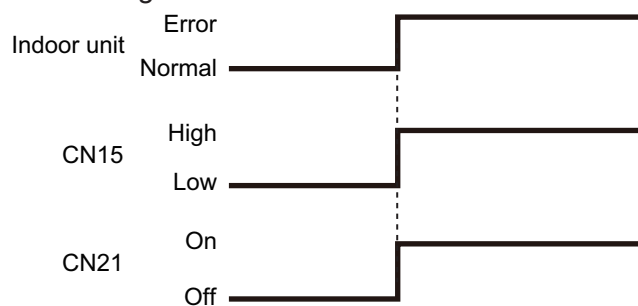

- Indoor unit fan operation status

Mode	Function setting	External output		Output signal	Command
10	60-10	Output of indoor unit	CN15	Low → High	Fan run
				High → Low	Fan stop
0	60-00	Output of indoor unit	CN22	Off → On	Fan run
				On → Off	Fan stop

Output signal	Condition
On Low → High	The indoor unit fan is operating.
Off High → Low	The fan is stopped or during cold air prevention. During thermostat off when in dry mode operation.



- Set point attainment status

NOTE: This function is valid only when function setting 96 is set to "01" (Primary unit) or "02" (Secondary unit).

When the room temperature does not reach the set point at a room due to the lower cooling performance caused by external factor such as the outdoor temperature change, signal is output to tell the attainment status of set point.

Mode	Function setting	External output		Output signal	Command
12	60-12	Output of indoor unit	CN15	On → Off	Normal
				Off → On	Set point attainment

Output signal	Condition
Off	Reached the set point. ($T_r \leq T_{s\alpha} + 0.5^\circ\text{C}$)
On	Unreached the set point. ($T_r > T_{s\alpha} + 2.5^\circ\text{C}$) However, even if the set point unreached, the signal will not be output for 7 minutes after power is turned on.

When performing the server room control, both of the primary unit and secondary unit output the set point attainment status if any of the unit is outputting alternative operation command.

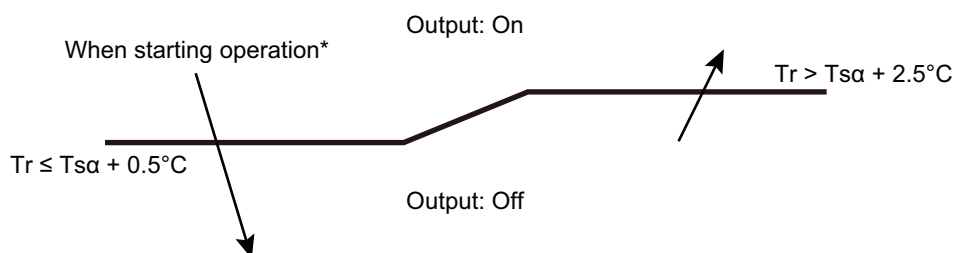

*: When starting operation or resetting, judges the zone to descending direction.

● External heater output

• Installation configuration of individual connection

External heating device is installed individually. (No use of indoor unit fan)

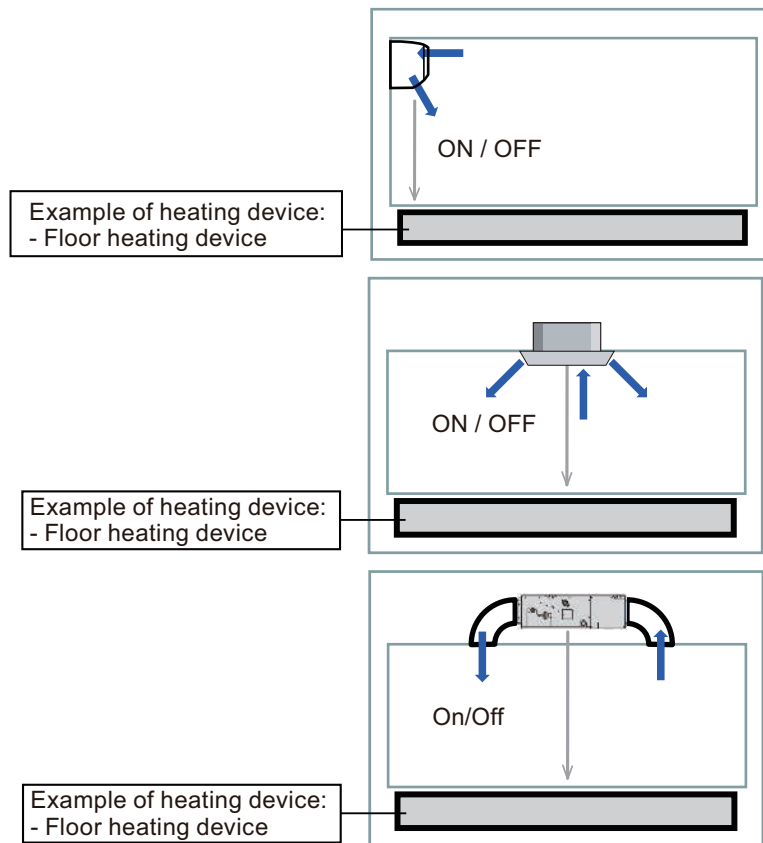

⚠ WARNING

- Design and install external heater appropriately with considering its protection.
- Inappropriate designing and installation of external heater may cause a fire by emitted heat from the external heater.
- Fujitsu General Ltd. is not responsible for inappropriate designing or installation of external heating device.

• Auxiliary heater control 1

Operation	Condition
Heater on	Heater is on as shown in following diagram of heating temperature.
Heater off	<ul style="list-style-type: none"> • Heater is off as shown in following diagram of heating temperature. • Other than heating mode • Error occurred • Forced thermostat off • Fan stop protection

- Temperature of heater on (Thon): Adjustable by function number 62 (Operating temperature switching of external heaters).
- All control temperatures will shift by adjusting "Thon".

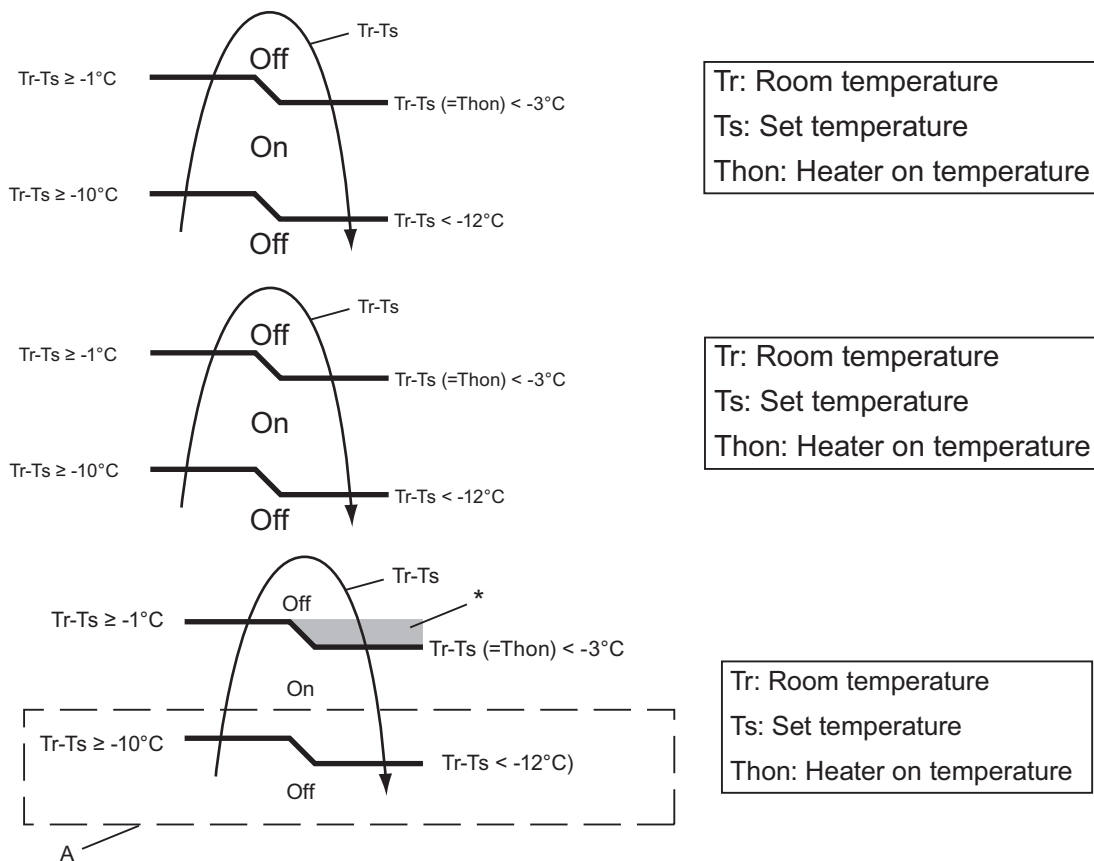

*: When room temperature stays in this zone for a specific time, auxiliary heater is turned on. For details, refer to function number 71.

Example: When set temperature (Ts) is 22°C (Factory setting),

- and room temperature (Tr) increases above 12°C, signal output is on.
- and room temperature (Tr) increases above 21°C, signal output is off.
- and room temperature (Tr) decreases below 19°C, signal output is on.
- and room temperature (Tr) decreases below 10°C, signal output is off.

12. Group connection

NOTE: Group control cannot be used together with Wireless LAN adapter.

Installation procedure for group control system:

A number of indoor units can be operated at the same time using a single remote controller.

NOTE: When different type of indoor units (such as wall mounted type and cassette type, cassette type and duct type, or other combinations) are connected using group control system, some functions may no longer be available.

1. Connect up to 16 indoor units in a system.

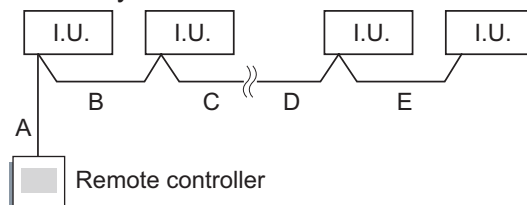

A, B, C, D, E: Remote controller cable	
Wiring length limitation	$A + B + C + D + E \leq 500 \text{ m}$

Example of wiring method

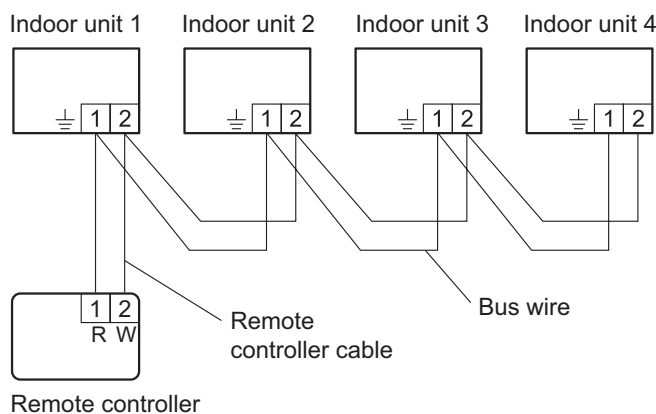

Example of wiring method

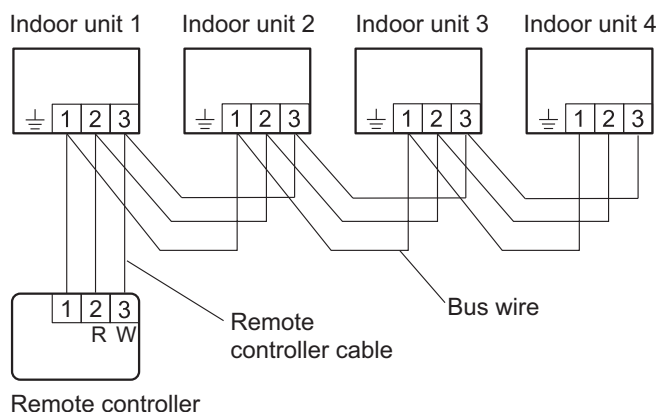

2. Set the R.C. address. (Function setting)

- Addresses will be automatically set when initially starting up this unit. In such a case, do not change the remote controller address for the indoor unit, and keep it at the initial setting of "00".
- Only set addresses manually when using different numbers for addresses.
Set the R.C. address of each indoor unit using the function setting. (Refer to "Remote controller address setting" in "[Contents of function setting](#)" on page 268.)

NOTES:

- Do not use the same setting value.
- Setting is reflected after the power is turned on again.

Also set the R.C. address for the remote controller. For details, refer to the remote controller installation manual.

NOTE: In manual setting, connect up to 15 indoor units in a system.

Example of wiring method

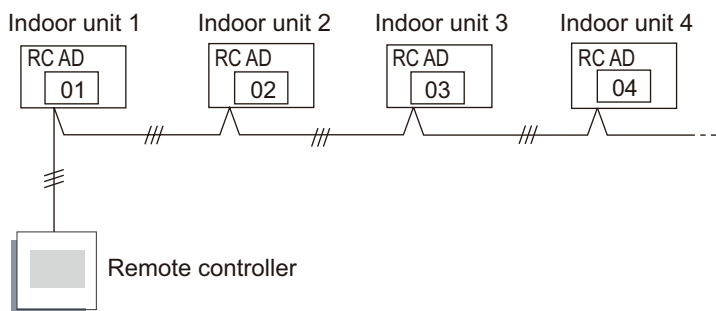

13. Remote controller

13-1. Wireless remote controller (AR-REW4E, AR-REM4E, and AR-REB1E)

Overview

- AR-REW4E

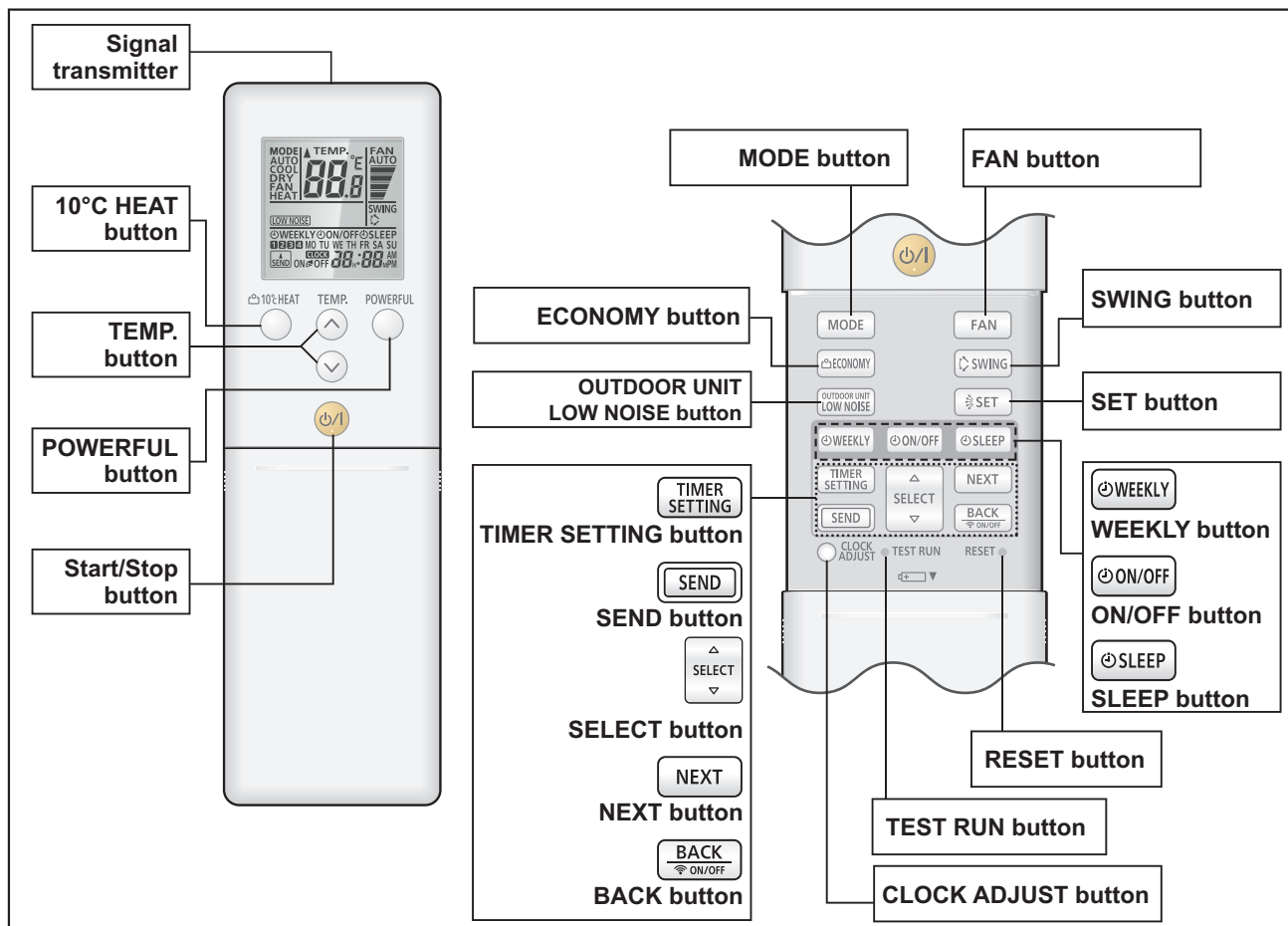

NOTE: Functions may differ by type of the indoor unit. For details, refer to the operation manual.

Display panel

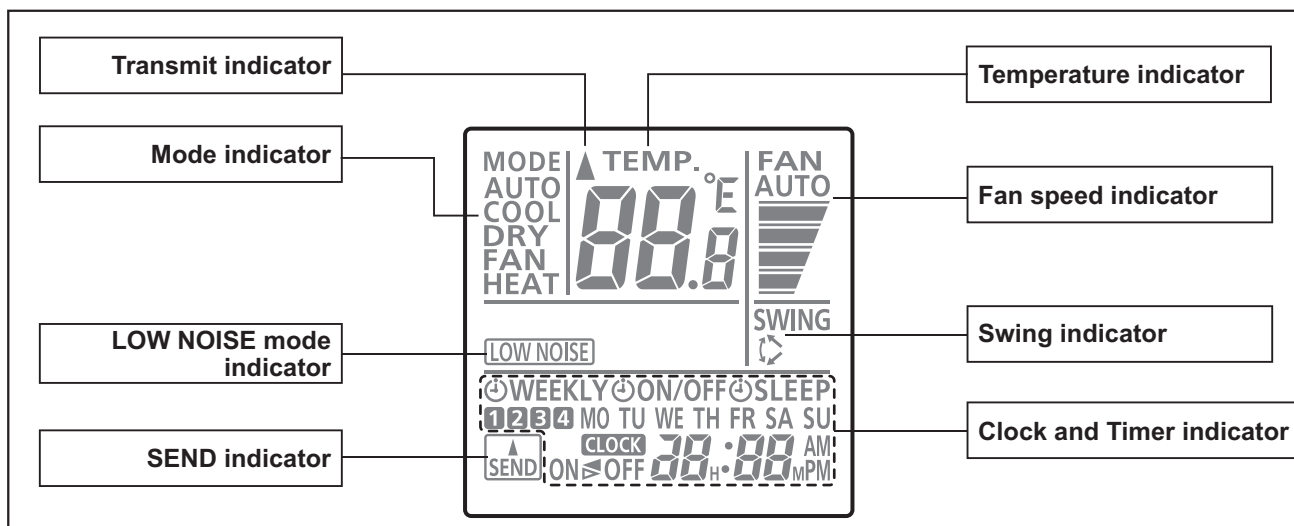

To facilitate explanation, the accompanying illustration has been drawn to show all possible indicators; in actual operation, however, the display will only show those indicators appropriate to the current operation.

• AR-REM4E

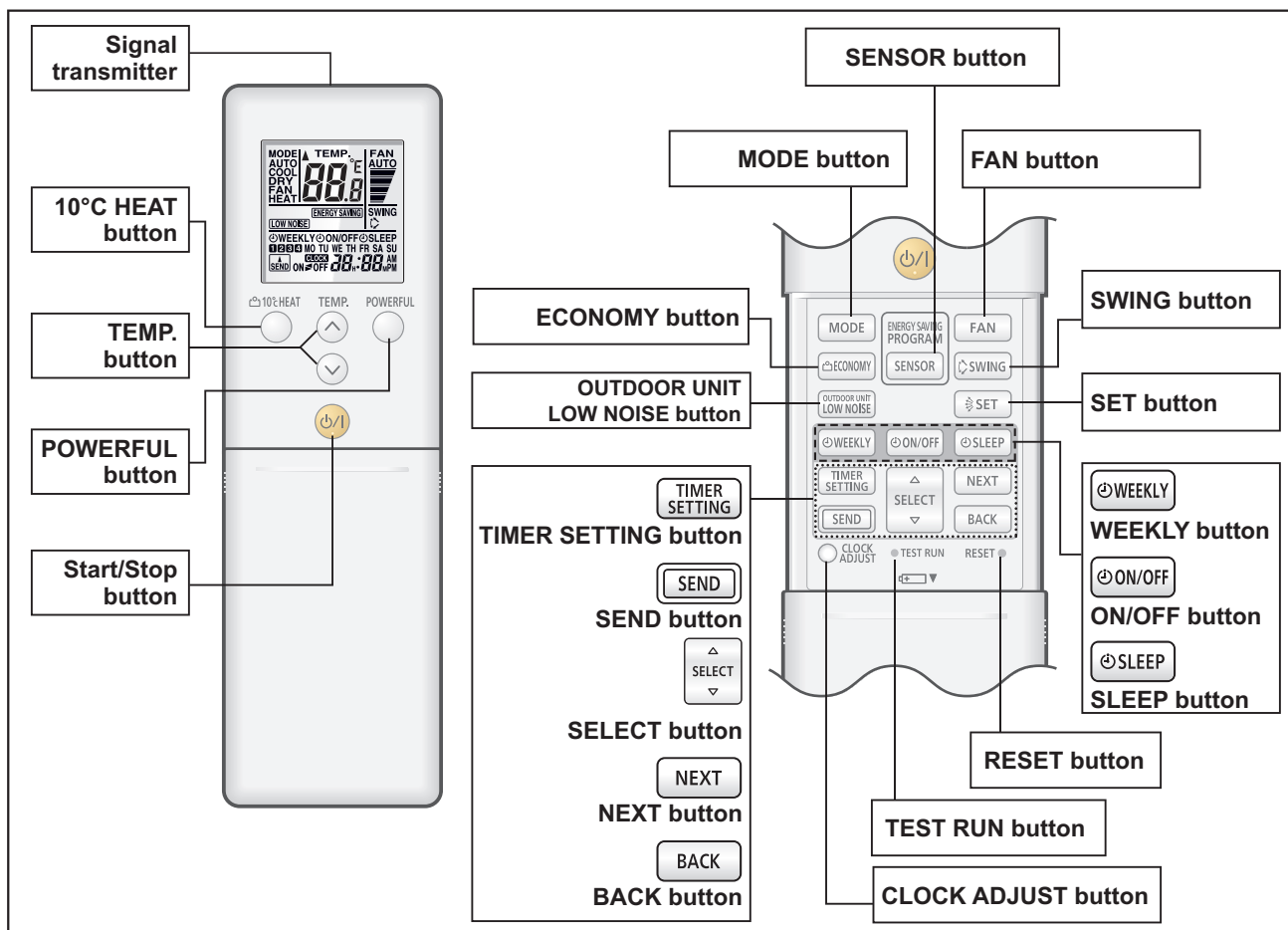

NOTE: Functions may differ by type of the indoor unit. For details, refer to the operation manual.

Display panel

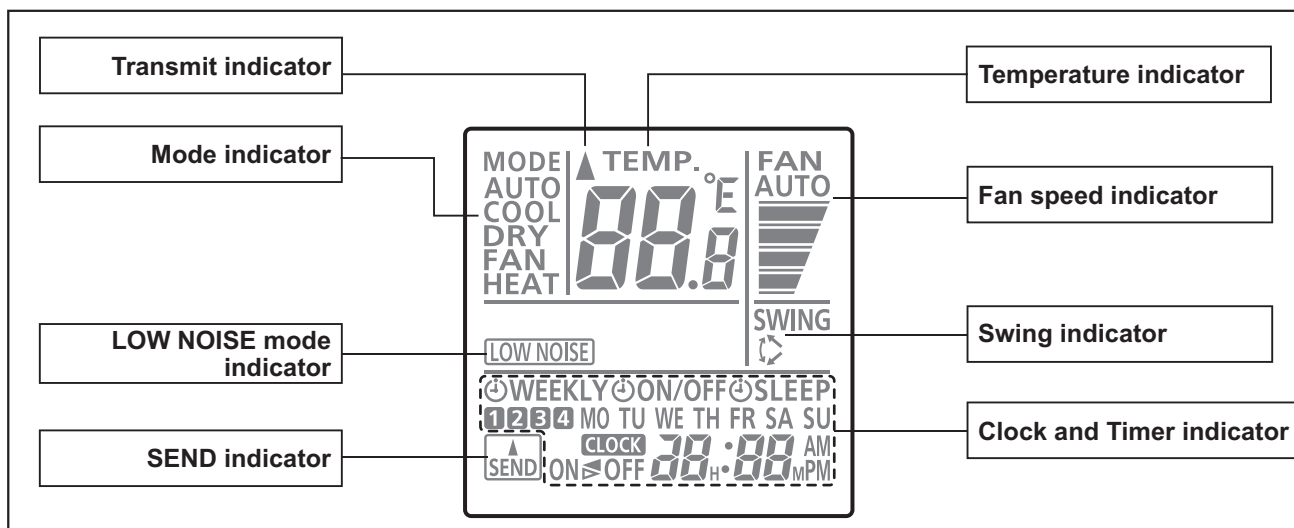

To facilitate explanation, the accompanying illustration has been drawn to show all possible indicators; in actual operation, however, the display will only show those indicators appropriate to the current operation.

• AR-REB1E

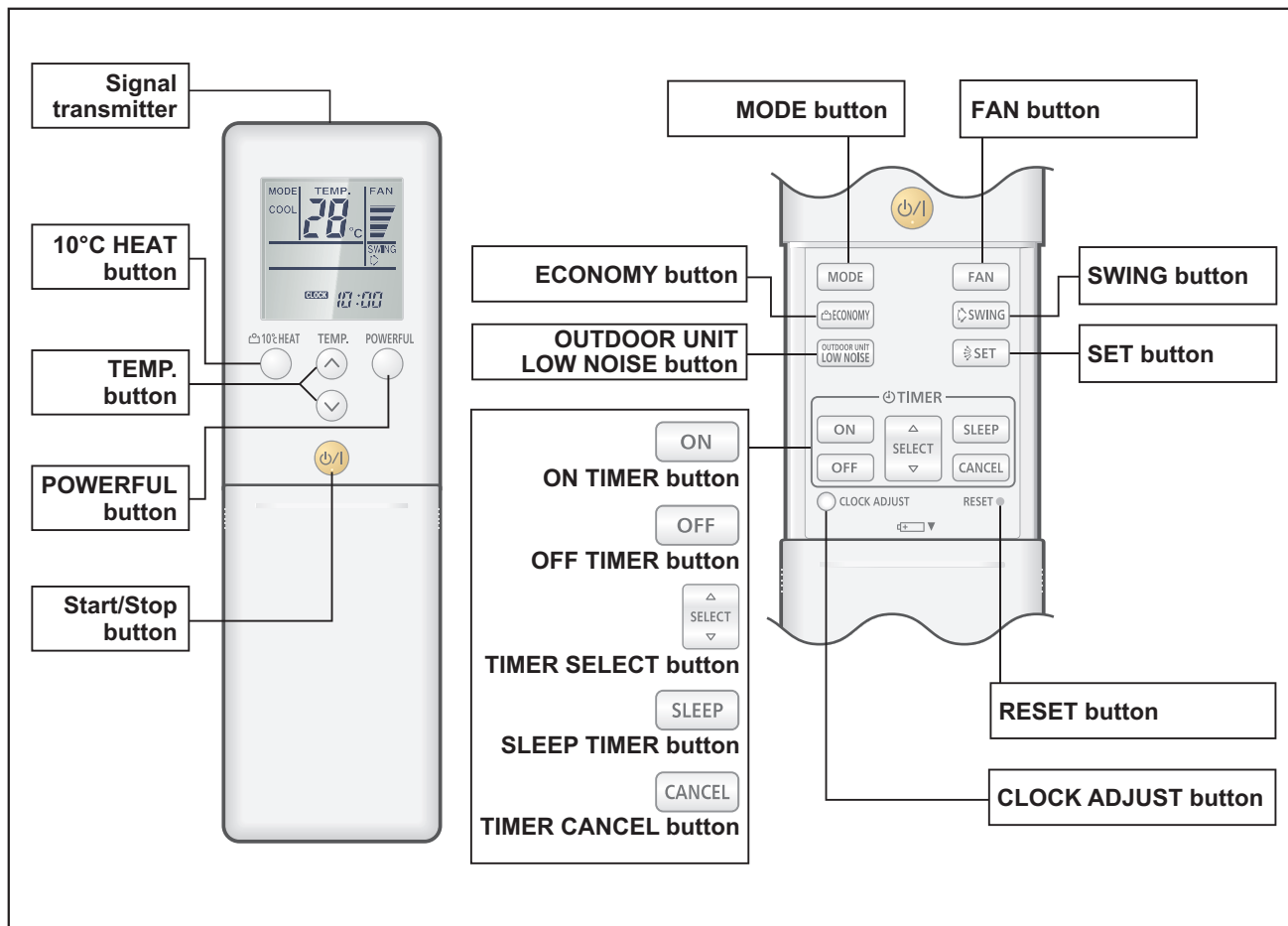

NOTE: Functions may differ by type of the indoor unit. For details, refer to the operation manual.

Display panel

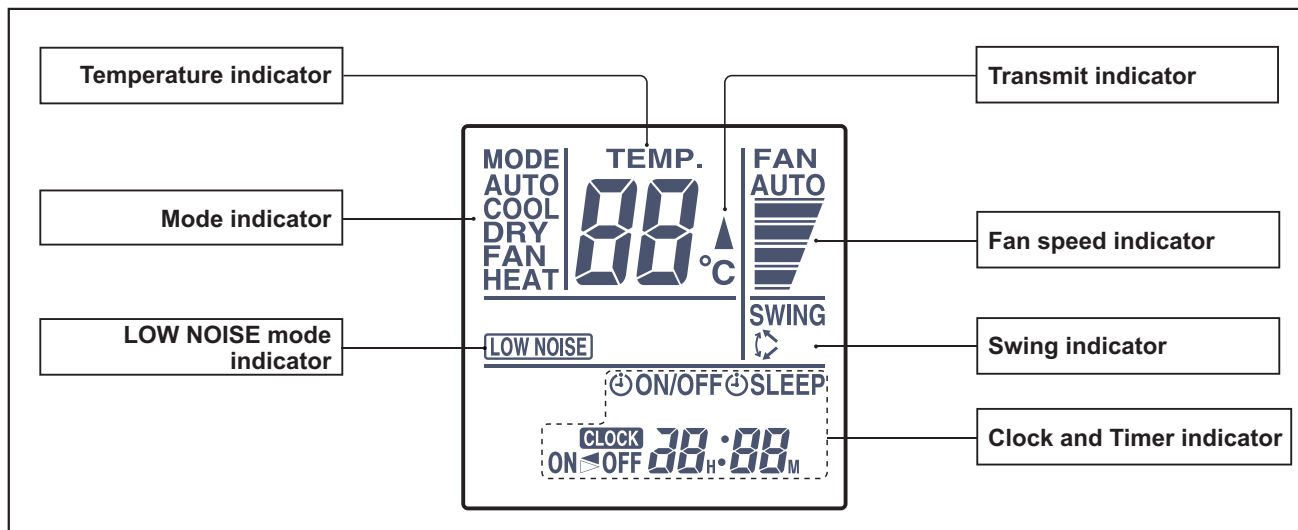

To facilitate explanation, the accompanying illustration has been drawn to show all possible indicators; in actual operation, however, the display will only show those indicators appropriate to the current operation.

■ Specifications

● Controller

Unit: mm

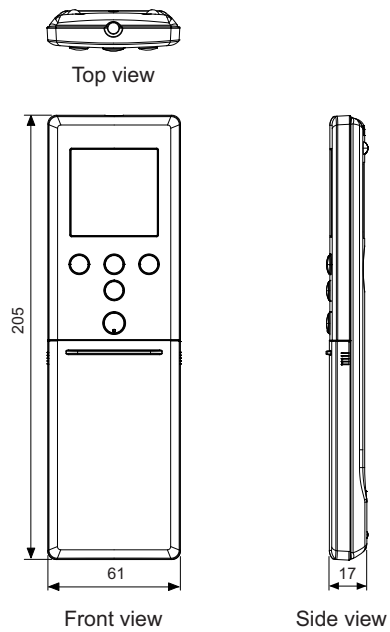

Size (H × W × D)	mm	205 × 61 × 17
Weight	g	124 (without batteries)

● Holder

Unit: mm

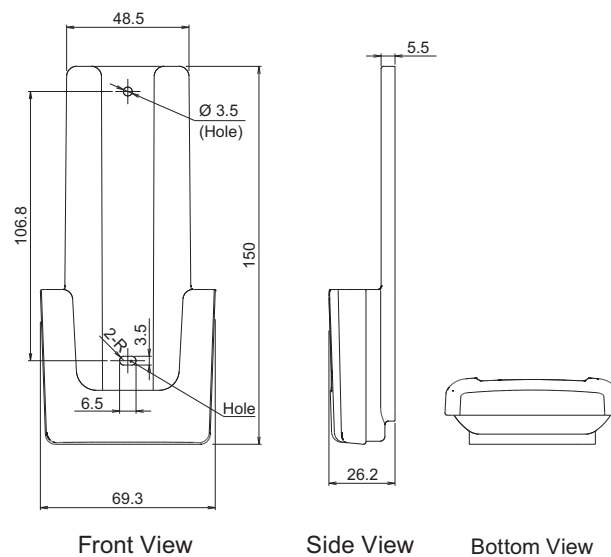

Size (H × W × D)	mm	150 × 69.3 × 26.2
Weight	g	27

13-2. Wireless remote controller (AR-REW2E)

Overview

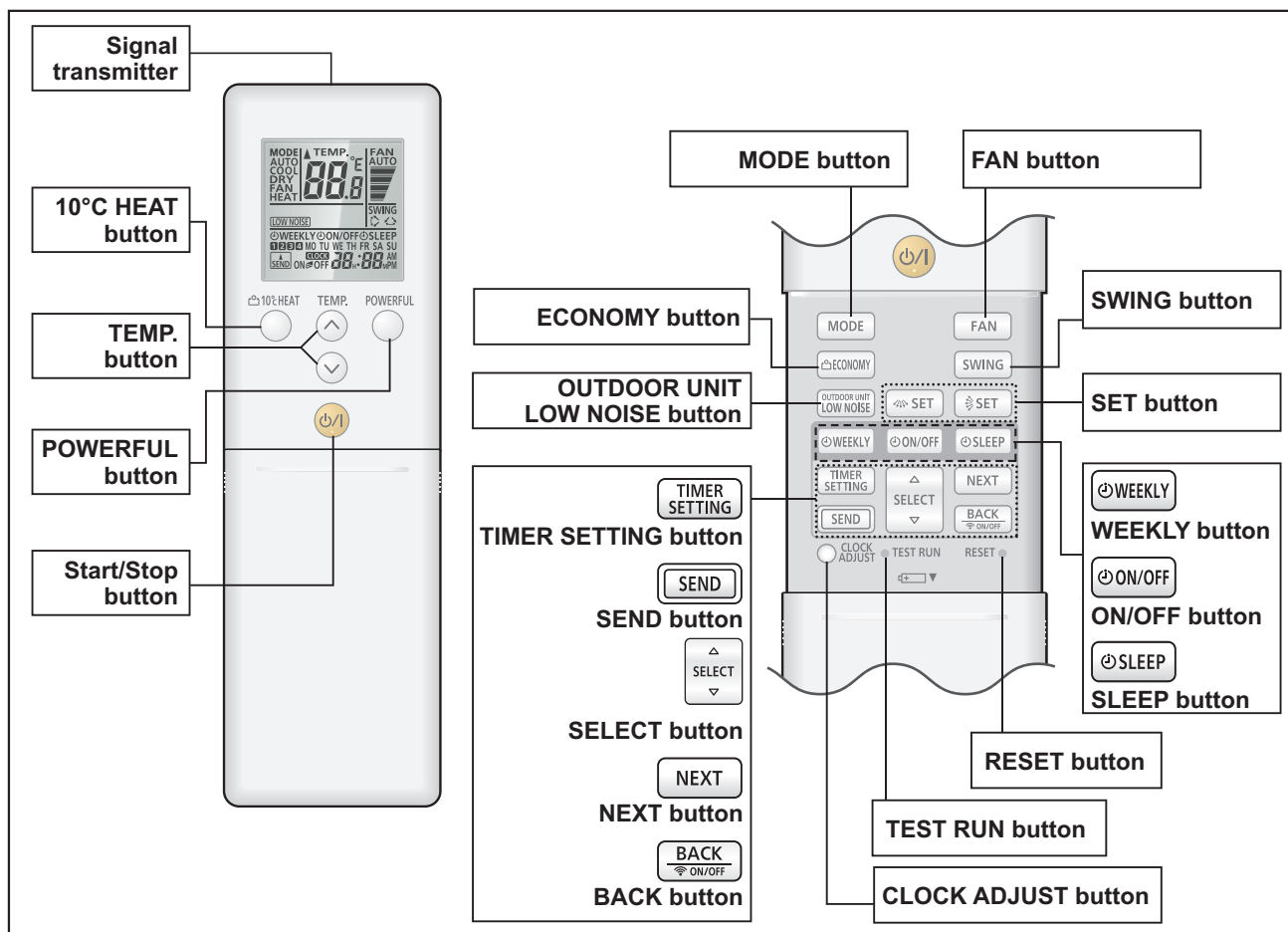

NOTE: Functions may differ by type of the indoor unit. For details, refer to the operation manual.

Display panel

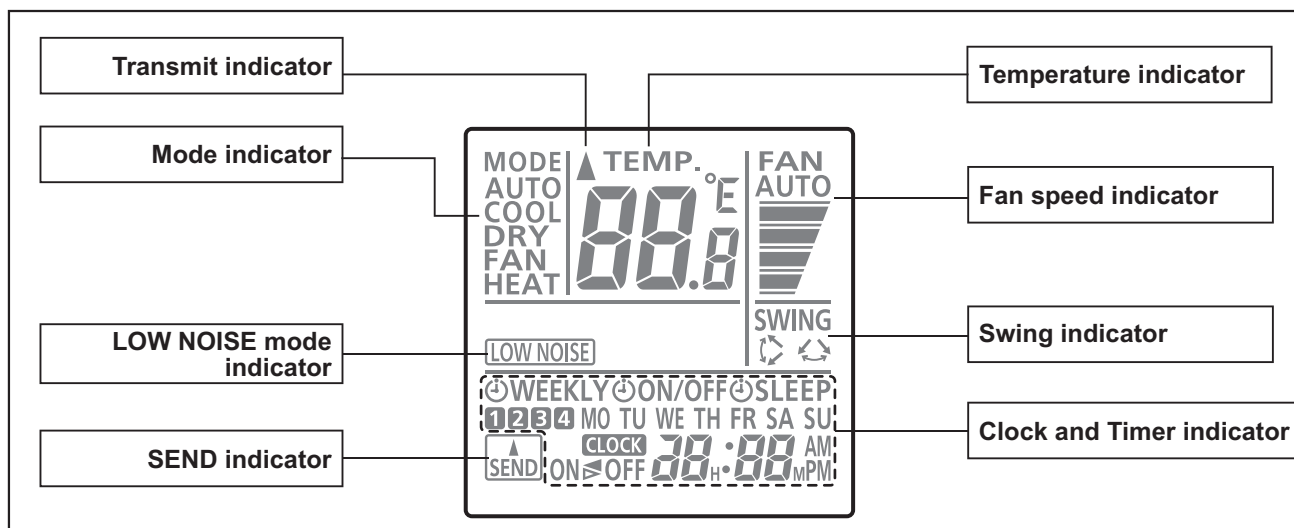

To facilitate explanation, the accompanying illustration has been drawn to show all possible indicators; in actual operation, however, the display will only show those indicators appropriate to the current operation.

Specifications

Controller

Unit: mm

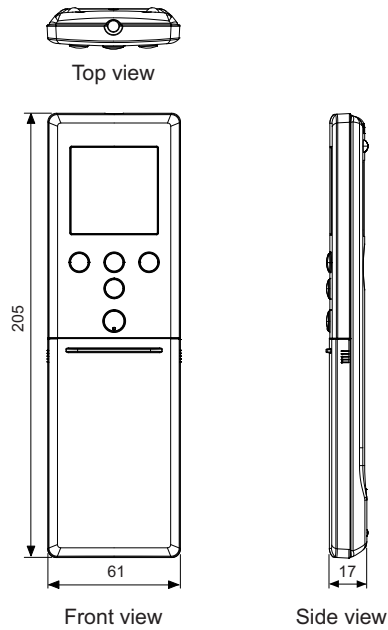

Size (H × W × D)	mm	205 × 61 × 17
Weight	g	125 (without batteries)

Holder

Unit: mm

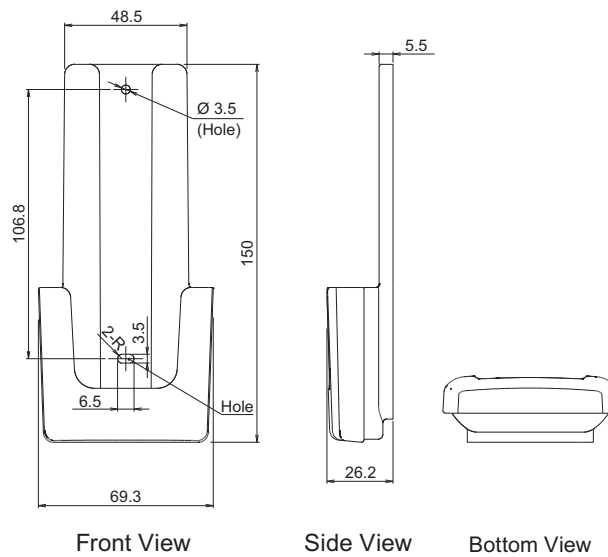

Size (H × W × D)	mm	150 × 69.3 × 26.2
Weight	g	27

13-3. Wireless remote controller (AR-REM7E)

Overview

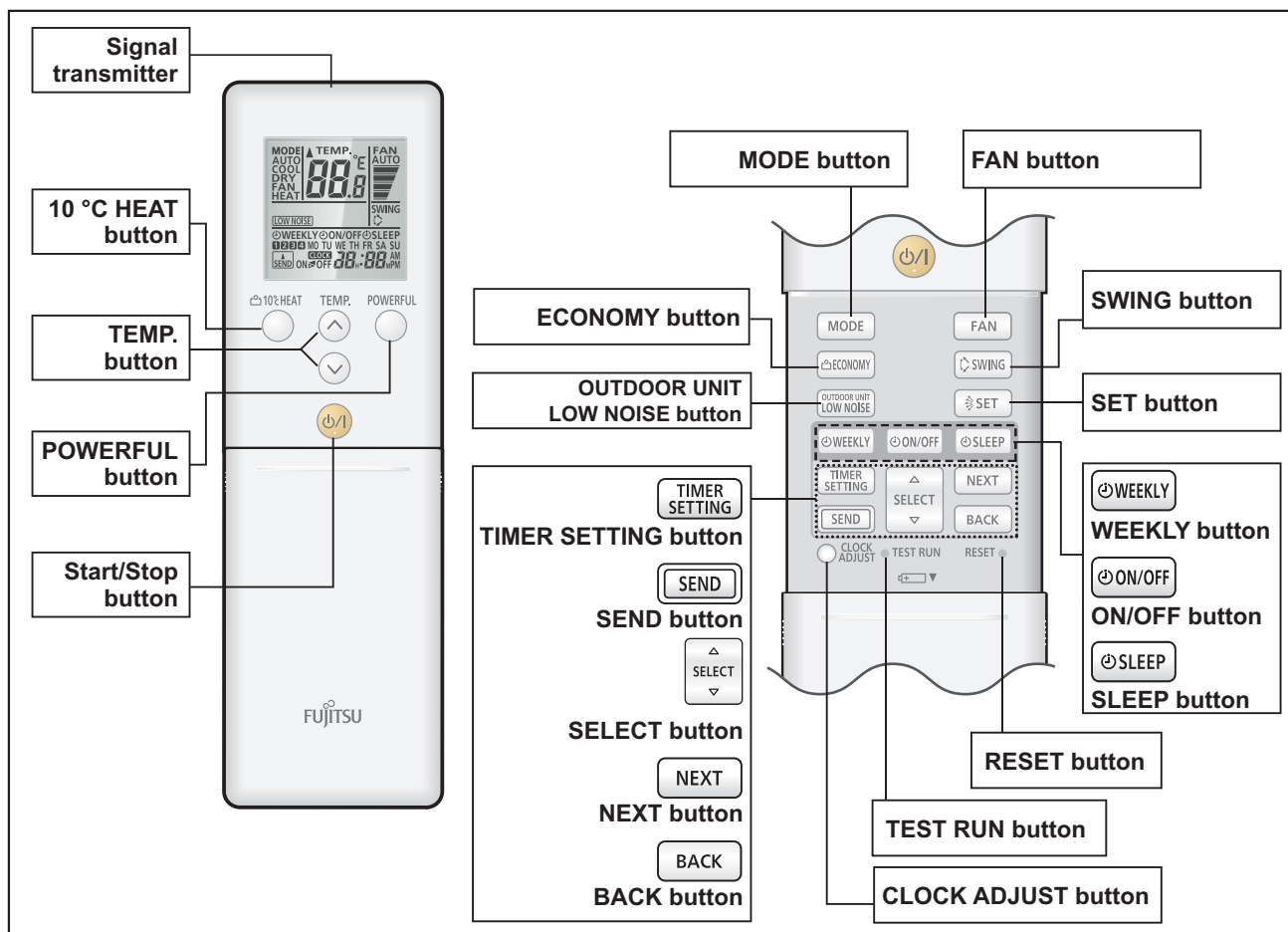

NOTE: Functions may differ by type of the indoor unit. For details, refer to the operation manual.
Display panel

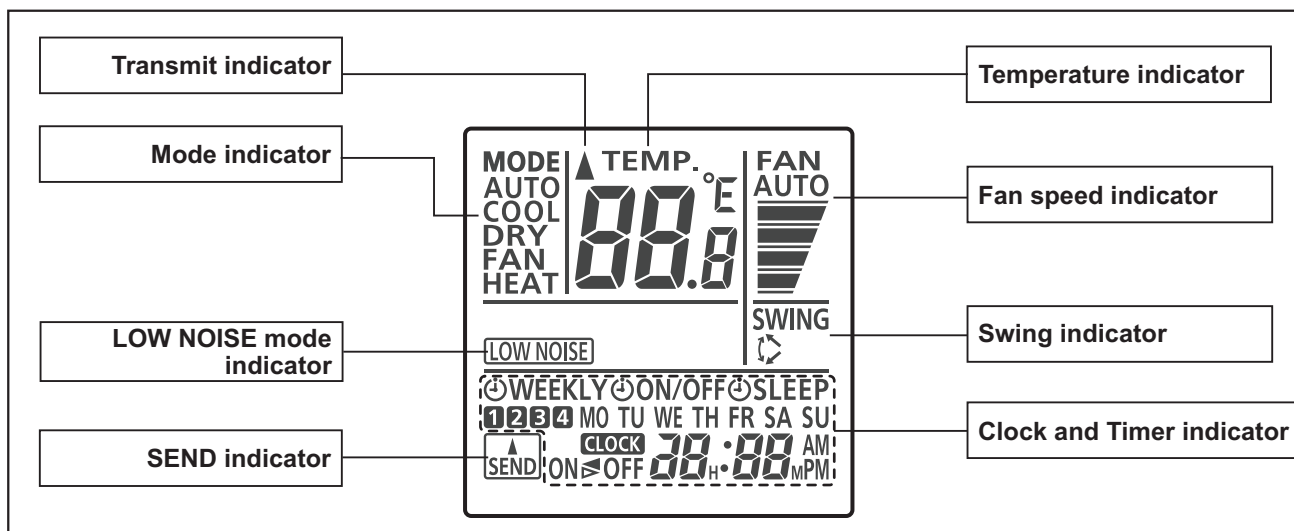

To facilitate explanation, the accompanying illustration has been drawn to show all possible indicators; in actual operation, however, the display will only show those indicators appropriate to the current operation.

■ Specifications

● Controller

Unit: mm

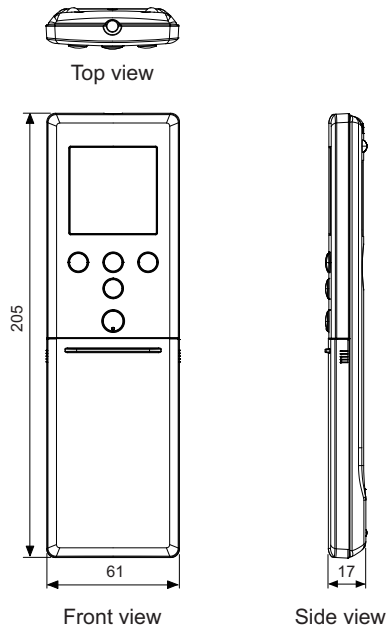

Size (H × W × D)	mm	205 × 61 × 17
Weight	g	124 (without batteries)

● Holder

Unit: mm

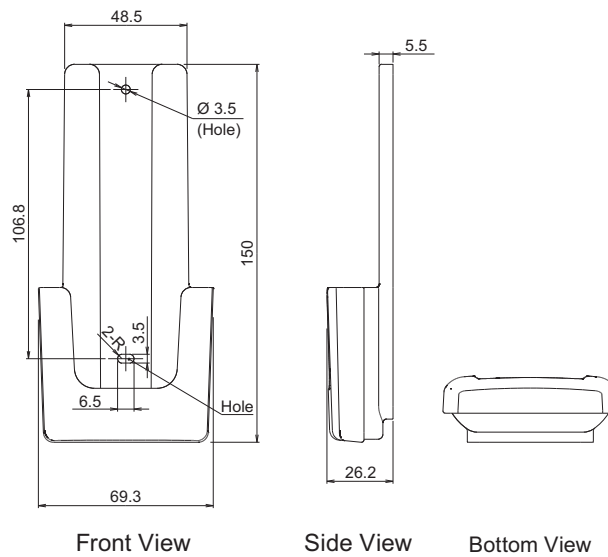

Size (H × W × D)	mm	150 × 69.3 × 26.2
Weight	g	27

13-4. Wireless remote controller (UTY-LNTY: Optional part)

Overview

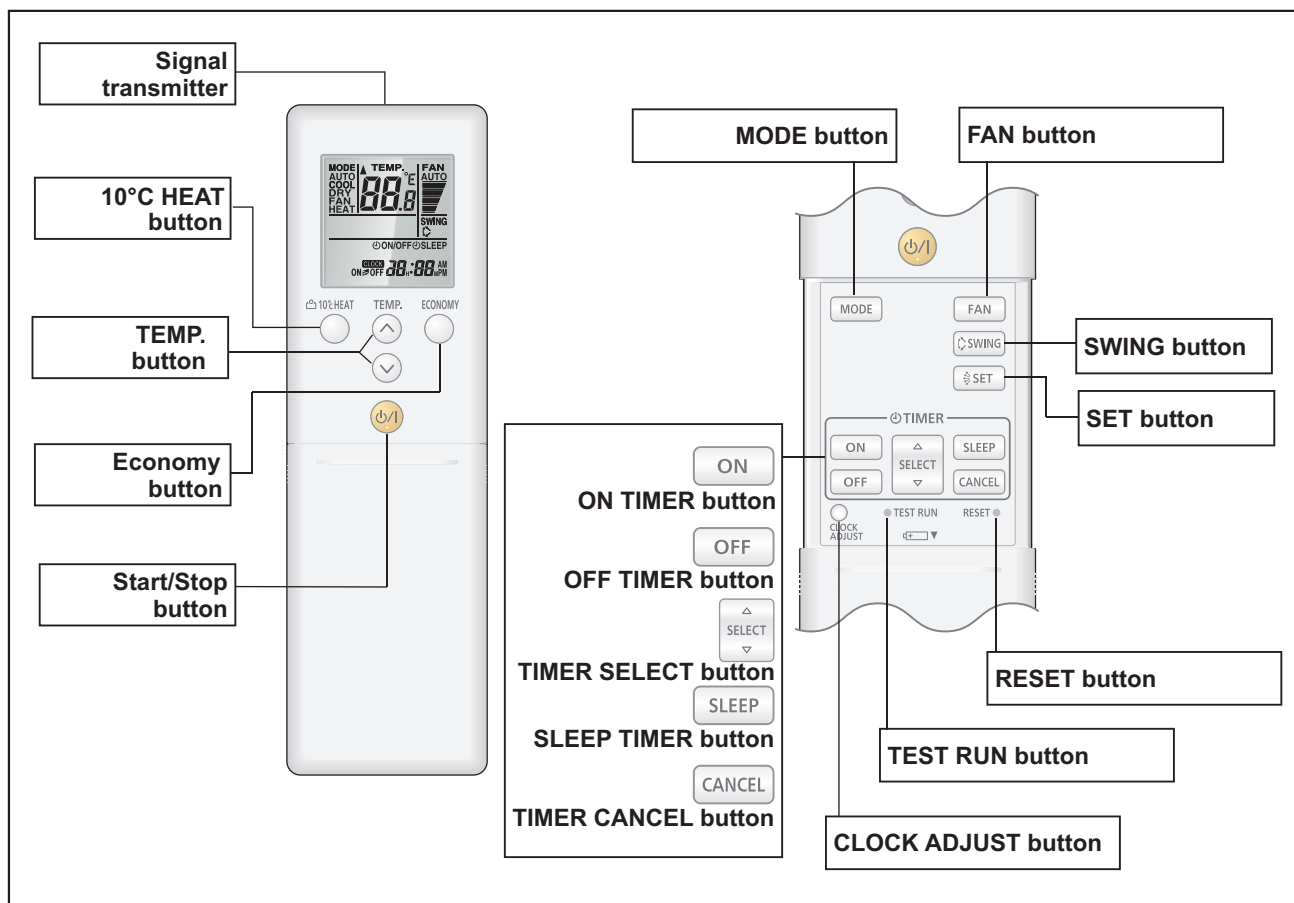

NOTE: Functions may differ by type of the indoor unit. For details, refer to the operation manual.

Display panel

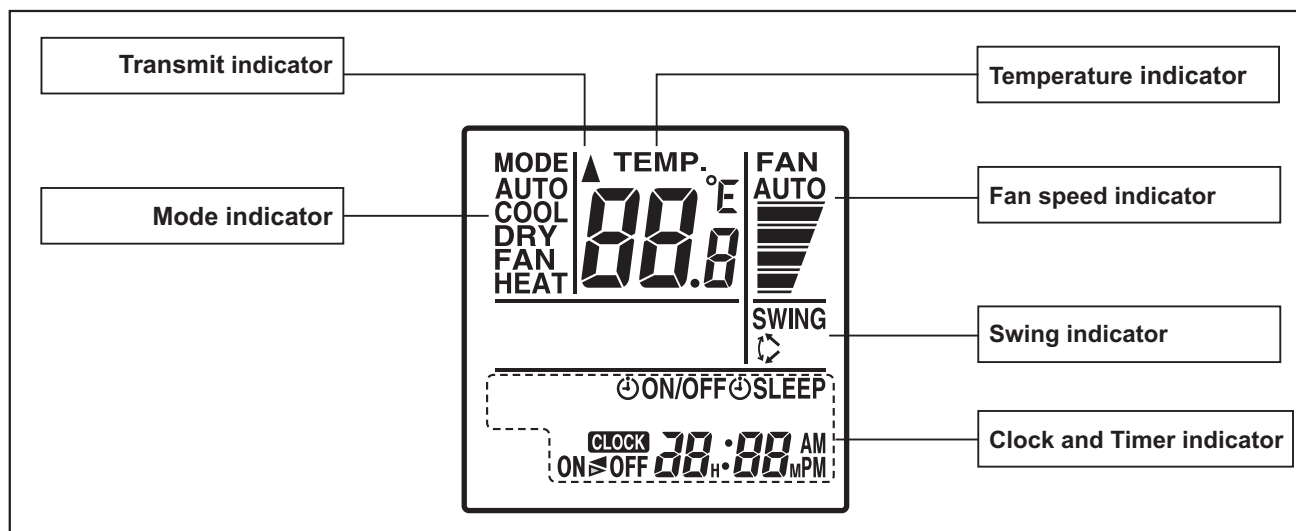

To facilitate explanation, the accompanying illustration has been drawn to show all possible indicators; in actual operation, however, the display will only show those indicators appropriate to the current operation.

Specifications

● Controller

Unit: mm

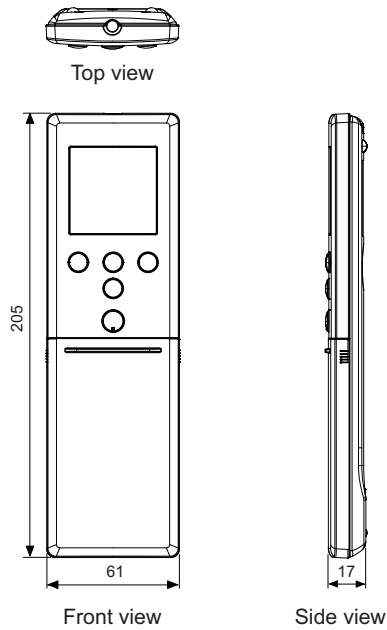

Size (H × W × D)	mm	205 × 61 × 17
Weight	g	124 (without batteries)

● Holder

Unit: mm

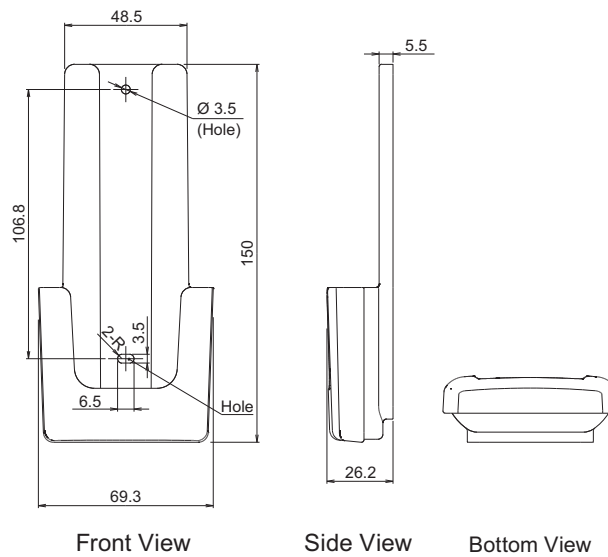

Size (H × W × D)	mm	150 × 69.3 × 26.2
Weight	g	27

13-5. IR receiver kit with Wireless remote controller (UTY-LBTYM: Optional part)

Overview

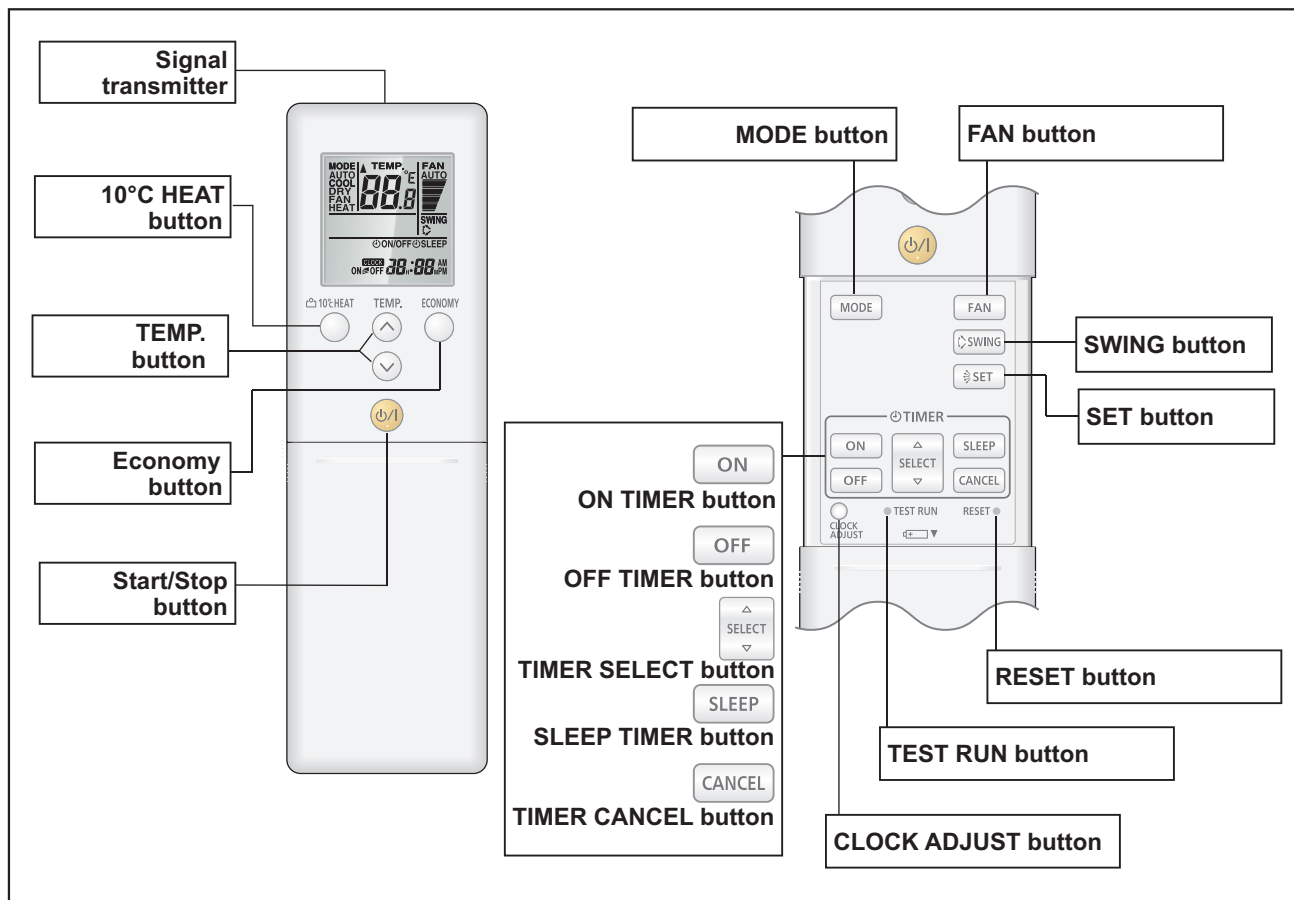

NOTE: Functions may differ by type of the indoor unit. For details, refer to the operation manual.

Display panel

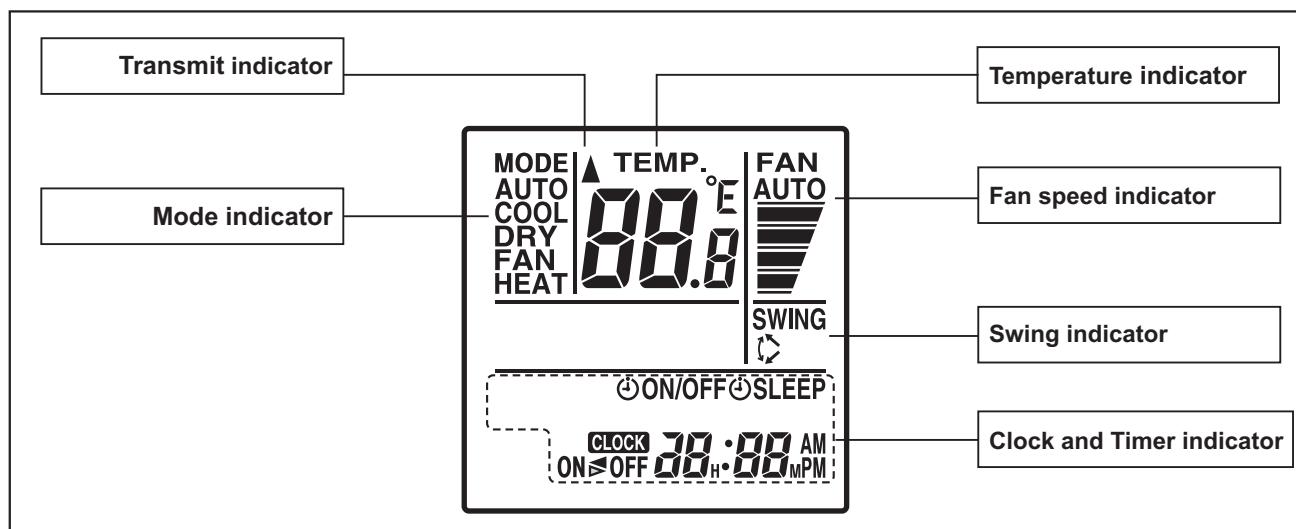

To facilitate explanation, the accompanying illustration has been drawn to show all possible indicators; in actual operation, however, the display will only show those indicators appropriate to the current operation.

■ Specifications

● Controller

Unit: mm

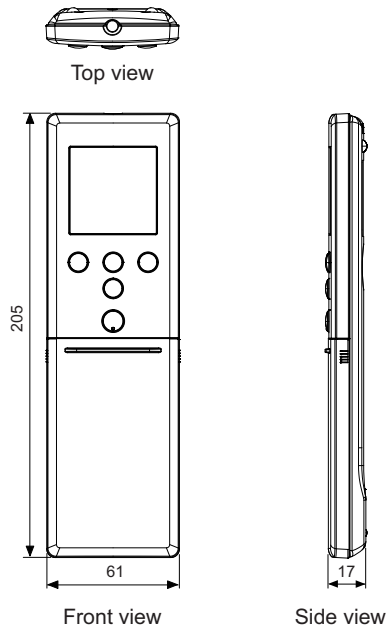

Size (H × W × D)	mm	205 × 61 × 17
Weight	g	124 (without batteries)

● Holder

Unit: mm

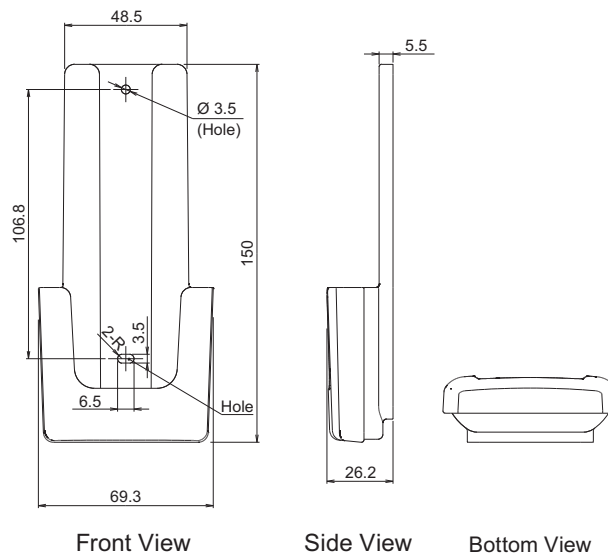

Size (H × W × D)	mm	150 × 69.3 × 26.2
Weight	g	27

● IR receiver

Unit: mm

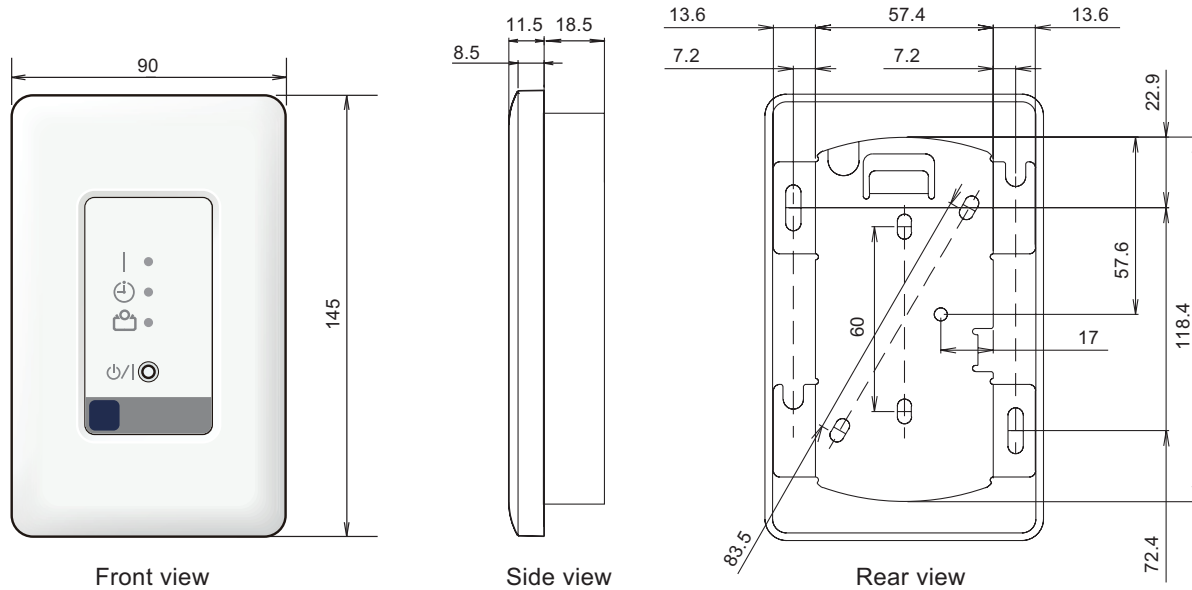

Size (H × W × D)	mm	145 × 90 × 30
Weight	g	150

13-6. Wired remote controller (UTY-RNNYM: Optional part)



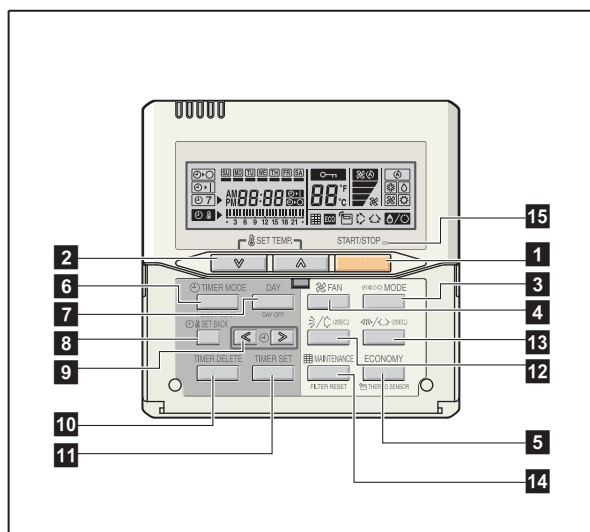



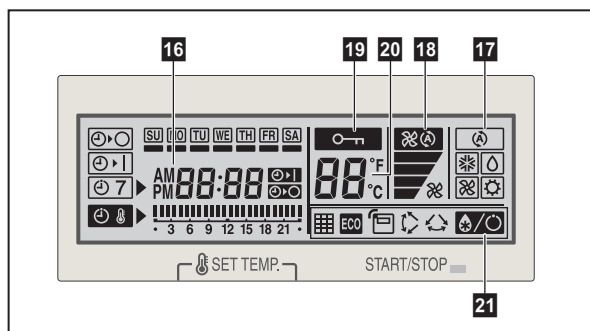









Overview



Display panel



NOTE: Functions may differ by type of the indoor unit. For details, refer to the operation manual.

- 1 START/STOP button**
Starts and stops operation.
- 2 SET TEMP. button**
Selects the setting temperature.
- 3 MODE button**
Selects the operating mode (AUTO , HEAT , FAN , COOL , and DRY ).
- 4 FAN button**
Selects the fan speed AUTO , QUIET , LOW , MED , and HIGH .
- 5 ECONOMY (THERMO SENSOR) button**
Turns the economy-efficient mode on and off.
- 6 TIMER MODE (CLOCK ADJUST) button**
Selects the timer mode (off timer, on timer, and weekly timer). Sets the current time.
- 7 DAY (DAY OFF) button**
Temporarily cancels one day timer.
- 8 SET BACK button**
Selects the set back timer.
- 9 Set time button**
Pressed to set time.
- 10 TIMER DELETE button**
Deletes the weekly timer schedule.
- 11 TIMER SET button**
Sets the date, hour, minute, and on-off time.
- 12 Vertical airflow direction and swing button**
Push for 2 seconds to change the swing mode.
- 13 Horizontal airflow direction and swing button**
Push for 2 seconds to change the swing mode.
- 14 FILTER RESET button**
- 15 Operation lamp**
Lights during operation and when the timer is on.
- 16 Timer and clock indicator**
- 17 Operation mode indicator**
- 18 Fan speed indicator**
- 19 Operation lock indicator**
- 20 Temperature indicator**
- 21 Function indicators**
 -  Defrost indicator
 -  Thermo sensor indicator
 -  Economy indicator
 -  Vertical swing indicator
 -  Horizontal swing indicator
 -  Filter indicator

System diagram

1 remote controller:

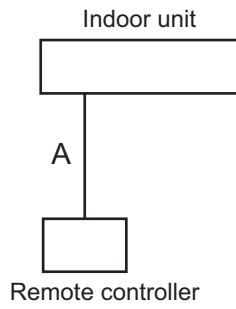

2 remote controllers:

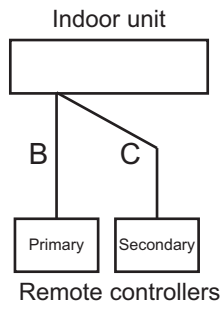

A, B, C: Remote controller cable
 $A \leq 500 \text{ m}; B + C \leq 500 \text{ m}$

Electrical wiring

1 remote controller:

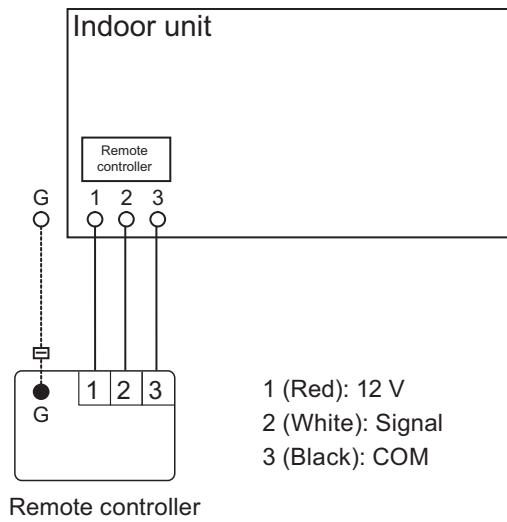

2 remote controllers:

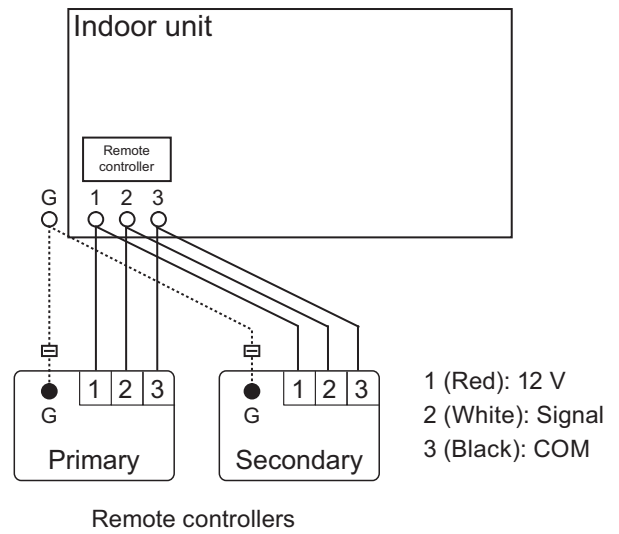

■ Specifications

Dimensions and other specifications on the wired remote controller are as follows.

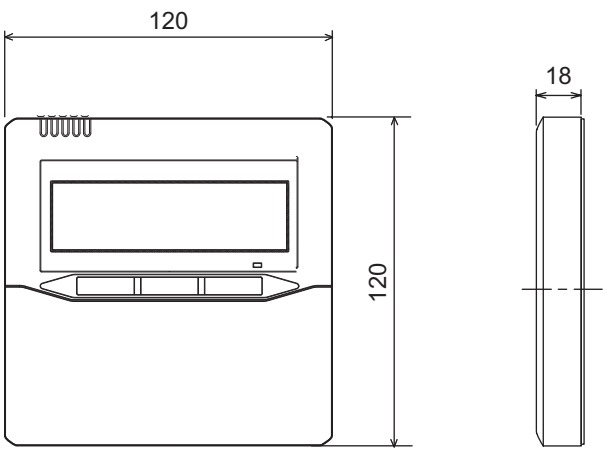
		Unit: mm
		
Front view		Side view
Size (H × W × D)	mm	120 × 120 × 18
Weight	g	160
Cable length (accessory)	m	10
Power	V	12

● Wiring specifications

Use	Cable size	Wire type	Remarks
Remote controller cable	0.33 mm ² (22 AWG)	Polar 3-core	Use sheathed PVC cable.

■ Installation

Connection pattern of wired remote controller varies by the type of the connected indoor unit.

● When connecting to terminal block (for Compact cassette, Slim duct, and Mini duct types)

Connect the end of remote controller cable directly to the exclusive terminal block.

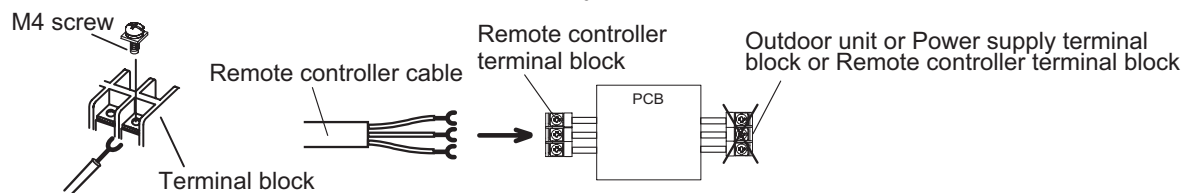

NOTE: It may be failed if it is connected to the outdoor unit or the terminal block for power supply.

● When connecting to Communication kit (for KM models in Wall mounted type)

When connecting the remote controller to optional Communication kit, follow the procedures mentioned below.

1. Modify the remote controller cable as follows:
 - Use a tool to cut off the terminal on the end of the remote controller cable and then remove the insulation from the cut end of the cable as shown in following figure.
 - Connect the remote controller cable and connecting cable as shown in following figure.
 - Be sure to insulate the connection between the cables.

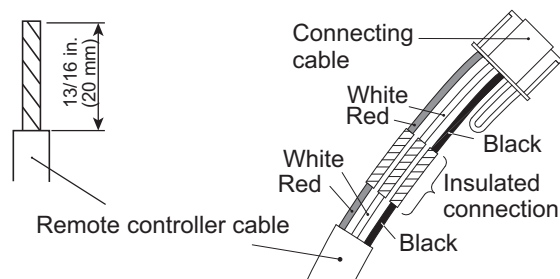

2. Connect the remote controller cable.
 - Connect the cable made in step 1. to the terminal*1 of optional Communication kit.
 - Connect the cable from the terminal*2 of Communication kit to the indoor unit PCB.

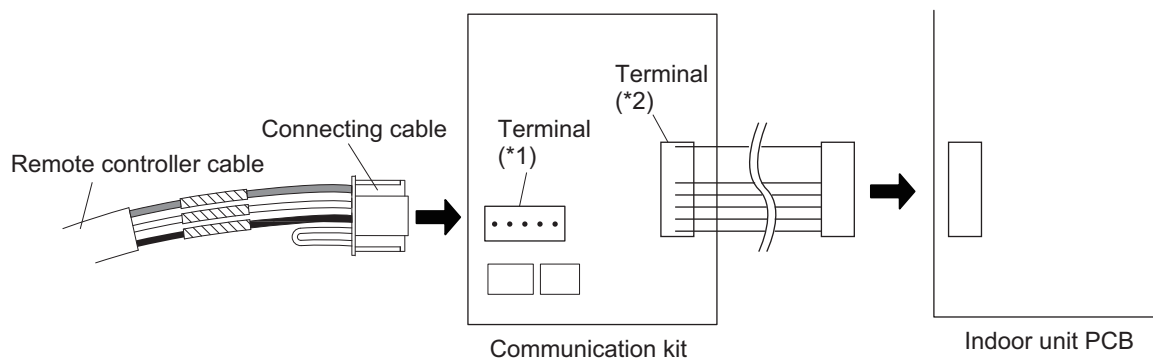

■ Required optional parts

Required optional parts for connecting the wired remote controller to the wall mounted type are as follows.

Part name	Model name
External connect kit	UTY-TWBXF2
Communication kit	UTY-XWZXZ5

13-7. Wired remote controller (UTY-RLRY: Optional part)

Overview

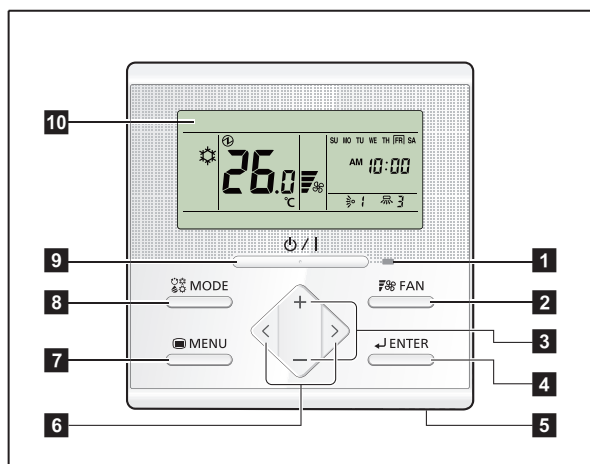

Display panel

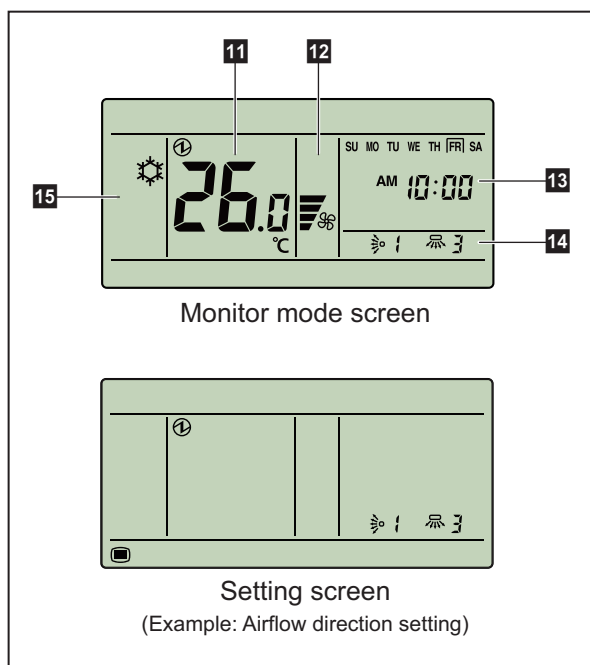

NOTE: For individual icons in Setting screen and related functions, refer to the operation manual.

1 LED lamp (Operation indicator)

Lights while the indoor unit is operating. Blinks when an error occurred.

2 FAN button

Each time the button is pressed, fan speed switches as follows:

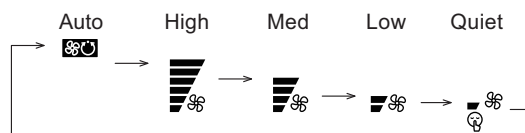

3 +, - buttons (Set temperature buttons)

Used to adjust temperature in Monitor mode screen.

+ button: Raise

- button: Lower

In Setting screen, used to select the setting items.

NOTE: When the operation mode is set to FAN, the temperature cannot be adjusted.

4 ENTER button

Used to enter setting items and settings.

5 Room temperature sensor (inside)

Senses ambient temperature of unit.

6 <, > buttons

Used to select setting items during the setting item selection screen is displayed.

7 MENU button

Used to display the setting item selection screen.

8 MODE button

Each time the button is pressed, operation mode switches as follows:



9 On/Off button

Starts or stops the operation.

NOTE: On/Off button cannot be operated at screens other than the Monitor mode screen.

10 Display panel

Displays Monitor mode screen or Setting screen. Monitor mode screen is home screen of this controller, and the basic operation is performed in this screen. In Setting screen, several settings are adjustable.

11 Temperature indicator

12 Fan speed indicator

13 Clock indicator

14 Airflow direction indicator

15 Operation mode indicator

System diagram

1 remote controller:

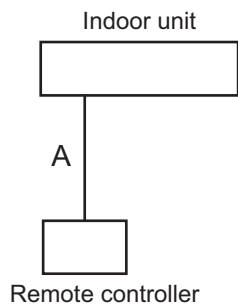

2 remote controllers:

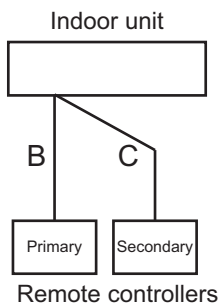

A, B, C: Remote controller cable
 $A \leq 500 \text{ m}; B + C \leq 500 \text{ m}$

Electrical wiring

1 remote controller:

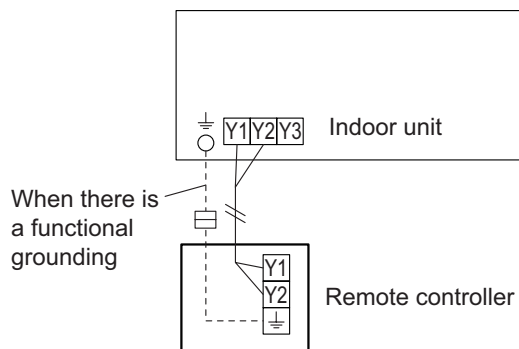

2 remote controllers:

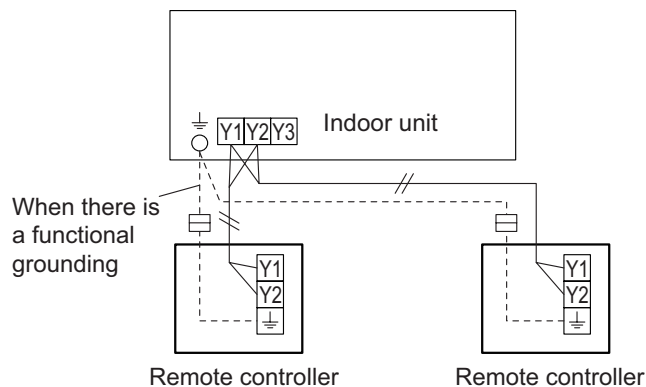

Group control:

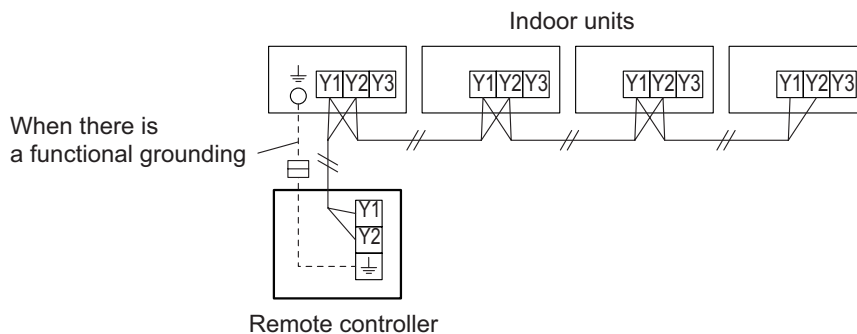

NOTE: Group connection with Polar 3-wired remote controller is not allowed.

■ Specifications

Dimensions and other specifications on the wired remote controller are as follows.

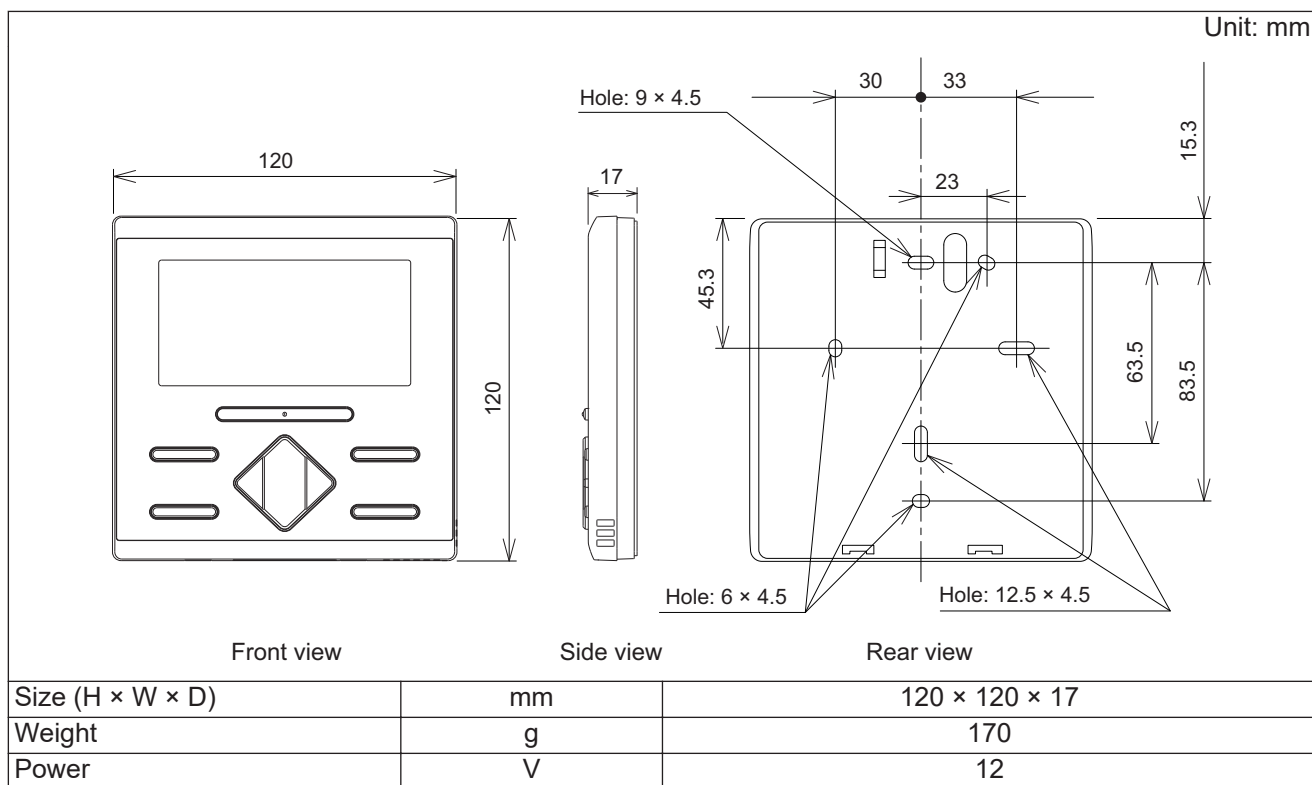

● Wiring specifications

Use	Cable size	Wire type	Remarks
Remote controller cable	0.33 to 1.25 mm ²	Non-polar 2-core, Twisted pair	Use sheathed PVC cable.

■ Installation

Connect the end of remote controller cable directly to the exclusive terminal block.

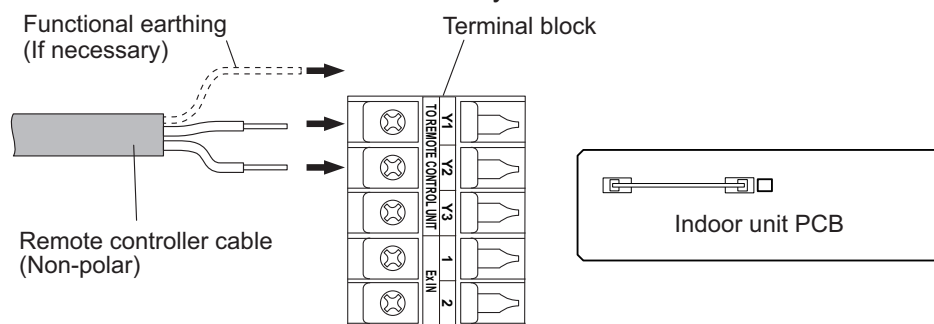

NOTES:

- Layout of terminal block and PCB is varies depending on the type of indoor unit.
- Operation may fail if it is connected to the outdoor unit or the terminal block for power supply.

13-8. Wired remote controller (UTY-RVNYM: Optional part)

■ Overview

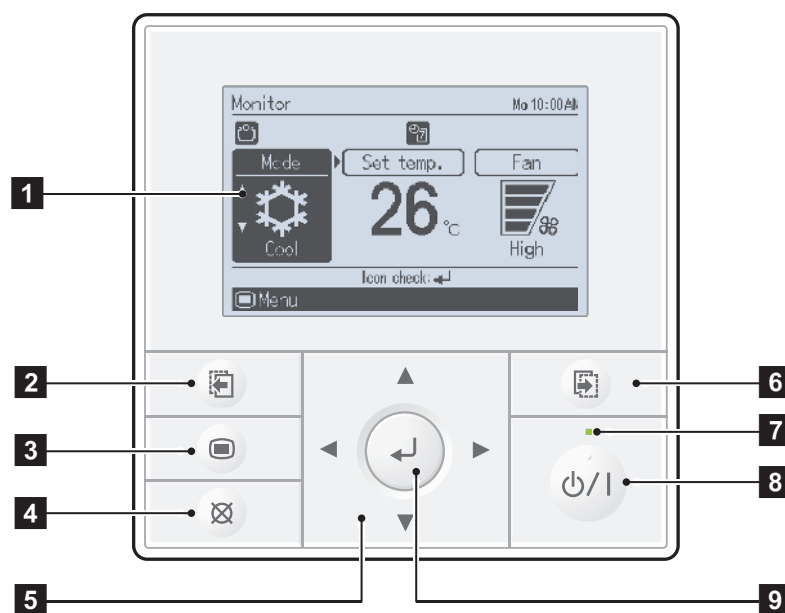

- 1** Display panel (with backlight)
- 2** Screen switch button (Left)
- 3** Menu button
- 4** Cancel button
- 5** Cursor button
- 6** Screen switch button (Right)
- 7** Power indicator
- 8** On/off button
- 9** Enter button

System diagram

1 remote controller:

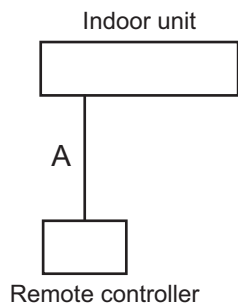

2 remote controllers:

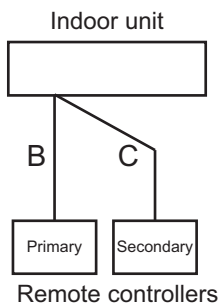

A, B, C: Remote controller cable
 $A \leq 500 \text{ m}$; $B + C \leq 500 \text{ m}$

Electrical wiring

1 remote controller:

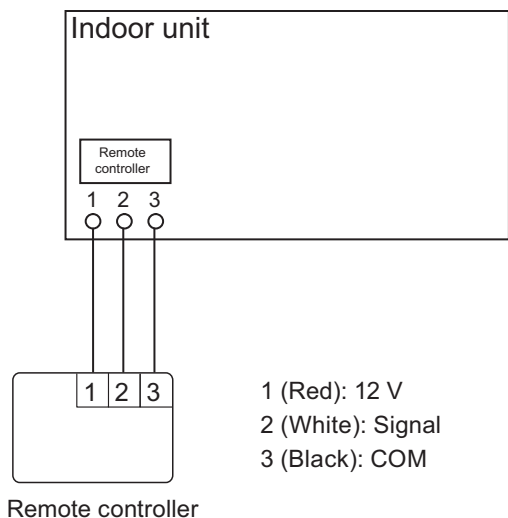

2 remote controllers:

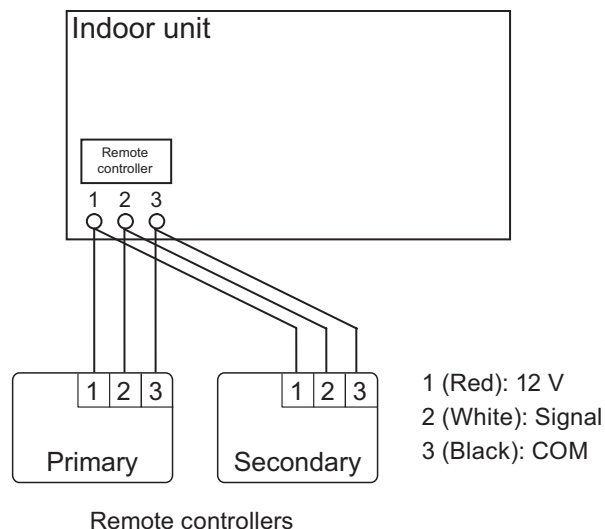

Controller combination

As for the combined usage of the controller, refer to following figures.

● Good

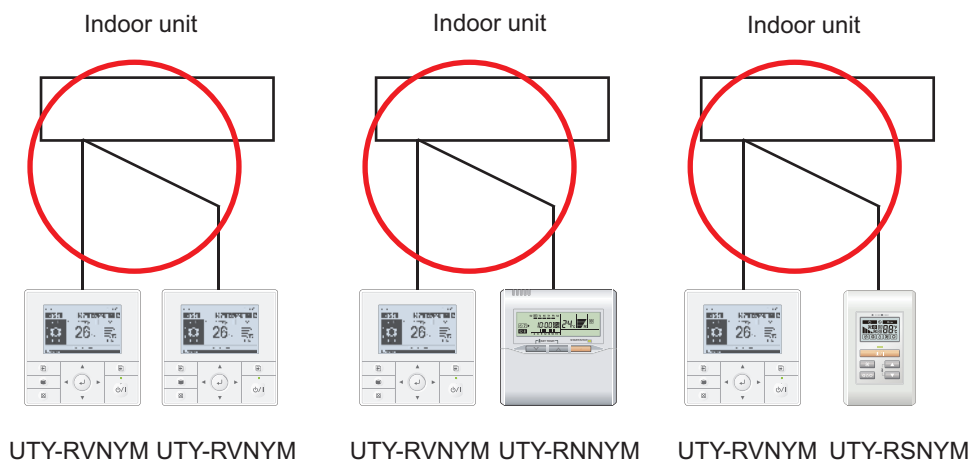

■ Specifications

Unit: mm

Size (H × W × D)	mm	120 × 120 × 21.3
Weight	g	220

● Wiring specifications

Use	Cable size	Wire type	Remarks
Remote controller cable	0.33 mm ²	Polar 3 core	Use sheathed PVC cable.

■ Installation (Remote control main unit)

Installation space:

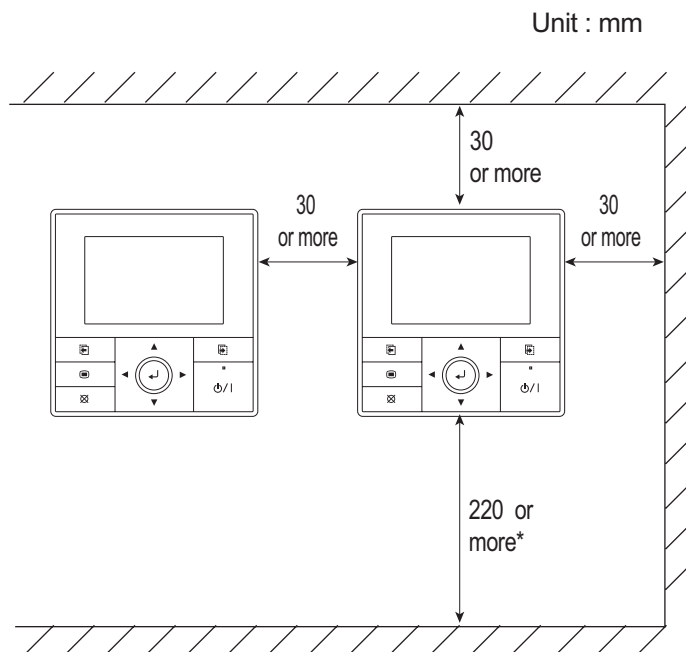

NOTE: Secure enough space where a flat-blade screwdriver to remove the case can be inserted.

Installation procedures:

1. Process the remote controller cable.

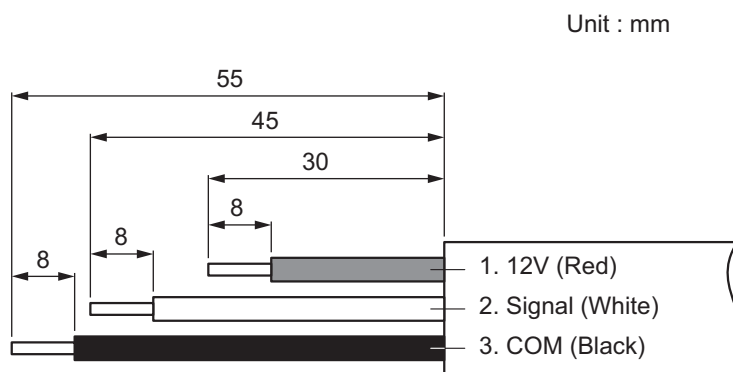

2. Insert the flat-blade screwdriver and twist it slightly to separate the front case and rear case.

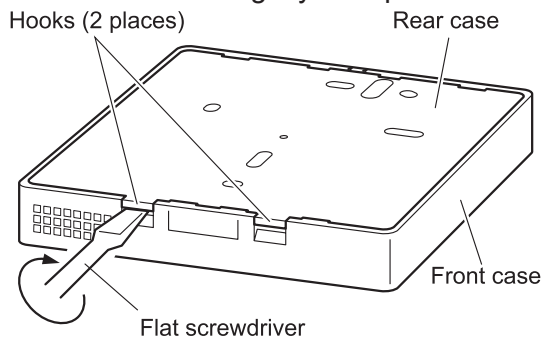

3. Attach the remote controller.

• **When attaching to switch box:**

- Seal the wiring hole of the remote controller cable.
- Put a remote controller cable through the hole of the rear case.
- Fix the rear case by securing it with attached screws (2 places).

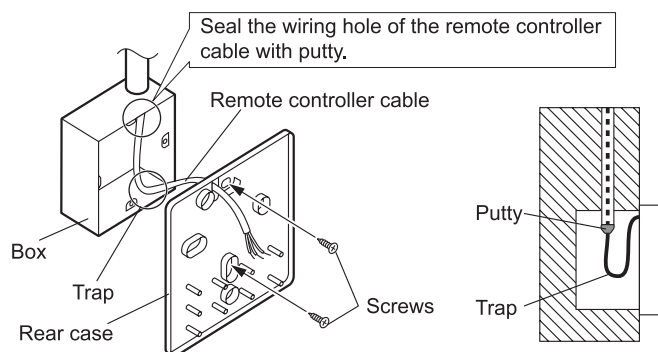
• **When attaching to the wall directly:**

- Seal the wiring hole of the remote controller cable.
- Put a remote controller cable through the back hole of the rear case of the main body.
- Fix the rear case by securing it with attached screws (2 places).

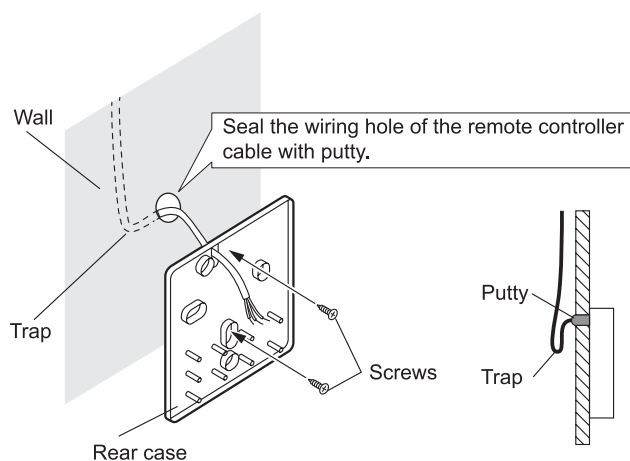
• **When routing the cable on-wall:**

- Cut off the cable guide of the front case with using a knife or a nipper.
- Deburr the edge of the cable guide.

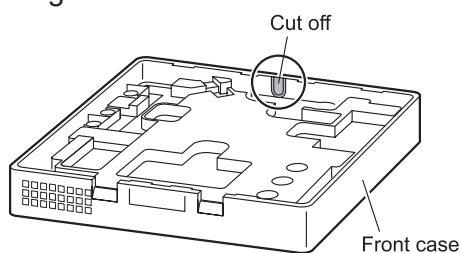

- Fix the rear case by securing it with attached screws (2 places).

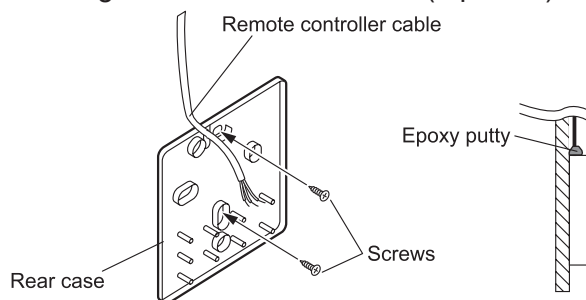

4. Connect the cable to the terminals on the front case.
Fix the cable together with the sheath with the cable tie. Cut off the excess cable tie.

Tightening torque	
Terminal screw	0.8 to 1.2 N•m

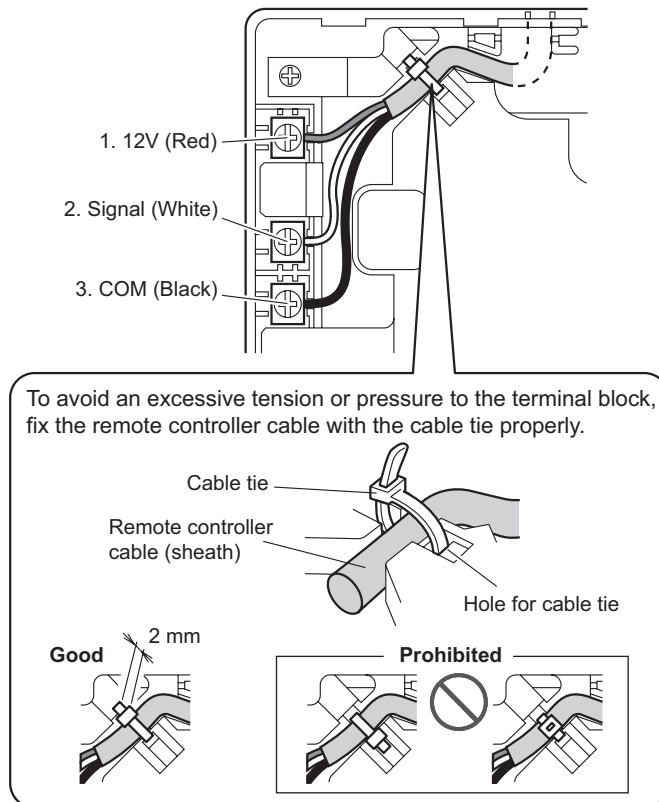

⚠ CAUTION

- Be careful to avoid breaking the cable by over-tightening the cable tie.
- When connecting the remote controller cables, do not over-tighten the screws.

5. Attach the front case.
 - Insert after adjusting upper part of front case.
 - When insert the front case, do not pinch the cable.

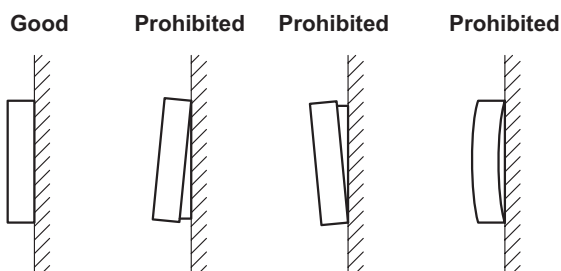
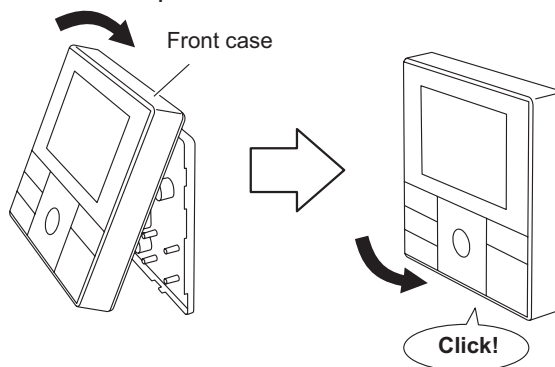

⚠ CAUTION

Insert the upper case firmly. If improperly attached, it will cause the upper case to fall off.

■ Installation

Connection pattern of wired remote controller varies by the type of the connected indoor unit.

● When connecting to terminal block (for Compact cassette, Slim duct, and Mini duct types)

Connect the end of remote controller cable directly to the exclusive terminal block.

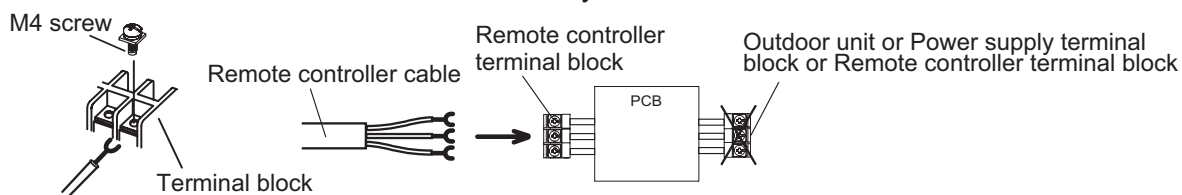

NOTE: It may be failed if it is connected to the outdoor unit or the terminal block for power supply.

● When connecting to Communication kit (for KM models in Wall mounted type)

When connecting the remote controller to optional Communication kit, follow the procedures mentioned below.

1. Modify the remote controller cable as follows:
 - Use a tool to cut off the terminal on the end of the remote controller cable and then remove the insulation from the cut end of the cable as shown in following figure.
 - Connect the remote controller cable and connecting cable as shown in following figure.
 - Be sure to insulate the connection between the cables.

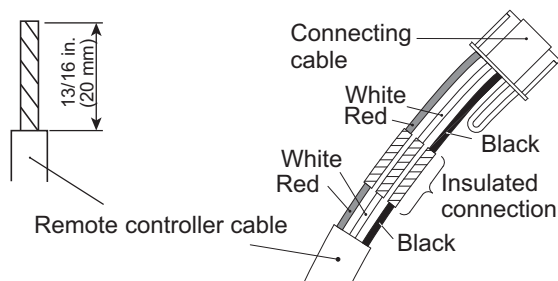

2. Connect the remote controller cable.
 - Connect the cable made in step 1. to the terminal*¹ of optional Communication kit.
 - Connect the cable from the terminal*² of Communication kit to the indoor unit PCB.

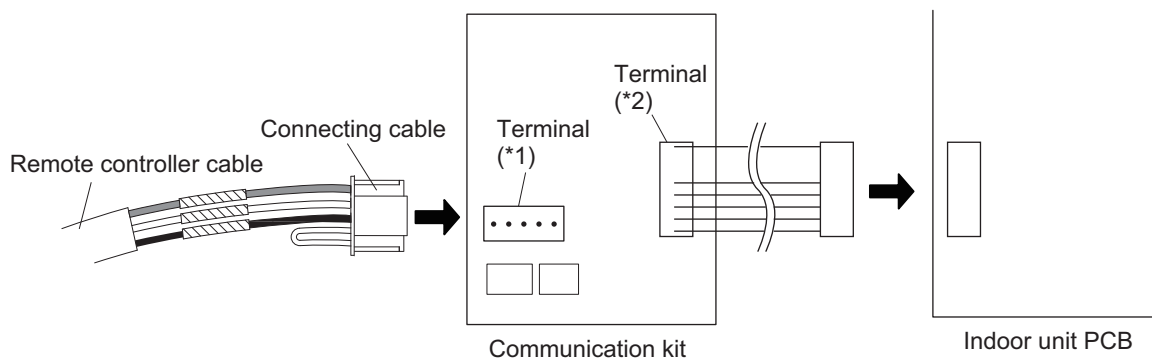

■ Required optional parts

Required optional parts for connecting the wired remote controller to the wall mounted type are as follows.

Part name	Model name
External connect kit	UTY-TWBXF2
Communication kit	UTY-XWZXZ5

13-9. Wired remote controller (UTY-RNRYZ*: Optional part)

Overview

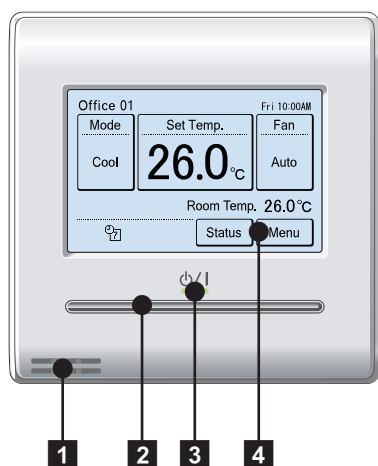

Display panel

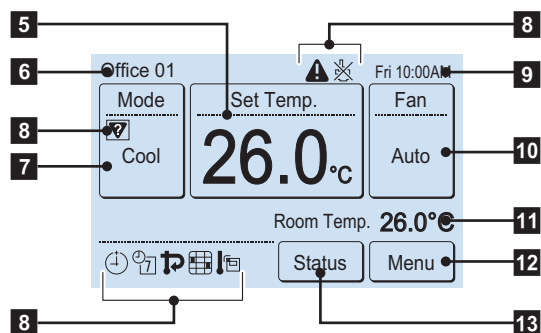

- 1 Remote temperature sensor (inside)**
- 2 On/off button**
Operable only while displaying the "Monitor mode" screen.
- 3 LED lamp (operation indicator)**
- 4 Touch panel display**
- 5 Set temperature**
Operating temperature can be set.
- 6 Remote controller group name**
- 7 Mode**
Operation mode can be set.
- 8 Status icons**
- 9 Clock**
- 10 Fan**
Fan speed can be set.
- 11 Room temperature**
- 12 Menu**
Various settings can be set.
- 13 Status**
Status of the indoor unit and error can be checked.

NOTE: Functions may differ by type of the indoor unit. For details, refer to the operation manual.

System diagram

1 remote controller:

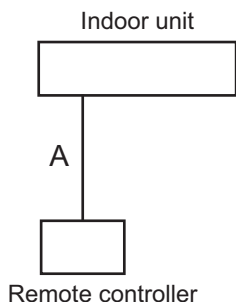

2 remote controllers:

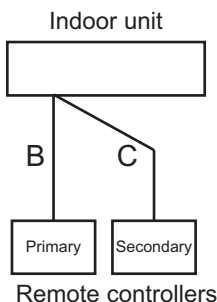

A, B, C: Remote controller cable
 $A \leq 500 \text{ m}; B + C \leq 500 \text{ m}$

Electrical wiring

1 remote controller:

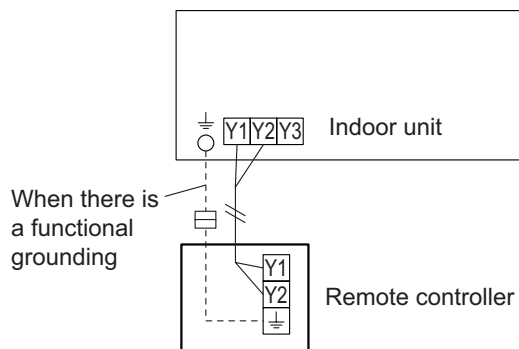

2 remote controllers:

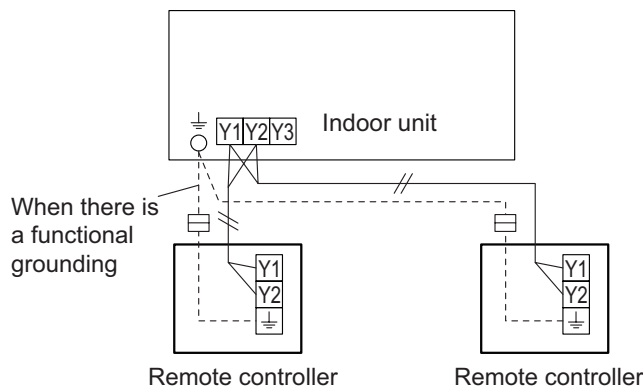

Group control:

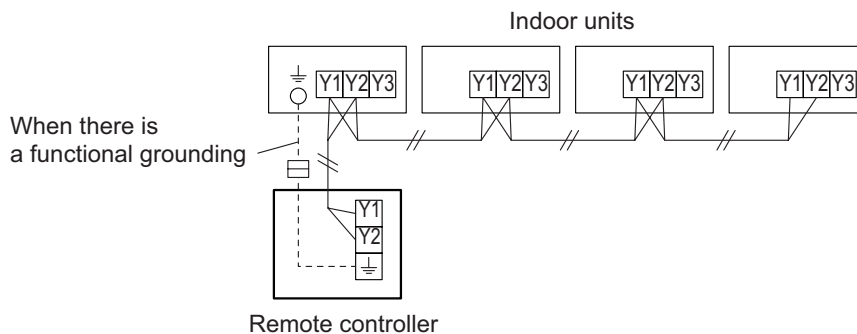

NOTE: Group connection with Polar 3-wired remote controller is not allowed.

■ Specifications

Dimensions and other specifications on the wired remote controller are as follows.

[Unit : mm]

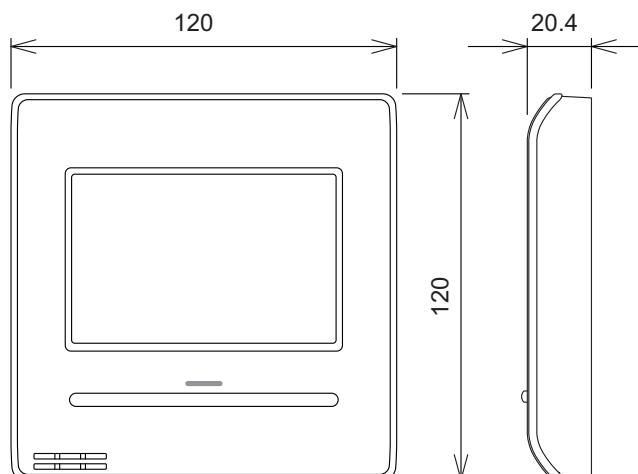

Model name	UTY-RNRYZ*	
Display	3.8-inch FSTN LCD (255 × 160 dots) with touch panel	
Dimensions (H × W × D)	mm	120 × 120 × 20.4
Weight	g	220
Input voltage	V	DC 12
Power consumption	W	Max. 0.3
Usage temperature range	°C	0 to 40
Usage humidity range	%	20 to 90 (no condensation)
Storage temperature range	°C	-10 to 60
Storage humidity range	%	20 to 90 (no condensation)

● Wiring specifications

Use	Cable size	Wire type	Remarks
Remote controller cable	0.33 to 1.25 mm ²	Non-polar 2-core, Twisted pair	Use sheathed PVC cable.

■ Installation

Connect the end of remote controller cable directly to the exclusive terminal block.

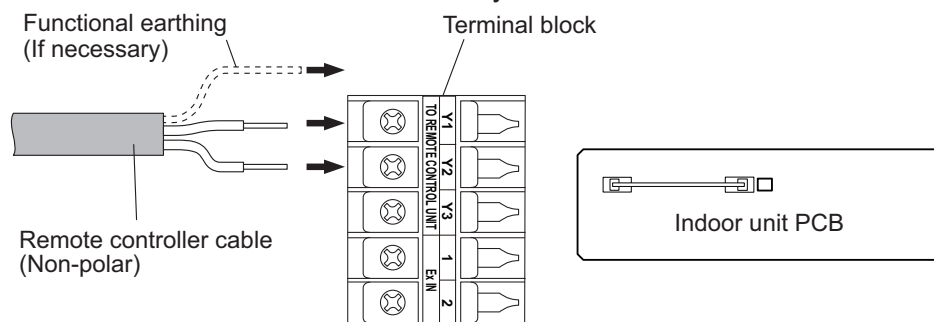

NOTES:

- Layout of terminal block and PCB is varies depending on the type of indoor unit.
- Operation may fail if it is connected to the outdoor unit or the terminal block for power supply.

13-10. Simple remote controller (UTY-RSNYM: Optional part)

Overview

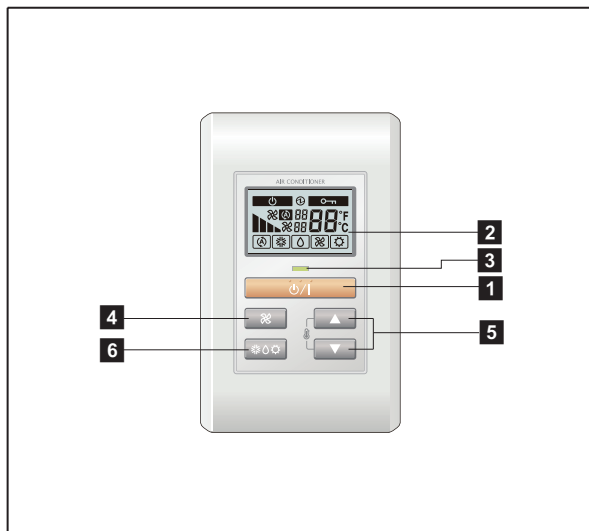

Display panel

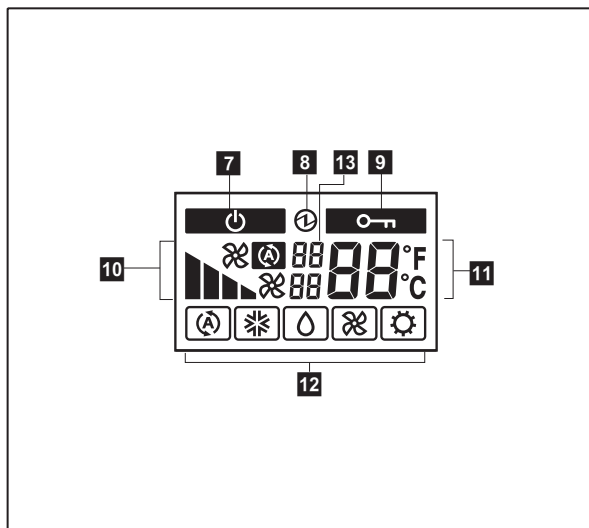

1 START/STOP button

Starts and stops operation.





2 Display backlight button

Lights during operation.

3 Operation lamp

Lights during operation.





4 FAN button

Selects the fan speed (AUTO , HIGH , MED , LOW , and QUIET ).

5 SET TEMP. button

Selects the setting temperature.

6 MODE button

Selects the operating mode (AUTO , COOL , DRY , FAN , HEAT ).

7 Standby indicator

Indicates during the oil recovery and defrosting operation.

8 Power source indicator

Indicates the main power is on.

9 Central control indicator

Indicates when function is locked.

10 Fan speed indicator

Deletes the weekly timer schedule.

11 Set temperature

- Indicates error history number in error code history display mode.
- Indicates indoor unit address in address display mode.

12 Operating mode indicator

13 Indicator

- Upper:
 - Indicates the error code in error code history display mode and in self diagnosis mode.
 - Indicates the refrigerant system address in address display mode.
- Lower: Indicates the remote controller address in error code history display mode, address display mode, and self diagnosis mode.

System diagram

1 remote controller:

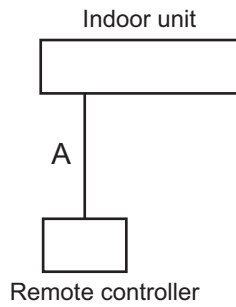

2 remote controllers:

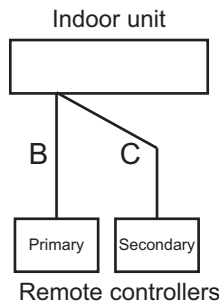

A, B, C: Remote controller cable
 $A \leq 500 \text{ m}; B + C \leq 500 \text{ m}$

Electrical wiring

1 remote controller:

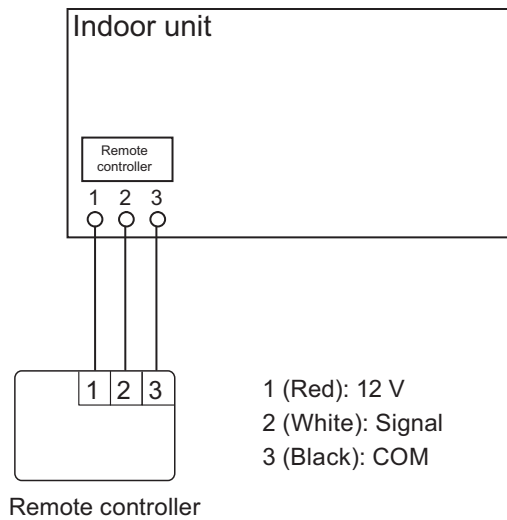

1 (Red): 12 V
 2 (White): Signal
 3 (Black): COM

2 remote controllers:

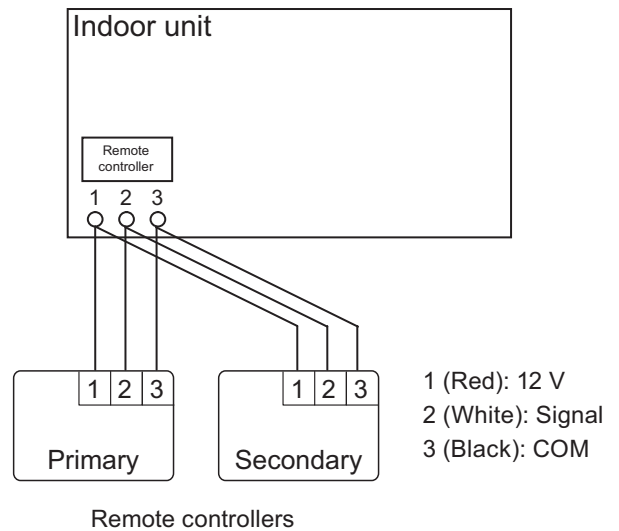

1 (Red): 12 V
 2 (White): Signal
 3 (Black): COM

■ Specifications

Dimensions and other specifications on the wired remote controller are as follows.

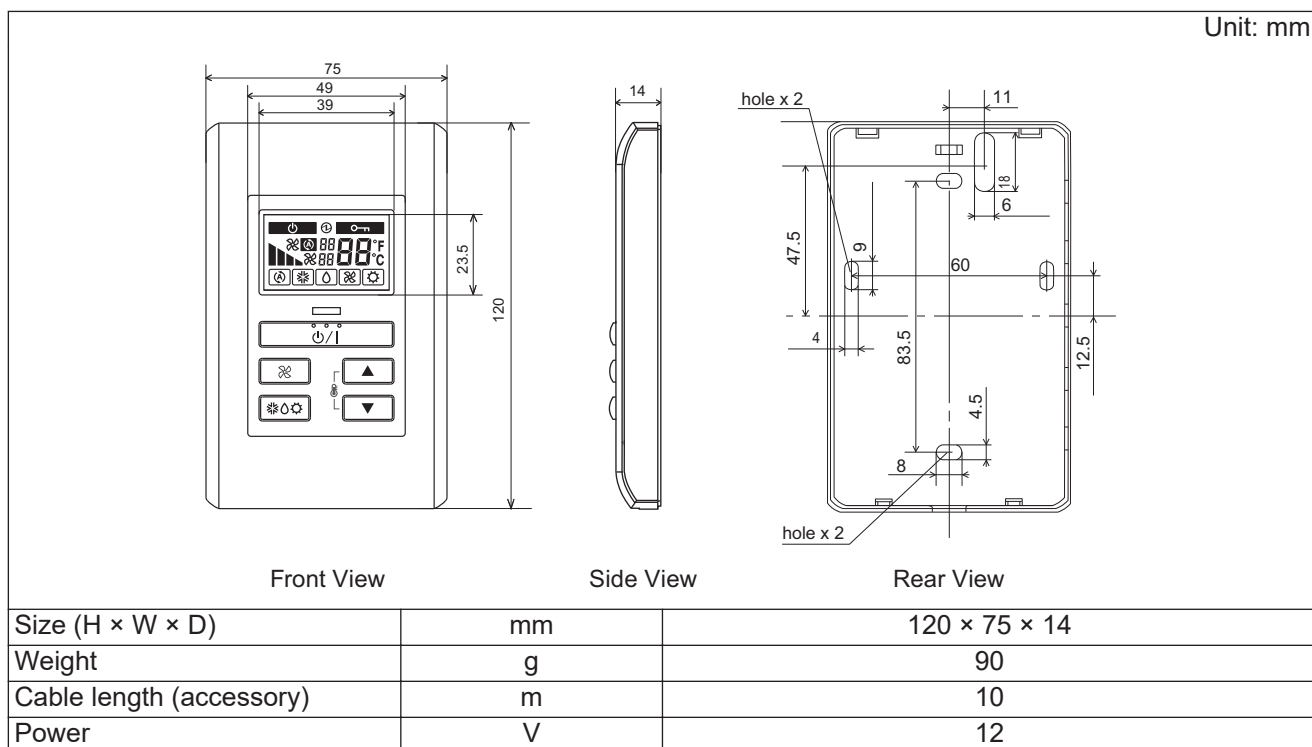

● Wiring specifications

Use	Size	Wire type	Remarks
Remote controller cable	0.33 mm ²	Polar 3 core	Use sheathed PVC cable.

■ Installation

Connection pattern of wired remote controller varies by the type of the connected indoor unit.

● When connecting to terminal block (for Compact cassette, Slim duct, and Mini duct types)

Connect the end of remote controller cable directly to the exclusive terminal block.

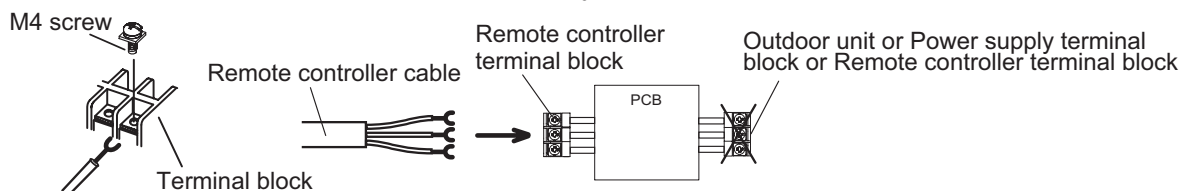

NOTE: It may be failed if it is connected to the outdoor unit or the terminal block for power supply.

● When connecting to Communication kit (for KM models in Wall mounted type)

When connecting the remote controller to optional Communication kit, follow the procedures mentioned below.

1. Modify the remote controller cable as follows:
 - Use a tool to cut off the terminal on the end of the remote controller cable and then remove the insulation from the cut end of the cable as shown in following figure.
 - Connect the remote controller cable and connecting cable as shown in following figure.
 - Be sure to insulate the connection between the cables.

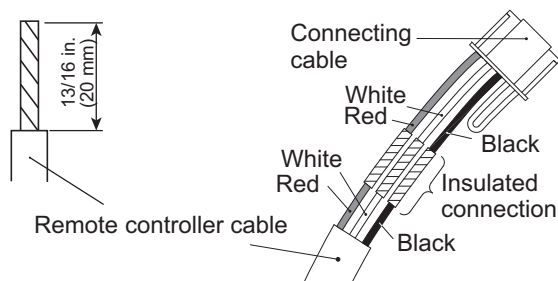

2. Connect the remote controller cable.
 - Connect the cable made in step 1. to the terminal*¹ of optional Communication kit.
 - Connect the cable from the terminal*² of Communication kit to the indoor unit PCB.

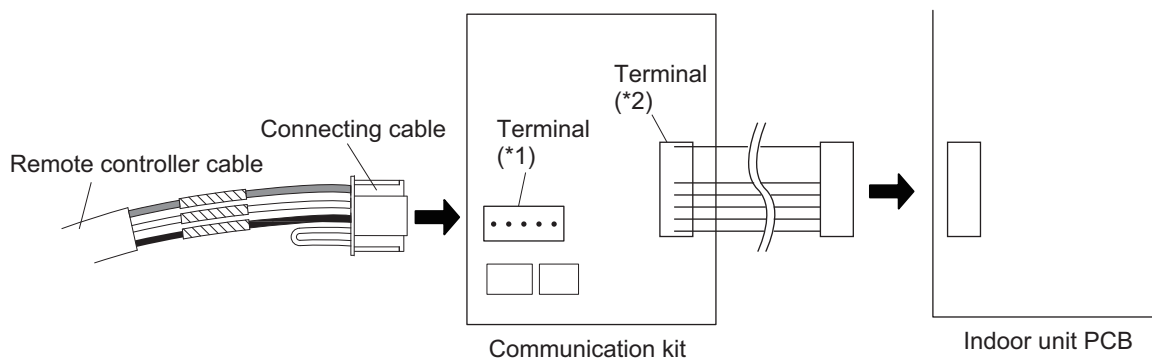

■ Required optional parts

Required optional parts for connecting the wired remote controller to the wall mounted type are as follows.

Part name	Model name
External connect kit	UTY-TWBXF2
Communication kit	UTY-XWZXZ5

13-11. Simple remote controller (UTY-RSRY and UTY-RHRY: Optional parts)

Overview

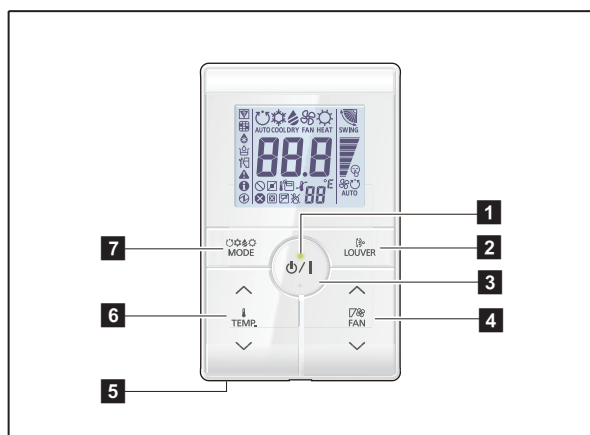

Display panel

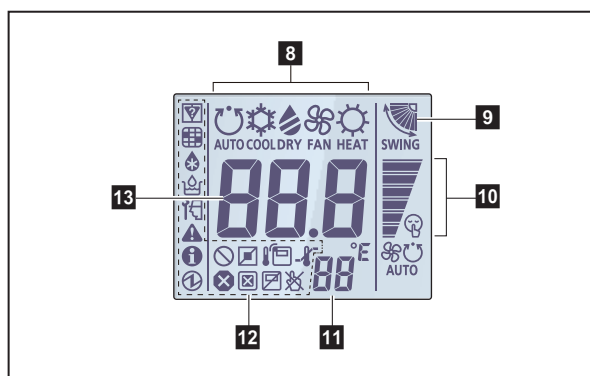

1: Available only for UTY-RSR.

*2: Not available for a heat pump model unless it is set up as an administrative indoor unit.

*3: Not available for a heat pump model.

*4: Not available for a cooling-only model.

*5: Set the function setting of the indoor unit accordingly.

*6: During address display mode.

1 LED lamp

Lights during operation.

2 Louver button

Adjusts the airflow direction.

3 START/STOP button

Starts and stops operation.

4 FAN control button

Switches the fan speed as follows:

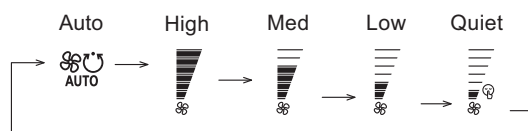

5 Room temperature sensor (inside)

Senses ambient temperature of unit.

6 Set temperature button

Selects the setting temperature. (18—30 °C [COOL], 10—30 °C [HEAT])

7 Operation mode button*1

Switches the operation mode as follows:



8 Operating mode indicator

9 Airflow direction indicator

10 FAN speed indicator

11 Remote controller address indicator

12 Status icons

- Mode mismatch
- Filter sign *5
- Defrost operation
- Oil recovery operation
- Under maintenance
- Error
- Special state
- Conducting electricity
- Emergency stop
- Operation controlled
- Forced stop
- Remote controller sensor is enabled *5
- Central controlled
- Setting temperature range is enabled
- Operation prohibited

13 Set temperature

Indicates indoor unit address. *6

System diagram

1 remote controller:

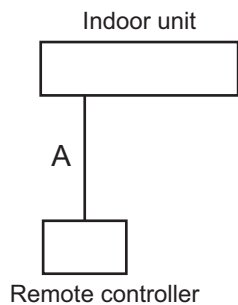

2 remote controllers:

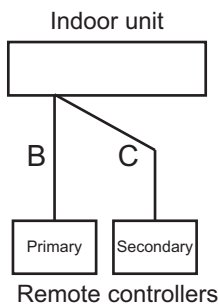

A, B, C: Remote controller cable
 $A \leq 500 \text{ m}; B + C \leq 500 \text{ m}$

Electrical wiring

1 remote controller:

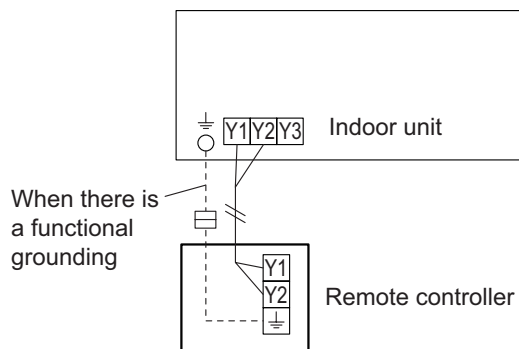

2 remote controllers:

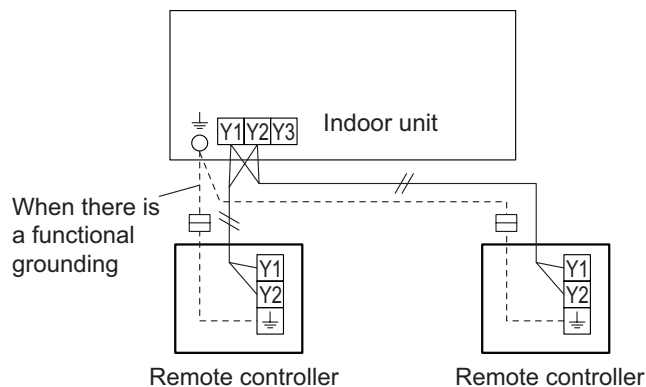

Group control:

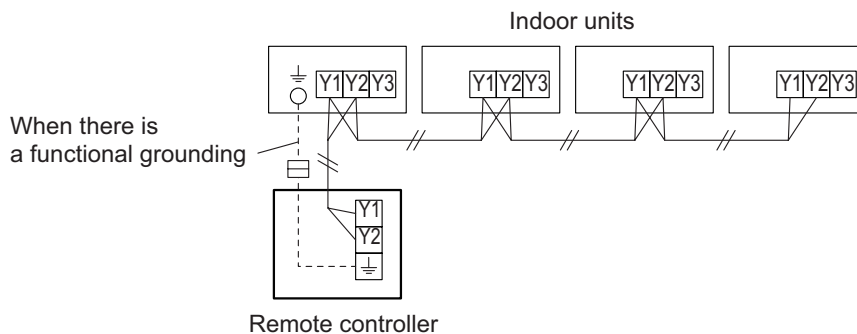

NOTE: Group connection with Polar 3-wired remote controller is not allowed.

Specifications

Dimensions and other specifications on the wired remote controller are as follows.

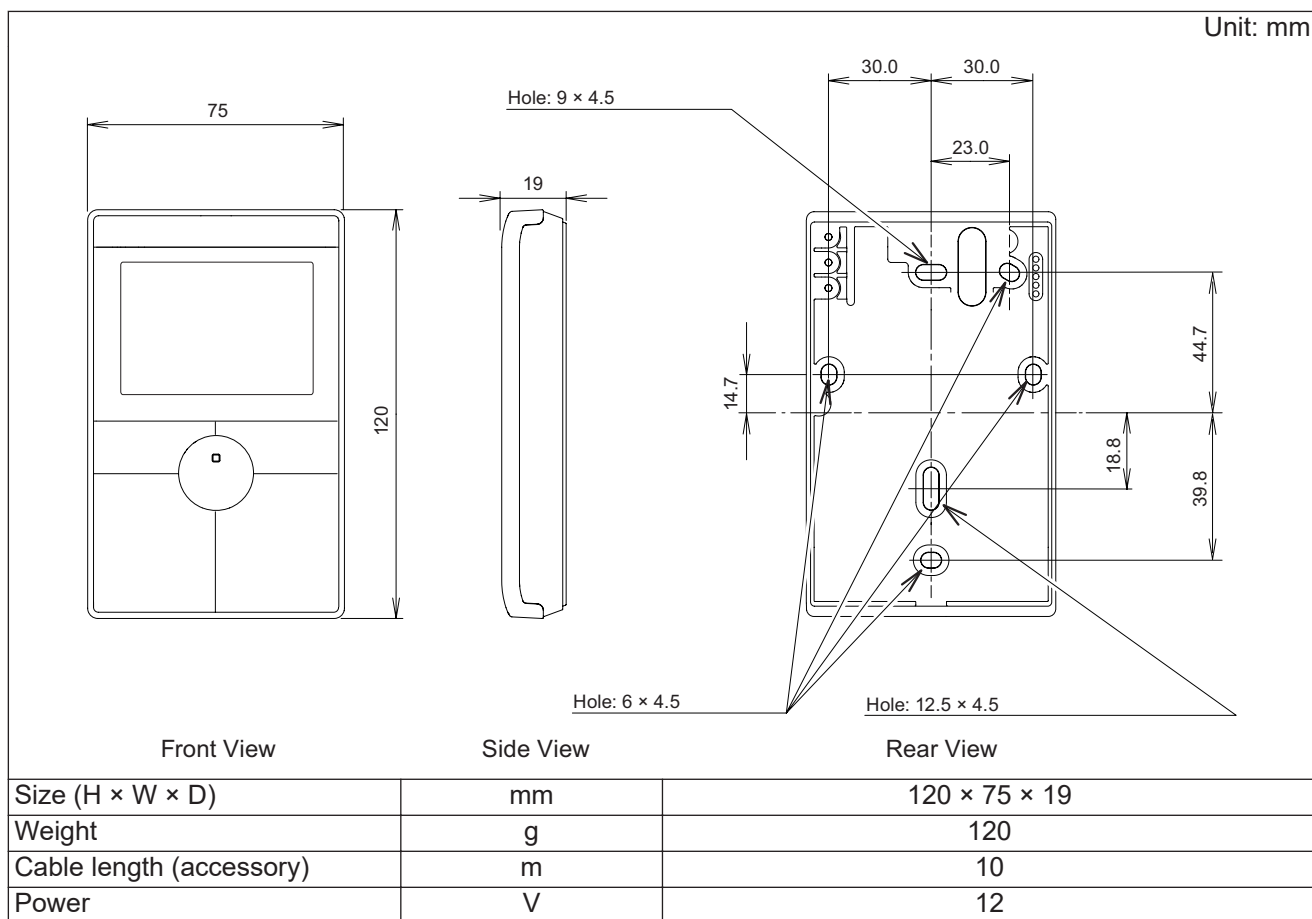

Wiring specifications

Use	Cable size	Wire type	Remarks
Remote controller cable	0.33 to 1.25 mm ²	Non-polar 2-core, Twisted pair	Use sheathed PVC cable.

Installation

Connect the end of remote controller cable directly to the exclusive terminal block.

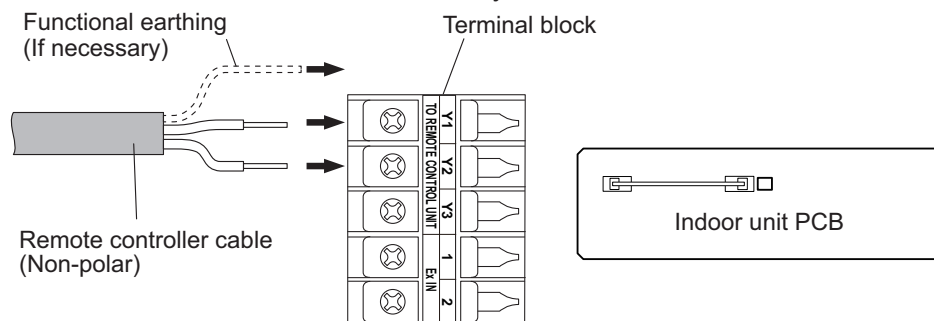

NOTES:

- Layout of terminal block and PCB is varies depending on the type of indoor unit.
- Operation may fail if it is connected to the outdoor unit or the terminal block for power supply.

14. Function settings

To adjust the functions of this product according to the installation environment, various types of function settings are available.

NOTE: Incorrect settings can cause a product malfunction.

14-1. Compact cassette, Mini duct, Slim duct types indoor unit (setting by DIP switch)

By using some components on the PCB, you can change the function settings.

Related components on the PCB and the applicable settings:

Component		Setting content	
DIP switch	SW100	1	Remote controller address setting
		2	
		3	
		4	
	SW101	1	Drainage function setting
		2	Auto louver grille setting
		3	Fan delay setting

■ Component location

Components on the indoor unit main PCB used for the function settings are located as shown in the following figure.

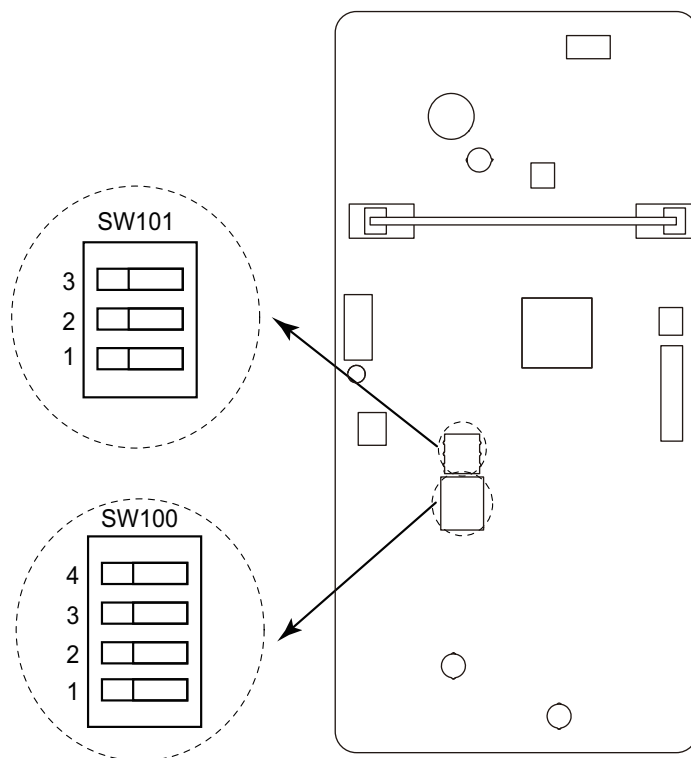

■ DIP switch setting

- **SW100: Remote controller address setting**

When operating a number of indoor units by using a wired remote controller, DIP switch setting for assigning unit number to each indoor unit is required.

The slide switches are normally set to make the unit number 00.

Remote controller address	Switch number				Factory setting
	1	2	3	4	
00	OFF	OFF	OFF	OFF	◆
01	ON	OFF	OFF	OFF	
02	OFF	ON	OFF	OFF	
03	ON	ON	OFF	OFF	
04	OFF	OFF	ON	OFF	
05	ON	OFF	ON	OFF	
06	OFF	ON	ON	OFF	
07	ON	ON	ON	OFF	
08	OFF	OFF	OFF	ON	
09	ON	OFF	OFF	ON	
10	OFF	ON	OFF	ON	
11	ON	ON	OFF	ON	
12	OFF	OFF	ON	ON	
13	ON	OFF	ON	ON	
14	OFF	ON	ON	ON	
15	ON	ON	ON	ON	

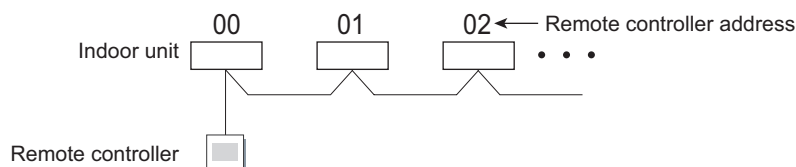

- **SW101-Switch 1: Drainage function setting**

Switch 1	Drainage function	Factory setting
ON	Disabled	
OFF	Enabled	◆

- **SW101-Switch 2: Auto louver grille setting**

When Auto louver grille kit (optional parts) is attached, set to "Enabled".

Switch 2	Auto louver grille setting	Factory setting
ON	Enabled	
OFF	Disabled	◆

- **SW101-Switch 3: Fan delay setting**

When the indoor unit is stopped while operating in conjunction with auxiliary heater, the indoor unit fan operation will continue for 1 minute.

Switch 3	Fan delay	Factory setting
ON	Enabled	
OFF	Disabled	◆

14-2. Indoor unit (setting by wireless remote controller)

⚠ CAUTION

This setting changes the function settings used to control the indoor unit according to the installation conditions. Incorrect settings can cause a product malfunction.

- After the power is turned on, perform the “Function setting” according to the installation conditions using the remote controller.
- The settings may be selected between the following two: Function number or Setting number.
- Settings will not be changed if invalid numbers or setting numbers are selected.

■ Preparation

Before connecting the power supply of the indoor unit, reconfirm following items:

- Piping air tight test and vacuuming have been performed firmly.
- There is no wiring mistake. Then, connect the power supply of the indoor unit.

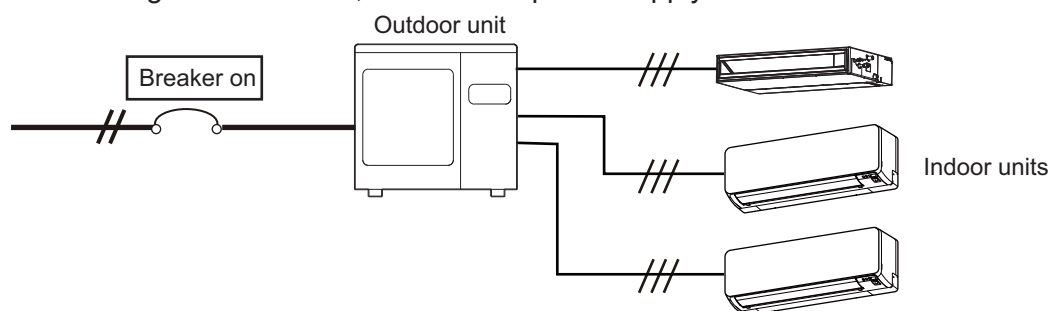

■ AR-REM4E (for Wall mounted type KGTB), AR-REW4E (for Wall mounted type KETA), AR-REW2E (for Wall mounted type KMTB), and AR-REM7E (for Floor type)

● Button name and function

During address setting mode, indoor unit reject the any operation command from remote controller.

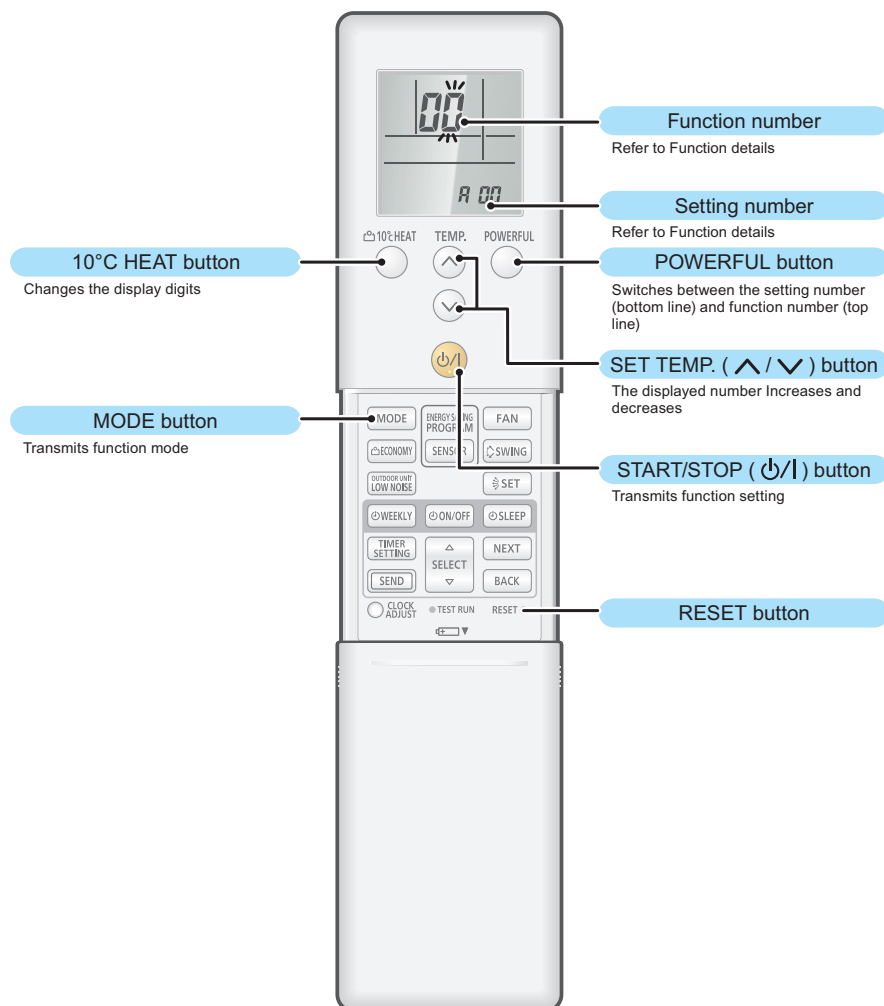

NOTE: The number of buttons varies by the remote controller model.

● Function setting procedure

1. Connect the power supply of the outdoor unit.

2. To enter the function setting mode, while holding down the POWERFUL and TEMP.^ button, press the RESET button.

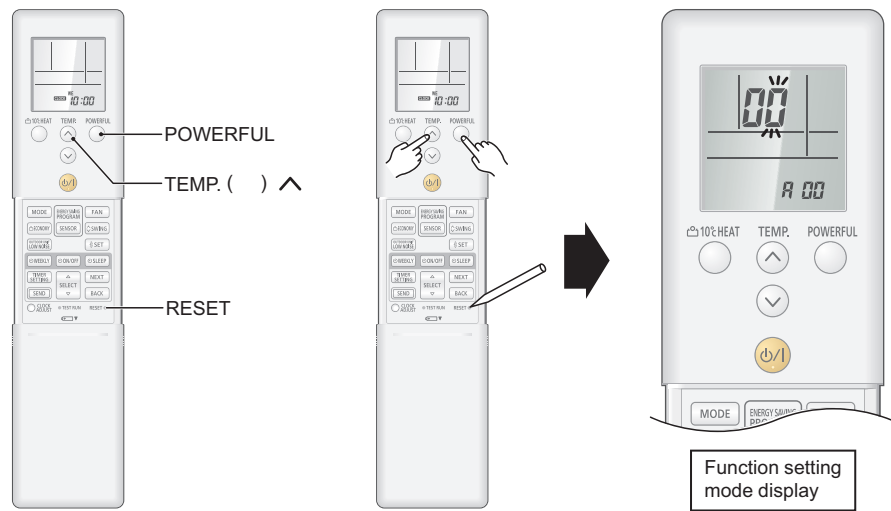

- Select the function number by pressing the \wedge or the \vee buttons. Each time the 10 °C HEAT button is pressed, it switches between the right digit and the left digit.

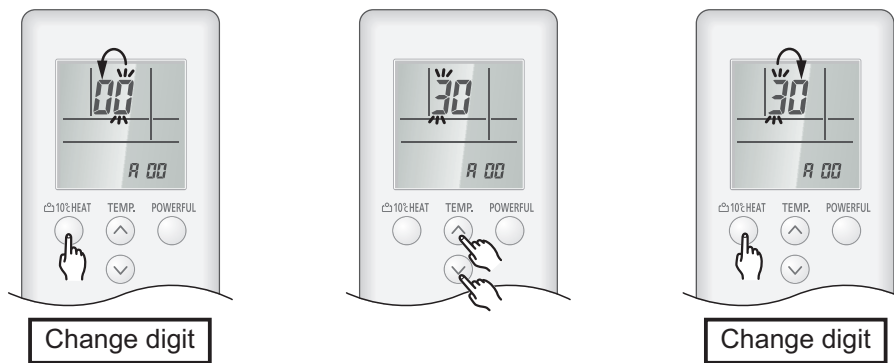

- Proceed to the setting number by pressing the POWERFUL button. (To return to the function number selection, press the POWERFUL button again.)



- Select the function number by pressing the \wedge or the \vee button. Each time the 10 °C HEAT button is pressed, it switches between the right digit and the left digit.

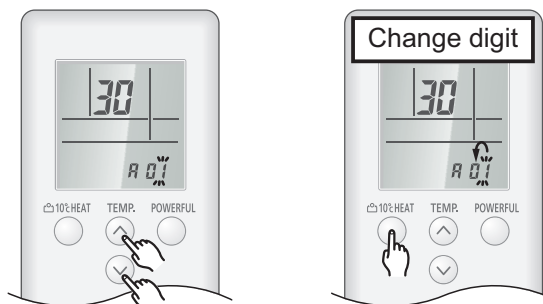

- Press the MODE button once to transmit the function mode information.

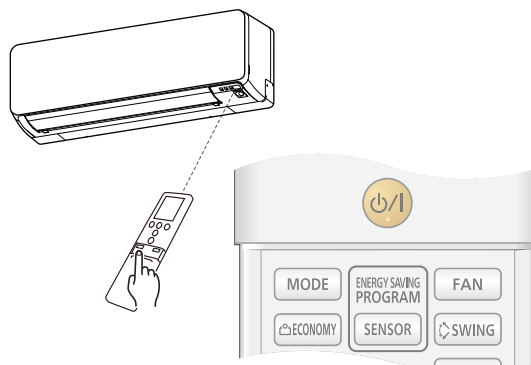

7. Press the $\phi/|$ button once to transmit the function setting information. 2 short beeps will be emitted from the indoor unit when the signal is received correctly. If wrong code is set, no beep sound will be emitted.

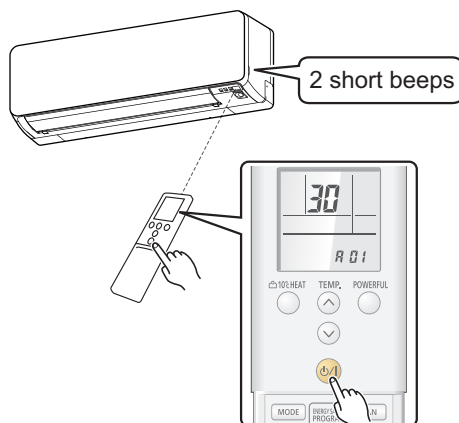

NOTE: Press $\phi/|$ button within 30 seconds after pressing MODE button.

For the function details, refer to Chapter 14-5. "[Function details](#)" on page 268.

8. Exit the function setting mode by pressing the RESET button.

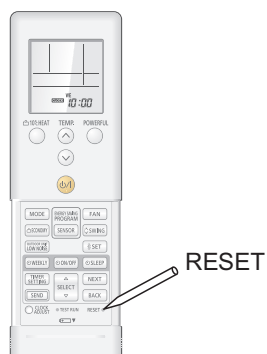

● Setting up each indoor unit

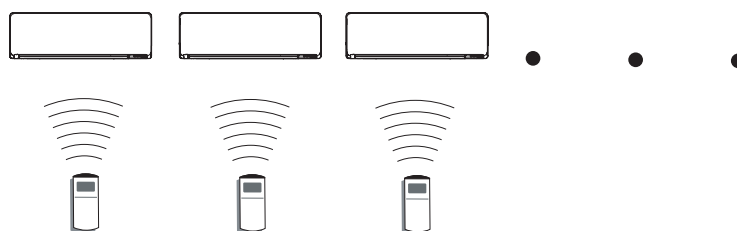

Repeat step from 1. to 8. to set up each indoor unit. If the custom code is other than "F", steps from 1. to 2. and 8. need to be performed.

● Resetting the power after setting up all indoor units

Important:

- If the reset is not performed, function cannot be read correctly.
- After all the functions have been set, the circuit breaker needs to be switched off for at least 2 minutes.
 - After the 2 minutes has passed, power can be restored.
 - The set function is stored in the PCB and will remain in memory even when the power of indoor unit is turned off.
However setting function is effective after disconnecting the power supply and then reconnecting it.
- Record the latest configuration of the indoor unit function setting on a label, and put the label on the unit so it can be used for after-sales service operations.

Once the RESET button is pressed on the remote controller, the operation mode will be set to the AUTO MODE.

Adjust the operation mode to either cooling or heating before starting the operation of the air conditioner.

NOTE: If custom code other than "F" is set, the remote control must be set accordingly to the indoor unit setting.

● Remote controller custom code setting

Custom code setting of wireless remote controller needs to be same as the setting of the indoor unit. When you change the custom code setting of the wireless remote controller, do as follows:

1. Press the START/STOP button until only the clock is displayed on the display.



2. Press the MODE button for at least 5 seconds to display the current custom code (initially set to A).



3. Press the TEMP. “ ^ ” or the “ v ” button to change the custom code between A → b → c → d.

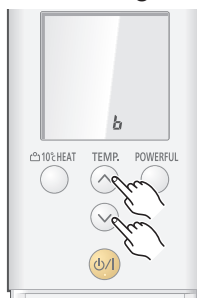

4. Press the MODE button again to return to the clock display. The custom code will be changed.

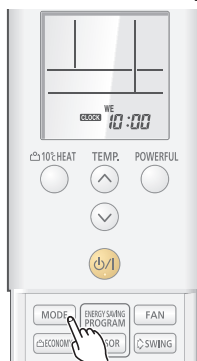

- If no buttons are pressed within 30 seconds after the custom code is displayed, the system returns to the original clock display. In this case, start again from step 1.
- The air conditioner custom code is set to A prior to shipment.
- If you do not know the air conditioner custom code setting, try each of the custom codes (A → b → c → d) until you find the code which operates the air conditioner.

■ AR-REB1E (for Wall mounted type KMCC)

● Button name and function

During address setting mode, indoor unit reject the any operation command from remote controller.

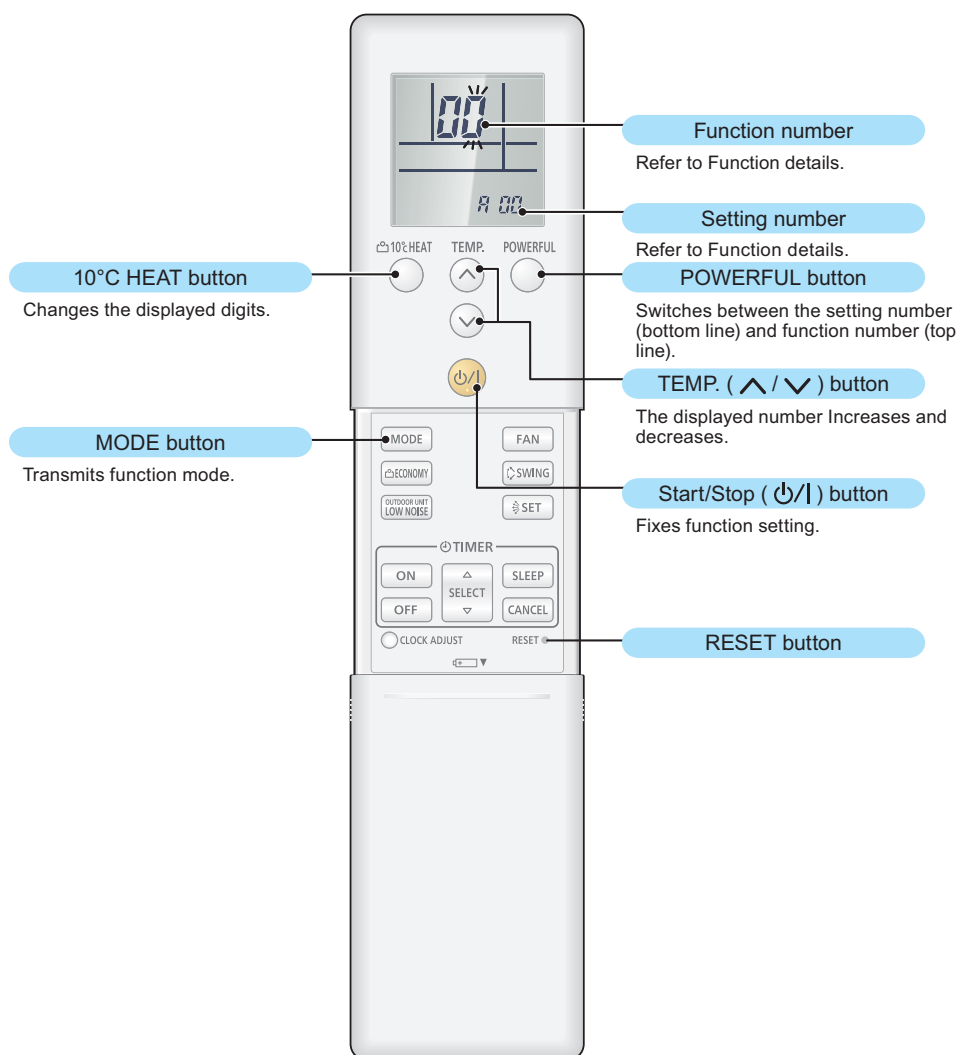

● Function setting procedure

1. Connect the power supply of the outdoor unit.
2. To enter the function setting mode, while holding down the POWERFUL and SET TEMP. ^ buttons, press the RESET button.

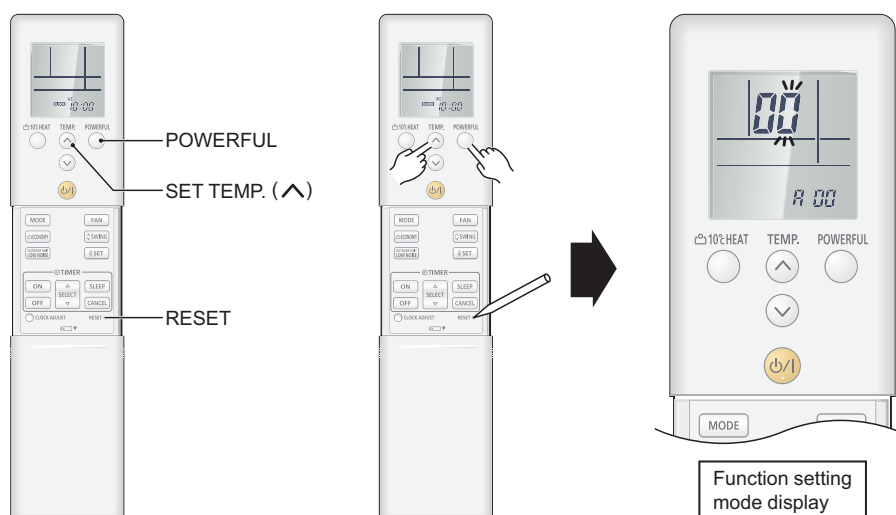

3. Select the function number by pressing the \wedge or the \vee buttons. Each time the 10°C HEAT button is pressed, it switches between the right digit and the left digit.



4. Proceed to the setting number by pressing the POWERFUL button. (To return to the function number selection, press the POWERFUL button again.)



5. Select the function number by pressing the \wedge or the \vee button. Each time the 10°C HEAT button is pressed, it switches between the right digit and the left digit.

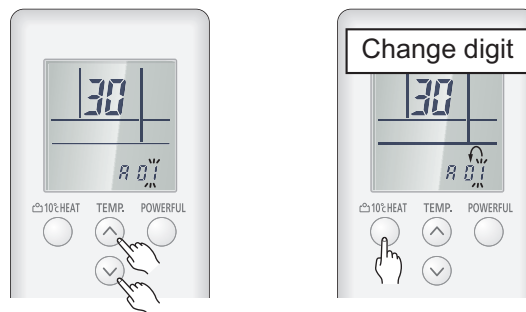

6. Press the MODE button once to transmit the function mode information.

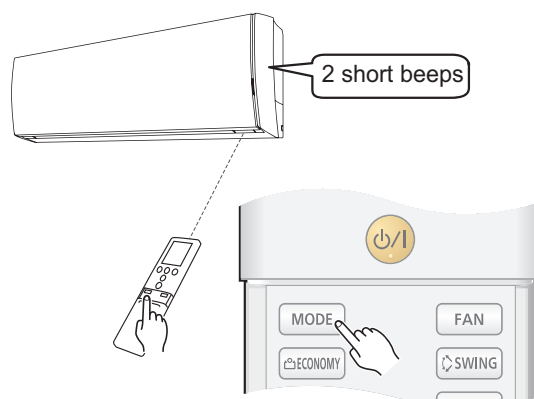

7. Press the ϕ/I button once to transmit the function setting information. 2 short beeps will be emitted from the indoor unit when the signal is received correctly. If wrong code is set, no beep sound will be emitted.

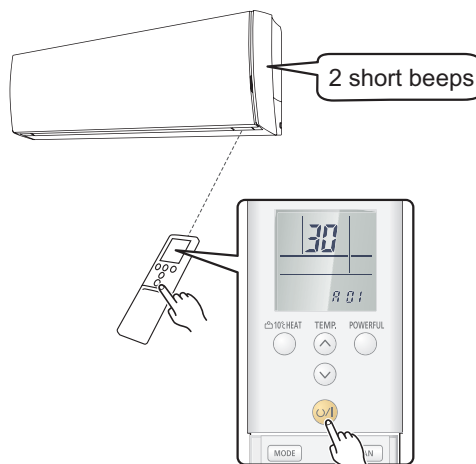

NOTE: Press ϕ/I button within 30 seconds after pressing MODE button.

For the function details, refer to Chapter 14-5. "[Function details](#)" on page 268.

8. Exit the function setting mode by pressing the RESET button.

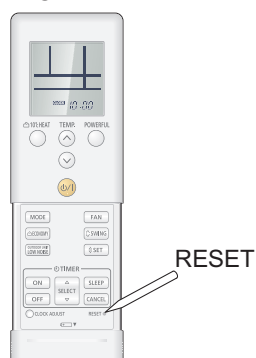

● Setting up each indoor unit

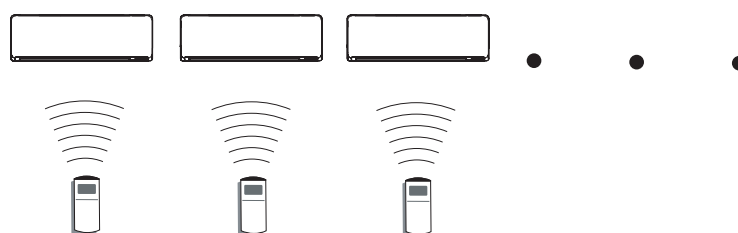

Repeat step from 1. to 8. to set up each indoor unit. If the custom code is other than "A", steps from 1. to 2. and 8. need to be performed.

● Resetting the power after setting up all indoor units

Important:

- If the reset is not performed, function cannot be read correctly.
- After all the functions have been set, the circuit breaker needs to be switched off for at least 2 minutes.
 - After the 2 minutes has passed, power can be restored.
 - The set function is stored in the PCB and will remain in memory even when the power of indoor unit is turned off.
However setting function is effective after disconnecting the power supply and then reconnecting it.
- Record the latest configuration of the indoor unit function setting on a label, and put the label on the unit so it can be used for after-sales service operations.

Once the RESET button is pressed on the remote controller, the operation mode will be set to the AUTO MODE.

Adjust the operation mode to either cooling or heating before starting the operation of the air conditioner.

NOTE: If custom code other than "F" is set, the remote control must be set accordingly to the indoor unit setting.

● Remote controller custom code setting

Custom code setting of wireless remote controller needs to be same as the setting of the indoor unit. When you change the custom code setting of the wireless remote controller, do as follows:

1. Press the START/STOP button until only the clock is displayed on the display.



2. Press the MODE button for at least 5 seconds to display the current custom code (initially set to A).



3. Press the SET TEMP. “ ^ ” or the “ v ” button to change the custom code between A → b → c → d.



4. Press the MODE button again to return to the clock display. The custom code will be changed.



- If no buttons are pressed within 30 seconds after the custom code is displayed, the system returns to the original clock display. In this case, start again from step 1.
- The air conditioner custom code is set to A prior to shipment.
- If you do not know the air conditioner custom code setting, try each of the custom codes (A → b → c → d) until you find the code which operates the air conditioner.

■ UTY-LNTY (for Compact cassette type) or AR-REJ1E (included in UTY-LBTYM for Duct type)

● Button name and function

During address setting mode, indoor unit reject the any operation command from remote controller.

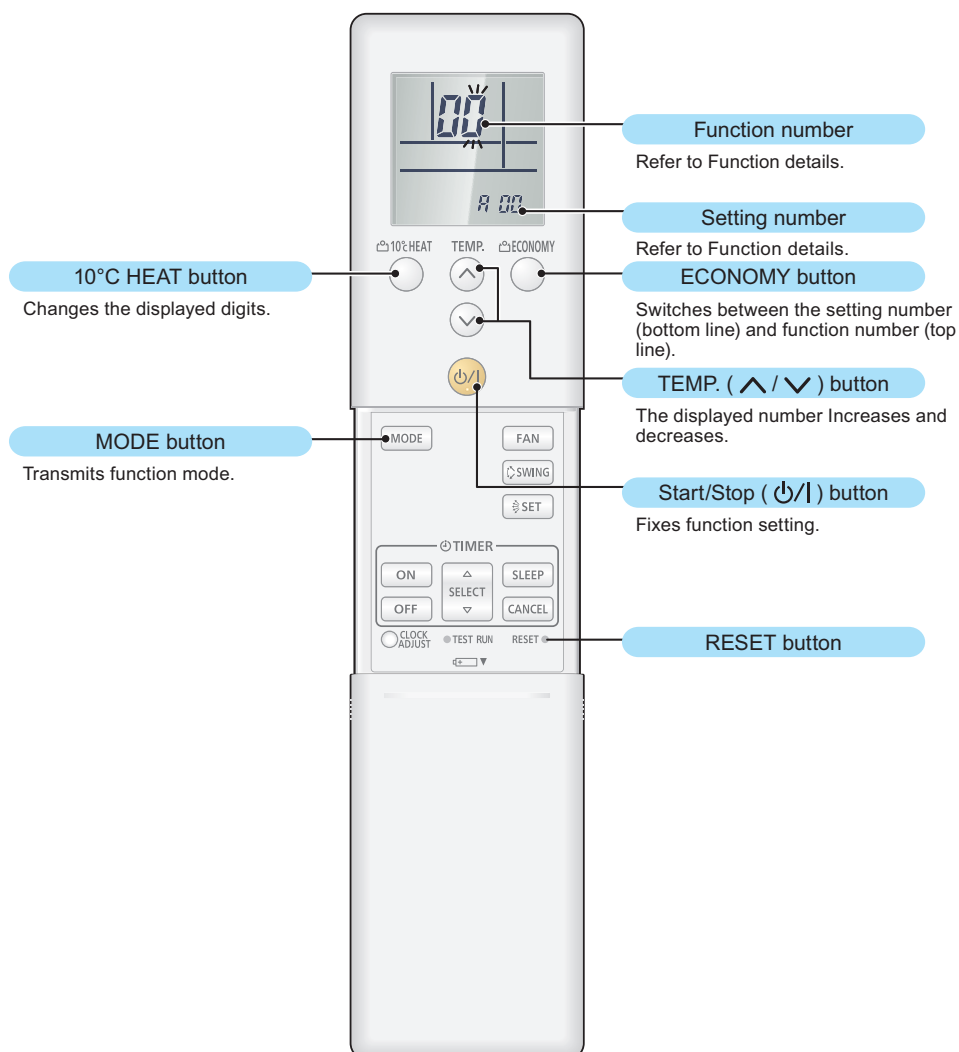

● Function setting procedure

1. Connect the power supply of the outdoor unit.
2. To enter the function setting mode, while holding down the ECONOMY and SET TEMP. ^ buttons, press the RESET button.

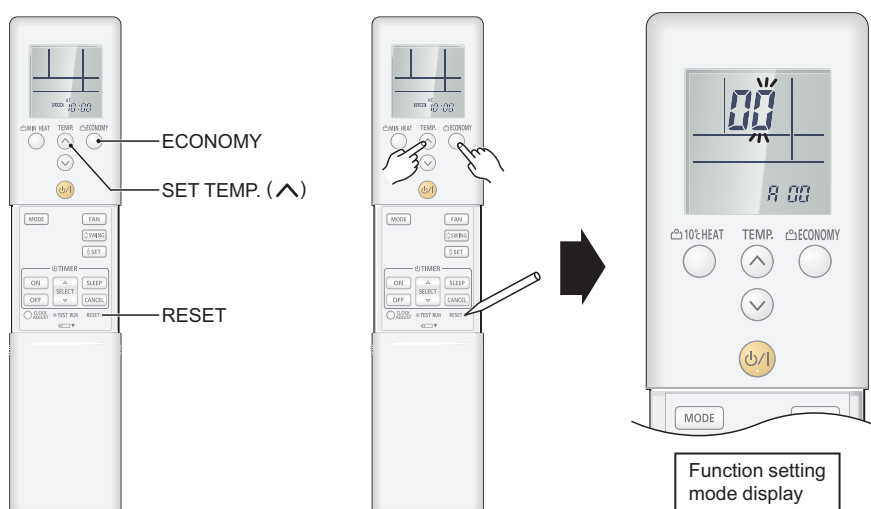

3. Select the function number by pressing the \wedge or the \vee buttons. Each time the 10°C HEAT button is pressed, it switches between the right digit and the left digit.



4. Proceed to the setting number by pressing the ECONOMY button. (To return to the function number selection, press the ECONOMY button again.)

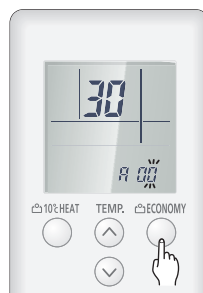

5. Select the function number by pressing the \wedge or the \vee button. Each time the 10°C HEAT button is pressed, it switches between the right digit and the left digit.

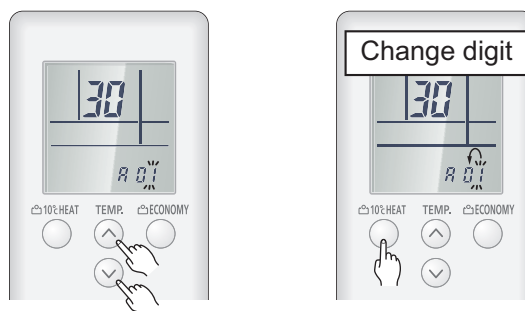

6. Press the MODE button once to transmit the function mode information.

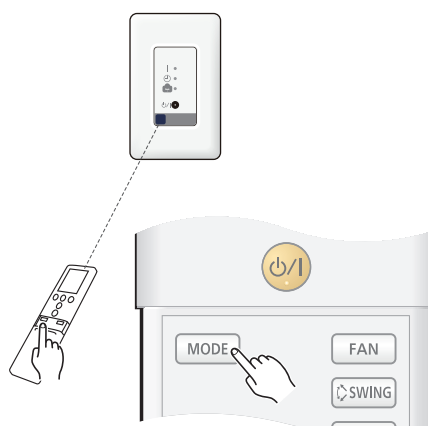

7. Press the $\phi/|$ button once to transmit the function setting information. 1 short beep will be emitted from the indoor unit or the IR receiver when the signal is received correctly. If wrong code is set, no beep sound will be emitted.

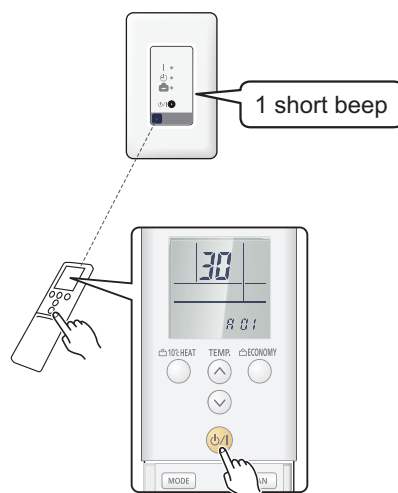

NOTE: Press $\phi/|$ button within 30 seconds after pressing MODE button.

For the function details, refer to Chapter 14-5. "[Function details](#)" on page 268.

8. Exit the function setting mode by pressing the RESET button.

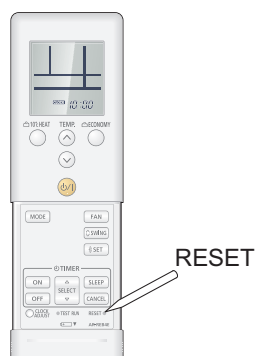

● Setting up each indoor unit

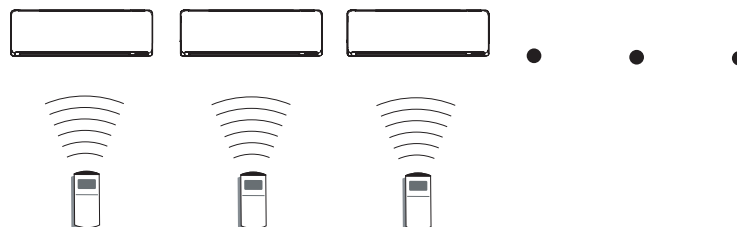

Repeat step from 1. to 8. to set up each indoor unit. If the custom code is other than "F", steps from 1. to 2. and 8. need to be performed.

● Resetting the power after setting up all indoor units

Important:

- If the reset is not performed, function cannot be read correctly.
- After all the functions have been set, the circuit breaker needs to be switched off for at least 2 minutes.
 - After the 2 minutes has passed, power can be restored.
 - The set function is stored in the PCB and will remain in memory even when the power of indoor unit is turned off. However setting function is effective after disconnecting the power supply and then reconnecting it.
- Record the latest configuration of the indoor unit function setting on a label, and put the label on the unit so it can be used for after-sales service operations.

Once the RESET button is pressed on the remote controller, the operation mode will be set to the AUTO MODE.

Adjust the operation mode to either cooling or heating before starting the operation of the air conditioner.

NOTE: If custom code other than "F" is set, the remote control must be set accordingly to the indoor unit setting.

● Remote controller custom code setting

Custom code setting of wireless remote controller needs to be same as the setting of the indoor unit. When you change the custom code setting of the wireless remote controller, do as follows:

1. Press the START/STOP button until only the clock is displayed on the display.

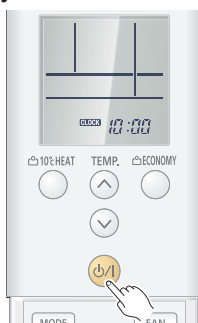

2. Press the MODE button for at least 5 seconds to display the current custom code (initially set to A).
3. Press the SET TEMP. “ ^ ” or the “ v ” button to change the custom code between A → B → C → D.

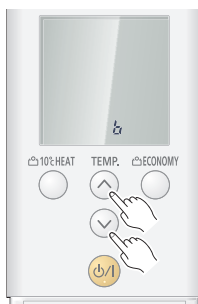

4. Press the MODE button again to return to the clock display. The custom code will be changed.



- If no buttons are pressed within 30 seconds after the custom code is displayed, the system returns to the original clock display. In this case, start again from step 1.
- The air conditioner custom code is set to A prior to shipment.
- If you do not know the air conditioner custom code setting, try each of the custom codes (A → B → C → D) until you find the code which operates the air conditioner.

14-3. Indoor unit (setting by wired remote controller)

- The function settings of the control of the indoor unit can be changed by this procedure according to the installation conditions. Incorrect settings can cause the indoor unit malfunction.
- After the power is turned on, perform the “Function setting” according to the installation conditions using the remote controller.
- The settings may be selected between the following two: Function number or Setting number.
- Settings will not be changed if invalid numbers or setting numbers are selected.
- This function cannot be used on the secondary units.

■ Preparation

Before connecting the power supply of the indoor unit, reconfirm following items:

- Piping air tight test and vacuuming have been performed firmly.
- There is no wiring mistake. Then, connect the power supply of the indoor unit.

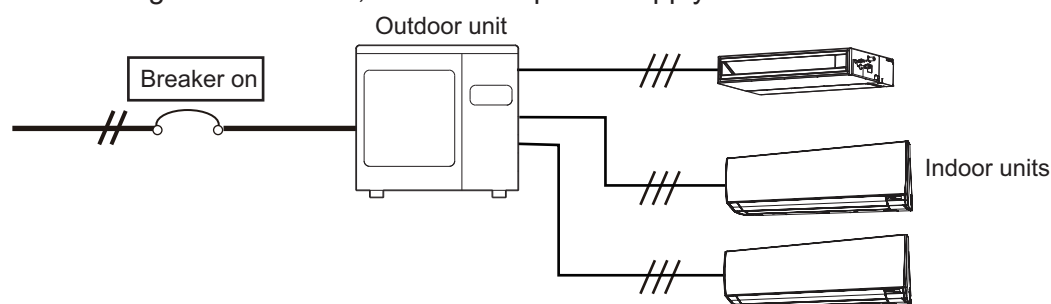

■ UTY-RNNYM

● Button name and function

During address setting mode, indoor unit reject the any operation command from remote controller.

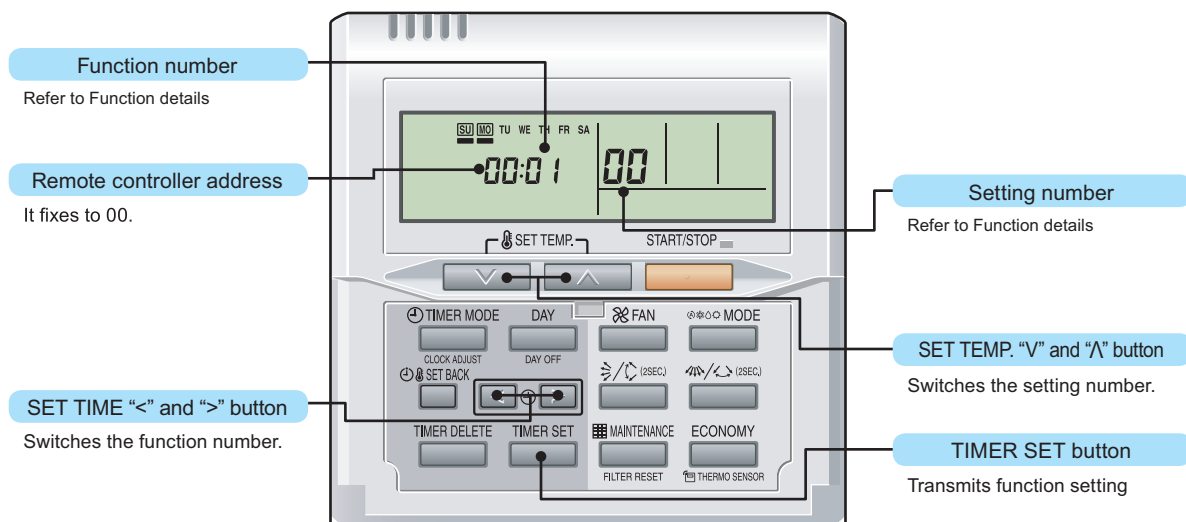

● Function setting procedure

1. Connect the power supply of the outdoor unit.
2. Switch to the function setting mode.

To enter the function setting mode, hold down the 3 buttons of SET TEMP. ∇, SET TEMP. ▲, and FAN at the same time for 5 seconds or longer.

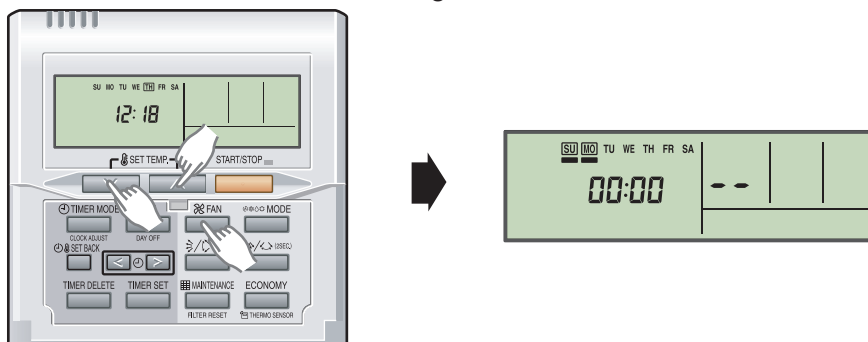

3. Select the function number by pressing the SET TIME < or the SET TIME > button.

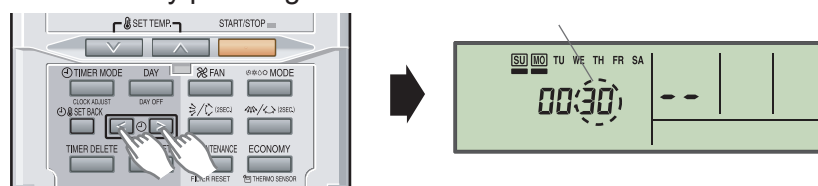

4. Select the setting number by pressing the SET TEMP. ▲ or the SET TEMP. ∇ button. The display flashes during setting number selection.

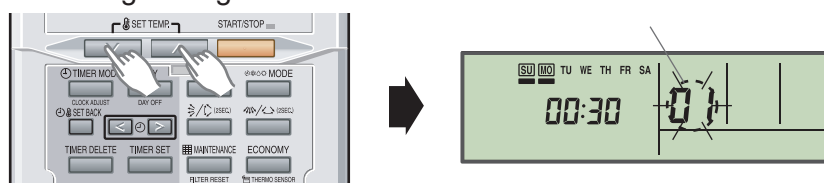

5. Confirm the setting by pressing the TIMER SET button.
The data will be transferred to the indoor unit.

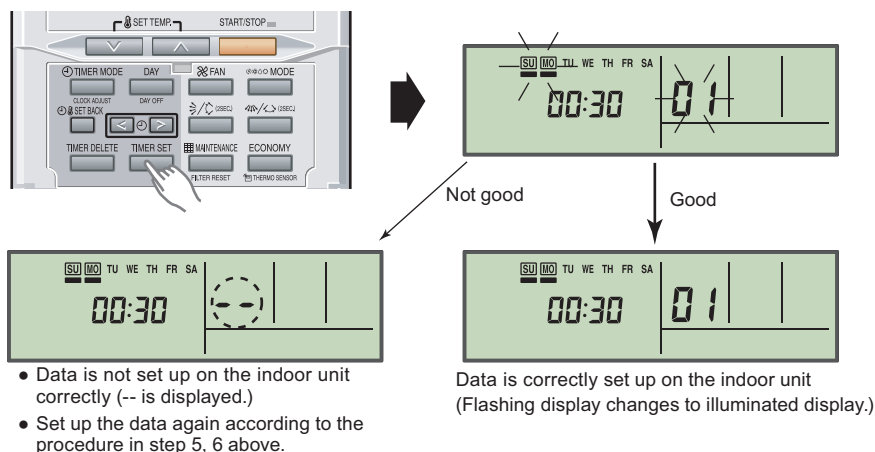

Function details: Refer to Chapter 14-5. "[Function details](#)" on page 268.

6. Exit the function setting mode by holding 3 buttons of SET TEMP. ∇ , SET TEMP. \wedge and FAN at the same time.

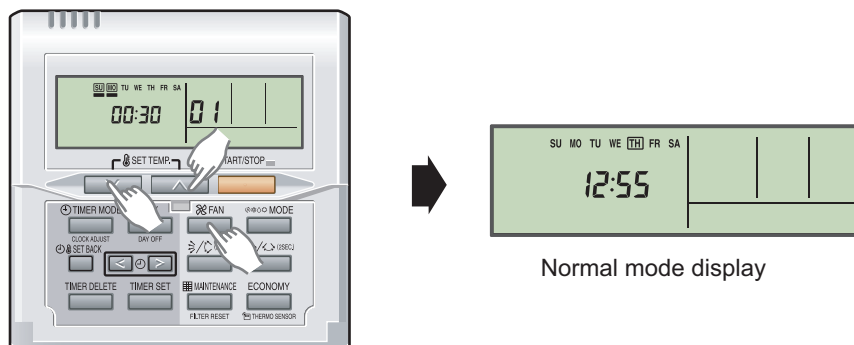

If no button is pressed within 60 seconds after buttons mentioned above are pressed, it will automatically exit the function setting mode.

If you exit the function setting mode unintentionally during setting, enter the mode again according to the procedure in step 2.

● Setting up each indoor unit

Repeat the procedures from step 1 to 6, and set up the indoor units requiring function setting.

● Resetting the power after setting up function of all indoor units

NOTES:

- If the reset is not performed, function cannot be read correctly.
- After all the functions have been set, the circuit breaker needs to be switched off for at least 2 minutes.
 - After the 2 minutes has passed, power can be restored.
 - The set function is stored in the PCB and will remain in memory even when the power of indoor unit is turned off.
However setting function is effective after disconnecting the power supply and then reconnecting it.
- Record the latest configuration of the indoor unit function setting on a label, and put the label on the unit so it can be used for after-sales service operations.

■ UTY-RLRY

● Setting procedure by using wired remote controller

The function number and the associated setting value are displayed on the LCD of the remote controller. Follow the instructions written in the local setup procedure supplied with the remote controller, and select appropriate setting according to the installation environment.

Before connecting the power supply of the indoor unit, reconfirm following items:

- Piping air tight test and vacuuming have been performed firmly.
 - There is no wiring mistake.
1. Connect the power supply.
 2. To activate the address setting mode, hold down the three buttons of “MENU”, “<”, and “ENTER” at the same time for 2 seconds or longer. Menu 2 setting screen is displayed.

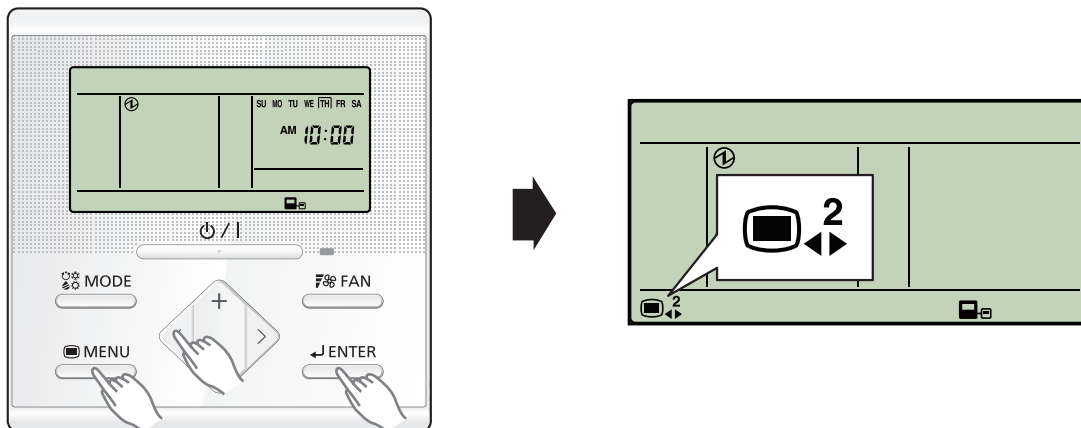

3. Select the “13” in Menu 2 settings. Then press the “ENTER” button.

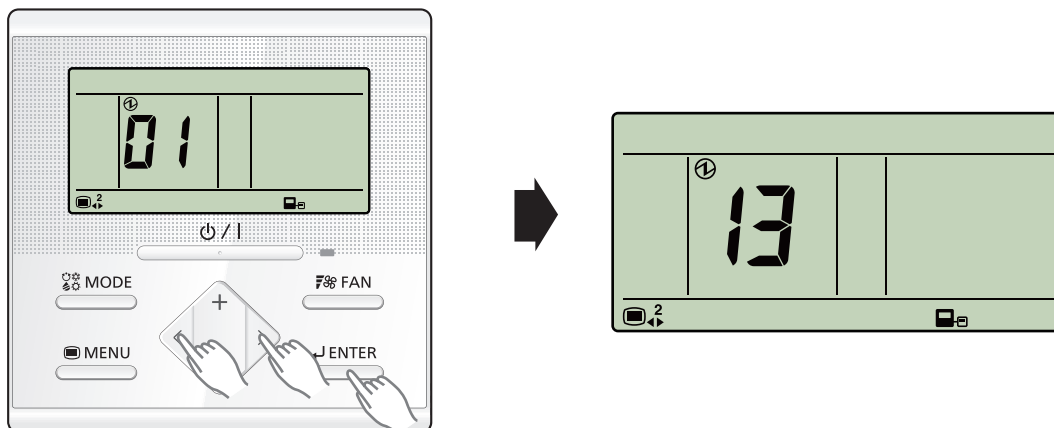

4. Pressing the “+” or “-” button, select a remote controller address (select the indoor unit you want to operate). Then press the “ENTER” button.

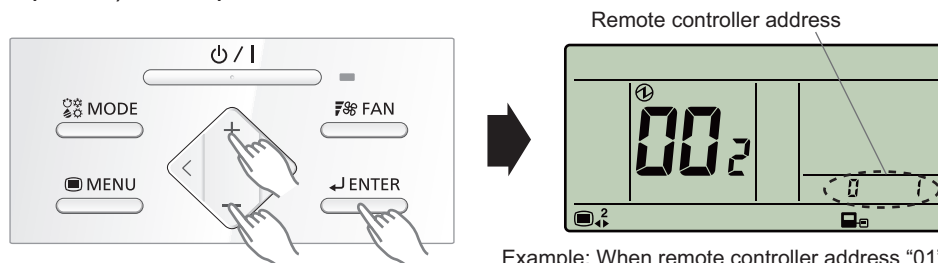

Example: When remote controller address “01” is selected.

5. Pressing the "+" or "-" button, to select the function number. Then press the "ENTER" button.

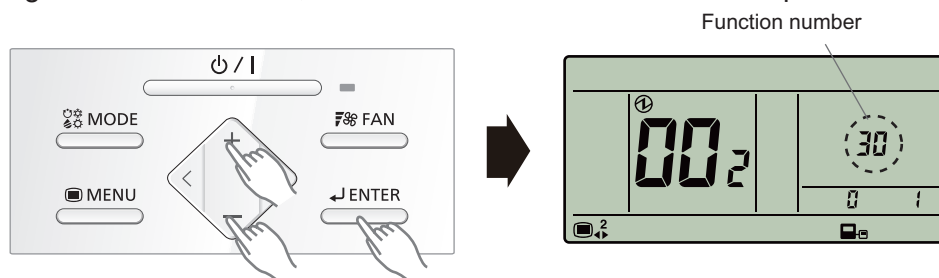

6. Pressing the "+" or "-" button, to select the setting number. Then press the "ENTER" button.

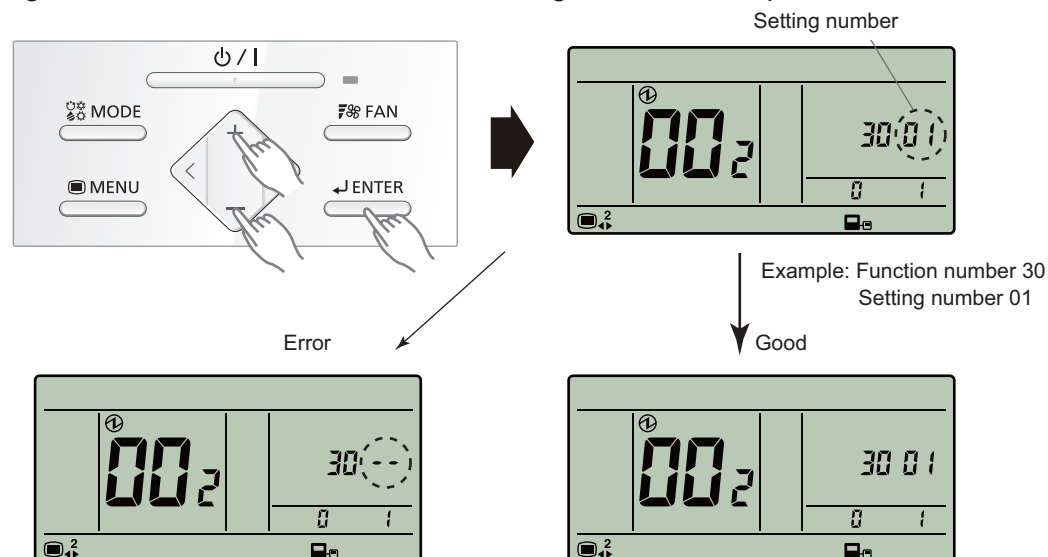

• When the data was not set up on the indoor unit ("--" is displayed.)

• Set up the data again.

• When the data was normally set up on the indoor unit.

Pressing the "ENTER" button to return to the address selection screen.

If setting has been completed, pressing the "MENU" button to return to the Menu 2 item selection screen.

● Setting up each indoor unit

Repeat the procedure from step 1 to 6, and set up the indoor units requiring function setting.

● Resetting the power after setting up function of all indoor units

NOTES:

- If the reset is not performed, function cannot be read correctly.
- After all the functions have been set, the circuit breaker needs to be switched off for at least 2 minutes.
 - After the 2 minutes has passed, power can be restored.
 - The set function is stored in the PCB and will remain in memory even when the power of indoor unit is turned off. However setting function is effective after disconnecting the power supply and then reconnecting it.
- Record the latest configuration of the indoor unit function setting on a label, and put the label on the unit so it can be used for after-sales service operations.

■ UTY-RVNYM

● Function setting procedure

1. Connect the power supply of the outdoor unit.
2. Switch to the function setting mode.

When [Menu button] is pressed twice while “Monitor” screen is displayed, it switches to the “Submenu” screen. If [Menu button] is pressed while the “Submenu” screen is displayed, the display returns to the “Monitor” screen.

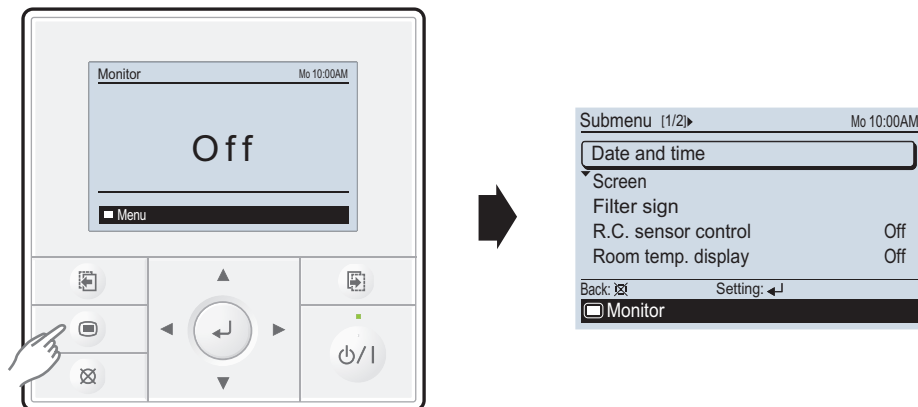

Press the [Screen switch button (Left)] and [Screen switch button (Right)] simultaneously for 5 seconds to switch to “Service” screen.

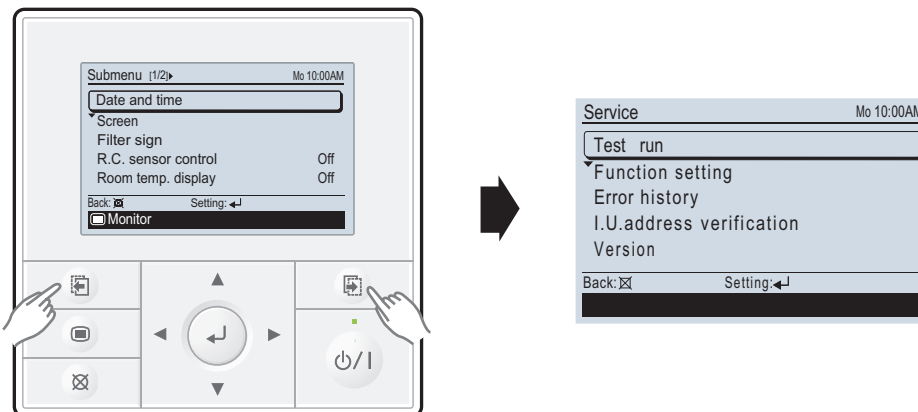

Select [Function setting] with pressing the [Cursor button (Up/Down)], and press the [Enter button].

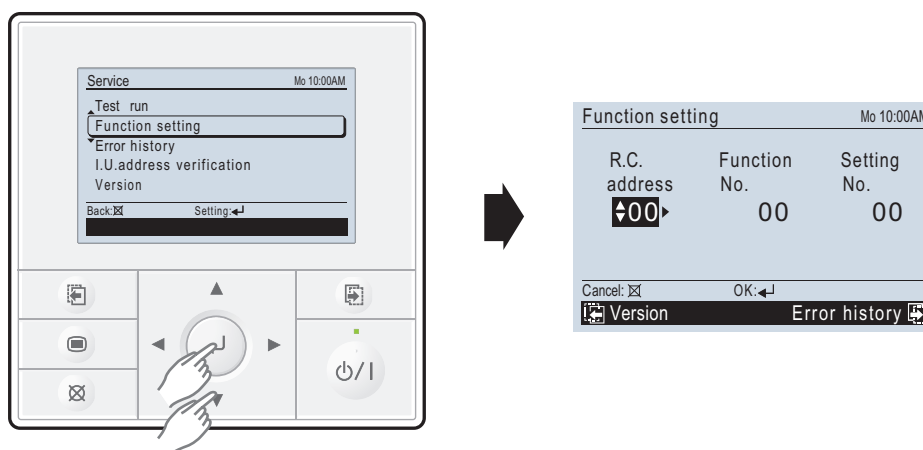

3. Select the [Function No.] with pressing the [Cursor button (Left/Right)], and select the Function No. to be set with pressing the [Cursor button (Up/Down)].

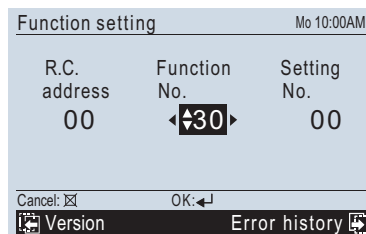
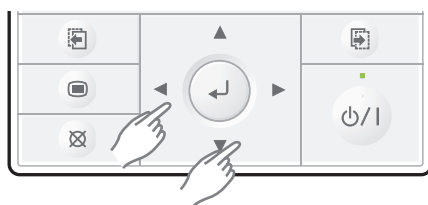

4. Select the [Setting No.] with pressing the [Cursor button (Left/Right)], and select the Setting No. to be set with pressing the [Cursor button (Up/Down)].

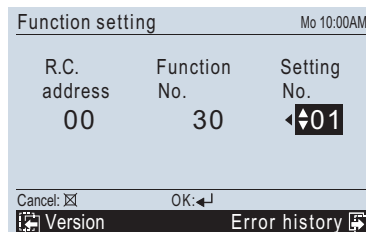
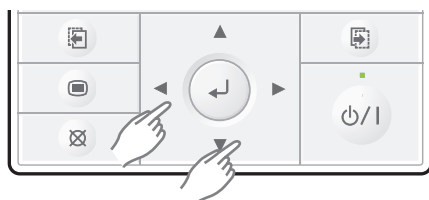

5. Pressing the [Enter button], confirm the setting. The data will be transferred to the indoor unit.

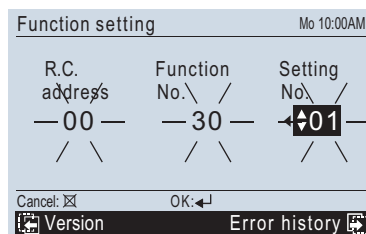
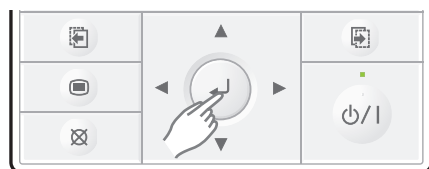

Error

Good

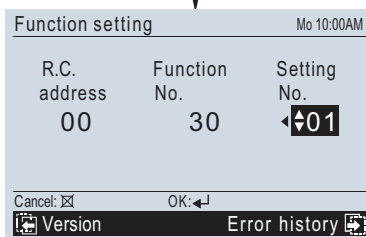
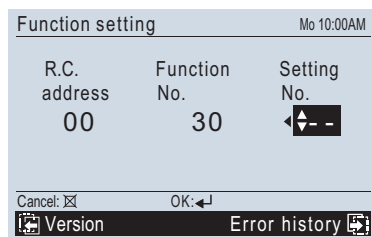

Function details: Refer to Chapter 14-5. "Function details" on page 268.

6. When [Cancel button] is pressed twice while “Function setting” screen is displayed, it switches to the “Submenu” screen.

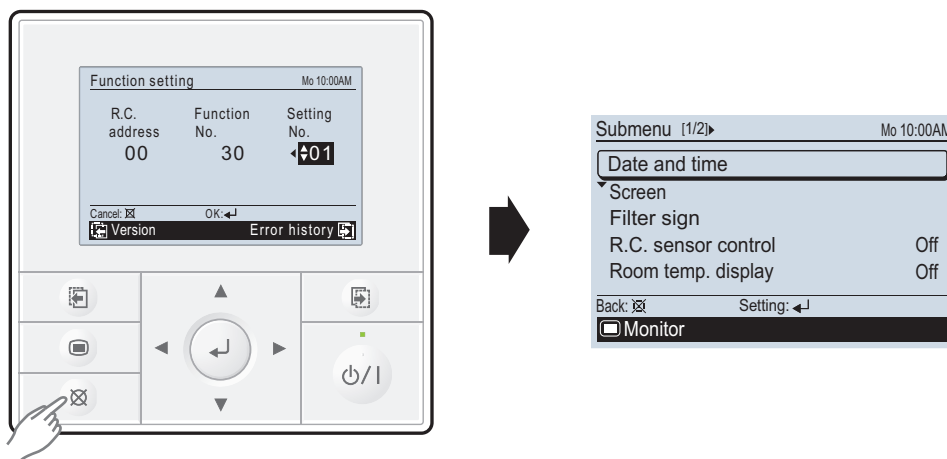

If no button is pressed within 60 seconds after buttons mentioned above are pressed, it will automatically exit the function setting mode.

If you exit the function setting mode unintentionally during setting, enter the mode again according to the procedure in step 2.

● Setting up each indoor unit

Repeat the procedures from step 1 to 6, and set up the indoor units requiring function setting.

● Resetting the power after setting up function of all indoor units

NOTES:

- If the reset is not performed, function cannot be read correctly.
- After all the functions have been set, the circuit breaker needs to be switched off for at least 2 minutes.
 - After the 2 minutes has passed, power can be restored.
 - The set function is stored in the PCB and will remain in memory even when the power of indoor unit is turned off.

However setting function is effective after disconnecting the power supply and then reconnecting it.
- Record the latest configuration of the indoor unit function setting on a label, and put the label on the unit so it can be used for after-sales service operations.

■ UTY-RNRYZ*

● Setting procedure by using wired remote controller

The function number and the associated setting value are displayed on the LCD of the remote controller. Follow the instructions written in the local setup procedure supplied with the remote controller, and select appropriate setting according to the installation environment.

Before connecting the power supply of the indoor unit, reconfirm following items:

- Piping air tight test and vacuuming have been performed firmly.
 - There is no wiring mistake.
1. Connect the power supply.
 2. When the “Function Setting” on the “Maintenance” screen is touched, the “Installer Password Verification” screen is displayed. After enter the installer password, and touch the “OK”, “Function Setting” screen is displayed.

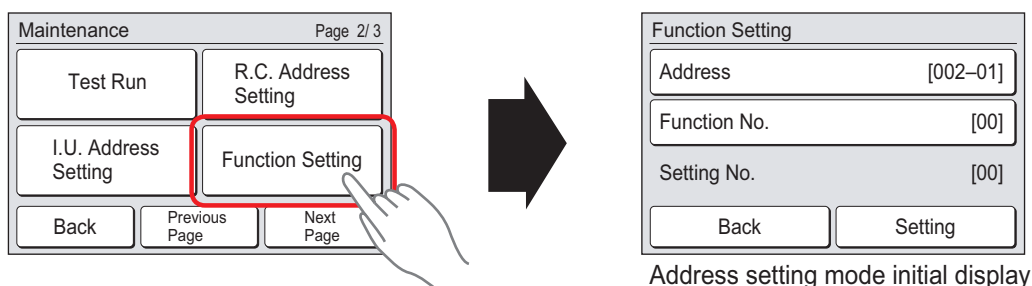

3. Touch the “Address” on the “Function Setting” screen.

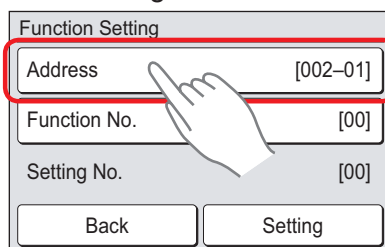

4. “Address” screen is displayed. Select the address of the indoor unit whose function number is to be set by touching ▲ or ▼. When setting at all the indoor units, touch “All”.

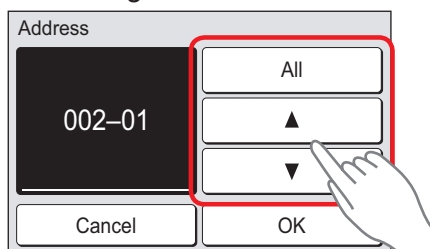

When the “OK” is touched, the display returns to the “Function Setting” screen.

5. Touch the “Function No.” on the “Function Setting” screen.

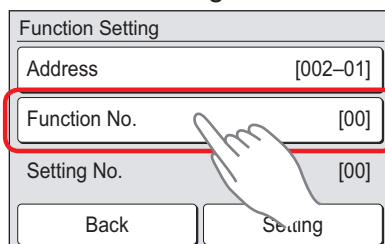

6. "Function No." screen is displayed. Set the "Function No." with ▲ or ▼.

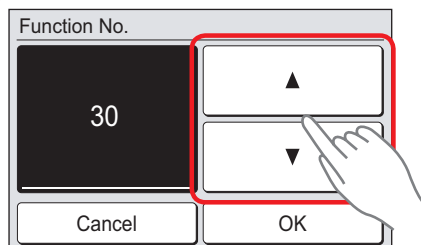

When the "OK" is touched, the display returns to the "Function Setting" screen.

7. Touch the "Function No." on the "Function Setting" screen.

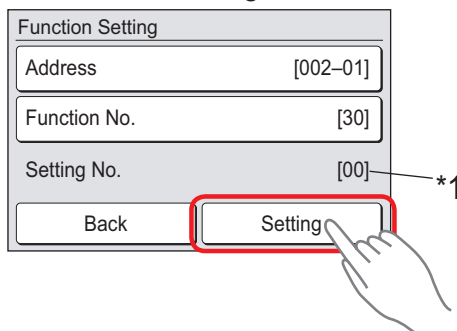

NOTE: *1: When "All" is chosen by "5", and different set up "Setting No." from two or more indoor units, "-" is displayed on "Setting No.".

8. Setting screen of "Setting No." is displayed. Set the "Function No." with ▲ or ▼.

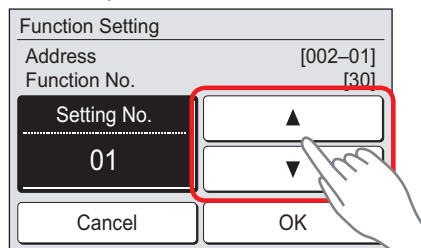

Example: Function number: 30, Setting Number: 01

When the "OK" is touched, the "Function Setting" verification screen is displayed.

9. Touch the "Yes" of the verification screen.

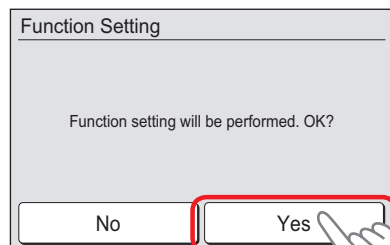

In case of "OK"

In case of "ERROR"

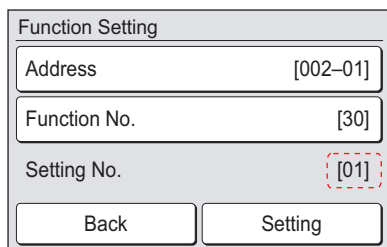

When the data was normally set up on the indoor unit

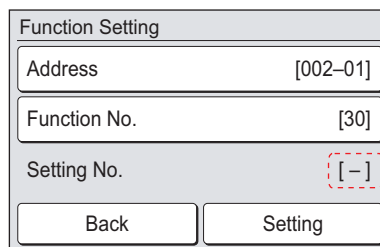

When the data was not set up on the indoor unit ([-] is displayed.), set up the data again according to the procedure in step 4 to 7 above

10. When the "Back" on the "Function Setting" screen is touched, the display returns to the "Maintenance" screen.

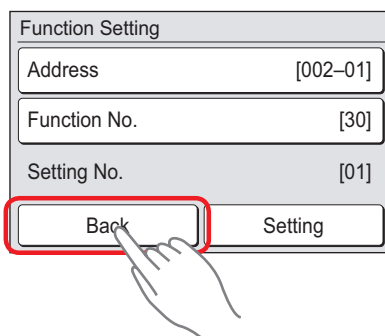

● Setting up each indoor unit

Repeat the procedure from step 1 to 6, and set up the indoor units requiring function setting.

● Resetting the power after setting up function of all indoor units

NOTES:

- If the reset is not performed, function cannot be read correctly.
- After all the functions have been set, the circuit breaker needs to be switched off for at least 2 minutes.
 - After the 2 minutes has passed, power can be restored.
 - The set function is stored in the PCB and will remain in memory even when the power of indoor unit is turned off. However setting function is effective after disconnecting the power supply and then reconnecting it.
- Record the latest configuration of the indoor unit function setting on a label, and put the label on the unit so it can be used for after-sales service operations.

14-4. Indoor unit (setting by simple remote controller)

- The function settings of the control of the indoor unit can be changed by this procedure according to the installation conditions. Incorrect settings can cause the indoor unit malfunction.
- After the power is turned on, perform the “Function setting” according to the installation conditions using the remote controller.
- The settings may be selected between the following two: Function number or Setting number.
- Settings will not be changed if invalid numbers or setting numbers are selected.
- This function cannot be used on the secondary units.

■ Preparation

Before connecting the power supply of the indoor unit, reconfirm following items:

- Piping air tight test and vacuuming have been performed firmly.
- There is no wiring mistake. Then, connect the power supply of the indoor unit.

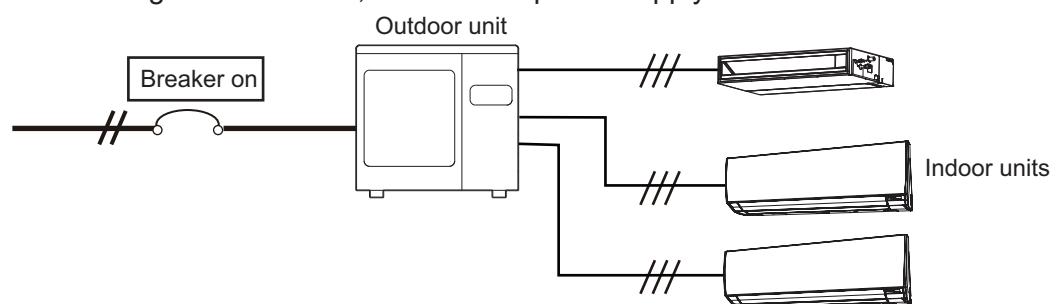

■ UTY-RSNYM

● Button name and function

During address setting mode, indoor unit reject the any operation command from remote controller.

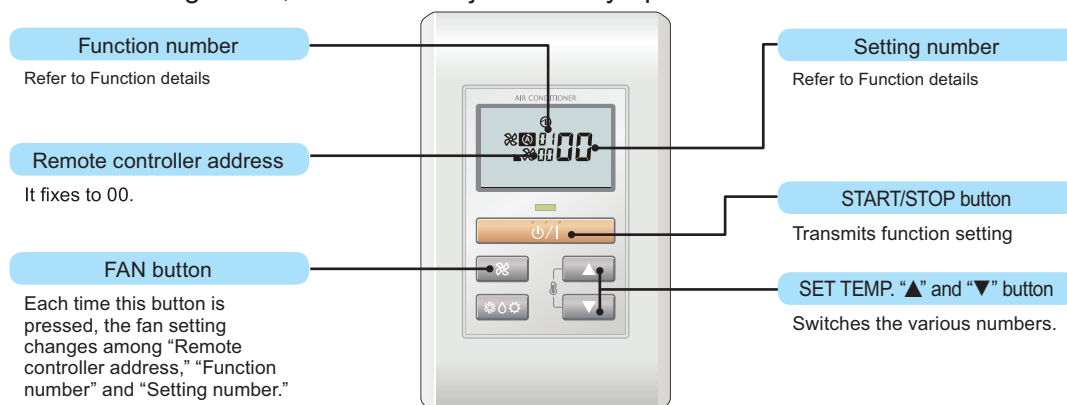

● Function setting procedure

1. Connect the power supply of the outdoor unit.
2. Switch to the function setting mode.

To enter the function setting mode, hold down the 3 buttons of SET TEMP. ▲, SET TEMP. ▼ and FAN at the same time for 5 seconds or longer.

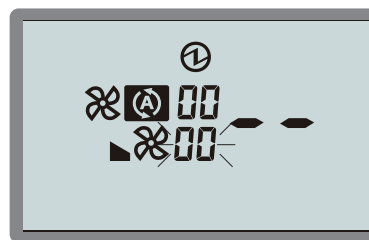
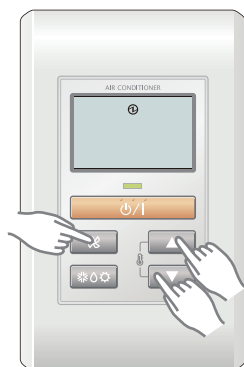

Function setting mode initial display

3. Press the FAN button.
The Function number indicator flashes. Then, press either the SET TEMP. ▲ button or the SET TEMP. ▼ button to set up the function number.

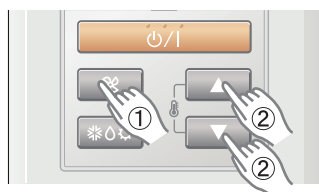

Function number

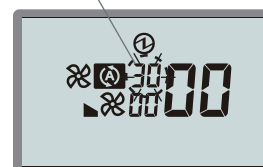

4. Select the setting number by pressing the SET TEMP. ▲ or SET TEMP. ▼ button. The setting number indicator flashes during setting number selection.

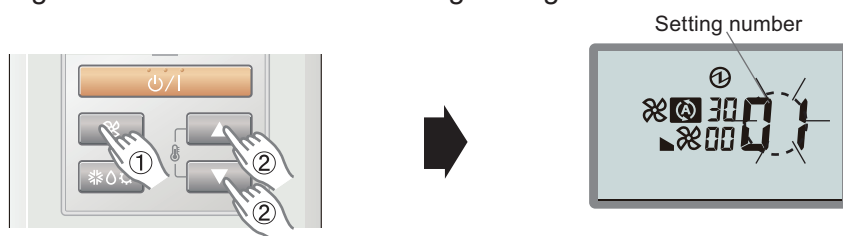

Example) Function number : 30, Setting number : 01

5. Confirm the setting by pressing the TIMER SET button. The data will be transferred to the indoor unit.

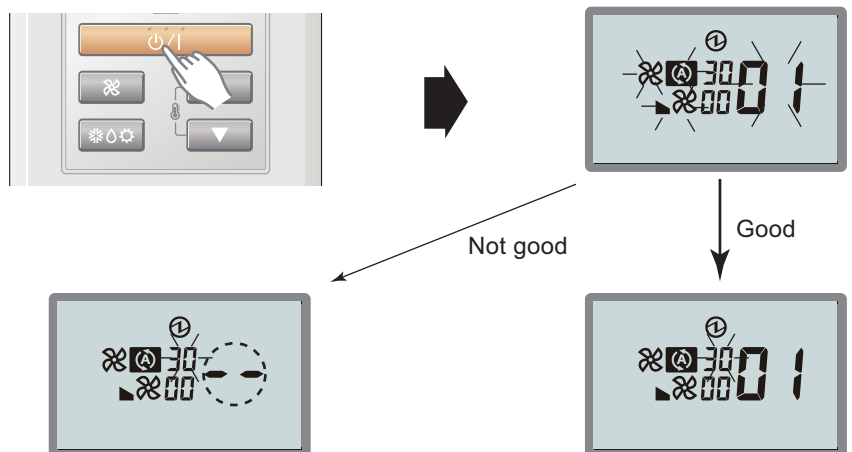

- Data is not set up on the indoor unit correctly (-- is displayed.)
- Set up the data again according to the procedure in step 3, 4 above.

Data is correctly set up on the indoor unit.

Function details: Refer to Chapter 14-5. "[Function details](#)" on page 268.

6. Exit the function setting mode by pressing the 3 buttons of SET TEMP. ▲, SET TEMP. ▼, and FAN at the same time for 5 seconds or longer. After exiting the function setting mode, the display returns to the normal mode.

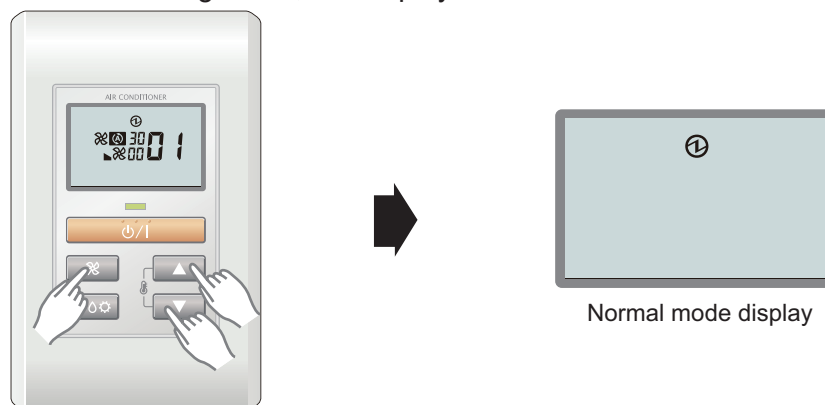

If no button is pressed within 60 seconds after buttons mentioned above are pressed, it will automatically exit the function setting mode.

If you exit the function setting mode unintentionally during setting, enter the mode again according to the procedure in step 2.

● Setting up each indoor unit

Repeat the procedures from step 1 to 6, and set up the indoor units requiring function setting.

● Resetting the power after setting up function of all indoor units

NOTES:

- If the reset is not performed, function cannot be read correctly.
- After all the functions have been set, the circuit breaker needs to be switched off for at least 2 minutes.
 - After the 2 minutes has passed, power can be restored.
 - The set function is stored in the PCB and will remain in memory even when the power of indoor unit is turned off.
However setting function is effective after disconnecting the power supply and then reconnecting it.
- Record the latest configuration of the indoor unit function setting on a label, and put the label on the unit so it can be used for after-sales service operations.

■ UTY-RSRY/UTY-RHRY

● Setting procedure by using wired remote controller

The function number and the associated setting value are displayed on the LCD of the remote controller. Follow the instructions written in the local setup procedure supplied with the remote controller, and select appropriate setting according to the installation environment.

Before connecting the power supply of the indoor unit, reconfirm following items:

- Piping air tight test and vacuuming have been performed firmly.
- There is no wiring mistake.

NOTE: Set only one Master remote controller.

1. Connect the power supply.
2. With “Monitor mode” screen displayed, press and hold the SET TEMP. \wedge button and FAN \vee button simultaneously for at least 2 seconds.

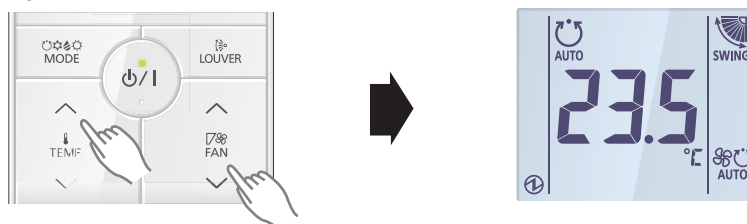

3. The Menu 1 screen is displayed. Press and hold the SET TEMP. \wedge button at least 2 seconds. Setting mode selection screen is displayed.

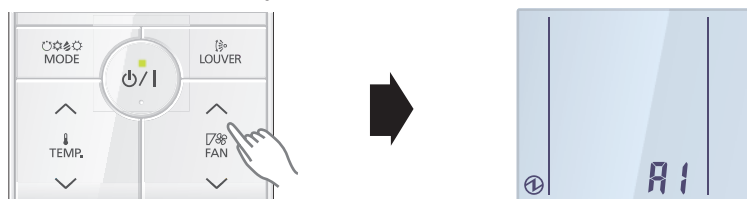

4. Press the SET TEMP. \wedge or SET TEMP. \vee button to select F1 (Menu 2-F1) setting mode or F2 (Menu 2-F2) setting mode.

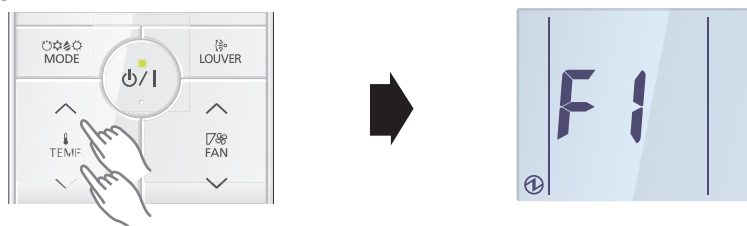

F1: Initial settings mode

F2: Maintenance settings mode

5. Press the ϕ/I button. Setting item selection screen is displayed. (Item No. is displayed.)

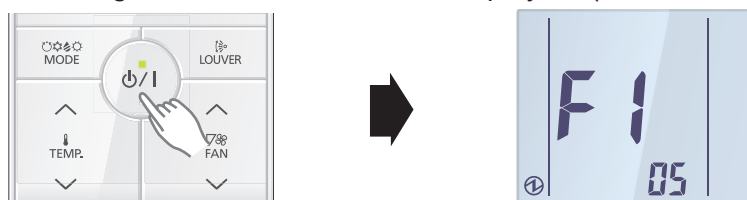

- Select the item number to be set with the SET TEMP. \wedge or SET TEMP. \vee button, and press the ϕ/I button to switch to the setting screen.

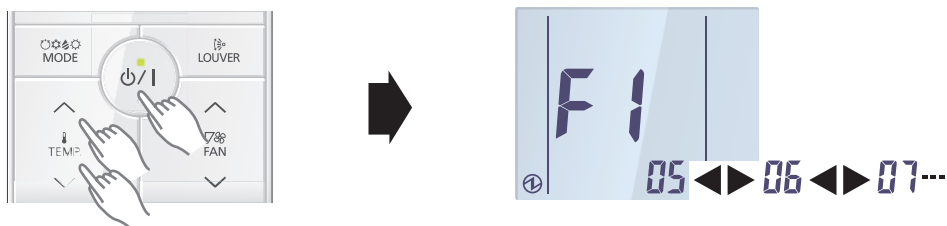

- Select the "13" in Menu 2-F1 settings. Then, press the ϕ/I button.



- Select the 2-wire remote controller address with the SET TEMP. \wedge or SET TEMP. \vee button. Then press the ϕ/I button.

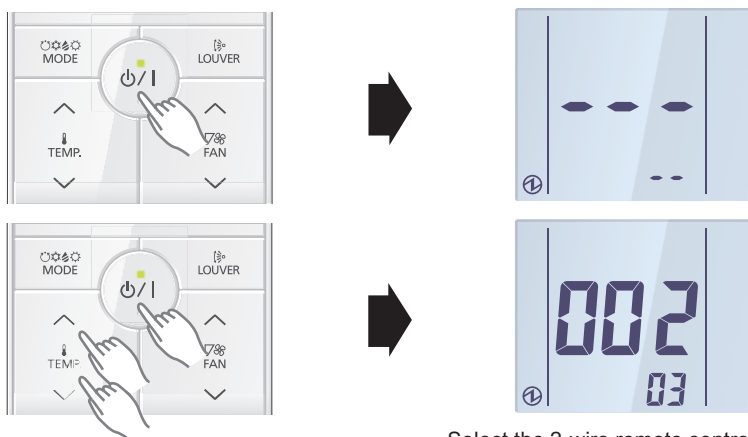

Select the 2-wire remote controller address (Ex. Select the 002-03)

- Set the function number with the SET TEMP. \wedge or SET TEMP. \vee button. Then press the ϕ/I button.

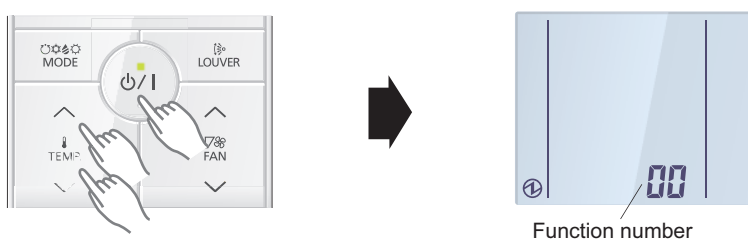

- Set the setting number with the SET TEMP. \wedge or SET TEMP. \vee button. Then press the ϕ/I button.

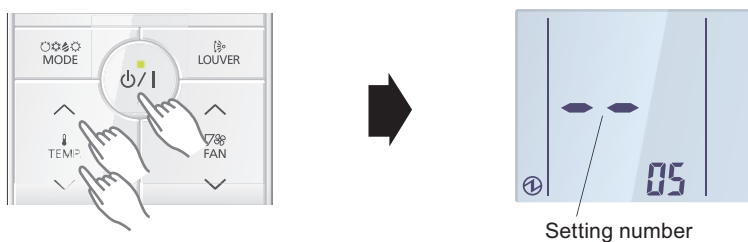

11. Setting results are displayed after data transmission.



12. Press the ϕ/I button to return to the 2-wire remote controller address selection screen of step 9. If setting has been completed, press the FAN ∇ button to return to the Menu 2-F1 item selection screen.

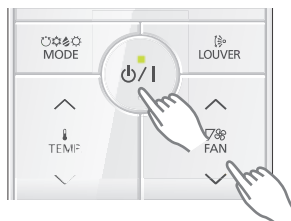

● Setting up each indoor unit

Repeat the procedure from step 1 to 6, and set up the indoor units requiring function setting.

● Resetting the power after setting up function of all indoor units

NOTES:

- If the reset is not performed, function cannot be read correctly.
- After all the functions have been set, the circuit breaker needs to be switched off for at least 2 minutes.
 - After the 2 minutes has passed, power can be restored.
 - The set function is stored in the PCB and will remain in memory even when the power of indoor unit is turned off.
However setting function is effective after disconnecting the power supply and then reconnecting it.
- Record the latest configuration of the indoor unit function setting on a label, and put the label on the unit so it can be used for after-sales service operations.

14-5. Function details

■ Contents of function setting

Each function setting listed in this section is adjustable in accordance with the installation environment.

NOTE: Setting will not be changed if invalid numbers or setting values are selected.

● Function setting list

	Function no.	Functions	Compact cassette	Mini duct	Slim duct	Medium static pressure duct	Wall mounted			Ceiling	Floor
							KG	KM	KE		
1)	00	Remote controller address setting	—	—	—	—	●	●	●	—	—
2)	11	Filter sign	●	●	●	●	●	●	●	●	●
3)	20	Ceiling height	●	—	—	—	—	—	—	●	—
4)	21	Static pressure	—	—	—	●	—	—	—	—	—
5)	22	Outlet directions	●	—	—	—	—	—	—	—	—
6)	26	Static pressure	—	●	●	—	—	—	—	—	—
7)	28	Horizontal louver direction switching for dew condensation prevention	—	—	—	—	—	—	●	—	—
8)	30/31	Room temperature control for indoor unit sensor	●	●	●	●	●	●	●	●	●
9)	35/36	Room temperature control for wired remote controller sensor	●	●	●	●	●	●	●	●	—
10)	40	Auto restart	●	●	●	●	●	●	●	●	●
11)	42	Room temperature sensor switching	●	●	●	●	●	●	●	●	●
12)	44	Remote controller custom code	●	●	●	●	●	●	●	●	●
13)	46	External input control	●	●	●	●	●	●	●	●	●
14)	48	Room temperature sensor switching (Aux.)	●	●	●	●	●	●	●	●	—
15)	49	Indoor unit fan control for energy saving for cooling	●	●	●	●	●	●	●	●	—
16)	60	Switching functions for external output terminal	●	●	●	●	●	—	—	●	●

1) Remote controller address setting (for Wall-mounted type only)

NOTES:

- Because this setting is normally done automatically when 2-wire-type wired remote controller is installed, setting is unnecessary.
- This setting is configurable only by wireless remote controller, but not configurable by Polar 3-wired remote controller.

Multiple indoor units can be operated by using one wired remote controller.

Set the unit number of each indoor unit.

Function number	Setting value	Setting description	Factory setting
00	00	Unit no. 0	◆
	01	Unit no. 1	
	02	Unit no. 2	
	03	Unit no. 3	
	04	Unit no. 4	
	05	Unit no. 5	
	06	Unit no. 6	
	07	Unit no. 7	
	08	Unit no. 8	
	09	Unit no. 9	
	10	Unit no. 10	
	11	Unit no. 11	
	12	Unit no. 12	
	13	Unit no. 13	
	14	Unit no. 14	
15	Unit no. 15		

NOTES:

- When connecting Polar 3-wired remote controller, set the remote controller address in the order of 0, 1, 2,, and 15.
- When different type of indoor units (such as wall mounted type and cassette type, cassette type and duct type, or other combinations) are connected using group control system, some functions may no longer be available.

2) Filter sign

Select appropriate intervals for displaying the filter sign on the indoor unit according to the estimated amount of dust in the air of the room.

If the indication is not required, select "No indication" (03).

Function number	Setting value	Setting description	Factory setting
11	00	Standard	
	01	Long interval	
	02	Short interval	
	03	No indication	◆

Setting description	Compact cassette	Mini duct	Slim duct	Medium static pressure duct	Wall mounted
Standard	2,500 hours	400 hours		2,500 hours	400 hours
Long interval	4,400 hours	1,000 hours		4,400 hours	1,000 hours
Short interval	1,250 hours	200 hours		1,250 hours	200 hours

3) Ceiling height (for Compact cassette type and Ceiling type only)

Select the appropriate ceiling height according to the place of installation.

Function number	Setting value	Setting description	Factory setting
20	00	Standard	◆
	01	High ceiling	

For the specific height for each setting value, refer to "Installation space" in Chapter 3. "[Dimensions](#)" on page 24.

In case of cassette type models:

The ceiling height values are for the 4-way outlet. Do not change this setting in the 3-way outlet mode.

7,000 or 9,000 Btu/h models cannot be installed in high ceilings. Do not change this setting.

4) Static pressure (for Medium static pressure duct type only)

Select the appropriate static pressure according to the installation conditions.

Function number	Setting value	Setting description	Factory setting
21	00	Normal	◆
	01	High static pressure 1	
	02	High static pressure 2	
	03	High static pressure 3	

5) Outlet directions (for Compact cassette type only)

Select the appropriate number of outlet directions according to the installation conditions.

Function number	Setting value	Setting description	Factory setting
22	00	4-way	◆
	01	3-way	

6) Static pressure (for Mini duct type and Slim duct type)

Select the appropriate static pressure according to the installation conditions.

For mini duct type:

Function number	Setting value	Setting description	Factory setting
26	00	0 Pa	
	01	10 Pa	
	02	20 Pa	
	03	30 Pa	
	04	40 Pa	
	05	50 Pa	
	31	Standard (10 Pa: 07; 09; 12 models, 15 Pa: 14; 18 models)	◆

NOTES:

- Range of static pressure is different by model.

Model	Range of static pressure
07, 09, 12 models	0 to 30 Pa
14, 18 models	0 to 50 Pa

- Setting number in 07, 09, 12 models is "04 to 30": Operation is same as that "03".
- Setting number in 14, 18 models is "06 to 30": Operation is same as that "05".
- Setting number value cannot be set to 32 or more.

For slim duct type:

Function number	Setting value	Setting description	Factory setting
26	00	0 Pa	
	01	10 Pa	
	02	20 Pa	
	03	30 Pa	
	04	40 Pa	
	05	50 Pa	
	06	60 Pa	
	07	70 Pa	
	08	80 Pa	
	09	90 Pa	
	31	Standard (25 Pa)	◆

7) Horizontal louver direction switching for dew condensation prevention (for KE model in Wall-mounted type only)

Automatically switches the position of the horizontal louver if the airflow direction is set at lower than the dew condensation limit position in cooling or drying operation.

Select suitable adjustment position according to the customer's preference.

Function number	Setting value	Setting description	Factory setting
28	00	Adjust to dew condensation limit position	◆
	01	Adjust to cooling standard position	

8) Room temperature control for indoor unit sensor

Depending on the installed environment, correction of the room temperature sensor may be required. Select the appropriate control setting according to the installed environment.

The temperature of the room temperature sensor is corrected as follows:

Corrected temp. = Temp. of the room temp. sensor - Correction temp. value

Example of correction:

When the temperature of the room temp. sensor is 26°C and the setting value is "03" (-1.0°C), corrected temp. will be 27°C (26°C - [-1.0°C]).

The temperature correction values show the difference from the Standard setting "00" (manufacturer's recommended value).

Function number		Setting value	Setting description	Factory setting	
30 (For cooling)	31 (For heating)	00	Standard setting	◆	
		01	No correction 0.0 °C		
		02	-0.5 °C	More cooling Less heating	
		03	-1.0 °C		
		04	-1.5 °C		
		05	-2.0 °C		
		06	-2.5 °C		
		07	-3.0 °C		
		08	-3.5 °C		
		09	-4.0 °C		
		10	+0.5 °C	Less cooling More heating	
		11	+1.0 °C		
		12	+1.5 °C		
		13	+2.0 °C		
		14	+2.5 °C		
		15	+3.0 °C		
		16	+3.5 °C		
17	+4.0 °C				

9) Room temperature control for wired remote controller sensor (for other than Floor type)

Depending on the installed environment, correction of the wire remote temperature sensor may be required. Select the appropriate control setting according to the installed environment.

To change this setting, set Function 42 to Both "01".

Ensure that the Thermo Sensor icon is displayed on the remote controller screen.

Function number		Setting value	Setting description	Factory setting	
35 (For cooling)	36 (For heating)	00	Standard setting	◆	
		01	No correction 0.0°C		
		02	-0.5 °C	More cooling Less heating	
		03	-1.0 °C		
		04	-1.5 °C		
		05	-2.0 °C		
		06	-2.5 °C		
		07	-3.0 °C		
		08	-3.5 °C		
		09	-4.0 °C		
		10	+0.5 °C	Less cooling More heating	
		11	+1.0 °C		
		12	+1.5 °C		
		13	+2.0 °C		
		14	+2.5 °C		
		15	+3.0 °C		
		16	+3.5 °C		
17	+4.0 °C				

10) Auto restart

Enables or disables automatic restart after a power interruption.

Function number	Setting value	Setting description	Factory setting
40	00	Enable	◆
	01	Disable	

NOTE: Auto restart is an emergency function such as for power outage etc. Do not attempt to use this function in normal operation. Be sure to operate the unit by remote controller or external device.

11) Room temperature sensor switching

When using the wired remote controller temperature sensor, change the setting to "Both" (01).

Function number	Setting value	Setting description	Factory setting
42	00	Indoor unit	◆
	01	Both	

00: Sensor on the indoor unit is active.

01: Sensors on both indoor unit and wired remote controller are active.

NOTE: Remote controller sensor must be turned on by using the remote controller.

12) Remote controller custom code

(Only for wireless remote controller)

The indoor unit custom code can be changed. Select the appropriate custom code.

Function number	Setting value	Setting description	Factory setting
44	00	A	◆
	01	B	
	02	C	
	03	D	

13) External input control

"Operation/Stop" mode or "Forced stop" mode can be selected.

Function number	Setting value	Setting description	Factory setting
46	00	Operation/Stop mode 1	◆
	01	(Setting prohibited)	
	02	Forced stop mode	
	03	Operation/Stop mode 2	

14) Room temperature sensor switching (Aux.) (for other than Floor type)

To use the temperature sensor on the wired remote controller only, change the setting to "Wired remote controller" (01).

This function will only work if the function setting 42 is set at "Both" (01).

When the setting value is set to "Both" (00), more suitable control of the room temperature is possible by setting function setting 30 and 31 too.

Function number	Setting value	Setting description	Factory setting
48	00	Both	◆
	01	Wired remote controller	

15) Indoor unit fan control for energy saving for cooling (for other than Floor type)

Enables or disables the power-saving function by controlling the indoor unit fan rotation when the outdoor unit is stopped during cooling operation.

Function number	Setting value	Setting description	Factory setting
49	00	Disable	
	01	Enable	
	02	Remote controller	◆

00: When the outdoor unit is stopped, the indoor unit fan operates continuously following the setting on the remote controller.

01: When the outdoor unit is stopped, the indoor unit fan operates intermittently at a very low speed.

02: Enable or disable this function by remote controller setting.

NOTES:

- As the factory setting, this setting is initially activated.
- Set to "00" or "01" when connecting a remote controller that cannot set the Fan control for energy saving function or connecting a network converter.
To confirm if the remote controller has this setting, refer to the operating manual of each remote controller.

16) Switching functions for external output terminal (For other than KM and KE models in Wall-mounted type)

Functions of the external output terminal can be switched. For details, refer to “External input and output”.

Function number	Setting value	Setting description	Factory setting
60	00	Operation status	◆
	01—08	(Setting prohibited)	
	09	Error status	
	10	Indoor unit fan operation status	
	11	External heater	

14-6. Wired remote controller (UTY-RNNYM)

DIP switch 1	SW1	Prohibited
	SW2	Dual remote controller setting
	SW3	Prohibited
	SW4	°F/°C switch
	SW5	Prohibited
	SW6	Memory backup setting

* Do not use DIP switch 2.

Switch location

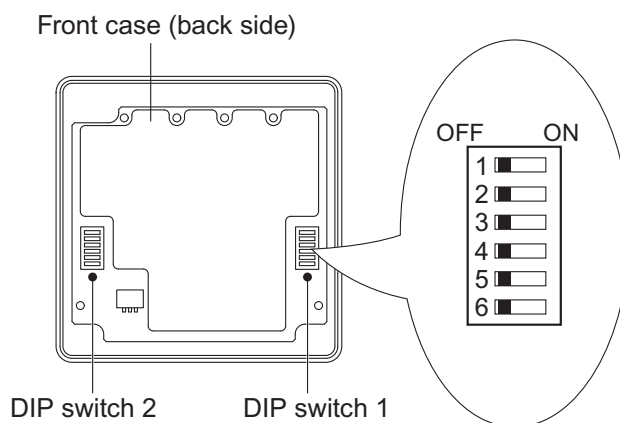

DIP switch 1 setting

SW2: Dual remote controller setting

Set the remote controller SW2 according to the following table.

Number of remote controller	Primary unit	Secondary unit	Factory setting
	SW2	SW2	
1 (Normal)	OFF	—	◆
2 (Dual)	OFF	ON	

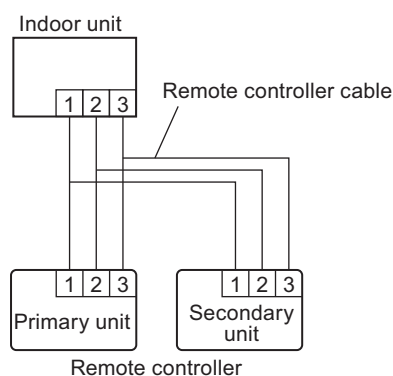

SW4: Switching temperature unit °F / °C

Displayed temperature unit can be switched between Fahrenheit (°F) and Celsius (°C).

SW4	Fahrenheit (°F) / Celsius (°C)	Factory setting
OFF	°C	◆
ON	°F	

● SW6: Memory backup setting

Set to "ON" to use batteries for the memory backup.

When batteries are not used, all of settings stored in memory will be deleted if there is a power failure.

SW6	Memory backup	Factory setting
OFF	Disable	◆
ON	Enable	

14-7. Wired remote controller (UTY-RVNYM)

DIP switch 1	SW1	Memory backup setting
	SW2	Dual remote controller setting

■ Switch location

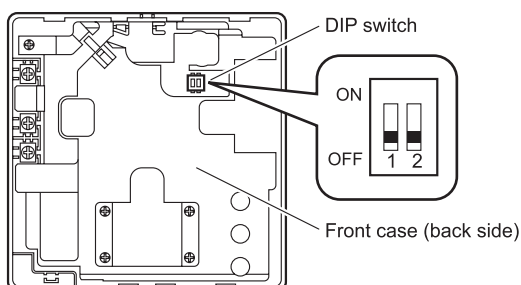

■ DIP switch setting

● SW1: Memory backup setting

Set to "ON" to use batteries for the memory backup.

When batteries are not used, all of settings stored in memory will be deleted if there is a power failure.

SW1	Memory backup	Factory setting
OFF	Disable	◆
ON	Enable	

● SW2: Dual remote controller setting

Set the remote controller SW2 according to the following table.

Number of remote controller	Primary unit	Secondary unit	Factory setting
	SW2	SW2	
1 (Normal)	OFF	—	◆
2 (Dual)	OFF	ON	

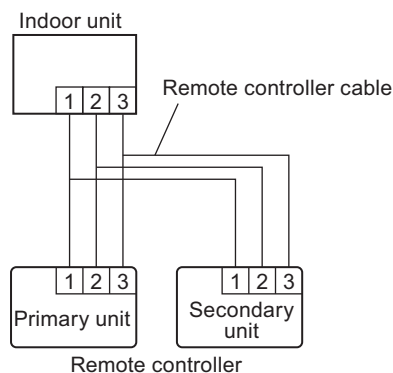

14-8. Wired remote controller (UTY-RLRY)

DIP switch	Memory backup setting
------------	-----------------------

■ Switch location

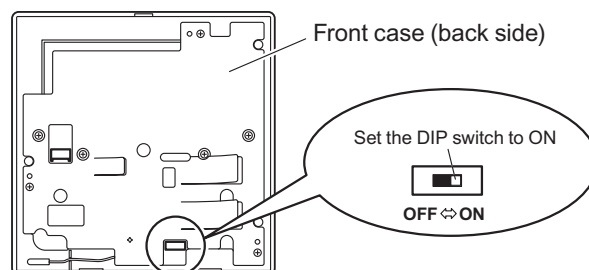

■ Dip switch setting

● SW1: Memory backup setting

Set to "ON" to use batteries for the memory backup.

When batteries are not used, all of settings stored in memory will be deleted if there is a power failure.

SW1	Memory backup	Factory setting
OFF	Disable	◆
ON	Enable	

14-9. Wired remote controller (UTY-RNRYZ*)

DIP switch	Memory backup setting
------------	-----------------------

■ Switch location

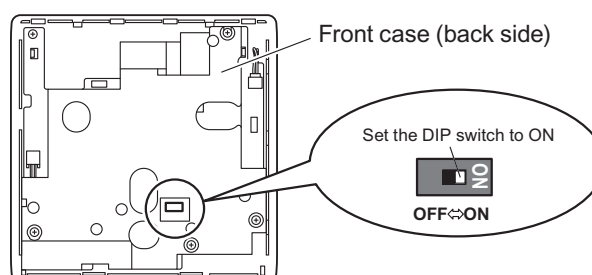

■ Dip switch setting

● SW1: Memory backup setting

Set to "ON" to use batteries for the memory backup.

When batteries are not used, all of settings stored in memory will be deleted if there is a power failure.

SW1	Memory backup	Factory setting
OFF	Disable	◆
ON	Enable	

14-10. Simple remote controller (UTY-RSNYM)

DIP switch	SW1	Prohibited
	SW2	Dual remote controller setting
	SW3	°F/°C switch
	SW4	Prohibited
	SW5	Prohibited
	SW6	Prohibited

Switch location

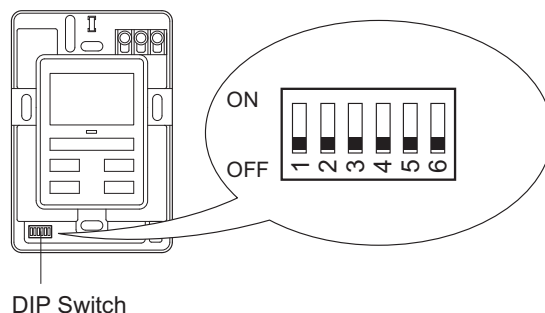

DIP switch setting

● SW2: Dual remote controller setting

Set the remote controller SW2 according to the following table.

Number of remote controller	Primary unit	Secondary unit	Factory setting
	SW2	SW2	
1 (Normal)	OFF	—	◆
2 (Dual)	OFF	ON	

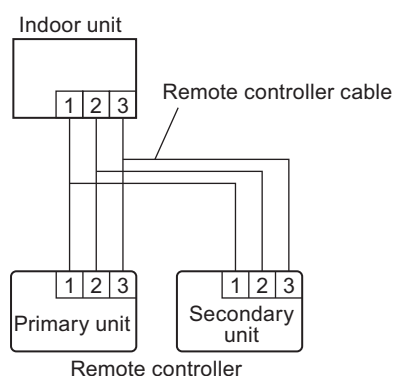

● SW3: Switching temperature unit °F / °C







Displayed temperature unit can be switched between Fahrenheit (°F) and Celsius (°C).

SW3	Fahrenheit (°F) / Celsius (°C)	Factory setting
OFF	°C	◆
ON	°F	

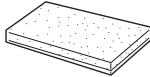
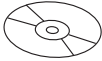
15. Accessories

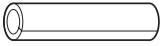
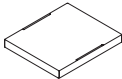
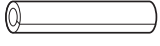



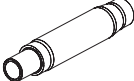

15-1. Compact cassette type

■ Models: AUXG07KVLA, AUXG09KVLA, AUXG12KVLA, AUXG14KVLA, AUXG18KVLA, and AUXG22KVLA

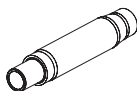
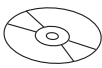





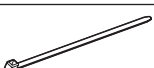
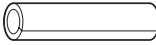
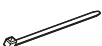
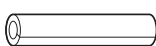
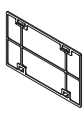
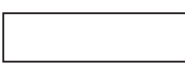

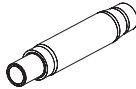
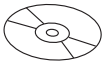

Part name	Exterior	Q'ty	Part name	Exterior	Q'ty
Operating manual		1	Drain hose insulation		1
Operating manual (CD-ROM)		1	Hose band		1
Installation manual		1	Coupler heat insulation (large)		1
Template (Carton top)		1	Coupler heat insulation (small)		1
M10 nut A (with flange)		4	Cable tie		2
M10 nut B (with spring lock washer)		4	Wire crammer		1
Drain hose		1			

15-2. Mini duct type

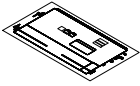
■ Models: ARXG07KSLAP, ARXG09KSLAP, ARXG12KSLAP, and ARXG14KSLAP

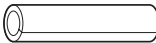

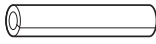

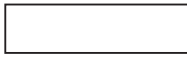







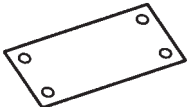
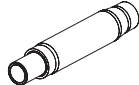

Part name	Exterior	Q'ty	Part name	Exterior	Q'ty
Operating manual		1	Drain hose		1
Operating manual (CD-ROM)		1	Hose band		1
Installation manual		1	Drain hose insulation B		1
Installation template (Carton top)		1	Washer		8
Cable tie (large)		4	Coupler heat insulation (large)		1
Cable tie (medium)		3	Coupler heat insulation (small)		1
Filter (small)		2	Insulation (For electrical wiring)		2

■ Model: ARXG18KSLAP

Part name	Exterior	Q'ty	Part name	Exterior	Q'ty
Operating manual		1	Drain hose		1
Operating manual (CD-ROM)		1	Hose band		1
Installation manual		1	Drain hose insulation B		1
Installation template (Carton top)		1	Washer		8
Cable tie (large)		4	Coupler heat insulation (large)		1
Cable tie (medium)		3	Coupler heat insulation (small)		1
Filter (large)		2	Insulation (For electrical wiring)		2

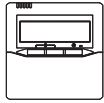
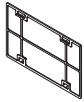







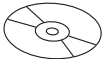

15-3. Slim duct type

■ Models: ARXG07KLLAP, ARXG09KLLAP, ARXG12KLLAP, ARXG14KLLAP, and ARXG18KLLAP

Part name	Exterior	Q'ty	Part name	Exterior	Q'ty
Operating manual		1	Cable tie (Large)		4
Installation manual		1	Cable tie (Small)		3
Installation template		1	Drain hose		1
Washer		8	Hose band		1
Coupler heat insulation (Large)		1	Drain hose insulation B		1
Coupler heat insulation (Small)		1	Remote controller		1
Filter (Small) (For 9/12 models)		2	Remote controller cable		1
Filter (Large) (For 18 models)		2	Tapping screw		2

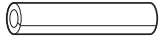
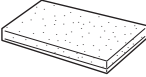





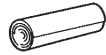
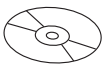

15-4. Medium static pressure duct type

■ Model: ARXG22KMLB



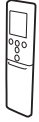
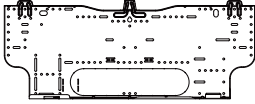

Part name	Exterior	Q'ty	Part name	Exterior	Q'ty
Operating manual		1	Cable tie (medium)		1
Operating manual (CD-ROM)		1	Cable tie (small)		1
Installation manual		1	Coupler heat insulation (large)		1
Hanger		4	Coupler heat insulation (small)		1
Drain hose insulation		1	M10 nut A (with flange)		4
Cable tie (large)		1	M10 nut B (with spring lock washer)		4

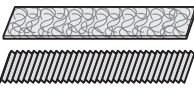
15-5. Wall mounted type



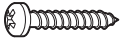

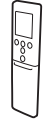
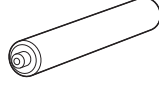

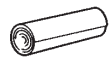
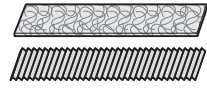
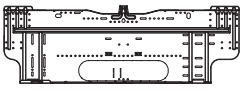

■ Models: ASYG07-14KGTB, ASYG07-14KMTB, and ASYG07-14KMCC

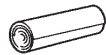
Part name	Exterior	Q'ty	Part name	Exterior	Q'ty
Operating manual		1	Cloth tape		1
Operating manual (CD-ROM)		1	Tapping screw (large)		5
Installation manual		1	Tapping screw (small)		2
Remote controller		1	Wall hook bracket		1
Battery		2	Filter holder		2
Remote controller holder		1	Air cleaning filters		1

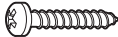
■ Models: ASYG18KMTB, ASYG22KMTB, and ASYG24KMTB

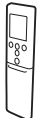
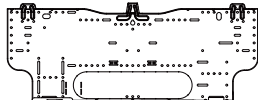



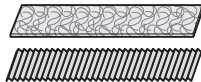
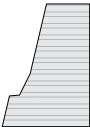





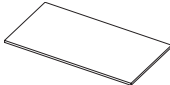

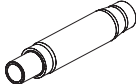

Part name	Exterior	Q'ty	Part name	Exterior	Q'ty
Operating manual		1	Tapping screw (large)		5
Installation manual		1	Tapping screw (small)		2
Remote controller		1	Battery		2
Remote controller holder		1	Filter holder		2
Cloth tape		1	Air cleaning filters		1
Wall hook bracket		1			

■ Models: ASYG07KETA, ASYG09KETA, ASYG12KETA, ASYG14KETA, ASYG07KETA-B, ASYG09KETA-B, ASYG12KETA-B, and ASYG14KETA-B

Part name	Exterior	Q'ty	Part name	Exterior	Q'ty
Operating manual		1	Cloth tape		1
Operating manual (CD-ROM)		1	Tapping screw (large)		5
Installation manual		1	Tapping screw (small)		2
Remote controller		1	Wall hook bracket		1
Battery		2	Filter holder		2
Remote controller holder		1	Air cleaning filters		1
Template (for pipe cover cutting)		1			



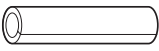

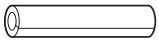

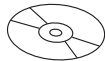

15-6. Ceiling type

■ Models: ABYG18KRTA and ABYG22KRTA

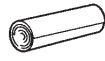
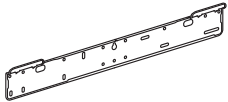
Part name	Exterior	Q'ty	Part name	Exterior	Q'ty
Operating manual		1	Insulation		1
Operating manual (CD-ROM)		1	Drain hose		1
Installation manual		1	Hose band		1
Template		1	Cable tie (large)		4
M10 nut A (with flange)		4	Cable tie (small)		1
M10 nut B (with spring lock washer)		4	Remote controller cable hole cap		1
Washer		8	Tapping screw (White)		6
Coupler heat insulation (large)		1	Tapping screw		3
Coupler heat insulation (small)		1			

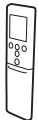
15-7. Floor type

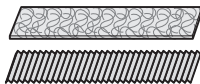
■ Models: AGYG09KVCA, AGYG12KVCA, and AGYG14KVCA

Part name	Exterior	Q'ty	Part name	Exterior	Q'ty
Operating manual		1	Operating manual (CD-ROM)		1
Installation manual		1	Cloth tape		1
Wall hook bracket		1	Tapping screws (large)		9
Remote controller		1	Tapping screws (small)		2
Battery		2	Air cleaning filters		1
Remote controller holder		1			

16. Optional parts

16-1. Controllers

■ Lineup

Indoor unit type		Type					
		Wireless remote controller					
		AR-REM4E	AR-REM7E	AR-REB1E	AR-REW2E	AR-REW4E	UTY-LNTY
Compact cassette		—	—	—	—	—	○
Mini duct		—	—	—	—	—	—
Slim duct		—	—	—	—	—	—
Medium static pressure duct		—	—	—	—	—	—
Wall mounted	KG		●	—	—	—	—
	KMTB	18-24 model	—	—	—	●	—
		07-14 model	—	—	●	—	—
	KMCC		—	—	●	—	—
	KE		—	—	—	—	●
Ceiling		—	—	—	—	—	—
Floor		—	●	—	—	—	—

Indoor unit type		Type				
		Wired remote controller				
		UTY-RNNYM	UTY-RVNYM	UTY-RLRY	UTY-RNRYZ*	
Compact cassette		○	○	○	○	
Mini duct		○	○	○	○	
Slim duct		○	○	○	○	
Medium static pressure duct		○	○	○	○	
Wall mounted	KG		—	—	○*2	○*2
	KMTB	18-24 model	—	—	○*2	○*2
		07-14 model	○*1	○*1	—	—
	KMCC		○*1	○*1	—	—
	KE		—	—	○*2	○*2
Ceiling		—	—	○	○	
Floor		—	—	○*3	○*3	





Indoor unit type		Type					
		IR receiver kit with Wireless remote controller		Simple remote controller			
		UTY- LBTYM	UTY-LBTYH	UTY-RSNYM	UTY-RSRY	UTY-RHRY	
Compact cassette		—	—	○	○	○	
Mini duct		○	—	○	○	○	
Slim duct		○	—	○	○	○	
Medium static pressure duct		○	—	○	○	○	
Wall mounted	KG		—	—	—	○*2	○*2
	KMTB	18-24 model	—	—	—	○*2	○*2
		07-14 model	—	—	○*1	—	—
	KMCC		—	—	○*1	—	—
	KE		—	—	—	○*2	○*2
Ceiling		—	○	—	○	○	
Floor		—	—	—	○*3	○*3	

●: Accessory, ○: Optional, —: Not applicable

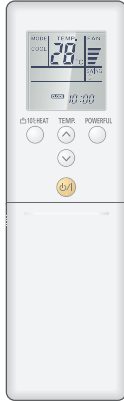

- *1: Optional Communication kit (UTY-TWBXF2) is necessary for the installation.
- *2: Optional Communication kit (UTY-TWRXZ2) is necessary for the installation.
- *3: Optional Communication kit (UTY-TWRXZ3) is necessary for the installation.

Parts

Wireless remote controller





			
AR-REW4E	AR-REM4E	AR-REB1E	UTY-LNTY

Wireless remote controller

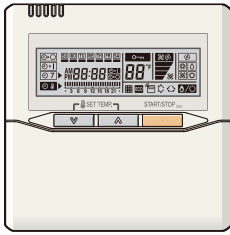
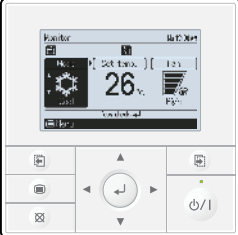
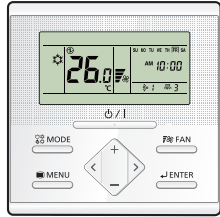
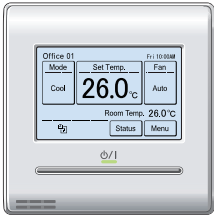
	
AR-REW2E	AR-REM7E

Wired remote controller

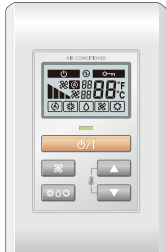
			
UTY-RNNYM	UTY-RVNYM	UTY-RLRY	UTY-RNRYZ*

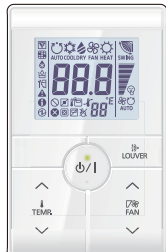
IR receiver kit with Wireless remote controller		Simple remote controller		
				
UTY-LBTYM	UTY-LBTYH	UTY-RSNYM	UTY-RSRY	UTY-RHRY

16-2. Cassette grille

■ Lineup

Indoor unit type	Model
Compact cassette	UTG-UFYF-W

■ Part

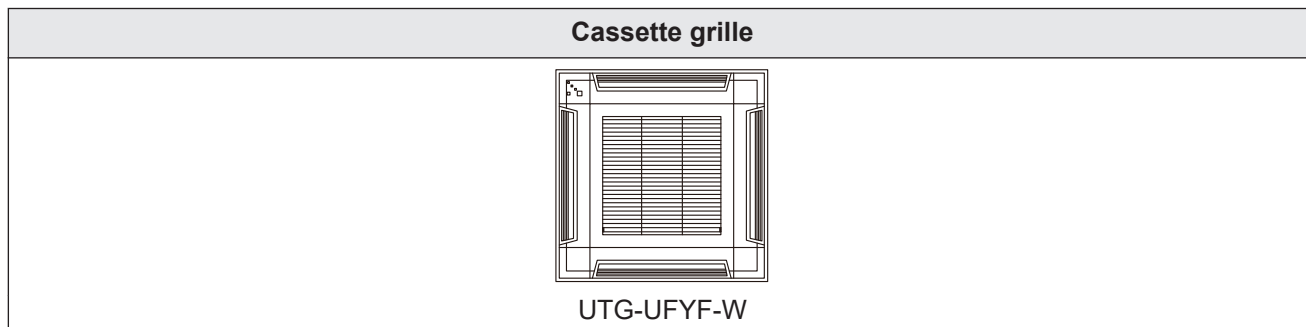

16-3. Others

Lineup

Indoor unit type		Type					
		Air outlet shutter plate	Insulation kit for high humidity	Fresh air intake kit	Half concealed kit	External input and output PCB	
		UTR-YDZB	UTZ-KXGC	UTZ-VXAA	UTR-STA	UTY-XCSXZ2	UTY-XCSX
Compact cassette		○	○	○	—	—	○
Mini duct		—	—	—	—	—	—
Slim duct		—	—	—	—	—	—
Medium static pressure duct		—	—	—	—	—	—
Wall mounted	KG	—	—	—	—	○	—
	KMTB	18-24 model	—	—	—	○	—
		07-14 model	—	—	—	—	—
	KMCC		—	—	—	—	—
	KE		—	—	—	—	○
Ceiling		—	—	—	—	—	○
Floor		—	—	—	○	—	—

Indoor unit type		Type					
		External switch controller	Auto louver grille kit	External connect kit			
		UTY-TERX	UTD-GXTA-W UTD-GXTB-W	UTY-XWZX	UTY-XWZXZ5	UTY-XWZXZG	
Compact cassette		○	—	—	—	○	
Mini duct		○	○	—	—	○	
Slim duct		○	○	—	—	○	
Medium static pressure duct		○	—	—	—	○	
Wall mounted	KG	○*2	—	○	—	—	
	KMTB	18-24 model	○*2	—	○	—	
		07-14 model	○*1	—	—	○	—
	KMCC		○*1	—	—	○	—
	KE		○*2	—	—	○	—
Ceiling		○	—	—	—	○	
Floor		○*3	—	—	○	—	

Indoor unit type		Type					
		KNX converter	Network converter		MODBUS converter	Remote sensor unit	
		UTY-VKSX	UTY-VTGX	UTY-VTGXV	UTY-VMSX	UTY-XSZX	
Compact cassette		○	○	○	○	—	
Mini duct		○	○	○	○	○	
Slim duct		○	○	○	○	○	
Medium static pressure duct		○	○	○	○	○	
Wall mounted	KG	○	○*2	○*2	○	—	
	KMTB	18-24 model	○	○*2	○*2	○	—
		07-14 model	○	○*1	○*1	○	—
	KMCC	○	○*1	○*1	○	—	
	KE	○	○*2	○*2	○	—	
Ceiling		○	○	○	○	—	
Floor		○	○*3	○*3	○	—	

Indoor unit type		Type						
		Communication kit			Wireless LAN adapter*4			
		UTY-TWBXF2	UTY-TWRXZ2	UTY-TWRXZ3	UTY-TFSXW1	UTY-TFSXF2	UTY-TFSXZ1	
Compact cassette		—	—	—	—	—	○	
Mini duct		—	—	—	—	—	○	
Slim duct		—	—	—	—	—	○	
Medium static pressure duct		—	—	—	—	—	○	
Wall mounted	KG	—	○	—	○	—	—	
	KMTB	18-24 model	—	○	—	—	○	—
		07-14 model	○	—	—	○	—	—
	KMCC	○	—	—	○	—	—	
	KE	—	○	—	—	○	—	
Ceiling		—	—	—	—	—	○	
Floor		—	—	○	—	—	○	







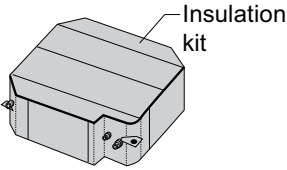
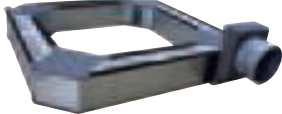
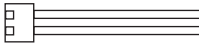

Indoor unit type		Type			
		Square flange	Round flange	Long-life filter	Drain pump unit
		UTD-SF045T	UTD-RF204	UTD-LF25NA	UTZ-PX1NBA
Compact cassette		—	—	—	—
Mini duct		—	—	—	—
Slim duct		—	—	—	—
Medium static pressure duct		○	○	○	○
Wall mounted	KG	—	—	—	—
	KMTB	18-24 model	—	—	—
		07-14 model	—	—	—
	KMCC	—	—	—	—
	KE	—	—	—	—
Ceiling		—	—	—	—
Floor		—	—	—	—

●:Accessory, ○: Optional, —: Not applicable

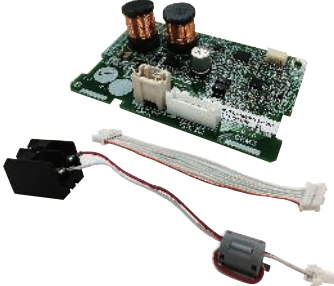

- *1: Optional Communication kit (UTY-TWBXF2) is necessary for the installation.
- *2: Optional Communication kit (UTY-TWRXZ2) is necessary for the installation.
- *3: Optional Communication kit (UTY-TWRXZ3) is necessary for the installation.
- *4: For details of WLAN control, refer to “Design & Technical manual” or “Setting manual” of WLAN control system.

NOTE: Combined use of MODBUS converter, KNX converter, and Wireless LAN adapter is not allowed.

Parts

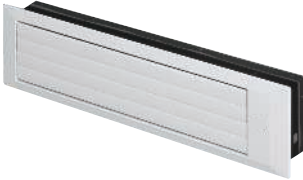

<p>Air outlet shutter plate Model: UTR-YDZB</p> 	<p>Insulation kit for high humidity Model: UTZ-KXGC</p> 
<p>Fresh air intake kit Model: UTZ-VXAA</p> 	<p>External connect kit Model: UTY-XWZXZG</p> 
<p>External connect kit Model: UTY-XWZX</p> 	<p>External connect kit Model: UTY-XWZXZ5</p> 
<p>External input and output PCB Model: UTY-XCSXZ2</p> 	<p>Communication kit Model: UTY-TWRXZ2</p> 
<p>Communication kit Model: UTY-TWBXF2</p> 	<p>MODBUS converter Model: UTY-VMSX</p> 
<p>KNX converter Model: UTY-VKSX</p> 	<p>External switch controller Models: UTY-TERX</p> 

Remote sensor unit Model: UTY-XSZX	Auto louver grille kit Models: UTD-GXTA-W
	

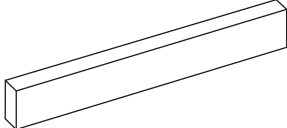
Wireless LAN adapter Models: UTY-TFSXZ1	Wireless LAN adapter Models: UTY-TFSXW1
	

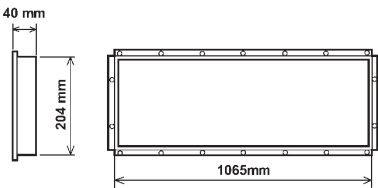
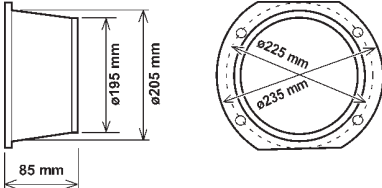
Wireless LAN adapter Models: UTY-TFSXF2	Half concealed kit Models: UTR-STA
	

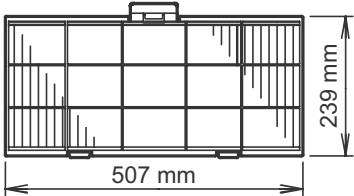
Square flange Models: UTD-SF045T	Round flange Models: UTD-RF204
	

Long-life filter Models: UTD-LF25NA	Drain pump unit Models: UTZ-PX1NBA
	

17. Indoor unit installation precautions

NOTE: The information listed below are general precautions.
Some models also include items that do not apply.

17-1. Places where prohibited for use

- Places where there is a danger of combustible gas leakage.
- Places where sulfur gas, chlorine gas, acid, alkali, or other matter which effects equipment is generated.
- Places where there is a lot of oil splash and steam such as kitchen or machinery room.
- Places where machinery which generates high frequencies is used.
- Ocean beaches and other areas where there is a lot of salt.
- Places where carbon fibers or any kind of powder suspended in the air.
- Inside of vehicles, ships, and other conveyances.
- Places where voltage fluctuations are large such as a factory.

17-2. Points to remember when installing

- The product shall be installed at a place which can withstand the weight and vibration of the indoor.
- To allow maintenance after refrigerant piping, drain piping, and electric wiring connection and installation, provide an installation service space and an inspection port, as required.
*Installation service space is shown on "[Dimensions](#)" on page 24.
- Be careful when installing the unit at the following places.

Condition	Contents	Countermeasures (Reference)
When the ceiling is high.	If the indoor unit is installed where the installation height given in the installation manual is exceeded, the temperature difference between the floor and ceiling of the room will be large and the heating effect will be poor. Moreover, even if the indoor unit is installed within the installation height, a similar phenomena will occur when installed in a room in which the doors are opened and closed frequently and hot air circulation is obstructed by furniture such as desks or chairs.	<ol style="list-style-type: none"> 1. Switch the setting to the high ceiling mode. 2. Install a circulator. 3. Arrange the furniture in the room so that it does not obstruct the hot air.
When lower level directly contacts the outside air.	When the lower level of the room is a semi-open space such as warehouse or parking lot the surface temperature of the flooring will become low and the radiation of cold from the floor will increase. In this case, even if the room temperature is suitable, you may feel the foot level is cold.	
When the airflow distribution is poor.	When an indoor unit is installed in a position where the outlet airflow will directly contact people, a draft may be felt. In addition, when there are obstructions in the path of the intake and outlet airflow, the air distribution may become extremely bad.	<ol style="list-style-type: none"> 1. Adjust the louver fins or take other measures matched to the site. 2. Change the indoor unit outlet.

Condition	Contents	Countermeasures (Reference)
When inside the ceiling is high temperature and high humidity.	When the indoor unit is installed where the inside of the ceiling is 30 °C RH80% or greater, the dew point temperature of the outer perimeter may become higher than the cabinet surface temperature and moisture will condense on the surface of the cabinet and water drops may fall inside the room. ("Figure 17-1 Moist air curve") In addition, the humidity may vary considerably the same as when the inside of the ceiling is close to hermetically sealed and used as the outside air intake path.	<ol style="list-style-type: none"> 1. Add heat insulating material to the outside of the indoor unit cabinet. *Regarding the cassette type, use of optional High humidity correspondence kit is recommended. 2. Strengthen the heat insulating material of the refrigerant piping and drain piping too. ("Figure 17-2 Work method when reinforcing the heat insulation of on-site piping") 3. When the humidity inside the ceiling changes considerably, install a ventilation port.
When using an external duct.	When using an external duct to take in new fresh air, etc., condensation may form on the surface of the duct due to the effect of the outside air temperature and the humidity inside the ceiling.	Always perform heat insulation processing. (Heat insulating material: Glass wool 25 mm thick or more.)
When the remote controller installation site is bad.	If the cold or warm air blown out from the air conditioner directly contacts the thermostat section of the remote controller, the outlet temperature of the air conditioner may be sensed and room temperature control will be different from the room temperature, and "not cooled" or "not heated" or other trouble may occur. In addition, there is the possibility that the same kind of trouble may also occur when the remote controller is effected by direct sunlight.	<ol style="list-style-type: none"> 1. Install the remote controller where it will not be directly exposed to the cold or hot air. 2. Install the remote controller where it will not be directly exposed to sunlight or strong lighting.
When installation environment is quiet.	When the wall mounted type was installed in a bedroom, living room, or other quiet place, the sound of the refrigerant flow may be sensed as noise and must be taken into account.	<ol style="list-style-type: none"> 1. Plan installation of a model with external expansion valve. 2. Plan installation of a branch box farther from indoor unit. 3. Plan installation using another air conditioner.
When installing duct type in ceiling chamber system.	In the case of the ceiling chamber system (duct is not installed at indoor unit inlet side and room air is sucked into the indoor unit through the inside of the ceiling), the thermistor inside the indoor unit may not correctly detect the room temperature. <ul style="list-style-type: none"> • Heating operation: Room is not heated because the indoor unit is easily turned off by the thermostat. • Cooling operation: Room is too cold because the indoor unit is difficult to turn off by the thermostat. 	Replace the indoor unit thermistor with optional Remote sensor unit, and install the sensor where the room temperature can be correctly detected.
When the outlet air is sucked in at duct type.	Cooling operation does not cool the room and heating operation does not heat the room because the short circuited indoor unit is not turned on by the thermostat.	<ol style="list-style-type: none"> 1. Reconsider the ventilation port construction. 2. Replace the indoor unit thermistor with optional Remote sensor unit, and install the sensor where the room temperature can be correctly detected.
When using the wireless remote controller.	Signals may not be received when using it in a room illuminated by an inverter fluorescent lamp.	Turn on the fluorescent lamp and check if the indoor unit receives the signals from the remote controller. If the indoor unit does not receive the signals, consult an authorized service personnel.
When installing the inverter type.	It may generate noise in TV sets, stereos and PCs.	The inverter type should be installed at a sufficient distance from these equipments.

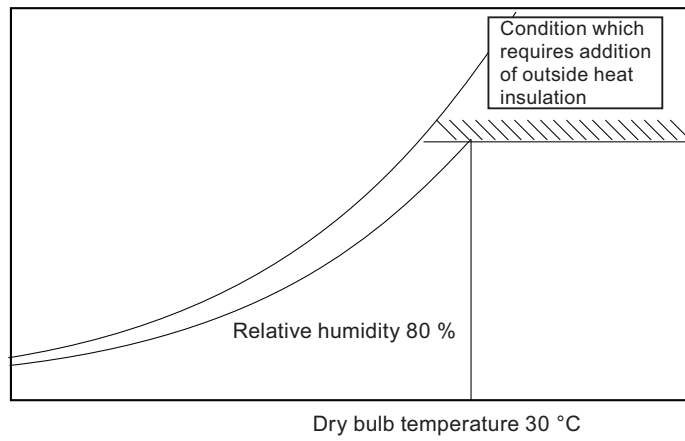

Figure 17-1 **Moist air curve**

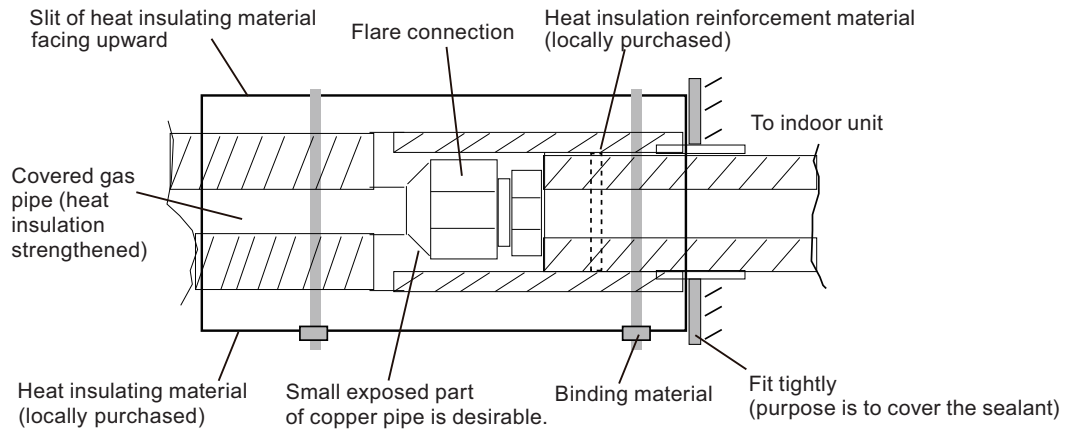

Figure 17-2 **Work method when reinforcing the heat insulation of on-site piping**

Part 2. OUTDOOR UNIT (4 UNITS TYPE)

**MULTI-SPLIT TYPE:
AOYG30KBTA4**

1. Specifications

Type			Inverter heat pump	
Model name			AOYG30KBTA4	
Power source			230 V 50 Hz	
Available voltage range			198—264V	
Standard combination of indoor unit			Wall mounted ASYG07KMCC ×4	
Capacity	Cooling	Rated	kW	8.0
			Btu/h	27,300
		Min.—Max.	kW	2.4—10.1
	Heating		Btu/h	8,200—34,500
		Rated	kW	9.6
			Btu/h	32,800
		Min.—Max.	kW	3.0—11.2
			Btu/h	10,200—38,100
Input power	Cooling	Rated	kW	2.05
		Max.		3.25
	Heating	Rated		2.11
		Max.		2.95
Current	Cooling	Rated	A	9.1
	Heating	Rated		9.4
EER	Cooling		kW/kW	3.9
COP	Heating			4.55
Starting current			A	9.4
Maximum operating current *1			A	18.5
Fan	Type × Qty		Propeller × 1	
	Airflow rate	Cooling	m ³ /h	2,400
		Heating		2,950
	Motor output		W	49
Sound pressure level *2	Cooling		dB (A)	50
	Heating			54
Heat exchanger	Dimension (H × W × D)		mm	Main1: 840 × 881 × 18.19 Main2: 840 × 851 × 18.19
	Fin pitch			1.3
	Rows × Stages		Main1: 1 × 40 Main2: 1 × 40	
	Pipe type (Material)		Copper tube	
	Fin type (Material)		Aluminum	
Compressor	Type × Quantity		DC twin rotary × 1	
	Motor output		W	1,450
Refrigerant	Type		R32 (675)	
	Charge		g	2,200
Refrigerant oil	Type		RmM68AF	
	Amount		cm ³	800
Enclosure	Material		Steel sheet	
	Color		Beige (Approximate color of Munsell 10YR 7.5/1.0 NN)	
Dimensions (H × W × D)	Net		mm	884 × 820 × 315
	Gross			1,058 × 1,027 × 445
Weight	Net		kg	55
	Gross			64
Connection pipe	Size	Liquid	mm (in)	∅6.35 (∅1/4) × 4
		Gas		∅9.52 (∅3/8) × 2 + ∅12.7 (∅1/2) × 2
	Method		Flare	
	Pre-charge length (Total)		40	
	Maximum length (Total)		70	
	Maximum length (Each)		25	
	Minimum length (Total)		15	
	Minimum length (Each)		2.5	
	Maximum height difference between outdoor unit and each indoor units.		15	
	Maximum height difference between indoor units.		10	
Drain hose	Material		PP	
	Tip diameter		mm	∅13.0 (I.D.), ∅16.0 to ∅16.8 (O.D.)
Operation range	Cooling		°C	-10 to 46
	Heating			-15 to 24

NOTES:

- Specifications are based on the following conditions:
 - Power source of specifications: 230 V
 - Pipe length: 5 m, Height difference: 0 m [Outdoor unit—Indoor unit]
 - Cooling: Indoor temperature of 27.0 °CDB/19.0 °CWB, and outdoor temperature of 35 °CDB/24.0 °CWB.
 - Heating: Indoor temperature of 20.0 °CDB/15.0 °CWB, and outdoor temperature of 7.0 °CDB/6.0 °CWB.
- *1: Maximum operating current is the total current of the indoor unit and the outdoor unit.
- *2: Sound pressure level
 - Measured values in manufacturer's anechoic chamber.
 - Because of the surrounding sound environment, the sound levels measured in actual installation conditions might be higher than the specified values here.
- For other combination, refer to the combination table.
- The protective function might work when using it outside the operation range.
- This data is based on EN 14511 standard.

Specifications for ErP Lot10			
Model name		AOYG30KBT4	
Energy efficiency class	Cooling	A+++	
	Heating (Average)	A++	
Pdesign	Cooling	kW	8.0 (35 °C)
	Heating (Average)		6.5 (-10 °C)
SEER	Cooling	kWh/kWh	8.50
SCOP	Heating (Average)		4.60
Annual energy consumption	QCE	kWh/a	329
	QHE (Average)		1,978
Sound power level	Cooling	HIGH	dB (A)
	Heating		

2. Dimensions

2-1. Model: AOYG30KBTA4

Unit: mm

OUTDOOR UNIT
AOYG30KBTA4

OUTDOOR UNIT
AOYG30KBTA4

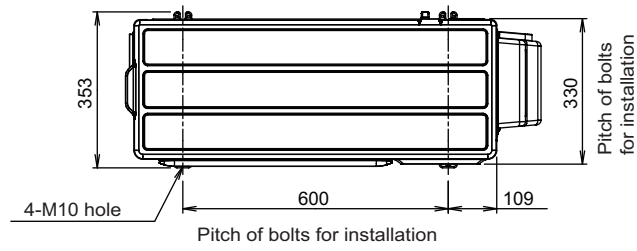

Top view

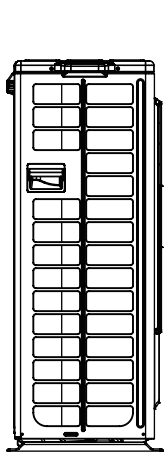

Side view

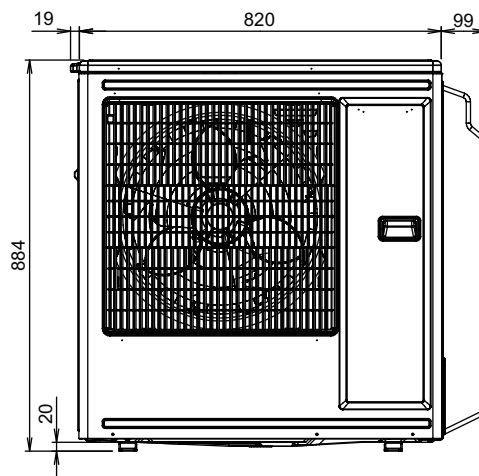

Front view

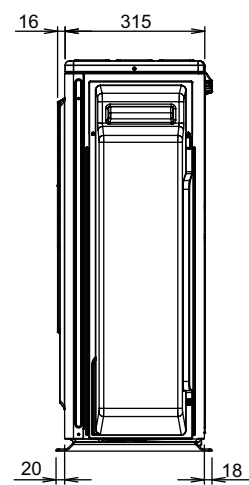

Side view

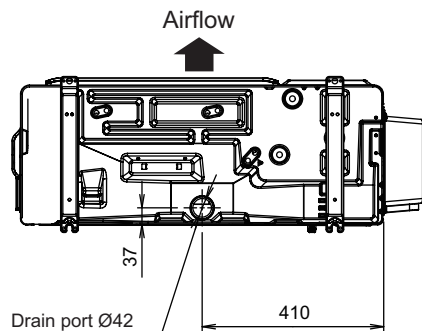

Bottom view

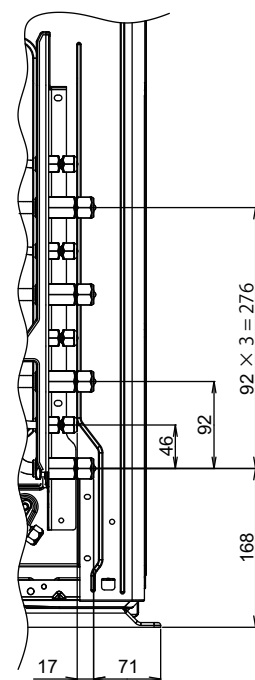

Side view (Valve part)

3. Installation space

3-1. Model: AOYG30KBTA4

■ Space requirement

Provide sufficient installation space for product safety.

⚠ CAUTION

Keep the space shown in the installation examples.

If the installation is not performed accordingly, it could cause a short circuit and result in a lack of operating performance.

● Single outdoor unit installation

- When the upper space is open:

Unit: mm

Obstacles at rear only

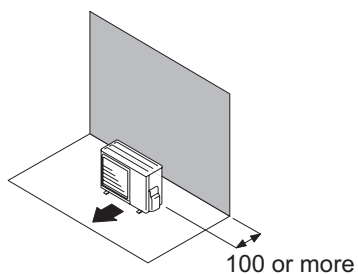

Obstacles at rear and sides

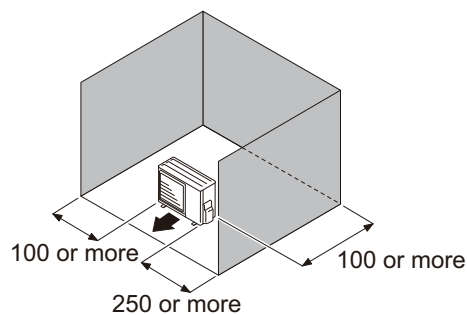

Obstacles at front

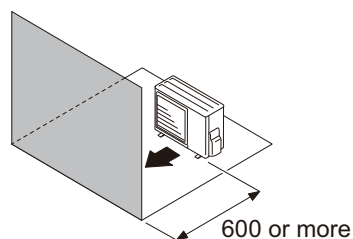

Obstacles at front and rear

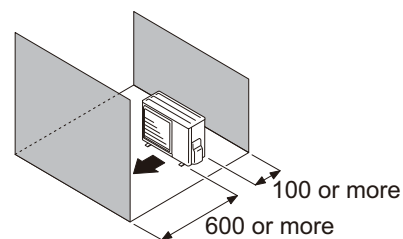

- When an obstruction in the upper space:

Unit: mm

Obstacles at rear and above

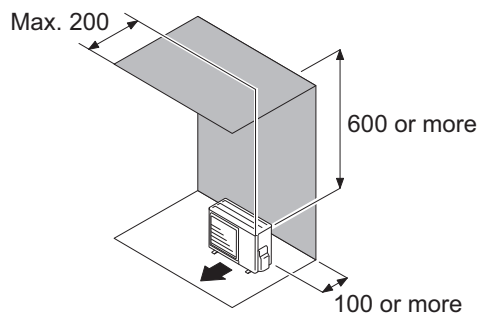

Obstacles at rear, sides, and above

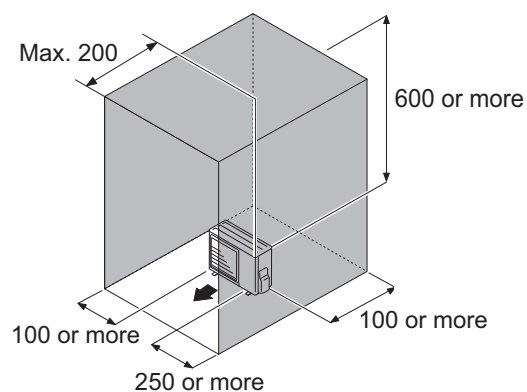

● Multiple outdoor unit installation

- Provide at least 250 mm of space between the outdoor units if multiple units are installed.
- When routing the piping from the side of an outdoor unit, provide space for piping.
- No more than 3 units must be installed side by side.
When 4 units or more are arranged in a line, provide the space as shown in the following example **“When an obstruction in the upper space:”**.
- **When the upper space is open:**

Unit: mm

Obstacles at rear only

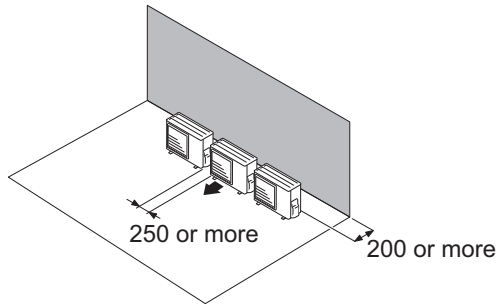

Obstacles at front only

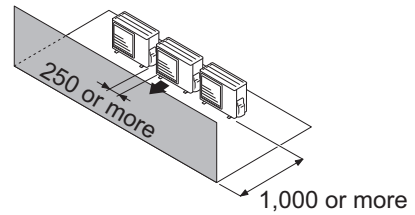

Obstacles at front and rear

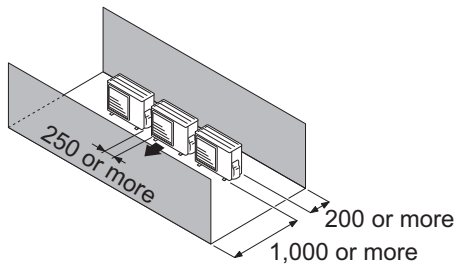

- **When an obstruction in the upper space:**

Unit: mm

Obstacles at rear and above.

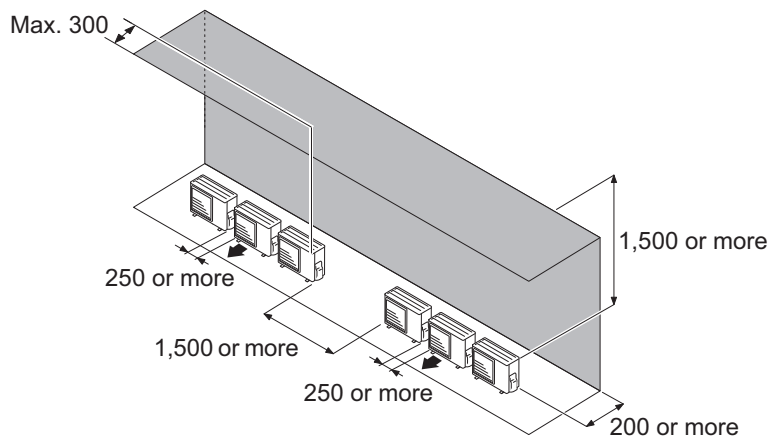

● Outdoor units installation in multi-row

Unit: mm

Single parallel unit arrangement

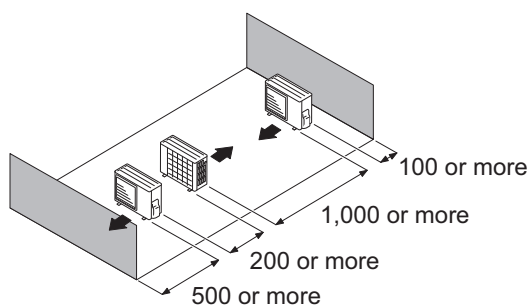

Multiple parallel unit arrangement

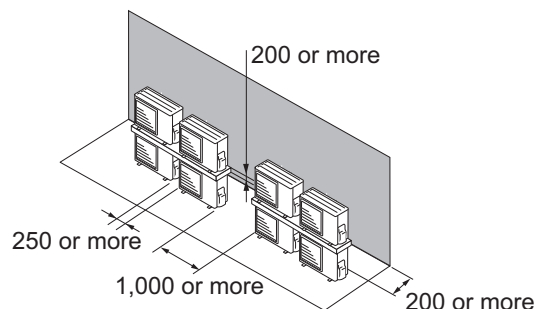
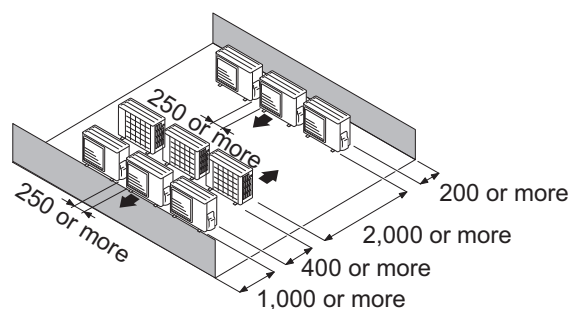

NOTES:

- If the space is larger than stated above, the condition will be the same as when there is no obstacle.
- When installing the outdoor unit, be sure to open the front and left side to obtain better operation efficiency.

⚠ CAUTION

- Do not install the outdoor unit in two-stage where the drain water could freeze. Otherwise the drainage from the upper unit may form ice and cause a malfunction of the lower unit.
- When the outdoor temperature is 0 °C or less, do not use the accessory drain pipe and drain cap. If the drain pipe and drain cap are used, the drain water in the pipe may freeze in extremely cold climate. (For reverse cycle model only.)
- In area with heavy snowfall, if the inlet and outlet of the outdoor unit is blocked with snow, it might become difficult to get warm, and it is likely to cause product malfunction. Construct a canopy and a pedestal, or place the unit on a high stand that is locally installed.

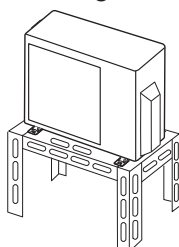

4. Refrigerant circuit

4-1. Model: AOYG30KBTA4

OUTDOOR UNIT
AOYG30KBTA4

OUTDOOR UNIT
AOYG30KBTA4

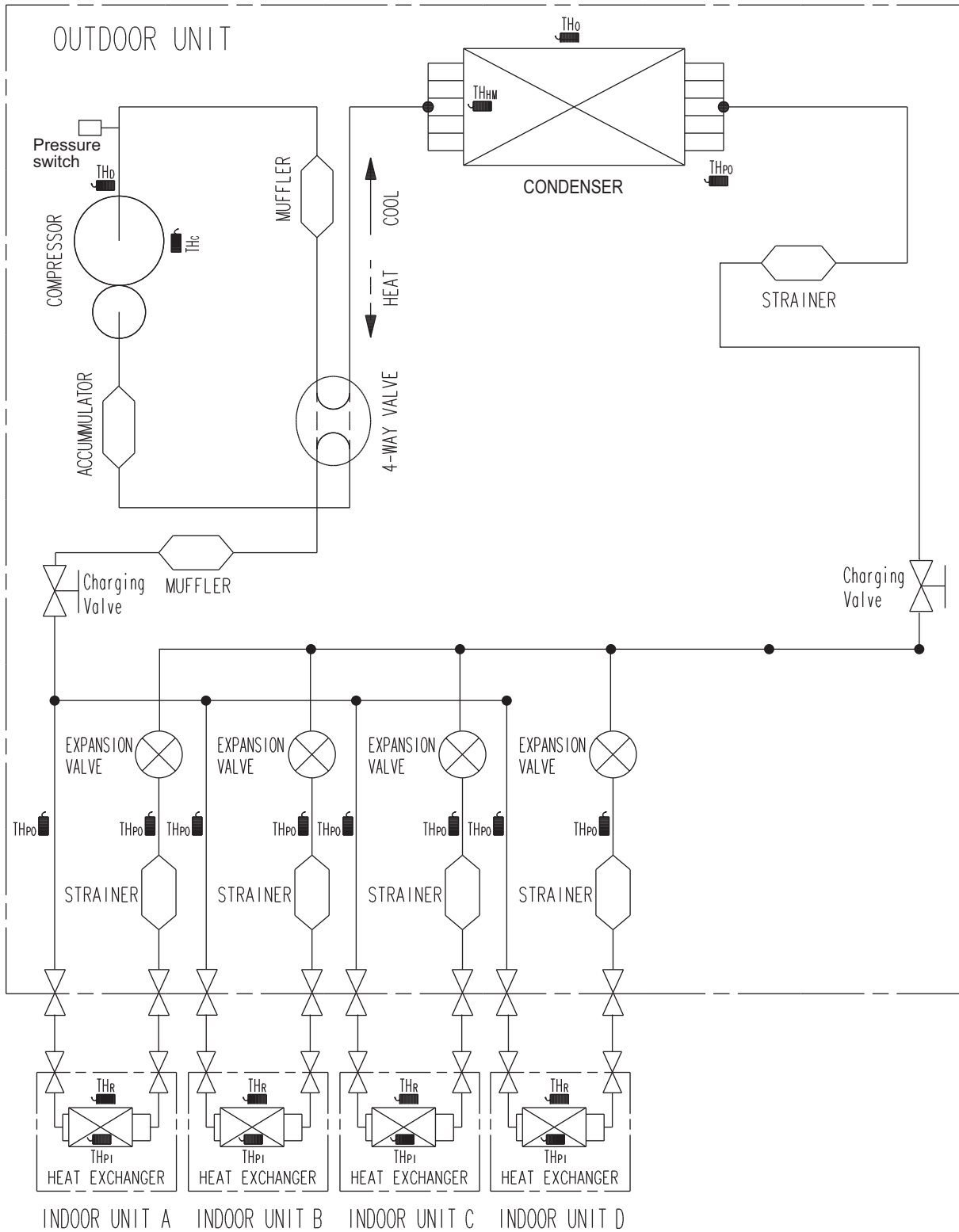

TH_o : THERMISTOR(DISCHARGE TEMP.)
 TH_o : THERMISTOR(OUTDOOR TEMP.)
 TH_{p_o} : THERMISTOR(PIPE TEMP.)
 TH_c : THERMISTOR(COMPRESSOR TEMP.)

TH_r : THERMISTOR(ROOM TEMP.)
 TH_{p_1} : THERMISTOR(PIPE TEMP.)
 TH_{H_M} : THERMISTOR(HEAT EXCHANGER MIDDLE TEMP.)

5. Wiring diagram

5-1. Model: AOYG30KBTA4

OUTDOOR UNIT
AOYG30KBTA4

OUTDOOR UNIT
AOYG30KBTA4

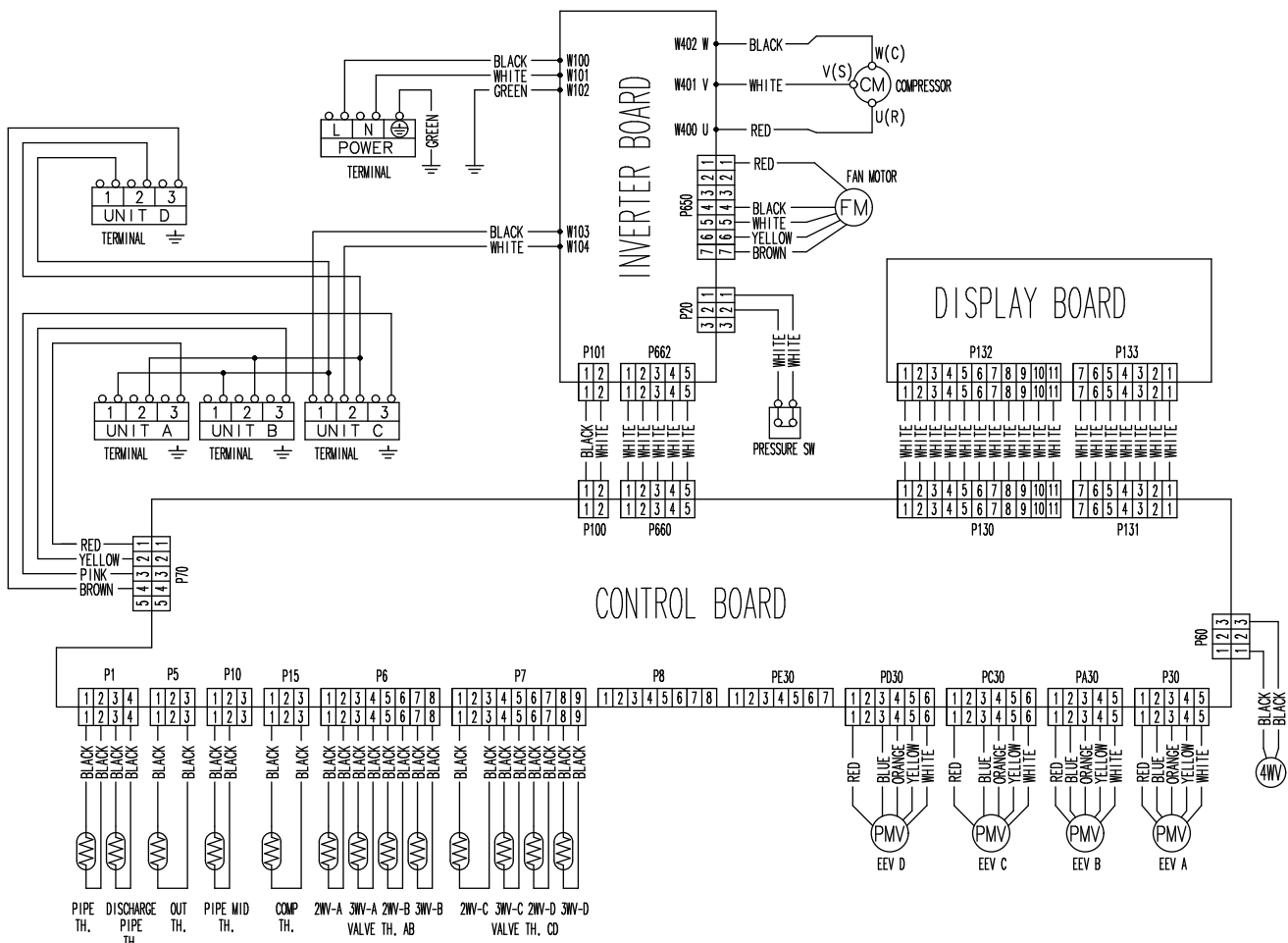

6. Capacity table

6-1. Combinations

Model: AOYG30KBTA4

● Cooling

OUTDOOR UNIT
AOYG30KBTA4

OUTDOOR UNIT
AOYG30KBTA4

Combination of indoor unit					Rated capacity for each indoor unit (kW)				Total capacity (kW)			Input power (kW)			EER (W/W)	Seasonal data		
Room				Total	Room				Min.	Rated	Max.	Min.	Rated	Max.		Pdesign (kW)	SEER (kWh/kWh)	Energy efficiency class
11	2	3	4		2	3	4											
7	22	—	—	29	2.00	6.00	—	—	2.4	8.00	10.1	0.45	2.67	3.25	3.00	8.0	7.5	A++
7	24	—	—	31	1.81	6.19	—	—	2.4	8.00	10.1	0.45	2.67	3.25	3.00	8.0	7.5	A++
9	22	—	—	31	2.32	5.68	—	—	2.4	8.00	10.1	0.45	2.67	3.25	3.00	8.0	7.5	A++
9	24	—	—	33	2.18	5.82	—	—	2.4	8.00	10.1	0.45	2.67	3.25	3.00	8.0	7.5	A++
12	18	—	—	30	3.20	4.80	—	—	2.4	8.00	10.1	0.45	2.67	3.25	3.00	8.0	7.5	A++
12	22	—	—	34	2.82	5.18	—	—	2.4	8.00	10.1	0.45	2.67	3.25	3.00	8.0	7.5	A++
12	24	—	—	36	2.67	5.33	—	—	2.4	8.00	10.1	0.45	2.67	3.25	3.00	8.0	7.5	A++
14	18	—	—	32	3.50	4.50	—	—	2.4	8.00	10.1	0.45	2.67	3.25	3.00	8.0	7.5	A++
14	22	—	—	36	3.11	4.89	—	—	2.4	8.00	10.1	0.45	2.67	3.25	3.00	8.0	7.5	A++
14	24	—	—	38	2.95	5.05	—	—	2.4	8.00	10.1	0.45	2.67	3.25	3.00	8.0	7.5	A++
18	18	—	—	36	4.00	4.00	—	—	2.4	8.00	10.1	0.45	2.67	3.25	3.00	8.0	7.5	A++
18	22	—	—	40	3.60	4.40	—	—	2.4	8.00	10.1	0.45	2.67	3.25	3.00	8.0	7.5	A++
18	24	—	—	42	3.43	4.57	—	—	2.4	8.00	10.1	0.45	2.67	3.25	3.00	8.0	7.5	A++
22	22	—	—	44	4.00	4.00	—	—	2.4	8.00	10.1	0.45	2.67	3.25	3.00	8.0	7.5	A++
22	24	—	—	46	3.83	4.17	—	—	2.4	8.00	10.1	0.45	2.67	3.25	3.00	8.0	7.5	A++
24	24	—	—	48	4.00	4.00	—	—	2.4	8.00	10.1	0.45	2.67	3.25	3.00	8.0	7.5	A++
7	7	12	—	26	2.00	2.00	3.50	—	2.4	7.50	9.3	0.45	2.10	2.84	3.57	7.5	8.1	A++
7	7	14	—	28	2.00	2.00	4.00	—	2.4	8.00	10.1	0.45	2.32	3.25	3.45	8.0	8.0	A++
7	7	18	—	32	1.75	1.75	4.50	—	2.4	8.00	10.1	0.45	2.32	3.25	3.45	8.0	8.0	A++
7	7	22	—	36	1.56	1.56	4.88	—	2.4	8.00	10.1	0.45	2.32	3.25	3.45	8.0	8.0	A++
7	7	24	—	38	1.47	1.47	5.06	—	2.4	8.00	10.1	0.45	2.32	3.25	3.45	8.0	8.0	A++
7	9	9	—	25	2.00	2.50	2.50	—	2.4	7.00	8.9	0.45	1.90	2.65	3.69	7.0	8.2	A++
7	9	12	—	28	2.00	2.50	3.50	—	2.4	8.00	10.1	0.45	2.32	3.25	3.45	8.0	8.0	A++
7	9	14	—	30	1.87	2.40	3.73	—	2.4	8.00	10.1	0.45	2.32	3.25	3.45	8.0	8.0	A++
7	9	18	—	34	1.64	2.12	4.24	—	2.4	8.00	10.1	0.45	2.32	3.25	3.45	8.0	8.0	A++
7	9	22	—	38	1.47	1.89	4.64	—	2.4	8.00	10.1	0.45	2.32	3.25	3.45	8.0	8.0	A++
7	9	24	—	40	1.40	1.80	4.80	—	2.4	8.00	10.1	0.45	2.32	3.25	3.45	8.0	8.0	A++
7	12	12	—	31	1.80	3.10	3.10	—	2.4	8.00	10.1	0.45	2.32	3.25	3.45	8.0	8.0	A++
7	12	14	—	33	1.70	2.91	3.39	—	2.4	8.00	10.1	0.45	2.32	3.25	3.45	8.0	8.0	A++
7	12	18	—	37	1.51	2.59	3.90	—	2.4	8.00	10.1	0.45	2.32	3.25	3.45	8.0	8.0	A++
7	12	22	—	41	1.37	2.34	4.29	—	2.4	8.00	10.1	0.45	2.32	3.25	3.45	8.0	8.0	A++
7	12	24	—	43	1.30	2.23	4.47	—	2.4	8.00	10.1	0.45	2.32	3.25	3.45	8.0	8.0	A++
7	14	14	—	35	1.60	3.20	3.20	—	2.4	8.00	10.1	0.45	2.32	3.25	3.45	8.0	8.0	A++
7	14	18	—	39	1.44	2.87	3.69	—	2.4	8.00	10.1	0.45	2.32	3.25	3.45	8.0	8.0	A++
7	14	22	—	43	1.30	2.60	4.10	—	2.4	8.00	10.1	0.45	2.32	3.25	3.45	8.0	8.0	A++
7	14	24	—	45	1.24	2.49	4.27	—	2.4	8.00	10.1	0.45	2.32	3.25	3.45	8.0	8.0	A++
7	18	18	—	43	1.30	3.35	3.35	—	2.4	8.00	10.1	0.45	2.32	3.25	3.45	8.0	8.0	A++
7	18	22	—	47	1.19	3.06	3.75	—	2.4	8.00	10.1	0.45	2.32	3.25	3.45	8.0	8.0	A++
7	18	24	—	49	1.14	2.94	3.92	—	2.4	8.00	10.1	0.45	2.32	3.25	3.45	8.0	8.0	A++
9	9	9	—	27	2.50	2.50	2.50	—	2.4	7.50	9.6	0.45	2.10	3.01	3.57	7.5	8.1	A++
9	9	12	—	30	2.40	2.40	3.20	—	2.4	8.00	10.1	0.45	2.32	3.25	3.45	8.0	8.0	A++
9	9	14	—	32	2.25	2.25	3.50	—	2.4	8.00	10.1	0.45	2.32	3.25	3.45	8.0	8.0	A++
9	9	18	—	36	2.00	2.00	4.00	—	2.4	8.00	10.1	0.45	2.32	3.25	3.45	8.0	8.0	A++
9	9	22	—	40	1.80	1.80	4.40	—	2.4	8.00	10.1	0.45	2.32	3.25	3.45	8.0	8.0	A++
9	9	24	—	42	1.71	1.71	4.58	—	2.4	8.00	10.1	0.45	2.32	3.25	3.45	8.0	8.0	A++
9	12	12	—	33	2.18	2.91	2.91	—	2.4	8.00	10.1	0.45	2.32	3.25	3.45	8.0	8.0	A++
9	12	14	—	35	2.06	2.74	3.20	—	2.4	8.00	10.1	0.45	2.32	3.25	3.45	8.0	8.0	A++
9	12	18	—	39	1.85	2.46	3.69	—	2.4	8.00	10.1	0.45	2.32	3.25	3.45	8.0	8.0	A++
9	12	22	—	43	1.67	2.23	4.10	—	2.4	8.00	10.1	0.45	2.32	3.25	3.45	8.0	8.0	A++
9	12	24	—	45	1.60	2.13	4.27	—	2.4	8.00	10.1	0.45	2.32	3.25	3.45	8.0	8.0	A++
9	14	14	—	37	1.94	3.03	3.03	—	2.4	8.00	10.1	0.45	2.32	3.25	3.45	8.0	8.0	A++
9	14	18	—	41	1.76	2.73	3.51	—	2.4	8.00	10.1	0.45	2.32	3.25	3.45	8.0	8.0	A++
9	14	22	—	45	1.60	2.49	3.91	—	2.4	8.00	10.1	0.45	2.32	3.25	3.45	8.0	8.0	A++
9	14	24	—	47	1.53	2.38	4.09	—	2.4	8.00	10.1	0.45	2.32	3.25	3.45	8.0	8.0	A++
12	12	12	—	36	2.67	2.67	2.67	—	2.4	8.00	10.1	0.45	2.32	3.25	3.45	8.0	8.0	A++
12	12	14	—	38	2.53	2.53	2.94	—	2.4	8.00	10.1	0.45	2.32	3.25	3.45	8.0	8.0	A++
12	12	18	—	42	2.29	2.29	3.42	—	2.4	8.00	10.1	0.45	2.32	3.25	3.45	8.0	8.0	A++
12	12	22	—	46	2.09	2.09	3.82	—	2.4	8.00	10.1	0.45	2.32	3.25	3.45	8.0	8.0	A++
12	12	24	—	48	2.00	2.00	4.00	—	2.4	8.00	10.1	0.45	2.32	3.25	3.45	8.0	8.0	A++
12	14	14	—	40	2.40	2.80	2.80	—	2.4	8.00	10.1	0.45	2.32	3.25	3.45	8.0	8.0	A++
12	14	18	—	44	2.18	2.55	3.27	—	2.4	8.00	10.1	0.45	2.32	3.25	3.45	8.0	8.0	A++
12	18	18	—	48	2.00	3.00	3.00	—	2.4	8.00	10.1	0.45	2.32	3.25	3.45	8.0	8.0	A++
14	14	14	—	42	2.67	2.67	2.67	—	2.4	8.00	10.1	0.45	2.32	3.25	3.45	8.0	8.0	A++
14	14	18	—	46	2.43	2.43	3.14	—	2.4	8.00	10.1	0.45	2.32	3.25	3.45	8.0	8.0	A++
7	7	7	7	28	2.00	2.00	2.00	2.00	2.4	8.00	10.1	0.45	2.05	3.25	3.90	8.0	8.5	A+++
7	7	7	9	30	1.87	1.87	1.87	2.39	2.4	8.00	10.1	0.45	2.05	3.25	3.90	8.0	8.5	A+++
7	7	7	12	33	1.70	1.70	1.70	2.90	2.4	8.00	10.1	0.45	2.05	3.25	3.90	8.0	8.5	A+++
7	7	7	14	35	1.60	1.60	1.60	3.20	2.4	8.00	10.1	0.45	2.05	3.25	3.90	8.0	8.5	A+++
7	7	7	18	39	1.44	1.44	1.44	3.68	2.4	8.00	10.1	0.45	2.05	3.25	3.90	8.0	8.5	A+++
7	7	9	9	32	1.75	1.75	2.25	2.25	2.4	8.00	10.1	0.45	2.05	3.25	3.90	8.0	8.5	A+++
7	7	9	12	35	1.60	1.60	2.06	2.74	2.4	8.00	10.1	0.45	2.05	3.25	3.90	8.0	8.5	A+++
7	7	9	14	37	1.51	1.51	1.95	3.03	2.4	8.00	10.1	0.45	2.05	3.25	3.90	8.0	8.5	A+++
7	7	9	18	41	1.37	1.37	1.76	3.50	2.4	8.00	10.1	0.45	2.05	3.25	3.90	8.0	8.5	A+++

Combination of indoor unit					Rated capacity for each indoor unit (kW)				Total capacity (kW)			Input power (kW)			EER (W/W)	Seasonal data		
Room				Total	Room				Min.	Rated	Max.	Min.	Rated	Max.		Pdesign (kW)	SEER (kWh/kWh)	Energy efficiency class
11	2	3	4		2	3	4	4										
7	7	12	12	38	1.47	1.47	2.53	2.53	2.4	8.00	10.1	0.45	2.05	3.25	3.90	8.0	8.5	A+++
7	7	12	14	40	1.40	1.40	2.40	2.80	2.4	8.00	10.1	0.45	2.05	3.25	3.90	8.0	8.5	A+++
7	7	12	18	44	1.27	1.27	2.18	3.28	2.4	8.00	10.1	0.45	2.05	3.25	3.90	8.0	8.5	A+++
7	7	14	14	42	1.33	1.33	2.67	2.67	2.4	8.00	10.1	0.45	2.05	3.25	3.90	8.0	8.5	A+++
7	7	14	18	46	1.22	1.22	2.43	3.13	2.4	8.00	10.1	0.45	2.05	3.25	3.90	8.0	8.5	A+++
7	9	9	9	34	1.64	2.12	2.12	2.12	2.4	8.00	10.1	0.45	2.05	3.25	3.90	8.0	8.5	A+++
7	9	9	12	37	1.51	1.95	1.95	2.59	2.4	8.00	10.1	0.45	2.05	3.25	3.90	8.0	8.5	A+++
7	9	9	14	39	1.43	1.85	1.85	2.87	2.4	8.00	10.1	0.45	2.05	3.25	3.90	8.0	8.5	A+++
7	9	9	18	43	1.30	1.67	1.67	3.36	2.4	8.00	10.1	0.45	2.05	3.25	3.90	8.0	8.5	A+++
7	9	12	12	40	1.40	1.80	2.40	2.40	2.4	8.00	10.1	0.45	2.05	3.25	3.90	8.0	8.5	A+++
7	9	12	14	42	1.33	1.71	2.29	2.67	2.4	8.00	10.1	0.45	2.05	3.25	3.90	8.0	8.5	A+++
7	9	12	18	46	1.21	1.57	2.09	3.13	2.4	8.00	10.1	0.45	2.05	3.25	3.90	8.0	8.5	A+++
7	9	14	14	44	1.26	1.64	2.55	2.55	2.4	8.00	10.1	0.45	2.05	3.25	3.90	8.0	8.5	A+++
7	9	14	18	48	1.17	1.50	2.33	3.00	2.4	8.00	10.1	0.45	2.05	3.25	3.90	8.0	8.5	A+++
7	12	12	12	43	1.31	2.23	2.23	2.23	2.4	8.00	10.1	0.45	2.05	3.25	3.90	8.0	8.5	A+++
7	12	12	14	45	1.24	2.13	2.13	2.50	2.4	8.00	10.1	0.45	2.05	3.25	3.90	8.0	8.5	A+++
7	12	12	18	49	1.14	1.96	1.96	2.94	2.4	8.00	10.1	0.45	2.05	3.25	3.90	8.0	8.5	A+++
7	12	14	14	47	1.19	2.05	2.38	2.38	2.4	8.00	10.1	0.45	2.05	3.25	3.90	8.0	8.5	A+++
9	9	9	9	36	2.00	2.00	2.00	2.00	2.4	8.00	10.1	0.45	2.05	3.25	3.90	8.0	8.5	A+++
9	9	9	12	39	1.85	1.85	1.85	2.45	2.4	8.00	10.1	0.45	2.05	3.25	3.90	8.0	8.5	A+++
9	9	9	14	41	1.76	1.76	1.76	2.72	2.4	8.00	10.1	0.45	2.05	3.25	3.90	8.0	8.5	A+++
9	9	9	18	45	1.60	1.60	1.60	3.20	2.4	8.00	10.1	0.45	2.05	3.25	3.90	8.0	8.5	A+++
9	9	12	12	42	1.71	1.71	2.29	2.29	2.4	8.00	10.1	0.45	2.05	3.25	3.90	8.0	8.5	A+++
9	9	12	14	44	1.64	1.64	2.18	2.54	2.4	8.00	10.1	0.45	2.05	3.25	3.90	8.0	8.5	A+++
9	9	12	18	48	1.50	1.50	2.00	3.00	2.4	8.00	10.1	0.45	2.05	3.25	3.90	8.0	8.5	A+++
9	9	14	14	46	1.57	1.57	2.43	2.43	2.4	8.00	10.1	0.45	2.05	3.25	3.90	8.0	8.5	A+++
9	12	12	12	45	1.61	2.13	2.13	2.13	2.4	8.00	10.1	0.45	2.05	3.25	3.90	8.0	8.5	A+++
9	12	12	14	47	1.53	2.04	2.04	2.39	2.4	8.00	10.1	0.45	2.05	3.25	3.90	8.0	8.5	A+++
9	12	14	14	49	1.46	1.96	2.29	2.29	2.4	8.00	10.1	0.45	2.05	3.25	3.90	8.0	8.5	A+++
12	12	12	12	48	2.00	2.00	2.00	2.00	2.4	8.00	10.1	0.45	2.05	3.25	3.90	8.0	8.5	A+++

NOTES:

- 7: 7,000 Btu/h, 9: 9,000 Btu/h, 12: 12,000 Btu/h, 14: 14,000 Btu/h, 18: 18,000 Btu/h, 24: 24,000 Btu/h
- Values mentioned in the table are based on the following conditions:
 - Power source of specifications: 230 V
 - Pipe length: 5 m, Height difference: 0 m (Outdoor unit—Indoor unit)
 - Cooling: Indoor temperature of 27 °CDB/19 °CWB, and outdoor temperature of 35 °CDB.
- 2 or more indoor units should be connected.
- The total ability of connected a indoor unit is from 25,000 Btu up to 49,000 Btu.

● Heating

Combination of indoor unit					Rated capacity for each indoor unit (kW)				Total capacity (kW)			Input power (kW)			COP (W/W)	Seasonal data		
Room				Total	Room				Min.	Rated	Max.	Min.	Rated	Max.		Pdesign (kW)	SCOP (kWh/kWh)	Energy efficiency class
1	2	3	4		1	2	3	4										
7	22	—	—	29	2.40	7.20	—	—	3.0	9.60	11.2	0.30	2.47	2.95	3.89	6.5	4.1	A+
7	24	—	—	31	2.17	7.43	—	—	3.0	9.60	11.2	0.30	2.47	2.95	3.89	6.5	4.1	A+
9	22	—	—	31	2.79	6.81	—	—	3.0	9.60	11.2	0.30	2.47	2.95	3.89	6.5	4.1	A+
9	24	—	—	33	2.62	6.98	—	—	3.0	9.60	11.2	0.30	2.47	2.95	3.89	6.5	4.1	A+
12	18	—	—	30	3.84	5.76	—	—	3.0	9.60	11.2	0.30	2.47	2.95	3.89	6.5	4.1	A+
12	22	—	—	34	3.39	6.21	—	—	3.0	9.60	11.2	0.30	2.47	2.95	3.89	6.5	4.1	A+
12	24	—	—	36	3.20	6.40	—	—	3.0	9.60	11.2	0.30	2.47	2.95	3.89	6.5	4.1	A+
14	18	—	—	32	4.20	5.40	—	—	3.0	9.60	11.2	0.30	2.47	2.95	3.89	6.5	4.1	A+
14	22	—	—	36	3.73	5.87	—	—	3.0	9.60	11.2	0.30	2.47	2.95	3.89	6.5	4.1	A+
14	24	—	—	38	3.54	6.06	—	—	3.0	9.60	11.2	0.30	2.47	2.95	3.89	6.5	4.1	A+
18	18	—	—	36	4.80	4.80	—	—	3.0	9.60	11.2	0.30	2.47	2.95	3.89	6.5	4.1	A+
18	22	—	—	40	4.32	5.28	—	—	3.0	9.60	11.2	0.30	2.47	2.95	3.89	6.5	4.1	A+
18	24	—	—	42	4.11	5.49	—	—	3.0	9.60	11.2	0.30	2.47	2.95	3.89	6.5	4.1	A+
22	22	—	—	44	4.80	4.80	—	—	3.0	9.60	11.2	0.30	2.47	2.95	3.89	6.5	4.1	A+
22	24	—	—	46	4.59	5.01	—	—	3.0	9.60	11.2	0.30	2.47	2.95	3.89	6.5	4.1	A+
24	24	—	—	48	4.80	4.80	—	—	3.0	9.60	11.2	0.30	2.47	2.95	3.89	6.5	4.1	A+
7	7	12	—	26	2.40	2.40	4.20	—	3.0	9.00	10.4	0.30	2.11	2.60	4.27	6.0	4.4	A+
7	7	14	—	28	2.40	2.40	4.80	—	3.0	9.60	11.2	0.30	2.27	2.95	4.22	6.5	4.3	A+
7	7	18	—	32	2.10	2.10	5.40	—	3.0	9.60	11.2	0.30	2.27	2.95	4.22	6.5	4.3	A+
7	7	22	—	36	1.87	1.87	5.86	—	3.0	9.60	11.2	0.30	2.27	2.95	4.22	6.5	4.3	A+
7	7	24	—	38	1.77	1.77	6.06	—	3.0	9.60	11.2	0.30	2.27	2.95	4.22	6.5	4.3	A+
7	9	9	—	25	2.40	3.00	3.00	—	3.0	8.40	10.0	0.30	1.94	2.45	4.32	6.0	4.4	A+
7	9	12	—	28	2.40	3.00	4.20	—	3.0	9.60	11.2	0.30	2.27	2.95	4.22	6.5	4.3	A+
7	9	14	—	30	2.24	2.88	4.48	—	3.0	9.60	11.2	0.30	2.27	2.95	4.22	6.5	4.3	A+
7	9	18	—	34	1.98	2.54	5.08	—	3.0	9.60	11.2	0.30	2.27	2.95	4.22	6.5	4.3	A+
7	9	22	—	38	1.77	2.27	5.56	—	3.0	9.60	11.2	0.30	2.27	2.95	4.22	6.5	4.3	A+
7	9	24	—	40	1.68	2.16	5.76	—	3.0	9.60	11.2	0.30	2.27	2.95	4.22	6.5	4.3	A+
7	12	12	—	31	2.16	3.72	3.72	—	3.0	9.60	11.2	0.30	2.27	2.95	4.22	6.5	4.3	A+
7	12	14	—	33	2.04	3.49	4.07	—	3.0	9.60	11.2	0.30	2.27	2.95	4.22	6.5	4.3	A+
7	12	18	—	37	1.82	3.11	4.67	—	3.0	9.60	11.2	0.30	2.27	2.95	4.22	6.5	4.3	A+
7	12	22	—	41	1.64	2.81	5.15	—	3.0	9.60	11.2	0.30	2.27	2.95	4.22	6.5	4.3	A+
7	12	24	—	43	1.56	2.68	5.36	—	3.0	9.60	11.2	0.30	2.27	2.95	4.22	6.5	4.3	A+
7	14	14	—	35	1.92	3.84	3.84	—	3.0	9.60	11.2	0.30	2.27	2.95	4.22	6.5	4.3	A+
7	14	18	—	39	1.72	3.45	4.43	—	3.0	9.60	11.2	0.30	2.27	2.95	4.22	6.5	4.3	A+
7	14	22	—	43	1.56	3.13	4.91	—	3.0	9.60	11.2	0.30	2.27	2.95	4.22	6.5	4.3	A+
7	14	24	—	45	1.49	2.99	5.12	—	3.0	9.60	11.2	0.30	2.27	2.95	4.22	6.5	4.3	A+
7	18	18	—	43	1.56	4.02	4.02	—	3.0	9.60	11.2	0.30	2.27	2.95	4.22	6.5	4.3	A+
7	18	22	—	47	1.43	3.68	4.49	—	3.0	9.60	11.2	0.30	2.27	2.95	4.22	6.5	4.3	A+
7	18	24	—	49	1.37	3.53	4.70	—	3.0	9.60	11.2	0.30	2.27	2.95	4.22	6.5	4.3	A+
9	9	9	—	27	3.00	3.00	3.00	—	3.0	9.00	10.8	0.30	2.11	2.76	4.27	6.0	4.4	A+
9	9	12	—	30	2.88	2.88	3.84	—	3.0	9.60	11.2	0.30	2.27	2.95	4.22	6.5	4.3	A+
9	9	14	—	32	2.70	2.70	4.20	—	3.0	9.60	11.2	0.30	2.27	2.95	4.22	6.5	4.3	A+
9	9	18	—	36	2.40	2.40	4.80	—	3.0	9.60	11.2	0.30	2.27	2.95	4.22	6.5	4.3	A+
9	9	22	—	40	2.16	2.16	5.28	—	3.0	9.60	11.2	0.30	2.27	2.95	4.22	6.5	4.3	A+
9	9	24	—	42	2.06	2.06	5.48	—	3.0	9.60	11.2	0.30	2.27	2.95	4.22	6.5	4.3	A+
9	12	12	—	33	2.62	3.49	3.49	—	3.0	9.60	11.2	0.30	2.27	2.95	4.22	6.5	4.3	A+
9	12	14	—	35	2.47	3.29	3.84	—	3.0	9.60	11.2	0.30	2.27	2.95	4.22	6.5	4.3	A+
9	12	18	—	39	2.22	2.95	4.43	—	3.0	9.60	11.2	0.30	2.27	2.95	4.22	6.5	4.3	A+
9	12	22	—	43	2.01	2.68	4.91	—	3.0	9.60	11.2	0.30	2.27	2.95	4.22	6.5	4.3	A+
9	12	24	—	45	1.92	2.56	5.12	—	3.0	9.60	11.2	0.30	2.27	2.95	4.22	6.5	4.3	A+
9	14	14	—	37	2.34	3.63	3.63	—	3.0	9.60	11.2	0.30	2.27	2.95	4.22	6.5	4.3	A+
9	14	18	—	41	2.11	3.28	4.21	—	3.0	9.60	11.2	0.30	2.27	2.95	4.22	6.5	4.3	A+
9	14	22	—	45	1.92	2.99	4.69	—	3.0	9.60	11.2	0.30	2.27	2.95	4.22	6.5	4.3	A+
9	14	24	—	47	1.84	2.86	4.90	—	3.0	9.60	11.2	0.30	2.27	2.95	4.22	6.5	4.3	A+
12	12	12	—	36	3.20	3.20	3.20	—	3.0	9.60	11.2	0.30	2.27	2.95	4.22	6.5	4.3	A+
12	12	14	—	38	3.03	3.03	3.54	—	3.0	9.60	11.2	0.30	2.27	2.95	4.22	6.5	4.3	A+
12	12	18	—	42	2.74	2.74	4.12	—	3.0	9.60	11.2	0.30	2.27	2.95	4.22	6.5	4.3	A+
12	12	22	—	46	2.50	2.50	4.60	—	3.0	9.60	11.2	0.30	2.27	2.95	4.22	6.5	4.3	A+
12	12	24	—	48	2.40	2.40	4.80	—	3.0	9.60	11.2	0.30	2.27	2.95	4.22	6.5	4.3	A+
12	14	14	—	40	2.88	3.36	3.36	—	3.0	9.60	11.2	0.30	2.27	2.95	4.22	6.5	4.3	A+
12	14	18	—	44	2.62	3.05	3.93	—	3.0	9.60	11.2	0.30	2.27	2.95	4.22	6.5	4.3	A+
12	18	18	—	48	2.40	3.60	3.60	—	3.0	9.60	11.2	0.30	2.27	2.95	4.22	6.5	4.3	A+
14	14	14	—	42	3.20	3.20	3.20	—	3.0	9.60	11.2	0.30	2.27	2.95	4.22	6.5	4.3	A+
14	14	18	—	46	2.92	2.92	3.76	—	3.0	9.60	11.2	0.30	2.27	2.95	4.22	6.5	4.3	A+
7	7	7	7	28	2.40	2.40	2.40	2.40	3.0	9.60	11.2	0.30	2.11	2.95	4.55	6.5	4.6	A++
7	7	7	9	30	2.24	2.24	2.24	2.88	3.0	9.60	11.2	0.30	2.11	2.95	4.55	6.5	4.6	A++
7	7	7	12	33	2.04	2.04	2.04	3.48	3.0	9.60	11.2	0.30	2.11	2.95	4.55	6.5	4.6	A++
7	7	7	14	35	1.92	1.92	1.92	3.84	3.0	9.60	11.2	0.30	2.11	2.95	4.55	6.5	4.6	A++
7	7	7	18	39	1.72	1.72	1.72	4.44	3.0	9.60	11.2	0.30	2.11	2.95	4.55	6.5	4.6	A++
7	7	7	9	32	2.10	2.10	2.70	2.70	3.0	9.60	11.2	0.30	2.11	2.95	4.55	6.5	4.6	A++
7	7	7	9	35	1.92	1.92	2.47	3.29	3.0	9.60	11.2	0.30	2.11	2.95	4.55	6.5	4.6	A++
7	7	7	9	37	1.82	1.82	2.34	3.62	3.0	9.60	11.2	0.30	2.11	2.95	4.55	6.5	4.6	A++
7	7	7	9	41	1.64	1.64	2.11	4.21	3.0	9.60	11.2	0.30	2.11	2.95	4.55	6.5	4.6	A++
7	7	7	12	38	1.77	1.77	3.03	3.03	3.0	9.60	11.2	0.30	2.11	2.95	4.55	6.5	4.6	A++
7	7	7	12	40	1.68	1.68	2.88	3.36	3.0	9.60	11.2	0.30	2.11	2.95	4.55	6.5	4.6	A++
7	7	7	12	44	1.53	1.53	2.62	3.92	3.0	9.60	11.2	0.30	2.11	2.95	4.55	6.5	4.6	A++
7	7	7	14	42	1.60	1.60	3.20	3.20	3.0	9.60	11.2	0.30	2.11	2.95	4.55	6.5	4.6	A++
7	7	7	14	46	1.46	1.46	2.92	3.76	3.0	9.60	11.2	0.30	2.11	2.95	4.55	6.5	4.6	A++

Combination of indoor unit					Rated capacity for each indoor unit (kW)				Total capacity (kW)			Input power (kW)			COP (W/W)	Seasonal data		
Room				Total	Room				Min.	Rated	Max.	Min.	Rated	Max.		Pdesign (kW)	SCOP (kWh/kWh)	Energy efficiency class
1	2	3	4		1	2	3	4										
7	9	14	18	48	1.40	1.80	2.80	3.60	3.0	9.60	11.2	0.30	2.11	2.95	4.55	6.5	4.6	A++
7	12	12	12	43	1.56	2.68	2.68	2.68	3.0	9.60	11.2	0.30	2.11	2.95	4.55	6.5	4.6	A++
7	12	12	14	45	1.49	2.56	2.56	2.99	3.0	9.60	11.2	0.30	2.11	2.95	4.55	6.5	4.6	A++
7	12	12	18	49	1.37	2.35	2.35	3.53	3.0	9.60	11.2	0.30	2.11	2.95	4.55	6.5	4.6	A++
7	12	14	14	47	1.43	2.45	2.86	2.86	3.0	9.60	11.2	0.30	2.11	2.95	4.55	6.5	4.6	A++
9	9	9	9	36	2.40	2.40	2.40	2.40	3.0	9.60	11.2	0.30	2.11	2.95	4.55	6.5	4.6	A++
9	9	9	12	39	2.22	2.22	2.22	2.94	3.0	9.60	11.2	0.30	2.11	2.95	4.55	6.5	4.6	A++
9	9	9	14	41	2.11	2.11	2.11	3.27	3.0	9.60	11.2	0.30	2.11	2.95	4.55	6.5	4.6	A++
9	9	9	18	45	1.92	1.92	1.92	3.84	3.0	9.60	11.2	0.30	2.11	2.95	4.55	6.5	4.6	A++
9	9	12	12	42	2.06	2.06	2.74	2.74	3.0	9.60	11.2	0.30	2.11	2.95	4.55	6.5	4.6	A++
9	9	12	14	44	1.96	1.96	2.62	3.06	3.0	9.60	11.2	0.30	2.11	2.95	4.55	6.5	4.6	A++
9	9	12	18	48	1.80	1.80	2.40	3.60	3.0	9.60	11.2	0.30	2.11	2.95	4.55	6.5	4.6	A++
9	9	14	14	46	1.88	1.88	2.92	2.92	3.0	9.60	11.2	0.30	2.11	2.95	4.55	6.5	4.6	A++
9	12	12	12	45	1.92	2.56	2.56	2.56	3.0	9.60	11.2	0.30	2.11	2.95	4.55	6.5	4.6	A++
9	12	12	14	47	1.84	2.45	2.45	2.86	3.0	9.60	11.2	0.30	2.11	2.95	4.55	6.5	4.6	A++
9	12	14	14	49	1.77	2.35	2.74	2.74	3.0	9.60	11.2	0.30	2.11	2.95	4.55	6.5	4.6	A++
12	12	12	12	48	2.40	2.40	2.40	2.40	3.0	9.60	11.2	0.30	2.11	2.95	4.55	6.5	4.6	A++

NOTES:

- 7: 7,000 Btu/h, 9: 9,000 Btu/h, 12: 12,000 Btu/h, 14: 14,000 Btu/h, 18: 18,000 Btu/h, 24: 24,000 Btu/h
- Values mentioned in the table are based on the following conditions:
 - Power source of specifications: 230 V
 - Pipe length: 5 m, Height difference: 0 m (Outdoor unit—Indoor unit)
 - Heating: Indoor temperature of 20 °CDB, and outdoor temperature of 7 °CDB/6 °CWB.
- 2 or more indoor units should be connected.
- The total ability of connected a indoor unit is from 25,000 Btu up to 49,000 Btu.

6-2. Cooling capacity

NOTE: Values mentioned in the table are calculated based on the maximum capacity.

Model: AOYG30KBTA4

OUTDOOR UNIT
AOYG30KBTA4

OUTDOOR UNIT
AOYG30KBTA4

Indoor unit connect- ing capacity	Outdoor temperature	Indoor temperature											
		18.0 °CDB		21.0 °CDB		23.0 °CDB		27.0 °CDB		29.0 °CDB		32.0 °CDB	
		12.0 °CWB		15.0 °CWB		16.0 °CWB		19.0 °CWB		21.0 °CWB		23.0 °CWB	
kBtu/h	°CDB	TC	IP	TC	IP	TC	IP	TC	IP	TC	IP	TC	IP
49	-10.0	7.9	1.94	8.9	1.97	9.4	1.99	10.1	2.01	10.8	2.03	11.1	2.05
	0.0	7.9	2.02	8.9	2.05	9.4	2.07	10.1	2.09	10.8	2.11	11.1	2.13
	5.0	7.9	1.98	8.9	2.02	9.4	2.03	10.1	2.05	10.8	2.08	11.1	2.09
	10.0	7.9	2.11	8.9	2.14	9.4	2.16	10.1	2.19	10.8	2.21	11.1	2.22
	15.0	7.9	2.00	8.9	2.04	9.4	2.05	10.1	2.08	10.8	2.10	11.1	2.11
	20.0	7.9	1.89	8.9	1.93	9.4	1.94	10.1	1.97	10.8	1.99	11.1	2.00
	25.0	7.9	2.29	8.9	2.33	9.4	2.35	10.1	2.38	10.8	2.40	11.1	2.42
	30.0	7.9	2.74	8.9	2.79	9.4	2.82	10.1	2.85	10.8	2.88	11.1	2.90
	35.0	7.9	3.18	8.9	3.24	9.4	3.26	10.1	3.30	10.8	3.34	11.1	3.35
	40.0	6.6	2.69	7.4	2.74	7.8	2.76	8.4	2.79	8.9	2.82	9.2	2.84
46.0	5.2	2.20	5.9	2.24	6.2	2.25	6.6	2.28	7.1	2.31	7.3	2.32	
48	-10.0	7.9	1.94	8.9	1.97	9.4	1.99	10.1	2.01	10.8	2.03	11.1	2.05
	0.0	7.9	2.02	8.9	2.05	9.4	2.07	10.1	2.09	10.8	2.11	11.1	2.13
	5.0	7.9	1.98	8.9	2.02	9.4	2.03	10.1	2.05	10.8	2.08	11.1	2.09
	10.0	7.9	2.11	8.9	2.14	9.4	2.16	10.1	2.19	10.8	2.21	11.1	2.22
	15.0	7.9	2.00	8.9	2.04	9.4	2.05	10.1	2.08	10.8	2.10	11.1	2.11
	20.0	7.9	1.89	8.9	1.93	9.4	1.94	10.1	1.97	10.8	1.99	11.1	2.00
	25.0	7.9	2.29	8.9	2.33	9.4	2.35	10.1	2.38	10.8	2.40	11.1	2.42
	30.0	7.9	2.74	8.9	2.79	9.4	2.82	10.1	2.85	10.8	2.88	11.1	2.90
	35.0	7.9	3.18	8.9	3.24	9.4	3.26	10.1	3.30	10.8	3.34	11.1	3.35
	40.0	6.6	2.69	7.4	2.74	7.8	2.76	8.4	2.79	8.9	2.82	9.2	2.84
46.0	5.2	2.20	5.9	2.24	6.2	2.25	6.6	2.28	7.1	2.31	7.3	2.32	
47	-10.0	7.9	1.94	8.9	1.97	9.4	1.99	10.1	2.01	10.8	2.03	11.1	2.05
	0.0	7.9	2.02	8.9	2.05	9.4	2.07	10.1	2.09	10.8	2.11	11.1	2.13
	5.0	7.9	1.98	8.9	2.02	9.4	2.03	10.1	2.05	10.8	2.08	11.1	2.09
	10.0	7.9	2.11	8.9	2.14	9.4	2.16	10.1	2.19	10.8	2.21	11.1	2.22
	15.0	7.9	2.00	8.9	2.04	9.4	2.05	10.1	2.08	10.8	2.10	11.1	2.11
	20.0	7.9	1.89	8.9	1.93	9.4	1.94	10.1	1.97	10.8	1.99	11.1	2.00
	25.0	7.9	2.29	8.9	2.33	9.4	2.35	10.1	2.38	10.8	2.40	11.1	2.42
	30.0	7.9	2.74	8.9	2.79	9.4	2.82	10.1	2.85	10.8	2.88	11.1	2.90
	35.0	7.9	3.18	8.9	3.24	9.4	3.26	10.1	3.30	10.8	3.34	11.1	3.35
	40.0	6.6	2.69	7.4	2.74	7.8	2.76	8.4	2.79	8.9	2.82	9.2	2.84
46.0	5.2	2.20	5.9	2.24	6.2	2.25	6.6	2.28	7.1	2.31	7.3	2.32	
46	-10.0	7.9	1.94	8.9	1.97	9.4	1.99	10.1	2.01	10.8	2.03	11.1	2.05
	0.0	7.9	2.02	8.9	2.05	9.4	2.07	10.1	2.09	10.8	2.11	11.1	2.13
	5.0	7.9	1.98	8.9	2.02	9.4	2.03	10.1	2.05	10.8	2.08	11.1	2.09
	10.0	7.9	2.11	8.9	2.14	9.4	2.16	10.1	2.19	10.8	2.21	11.1	2.22
	15.0	7.9	2.00	8.9	2.04	9.4	2.05	10.1	2.08	10.8	2.10	11.1	2.11
	20.0	7.9	1.89	8.9	1.93	9.4	1.94	10.1	1.97	10.8	1.99	11.1	2.00
	25.0	7.9	2.29	8.9	2.33	9.4	2.35	10.1	2.38	10.8	2.40	11.1	2.42
	30.0	7.9	2.74	8.9	2.79	9.4	2.82	10.1	2.85	10.8	2.88	11.1	2.90
	35.0	7.9	3.18	8.9	3.24	9.4	3.26	10.1	3.30	10.8	3.34	11.1	3.35
	40.0	6.6	2.69	7.4	2.74	7.8	2.76	8.4	2.79	8.9	2.82	9.2	2.84
46.0	5.2	2.20	5.9	2.24	6.2	2.25	6.6	2.28	7.1	2.31	7.3	2.32	
45	-10.0	7.9	1.94	8.9	1.97	9.4	1.99	10.1	2.01	10.8	2.03	11.1	2.05
	0.0	7.9	2.02	8.9	2.05	9.4	2.07	10.1	2.09	10.8	2.11	11.1	2.13
	5.0	7.9	1.98	8.9	2.02	9.4	2.03	10.1	2.05	10.8	2.08	11.1	2.09
	10.0	7.9	2.11	8.9	2.14	9.4	2.16	10.1	2.19	10.8	2.21	11.1	2.22
	15.0	7.9	2.00	8.9	2.04	9.4	2.05	10.1	2.08	10.8	2.10	11.1	2.11
	20.0	7.9	1.89	8.9	1.93	9.4	1.94	10.1	1.97	10.8	1.99	11.1	2.00
	25.0	7.9	2.29	8.9	2.33	9.4	2.35	10.1	2.38	10.8	2.40	11.1	2.42
	30.0	7.9	2.74	8.9	2.79	9.4	2.82	10.1	2.85	10.8	2.88	11.1	2.90
	35.0	7.9	3.18	8.9	3.24	9.4	3.26	10.1	3.30	10.8	3.34	11.1	3.35
	40.0	6.6	2.69	7.4	2.74	7.8	2.76	8.4	2.79	8.9	2.82	9.2	2.84
46.0	5.2	2.20	5.9	2.24	6.2	2.25	6.6	2.28	7.1	2.31	7.3	2.32	
44	-10.0	7.9	1.94	8.9	1.97	9.4	1.99	10.1	2.01	10.8	2.03	11.1	2.05
	0.0	7.9	2.02	8.9	2.05	9.4	2.07	10.1	2.09	10.8	2.11	11.1	2.13
	5.0	7.9	1.98	8.9	2.02	9.4	2.03	10.1	2.05	10.8	2.08	11.1	2.09
	10.0	7.9	2.11	8.9	2.14	9.4	2.16	10.1	2.19	10.8	2.21	11.1	2.22
	15.0	7.9	2.00	8.9	2.04	9.4	2.05	10.1	2.08	10.8	2.10	11.1	2.11
	20.0	7.9	1.89	8.9	1.93	9.4	1.94	10.1	1.97	10.8	1.99	11.1	2.00
	25.0	7.9	2.29	8.9	2.33	9.4	2.35	10.1	2.38	10.8	2.40	11.1	2.42
	30.0	7.9	2.74	8.9	2.79	9.4	2.82	10.1	2.85	10.8	2.88	11.1	2.90
	35.0	7.9	3.18	8.9	3.24	9.4	3.26	10.1	3.30	10.8	3.34	11.1	3.35
	40.0	6.6	2.69	7.4	2.74	7.8	2.76	8.4	2.79	8.9	2.82	9.2	2.84
46.0	5.2	2.20	5.9	2.24	6.2	2.25	6.6	2.28	7.1	2.31	7.3	2.32	
43	-10.0	7.9	1.94	8.9	1.97	9.4	1.99	10.1	2.01	10.8	2.03	11.1	2.05
	0.0	7.9	2.02	8.9	2.05	9.4	2.07	10.1	2.09	10.8	2.11	11.1	2.13
	5.0	7.9	1.98	8.9	2.02	9.4	2.03	10.1	2.05	10.8	2.08	11.1	2.09
	10.0	7.9	2.11	8.9	2.14	9.4	2.16	10.1	2.19	10.8	2.21	11.1	2.22
	15.0	7.9	2.00	8.9	2.04	9.4	2.05	10.1	2.08	10.8	2.10	11.1	2.11
	20.0	7.9	1.89	8.9	1.93	9.4	1.94	10.1	1.97	10.8	1.99	11.1	2.00
	25.0	7.9	2.29	8.9	2.33	9.4	2.35	10.1	2.38	10.8	2.40	11.1	2.42
	30.0	7.9	2.74	8.9	2.79	9.4	2.82	10.1	2.85	10.8	2.88	11.1	2.90
	35.0	7.9	3.18	8.9	3.24	9.4	3.26	10.1	3.30	10.8	3.34	11.1	3.35
	40.0	6.6	2.69	7.4	2.74	7.8	2.76	8.4	2.79	8.9	2.82	9.2	2.84
46.0	5.2	2.20	5.9	2.24	6.2	2.25	6.6	2.28	7.1	2.31	7.3	2.32	

Indoor unit connect- ing capacity	Outdoor temperature	Indoor temperature											
		18.0 °CDB		21.0 °CDB		23.0 °CDB		27.0 °CDB		29.0 °CDB		32.0 °CDB	
		12.0 °CWB		15.0 °CWB		16.0 °CWB		19.0 °CWB		21.0 °CWB		23.0 °CWB	
kBtu/h	°CDB	TC	IP	TC	IP	TC	IP	TC	IP	TC	IP	TC	IP
34	-10.0	7.9	1.94	8.9	1.97	9.4	1.99	10.1	2.01	10.8	2.03	11.1	2.05
	0.0	7.9	2.02	8.9	2.05	9.4	2.07	10.1	2.09	10.8	2.11	11.1	2.13
	5.0	7.9	1.98	8.9	2.02	9.4	2.03	10.1	2.05	10.8	2.08	11.1	2.09
	10.0	7.9	2.11	8.9	2.14	9.4	2.16	10.1	2.19	10.8	2.21	11.1	2.22
	15.0	7.9	2.00	8.9	2.04	9.4	2.05	10.1	2.08	10.8	2.10	11.1	2.11
	20.0	7.9	1.89	8.9	1.93	9.4	1.94	10.1	1.97	10.8	1.99	11.1	2.00
	25.0	7.9	2.29	8.9	2.33	9.4	2.35	10.1	2.38	10.8	2.40	11.1	2.42
	30.0	7.9	2.74	8.9	2.79	9.4	2.82	10.1	2.85	10.8	2.88	11.1	2.90
	35.0	7.9	3.18	8.9	3.24	9.4	3.26	10.1	3.30	10.8	3.34	11.1	3.35
	40.0	6.6	2.69	7.4	2.74	7.8	2.76	8.4	2.79	8.9	2.82	9.2	2.84
46.0	5.2	2.20	5.9	2.24	6.2	2.25	6.6	2.28	7.1	2.31	7.3	2.32	
33	-10.0	7.9	1.94	8.9	1.97	9.4	1.99	10.1	2.01	10.8	2.03	11.1	2.05
	0.0	7.9	2.02	8.9	2.05	9.4	2.07	10.1	2.09	10.8	2.11	11.1	2.13
	5.0	7.9	1.98	8.9	2.02	9.4	2.03	10.1	2.05	10.8	2.08	11.1	2.09
	10.0	7.9	2.11	8.9	2.14	9.4	2.16	10.1	2.19	10.8	2.21	11.1	2.22
	15.0	7.9	2.00	8.9	2.04	9.4	2.05	10.1	2.08	10.8	2.10	11.1	2.11
	20.0	7.9	1.89	8.9	1.93	9.4	1.94	10.1	1.97	10.8	1.99	11.1	2.00
	25.0	7.9	2.29	8.9	2.33	9.4	2.35	10.1	2.38	10.8	2.40	11.1	2.42
	30.0	7.9	2.74	8.9	2.79	9.4	2.82	10.1	2.85	10.8	2.88	11.1	2.90
	35.0	7.9	3.18	8.9	3.24	9.4	3.26	10.1	3.30	10.8	3.34	11.1	3.35
	40.0	6.6	2.69	7.4	2.74	7.8	2.76	8.4	2.79	8.9	2.82	9.2	2.84
46.0	5.2	2.20	5.9	2.24	6.2	2.25	6.6	2.28	7.1	2.31	7.3	2.32	
32	-10.0	7.9	1.94	8.9	1.97	9.4	1.99	10.1	2.01	10.8	2.03	11.1	2.05
	0.0	7.9	2.02	8.9	2.05	9.4	2.07	10.1	2.09	10.8	2.11	11.1	2.13
	5.0	7.9	1.98	8.9	2.02	9.4	2.03	10.1	2.05	10.8	2.08	11.1	2.09
	10.0	7.9	2.11	8.9	2.14	9.4	2.16	10.1	2.19	10.8	2.21	11.1	2.22
	15.0	7.9	2.00	8.9	2.04	9.4	2.05	10.1	2.08	10.8	2.10	11.1	2.11
	20.0	7.9	1.89	8.9	1.93	9.4	1.94	10.1	1.97	10.8	1.99	11.1	2.00
	25.0	7.9	2.29	8.9	2.33	9.4	2.35	10.1	2.38	10.8	2.40	11.1	2.42
	30.0	7.9	2.74	8.9	2.79	9.4	2.82	10.1	2.85	10.8	2.88	11.1	2.90
	35.0	7.9	3.18	8.9	3.24	9.4	3.26	10.1	3.30	10.8	3.34	11.1	3.35
	40.0	6.6	2.69	7.4	2.74	7.8	2.76	8.4	2.79	8.9	2.82	9.2	2.84
46.0	5.2	2.20	5.9	2.24	6.2	2.25	6.6	2.28	7.1	2.31	7.3	2.32	
31	-10.0	7.9	1.94	8.9	1.97	9.4	1.99	10.1	2.01	10.8	2.03	11.1	2.05
	0.0	7.9	2.02	8.9	2.05	9.4	2.07	10.1	2.09	10.8	2.11	11.1	2.13
	5.0	7.9	1.98	8.9	2.02	9.4	2.03	10.1	2.05	10.8	2.08	11.1	2.09
	10.0	7.9	2.11	8.9	2.14	9.4	2.16	10.1	2.19	10.8	2.21	11.1	2.22
	15.0	7.9	2.00	8.9	2.04	9.4	2.05	10.1	2.08	10.8	2.10	11.1	2.11
	20.0	7.9	1.89	8.9	1.93	9.4	1.94	10.1	1.97	10.8	1.99	11.1	2.00
	25.0	7.9	2.29	8.9	2.33	9.4	2.35	10.1	2.38	10.8	2.40	11.1	2.42
	30.0	7.9	2.74	8.9	2.79	9.4	2.82	10.1	2.85	10.8	2.88	11.1	2.90
	35.0	7.9	3.18	8.9	3.24	9.4	3.26	10.1	3.30	10.8	3.34	11.1	3.35
	40.0	6.6	2.69	7.4	2.74	7.8	2.76	8.4	2.79	8.9	2.82	9.2	2.84
46.0	5.2	2.20	5.9	2.24	6.2	2.25	6.6	2.28	7.1	2.31	7.3	2.32	
30	-10.0	7.9	1.94	8.9	1.97	9.4	1.99	10.1	2.01	10.8	2.03	11.1	2.05
	0.0	7.9	2.02	8.9	2.05	9.4	2.07	10.1	2.09	10.8	2.11	11.1	2.13
	5.0	7.9	1.98	8.9	2.02	9.4	2.03	10.1	2.05	10.8	2.08	11.1	2.09
	10.0	7.9	2.11	8.9	2.14	9.4	2.16	10.1	2.19	10.8	2.21	11.1	2.22
	15.0	7.9	2.00	8.9	2.04	9.4	2.05	10.1	2.08	10.8	2.10	11.1	2.11
	20.0	7.9	1.89	8.9	1.93	9.4	1.94	10.1	1.97	10.8	1.99	11.1	2.00
	25.0	7.9	2.29	8.9	2.33	9.4	2.35	10.1	2.38	10.8	2.40	11.1	2.42
	30.0	7.9	2.74	8.9	2.79	9.4	2.82	10.1	2.85	10.8	2.88	11.1	2.90
	35.0	7.9	3.18	8.9	3.24	9.4	3.26	10.1	3.30	10.8	3.34	11.1	3.35
	40.0	6.6	2.69	7.4	2.74	7.8	2.76	8.4	2.79	8.9	2.82	9.2	2.84
46.0	5.2	2.20	5.9	2.24	6.2	2.25	6.6	2.28	7.1	2.31	7.3	2.32	
29	-10.0	7.9	1.94	8.9	1.97	9.4	1.99	10.1	2.01	10.8	2.03	11.1	2.05
	0.0	7.9	2.02	8.9	2.05	9.4	2.07	10.1	2.09	10.8	2.11	11.1	2.13
	5.0	7.9	1.98	8.9	2.02	9.4	2.03	10.1	2.05	10.8	2.08	11.1	2.09
	10.0	7.9	2.11	8.9	2.14	9.4	2.16	10.1	2.19	10.8	2.21	11.1	2.22
	15.0	7.9	2.00	8.9	2.04	9.4	2.05	10.1	2.08	10.8	2.10	11.1	2.11
	20.0	7.9	1.89	8.9	1.93	9.4	1.94	10.1	1.97	10.8	1.99	11.1	2.00
	25.0	7.9	2.29	8.9	2.33	9.4	2.35	10.1	2.38	10.8	2.40	11.1	2.42
	30.0	7.9	2.74	8.9	2.79	9.4	2.82	10.1	2.85	10.8	2.88	11.1	2.90
	35.0	7.9	3.18	8.9	3.24	9.4	3.26	10.1	3.30	10.8	3.34	11.1	3.35
	40.0	6.6	2.69	7.4	2.74	7.8	2.76	8.4	2.79	8.9	2.82	9.2	2.84
46.0	5.2	2.20	5.9	2.24	6.2	2.25	6.6	2.28	7.1	2.31	7.3	2.32	
28	-10.0	7.9	1.94	8.9	1.97	9.4	1.99	10.1	2.01	10.8	2.03	11.1	2.05
	0.0	7.9	2.02	8.9	2.05	9.4	2.07	10.1	2.09	10.8	2.11	11.1	2.13
	5.0	7.9	1.98	8.9	2.02	9.4	2.03	10.1	2.05	10.8	2.08	11.1	2.09
	10.0	7.9	2.11	8.9	2.14	9.4	2.16	10.1	2.19	10.8	2.21	11.1	2.22
	15.0	7.9	2.00	8.9	2.04	9.4	2.05	10.1	2.08	10.8	2.10	11.1	2.11
	20.0	7.9	1.89	8.9	1.93	9.4	1.94	10.1	1.97	10.8	1.99	11.1	2.00
	25.0	7.9	2.29	8.9	2.33	9.4	2.35	10.1	2.38	10.8	2.40	11.1	2.42
	30.0	7.9	2.74	8.9	2.79	9.4	2.82	10.1	2.85	10.8	2.88	11.1	2.90
	35.0	7.9	3.18	8.9	3.24	9.4	3.26	10.1	3.30	10.8	3.34	11.1	3.35
	40.0	6.6	2.69	7.4	2.74	7.8	2.76	8.4	2.79	8.9	2.82	9.2	2.84
46.0	5.2	2.20	5.9	2.24	6.2	2.25	6.6	2.28	7.1	2.31	7.3	2.32	
27	-10.0	7.5	1.77	8.5	1.80	9.0	1.81	9.6	1.83	10.3	1.85	10.6	1.86
	0.0	7.5	1.84	8.5	1.87	9.0	1.88	9.6	1.90	10.3	1.93	10.6	1.94
	5.0	7.5	1.80	8.5	1.84	9.0	1.85	9.6	1.87	10.3	1.89	10.6	1.90
	10.0	7.5	1.92	8.5	1.95	9.0	1.97	9.6	1.99	10.3	2.01	10.6	2.03
	15.0	7.5	1.82	8.5	1.86	9.0	1.87	9.6	1.89	10.3	1.91	10.6	1.92
	20.0	7.5	1.73	8.5	1.76	9.0	1.77	9.6	1.79	10.3	1.81	10.6	1.82
	25.0	7.5	2.09	8.5	2.12	9.0	2.14	9.6	2.17	10.3	2.19	10.6	2.20
	30.0	7.5	2.50	8.5	2.54	9.0	2.57	9.6	2.59	10.3	2.62	10.6	2.64
	35.0	7.5	2.90	8.5	2.95	9.0	2.97	9.6	3.00	10.3	3.04	10.6	3.06
	40.0	6.2	2.45	7.0	2.49	7.4	2.51	7.9	2.54	8.5	2.57	8.8	2.58
46.0	6.2	2.00	7.0	2.04	7.4	2.05	7.9	2.08	8.5	2.10	8.8	2.11	

OUTDOOR UNIT
AOYG30KETA4

OUTDOOR UNIT
AOYG30KETA4

Indoor unit connect- ing capacity	Outdoor temperature	Indoor temperature											
		18.0 °CDB		21.0 °CDB		23.0 °CDB		27.0 °CDB		29.0 °CDB		32.0 °CDB	
		12.0 °CWB		15.0 °CWB		16.0 °CWB		19.0 °CWB		21.0 °CWB		23.0 °CWB	
kBtu/h	°CDB	TC	IP	TC	IP	TC	IP	TC	IP	TC	IP	TC	IP
26	-10.0	7.3	1.71	8.2	1.74	8.7	1.76	9.3	1.78	9.9	1.80	10.2	1.81
	0.0	7.3	1.78	8.2	1.81	8.7	1.83	9.3	1.85	9.9	1.87	10.2	1.88
	5.0	7.3	1.75	8.2	1.78	8.7	1.79	9.3	1.81	9.9	1.84	10.2	1.84
	10.0	7.3	1.86	8.2	1.89	8.7	1.91	9.3	1.93	9.9	1.95	10.2	1.96
	15.0	7.3	1.77	8.2	1.80	8.7	1.81	9.3	1.83	9.9	1.86	10.2	1.87
	20.0	7.3	1.67	8.2	1.70	8.7	1.72	9.3	1.74	9.9	1.76	10.2	1.76
	25.0	7.3	2.02	8.2	2.06	8.7	2.08	9.3	2.10	9.9	2.12	10.2	2.13
	30.0	7.3	2.42	8.2	2.47	8.7	2.49	9.3	2.51	9.9	2.54	10.2	2.56
	35.0	7.3	2.81	8.2	2.86	8.7	2.88	9.3	2.91	9.9	2.95	10.2	2.96
	40.0	6.0	2.37	6.8	2.42	7.2	2.44	7.7	2.46	8.2	2.49	8.5	2.50
25	46.0	6.0	1.94	6.8	1.97	7.2	1.99	7.7	2.01	8.2	2.04	8.5	2.05
	-10.0	7.0	1.64	7.9	1.67	8.3	1.68	8.9	1.70	9.5	1.72	9.8	1.73
	0.0	7.0	1.70	7.9	1.73	8.3	1.75	8.9	1.77	9.5	1.79	9.8	1.80
	5.0	7.0	1.67	7.9	1.70	8.3	1.72	8.9	1.74	9.5	1.76	9.8	1.77
	10.0	7.0	1.78	7.9	1.81	8.3	1.83	8.9	1.85	9.5	1.87	9.8	1.88
	15.0	7.0	1.69	7.9	1.72	8.3	1.74	8.9	1.76	9.5	1.78	9.8	1.79
	20.0	7.0	1.60	7.9	1.63	8.3	1.64	8.9	1.66	9.5	1.68	9.8	1.69
	25.0	7.0	1.94	7.9	1.97	8.3	1.99	8.9	2.01	9.5	2.03	9.8	2.04
	30.0	7.0	2.32	7.9	2.36	8.3	2.38	8.9	2.41	9.5	2.44	9.8	2.45
	35.0	7.0	2.69	7.9	2.74	8.3	2.76	8.9	2.79	9.5	2.82	9.8	2.84
40.0	5.8	2.27	6.5	2.31	6.9	2.33	7.4	2.36	7.9	2.39	8.1	2.40	
46.0	5.8	1.86	6.5	1.89	6.9	1.91	7.4	1.93	7.9	1.95	8.1	1.96	

NOTES:

- TC: Total Capacity (kW), IP: Input Power (kW)
- Values mentioned in the table are based on the following conditions:
 - Power source of specifications: 230 V
 - Pipe length: 5 m, Height difference: 0 m (Outdoor unit—Indoor unit)
- 2 or more indoor units should be connected.
- The total ability of connected indoor unit is from 25,000 Btu/h up to 49,000 Btu/h.
- Input in the table are calculated based on the maximum indoor unit input combinations.

● Compact cassette type

Model: AUXG07KVLA

Outdoor temperature	Indoor temperature (°CDB / °CWB)											
	18.0 / 12.0		21.0 / 15.0		23.0 / 16.0		27.0 / 19.0		29.0 / 21.0		32.0 / 23.0	
(°CDB)	TC	SHC	TC	SHC	TC	SHC	TC	SHC	TC	SHC	TC	SHC
-10.0	1.96	1.32	2.22	1.51	2.34	1.74	2.50	1.95	2.67	2.13	2.76	2.44
-5.0	1.96	1.32	2.22	1.51	2.34	1.74	2.50	1.95	2.67	2.13	2.76	2.44
0.0	1.96	1.32	2.22	1.51	2.34	1.74	2.50	1.95	2.67	2.13	2.76	2.44
5.0	1.96	1.32	2.22	1.51	2.34	1.74	2.50	1.95	2.67	2.13	2.76	2.44
10.0	1.96	1.32	2.22	1.51	2.34	1.74	2.50	1.95	2.67	2.13	2.76	2.44
15.0	1.96	1.32	2.22	1.51	2.34	1.74	2.50	1.95	2.67	2.13	2.76	2.44
20.0	1.96	1.32	2.22	1.51	2.34	1.74	2.50	1.95	2.67	2.13	2.76	2.44
25.0	1.96	1.32	2.22	1.51	2.34	1.74	2.50	1.95	2.67	2.13	2.76	2.44
30.0	1.96	1.32	2.22	1.51	2.34	1.74	2.50	1.95	2.67	2.13	2.76	2.44
35.0	1.96	1.32	2.22	1.51	2.34	1.74	2.50	1.95	2.67	2.13	2.76	2.44
40.0	1.62	0.91	1.83	1.03	1.93	1.19	2.07	1.34	2.21	1.46	2.28	1.67
46.0	1.28	0.57	1.45	0.65	1.53	0.75	1.64	0.84	1.75	0.92	1.81	1.05

OUTDOOR UNIT
AOYG30KETA4OUTDOOR UNIT
AOYG30KETA4

Model: AUXG09KVLA

Outdoor temperature	Indoor temperature (°CDB / °CWB)											
	18.0 / 12.0		21.0 / 15.0		23.0 / 16.0		27.0 / 19.0		29.0 / 21.0		32.0 / 23.0	
(°CDB)	TC	SHC	TC	SHC	TC	SHC	TC	SHC	TC	SHC	TC	SHC
-10.0	2.51	1.67	2.84	1.90	2.99	2.19	3.20	2.46	3.42	2.69	3.53	3.09
-5.0	2.51	1.67	2.84	1.90	2.99	2.19	3.20	2.46	3.42	2.69	3.53	3.09
0.0	2.51	1.67	2.84	1.90	2.99	2.19	3.20	2.46	3.42	2.69	3.53	3.09
5.0	2.51	1.67	2.84	1.90	2.99	2.19	3.20	2.46	3.42	2.69	3.53	3.09
10.0	2.51	1.67	2.84	1.90	2.99	2.19	3.20	2.46	3.42	2.69	3.53	3.09
15.0	2.51	1.67	2.84	1.90	2.99	2.19	3.20	2.46	3.42	2.69	3.53	3.09
20.0	2.51	1.67	2.84	1.90	2.99	2.19	3.20	2.46	3.42	2.69	3.53	3.09
25.0	2.51	1.67	2.84	1.90	2.99	2.19	3.20	2.46	3.42	2.69	3.53	3.09
30.0	2.51	1.67	2.84	1.90	2.99	2.19	3.20	2.46	3.42	2.69	3.53	3.09
35.0	2.51	1.67	2.84	1.90	2.99	2.19	3.20	2.46	3.42	2.69	3.53	3.09
40.0	2.08	1.14	2.35	1.30	2.47	1.50	2.65	1.69	2.83	1.85	2.92	2.11
46.0	1.64	0.72	1.86	0.82	1.96	0.94	2.10	1.06	2.24	1.16	2.31	1.33

Model: AUXG12KVLA

Outdoor temperature	Indoor temperature (°CDB / °CWB)											
	18.0 / 12.0		21.0 / 15.0		23.0 / 16.0		27.0 / 19.0		29.0 / 21.0		32.0 / 23.0	
(°CDB)	TC	SHC	TC	SHC	TC	SHC	TC	SHC	TC	SHC	TC	SHC
-10.0	3.37	2.22	3.81	2.53	4.02	2.91	4.30	3.27	4.60	3.57	4.74	4.10
-5.0	3.37	2.22	3.81	2.53	4.02	2.91	4.30	3.27	4.60	3.57	4.74	4.10
0.0	3.37	2.22	3.81	2.53	4.02	2.91	4.30	3.27	4.60	3.57	4.74	4.10
5.0	3.37	2.22	3.81	2.53	4.02	2.91	4.30	3.27	4.60	3.57	4.74	4.10
10.0	3.37	2.22	3.81	2.53	4.02	2.91	4.30	3.27	4.60	3.57	4.74	4.10
15.0	3.37	2.22	3.81	2.53	4.02	2.91	4.30	3.27	4.60	3.57	4.74	4.10
20.0	3.37	2.22	3.81	2.53	4.02	2.91	4.30	3.27	4.60	3.57	4.74	4.10
25.0	3.37	2.22	3.81	2.53	4.02	2.91	4.30	3.27	4.60	3.57	4.74	4.10
30.0	3.37	2.22	3.81	2.53	4.02	2.91	4.30	3.27	4.60	3.57	4.74	4.10
35.0	3.37	2.22	3.81	2.53	4.02	2.91	4.30	3.27	4.60	3.57	4.74	4.10
40.0	2.79	1.52	3.15	1.73	3.32	1.99	3.56	2.24	3.80	2.45	3.92	2.81
46.0	2.21	0.95	2.50	1.08	2.63	1.25	2.82	1.40	3.01	1.53	3.11	1.76

Model: AUXG14KVLA

Outdoor temperature	Indoor temperature (°CDB / °CWB)											
	18.0 / 12.0		21.0 / 15.0		23.0 / 16.0		27.0 / 19.0		29.0 / 21.0		32.0 / 23.0	
(°CDB)	TC	SHC	TC	SHC	TC	SHC	TC	SHC	TC	SHC	TC	SHC
-10.0	3.92	2.44	4.43	2.78	4.67	3.20	5.00	3.60	5.35	3.94	5.51	4.51
-5.0	3.92	2.44	4.43	2.78	4.67	3.20	5.00	3.60	5.35	3.94	5.51	4.51
0.0	3.92	2.44	4.43	2.78	4.67	3.20	5.00	3.60	5.35	3.94	5.51	4.51
5.0	3.92	2.44	4.43	2.78	4.67	3.20	5.00	3.60	5.35	3.94	5.51	4.51
10.0	3.92	2.44	4.43	2.78	4.67	3.20	5.00	3.60	5.35	3.94	5.51	4.51
15.0	3.92	2.44	4.43	2.78	4.67	3.20	5.00	3.60	5.35	3.94	5.51	4.51
20.0	3.92	2.44	4.43	2.78	4.67	3.20	5.00	3.60	5.35	3.94	5.51	4.51
25.0	3.92	2.44	4.43	2.78	4.67	3.20	5.00	3.60	5.35	3.94	5.51	4.51
30.0	3.92	2.44	4.43	2.78	4.67	3.20	5.00	3.60	5.35	3.94	5.51	4.51
35.0	3.92	2.44	4.43	2.78	4.67	3.20	5.00	3.60	5.35	3.94	5.51	4.51
40.0	3.24	1.67	3.67	1.91	3.87	2.19	4.14	2.47	4.42	2.70	4.56	3.09
46.0	2.57	1.05	2.90	1.20	3.06	1.38	3.28	1.55	3.50	1.69	3.61	1.94

Model: AUXG18KVLA

Outdoor temperature	Indoor temperature (°CDB / °CWB)											
	18.0 / 12.0		21.0 / 15.0		23.0 / 16.0		27.0 / 19.0		29.0 / 21.0		32.0 / 23.0	
(°CDB)	TC	SHC	TC	SHC	TC	SHC	TC	SHC	TC	SHC	TC	SHC
-10.0	4.75	2.88	5.37	3.28	5.66	3.78	6.06	4.24	6.48	4.64	6.68	5.32
-5.0	4.75	2.88	5.37	3.28	5.66	3.78	6.06	4.24	6.48	4.64	6.68	5.32
0.0	4.75	2.88	5.37	3.28	5.66	3.78	6.06	4.24	6.48	4.64	6.68	5.32
5.0	4.75	2.88	5.37	3.28	5.66	3.78	6.06	4.24	6.48	4.64	6.68	5.32
10.0	4.75	2.88	5.37	3.28	5.66	3.78	6.06	4.24	6.48	4.64	6.68	5.32
15.0	4.75	2.88	5.37	3.28	5.66	3.78	6.06	4.24	6.48	4.64	6.68	5.32
20.0	4.75	2.88	5.37	3.28	5.66	3.78	6.06	4.24	6.48	4.64	6.68	5.32
25.0	4.75	2.88	5.37	3.28	5.66	3.78	6.06	4.24	6.48	4.64	6.68	5.32
30.0	4.75	2.88	5.37	3.28	5.66	3.78	6.06	4.24	6.48	4.64	6.68	5.32
35.0	4.75	2.88	5.37	3.28	5.66	3.78	6.06	4.24	6.48	4.64	6.68	5.32
40.0	3.93	1.97	4.44	2.25	4.68	2.59	5.02	2.91	5.36	3.18	5.53	3.64
46.0	3.11	1.24	3.52	1.41	3.71	1.62	3.97	1.82	4.25	1.99	4.38	2.28

Model: AUXG22KVLA

Outdoor temperature	Indoor temperature (°CDB / °CWB)											
	18.0 / 12.0		21.0 / 15.0		23.0 / 16.0		27.0 / 19.0		29.0 / 21.0		32.0 / 23.0	
(°CDB)	TC	SHC	TC	SHC	TC	SHC	TC	SHC	TC	SHC	TC	SHC
-10.0	6.01	3.65	6.79	4.16	7.15	4.80	7.66	5.39	8.19	5.89	8.44	6.75
-5.0	6.01	3.65	6.79	4.16	7.15	4.80	7.66	5.39	8.19	5.89	8.44	6.75
0.0	6.01	3.65	6.79	4.16	7.15	4.80	7.66	5.39	8.19	5.89	8.44	6.75
5.0	6.01	3.65	6.79	4.16	7.15	4.80	7.66	5.39	8.19	5.89	8.44	6.75
10.0	6.01	3.65	6.79	4.16	7.15	4.80	7.66	5.39	8.19	5.89	8.44	6.75
15.0	6.01	3.65	6.79	4.16	7.15	4.80	7.66	5.39	8.19	5.89	8.44	6.75
20.0	6.01	3.65	6.79	4.16	7.15	4.80	7.66	5.39	8.19	5.89	8.44	6.75
25.0	6.01	3.65	6.79	4.16	7.15	4.80	7.66	5.39	8.19	5.89	8.44	6.75
30.0	6.01	3.65	6.79	4.16	7.15	4.80	7.66	5.39	8.19	5.89	8.44	6.75
35.0	6.01	3.65	6.79	4.16	7.15	4.80	7.66	5.39	8.19	5.89	8.44	6.75
40.0	4.97	2.50	5.62	2.85	5.92	3.28	6.34	3.69	6.78	4.04	6.99	4.62
46.0	3.94	1.57	4.45	1.79	4.69	2.06	5.02	2.31	5.37	2.53	5.53	2.90

NOTES:

- TC: Total Capacity (kW), SHC: Sensible Heat Capacity (kW)
- Values mentioned in the table are based on the following conditions:
 - Pipe length: 5 m, Height difference: 0 m (Outdoor unit—Indoor unit)

● Mini duct type

Model: ARXG07KSLAP

Outdoor temperature	Indoor temperature (°CDB / °CWB)											
	18.0 / 12.0		21.0 / 15.0		23.0 / 16.0		27.0 / 19.0		29.0 / 21.0		32.0 / 23.0	
(°CDB)	TC	SHC	TC	SHC	TC	SHC	TC	SHC	TC	SHC	TC	SHC
-10.0	1.96	1.36	2.22	1.55	2.34	1.78	2.50	2.00	2.67	2.19	2.76	2.51
-5.0	1.96	1.36	2.22	1.55	2.34	1.78	2.50	2.00	2.67	2.19	2.76	2.51
0.0	1.96	1.36	2.22	1.55	2.34	1.78	2.50	2.00	2.67	2.19	2.76	2.51
5.0	1.96	1.36	2.22	1.55	2.34	1.78	2.50	2.00	2.67	2.19	2.76	2.51
10.0	1.96	1.36	2.22	1.55	2.34	1.78	2.50	2.00	2.67	2.19	2.76	2.51
15.0	1.96	1.36	2.22	1.55	2.34	1.78	2.50	2.00	2.67	2.19	2.76	2.51
20.0	1.96	1.36	2.22	1.55	2.34	1.78	2.50	2.00	2.67	2.19	2.76	2.51
25.0	1.96	1.36	2.22	1.55	2.34	1.78	2.50	2.00	2.67	2.19	2.76	2.51
30.0	1.96	1.36	2.22	1.55	2.34	1.78	2.50	2.00	2.67	2.19	2.76	2.51
35.0	1.96	1.36	2.22	1.55	2.34	1.78	2.50	2.00	2.67	2.19	2.76	2.51
40.0	1.62	0.93	1.83	1.06	1.93	1.22	2.07	1.37	2.21	1.50	2.28	1.72
46.0	1.28	0.58	1.45	0.66	1.53	0.76	1.64	0.86	1.75	0.94	1.81	1.08

OUTDOOR UNIT
AOYG30KBTA4OUTDOOR UNIT
AOYG30KBTA4

Model: ARXG09KSLAP

Outdoor temperature	Indoor temperature (°CDB / °CWB)											
	18.0 / 12.0		21.0 / 15.0		23.0 / 16.0		27.0 / 19.0		29.0 / 21.0		32.0 / 23.0	
(°CDB)	TC	SHC	TC	SHC	TC	SHC	TC	SHC	TC	SHC	TC	SHC
-10.0	2.51	1.61	2.84	1.83	2.99	2.11	3.20	2.37	3.42	2.59	3.53	2.97
-5.0	2.51	1.61	2.84	1.83	2.99	2.11	3.20	2.37	3.42	2.59	3.53	2.97
0.0	2.51	1.61	2.84	1.83	2.99	2.11	3.20	2.37	3.42	2.59	3.53	2.97
5.0	2.51	1.61	2.84	1.83	2.99	2.11	3.20	2.37	3.42	2.59	3.53	2.97
10.0	2.51	1.61	2.84	1.83	2.99	2.11	3.20	2.37	3.42	2.59	3.53	2.97
15.0	2.51	1.61	2.84	1.83	2.99	2.11	3.20	2.37	3.42	2.59	3.53	2.97
20.0	2.51	1.61	2.84	1.83	2.99	2.11	3.20	2.37	3.42	2.59	3.53	2.97
25.0	2.51	1.61	2.84	1.83	2.99	2.11	3.20	2.37	3.42	2.59	3.53	2.97
30.0	2.51	1.61	2.84	1.83	2.99	2.11	3.20	2.37	3.42	2.59	3.53	2.97
35.0	2.51	1.61	2.84	1.83	2.99	2.11	3.20	2.37	3.42	2.59	3.53	2.97
40.0	2.08	1.10	2.35	1.25	2.47	1.44	2.65	1.62	2.83	1.77	2.92	2.03
46.0	1.64	0.69	1.86	0.79	1.96	0.91	2.10	1.02	2.24	1.11	2.31	1.27

Model: ARXG12KSLAP

Outdoor temperature	Indoor temperature (°CDB / °CWB)											
	18.0 / 12.0		21.0 / 15.0		23.0 / 16.0		27.0 / 19.0		29.0 / 21.0		32.0 / 23.0	
(°CDB)	TC	SHC	TC	SHC	TC	SHC	TC	SHC	TC	SHC	TC	SHC
-10.0	3.37	2.16	3.81	2.46	4.02	2.83	4.30	3.18	4.60	3.48	4.74	3.99
-5.0	3.37	2.16	3.81	2.46	4.02	2.83	4.30	3.18	4.60	3.48	4.74	3.99
0.0	3.37	2.16	3.81	2.46	4.02	2.83	4.30	3.18	4.60	3.48	4.74	3.99
5.0	3.37	2.16	3.81	2.46	4.02	2.83	4.30	3.18	4.60	3.48	4.74	3.99
10.0	3.37	2.16	3.81	2.46	4.02	2.83	4.30	3.18	4.60	3.48	4.74	3.99
15.0	3.37	2.16	3.81	2.46	4.02	2.83	4.30	3.18	4.60	3.48	4.74	3.99
20.0	3.37	2.16	3.81	2.46	4.02	2.83	4.30	3.18	4.60	3.48	4.74	3.99
25.0	3.37	2.16	3.81	2.46	4.02	2.83	4.30	3.18	4.60	3.48	4.74	3.99
30.0	3.37	2.16	3.81	2.46	4.02	2.83	4.30	3.18	4.60	3.48	4.74	3.99
35.0	3.37	2.16	3.81	2.46	4.02	2.83	4.30	3.18	4.60	3.48	4.74	3.99
40.0	2.79	1.48	3.15	1.69	3.32	1.94	3.56	2.18	3.80	2.38	3.92	2.73
46.0	2.21	0.93	2.50	1.06	2.63	1.22	2.82	1.37	3.01	1.49	3.11	1.71

Model: ARXG14KSLAP

Outdoor temperature	Indoor temperature (°CDB / °CWB)											
	18.0 / 12.0		21.0 / 15.0		23.0 / 16.0		27.0 / 19.0		29.0 / 21.0		32.0 / 23.0	
(°CDB)	TC	SHC	TC	SHC	TC	SHC	TC	SHC	TC	SHC	TC	SHC
-10.0	3.92	2.41	4.43	2.74	4.67	3.16	5.00	3.55	5.35	3.88	5.51	4.45
-5.0	3.92	2.41	4.43	2.74	4.67	3.16	5.00	3.55	5.35	3.88	5.51	4.45
0.0	3.92	2.41	4.43	2.74	4.67	3.16	5.00	3.55	5.35	3.88	5.51	4.45
5.0	3.92	2.41	4.43	2.74	4.67	3.16	5.00	3.55	5.35	3.88	5.51	4.45
10.0	3.92	2.41	4.43	2.74	4.67	3.16	5.00	3.55	5.35	3.88	5.51	4.45
15.0	3.92	2.41	4.43	2.74	4.67	3.16	5.00	3.55	5.35	3.88	5.51	4.45
20.0	3.92	2.41	4.43	2.74	4.67	3.16	5.00	3.55	5.35	3.88	5.51	4.45
25.0	3.92	2.41	4.43	2.74	4.67	3.16	5.00	3.55	5.35	3.88	5.51	4.45
30.0	3.92	2.41	4.43	2.74	4.67	3.16	5.00	3.55	5.35	3.88	5.51	4.45
35.0	3.92	2.41	4.43	2.74	4.67	3.16	5.00	3.55	5.35	3.88	5.51	4.45
40.0	3.24	1.65	3.67	1.88	3.87	2.16	4.14	2.43	4.42	2.66	4.56	3.05
46.0	2.57	1.03	2.90	1.18	3.06	1.36	3.28	1.52	3.50	1.67	3.61	1.91

Model: ARXG18KSLAP

Outdoor temperature (°CDB)	Indoor temperature (°CDB / °CWB)											
	18.0 / 12.0		21.0 / 15.0		23.0 / 16.0		27.0 / 19.0		29.0 / 21.0		32.0 / 23.0	
	TC	SHC	TC	SHC	TC	SHC	TC	SHC	TC	SHC	TC	SHC
-10.0	4.75	2.96	5.37	3.37	5.66	3.88	6.06	4.36	6.48	4.77	6.68	5.47
-5.0	4.75	2.96	5.37	3.37	5.66	3.88	6.06	4.36	6.48	4.77	6.68	5.47
0.0	4.75	2.96	5.37	3.37	5.66	3.88	6.06	4.36	6.48	4.77	6.68	5.47
5.0	4.75	2.96	5.37	3.37	5.66	3.88	6.06	4.36	6.48	4.77	6.68	5.47
10.0	4.75	2.96	5.37	3.37	5.66	3.88	6.06	4.36	6.48	4.77	6.68	5.47
15.0	4.75	2.96	5.37	3.37	5.66	3.88	6.06	4.36	6.48	4.77	6.68	5.47
20.0	4.75	2.96	5.37	3.37	5.66	3.88	6.06	4.36	6.48	4.77	6.68	5.47
25.0	4.75	2.96	5.37	3.37	5.66	3.88	6.06	4.36	6.48	4.77	6.68	5.47
30.0	4.75	2.96	5.37	3.37	5.66	3.88	6.06	4.36	6.48	4.77	6.68	5.47
35.0	4.75	2.96	5.37	3.37	5.66	3.88	6.06	4.36	6.48	4.77	6.68	5.47
40.0	3.93	2.03	4.44	2.31	4.68	2.66	5.02	2.99	5.36	3.27	5.53	3.75
46.0	3.11	1.27	3.52	1.45	3.71	1.67	3.97	1.87	4.25	2.05	4.38	2.35

NOTES:

- TC: Total Capacity (kW), SHC: Sensible Heat Capacity (kW)
- Values mentioned in the table are based on the following conditions:
 - Pipe length: 5 m, Height difference: 0 m [Outdoor unit—Indoor unit]

● Slim duct type

Model: ARXG07KLLAP

Outdoor temperature	Indoor temperature (°CDB / °CWB)											
	18.0 / 12.0		21.0 / 15.0		23.0 / 16.0		27.0 / 19.0		29.0 / 21.0		32.0 / 23.0	
(°CDB)	TC	SHC	TC	SHC	TC	SHC	TC	SHC	TC	SHC	TC	SHC
-10.0	1.96	1.36	2.22	1.55	2.34	1.78	2.50	2.00	2.67	2.19	2.76	2.51
-5.0	1.96	1.36	2.22	1.55	2.34	1.78	2.50	2.00	2.67	2.19	2.76	2.51
0.0	1.96	1.36	2.22	1.55	2.34	1.78	2.50	2.00	2.67	2.19	2.76	2.51
5.0	1.96	1.36	2.22	1.55	2.34	1.78	2.50	2.00	2.67	2.19	2.76	2.51
10.0	1.96	1.36	2.22	1.55	2.34	1.78	2.50	2.00	2.67	2.19	2.76	2.51
15.0	1.96	1.36	2.22	1.55	2.34	1.78	2.50	2.00	2.67	2.19	2.76	2.51
20.0	1.96	1.36	2.22	1.55	2.34	1.78	2.50	2.00	2.67	2.19	2.76	2.51
25.0	1.96	1.36	2.22	1.55	2.34	1.78	2.50	2.00	2.67	2.19	2.76	2.51
30.0	1.96	1.36	2.22	1.55	2.34	1.78	2.50	2.00	2.67	2.19	2.76	2.51
35.0	1.96	1.36	2.22	1.55	2.34	1.78	2.50	2.00	2.67	2.19	2.76	2.51
40.0	1.62	0.93	1.83	1.06	1.93	1.22	2.07	1.37	2.21	1.50	2.28	1.72
46.0	1.28	0.58	1.45	0.66	1.53	0.76	1.64	0.86	1.75	0.94	1.81	1.08

OUTDOOR UNIT
AOYG30KBTA4OUTDOOR UNIT
AOYG30KBTA4

Model: ARXG09KLLAP

Outdoor temperature	Indoor temperature (°CDB / °CWB)											
	18.0 / 12.0		21.0 / 15.0		23.0 / 16.0		27.0 / 19.0		29.0 / 21.0		32.0 / 23.0	
(°CDB)	TC	SHC	TC	SHC	TC	SHC	TC	SHC	TC	SHC	TC	SHC
-10.0	2.51	1.67	2.84	1.90	2.99	2.19	3.20	2.46	3.42	2.69	3.53	3.09
-5.0	2.51	1.67	2.84	1.90	2.99	2.19	3.20	2.46	3.42	2.69	3.53	3.09
0.0	2.51	1.67	2.84	1.90	2.99	2.19	3.20	2.46	3.42	2.69	3.53	3.09
5.0	2.51	1.67	2.84	1.90	2.99	2.19	3.20	2.46	3.42	2.69	3.53	3.09
10.0	2.51	1.67	2.84	1.90	2.99	2.19	3.20	2.46	3.42	2.69	3.53	3.09
15.0	2.51	1.67	2.84	1.90	2.99	2.19	3.20	2.46	3.42	2.69	3.53	3.09
20.0	2.51	1.67	2.84	1.90	2.99	2.19	3.20	2.46	3.42	2.69	3.53	3.09
25.0	2.51	1.67	2.84	1.90	2.99	2.19	3.20	2.46	3.42	2.69	3.53	3.09
30.0	2.51	1.67	2.84	1.90	2.99	2.19	3.20	2.46	3.42	2.69	3.53	3.09
35.0	2.51	1.67	2.84	1.90	2.99	2.19	3.20	2.46	3.42	2.69	3.53	3.09
40.0	2.08	1.14	2.35	1.30	2.47	1.50	2.65	1.69	2.83	1.85	2.92	2.11
46.0	1.64	0.72	1.86	0.82	1.96	0.94	2.10	1.06	2.24	1.16	2.31	1.33

Model: ARXG12KLLAP

Outdoor temperature	Indoor temperature (°CDB / °CWB)											
	18.0 / 12.0		21.0 / 15.0		23.0 / 16.0		27.0 / 19.0		29.0 / 21.0		32.0 / 23.0	
(°CDB)	TC	SHC	TC	SHC	TC	SHC	TC	SHC	TC	SHC	TC	SHC
-10.0	3.37	2.27	3.81	2.59	4.02	2.99	4.30	3.35	4.60	3.67	4.74	4.20
-5.0	3.37	2.27	3.81	2.59	4.02	2.99	4.30	3.35	4.60	3.67	4.74	4.20
0.0	3.37	2.27	3.81	2.59	4.02	2.99	4.30	3.35	4.60	3.67	4.74	4.20
5.0	3.37	2.27	3.81	2.59	4.02	2.99	4.30	3.35	4.60	3.67	4.74	4.20
10.0	3.37	2.27	3.81	2.59	4.02	2.99	4.30	3.35	4.60	3.67	4.74	4.20
15.0	3.37	2.27	3.81	2.59	4.02	2.99	4.30	3.35	4.60	3.67	4.74	4.20
20.0	3.37	2.27	3.81	2.59	4.02	2.99	4.30	3.35	4.60	3.67	4.74	4.20
25.0	3.37	2.27	3.81	2.59	4.02	2.99	4.30	3.35	4.60	3.67	4.74	4.20
30.0	3.37	2.27	3.81	2.59	4.02	2.99	4.30	3.35	4.60	3.67	4.74	4.20
35.0	3.37	2.27	3.81	2.59	4.02	2.99	4.30	3.35	4.60	3.67	4.74	4.20
40.0	2.79	1.56	3.15	1.78	3.32	2.04	3.56	2.30	3.80	2.51	3.92	2.88
46.0	2.21	0.98	2.50	1.11	2.63	1.28	2.82	1.44	3.01	1.58	3.11	1.80

Model: ARXG14KLLAP

Outdoor temperature	Indoor temperature (°CDB / °CWB)											
	18.0 / 12.0		21.0 / 15.0		23.0 / 16.0		27.0 / 19.0		29.0 / 21.0		32.0 / 23.0	
(°CDB)	TC	SHC	TC	SHC	TC	SHC	TC	SHC	TC	SHC	TC	SHC
-10.0	3.92	2.51	4.43	2.86	4.67	3.29	5.00	3.70	5.35	4.05	5.51	4.64
-5.0	3.92	2.51	4.43	2.86	4.67	3.29	5.00	3.70	5.35	4.05	5.51	4.64
0.0	3.92	2.51	4.43	2.86	4.67	3.29	5.00	3.70	5.35	4.05	5.51	4.64
5.0	3.92	2.51	4.43	2.86	4.67	3.29	5.00	3.70	5.35	4.05	5.51	4.64
10.0	3.92	2.51	4.43	2.86	4.67	3.29	5.00	3.70	5.35	4.05	5.51	4.64
15.0	3.92	2.51	4.43	2.86	4.67	3.29	5.00	3.70	5.35	4.05	5.51	4.64
20.0	3.92	2.51	4.43	2.86	4.67	3.29	5.00	3.70	5.35	4.05	5.51	4.64
25.0	3.92	2.51	4.43	2.86	4.67	3.29	5.00	3.70	5.35	4.05	5.51	4.64
30.0	3.92	2.51	4.43	2.86	4.67	3.29	5.00	3.70	5.35	4.05	5.51	4.64
35.0	3.92	2.51	4.43	2.86	4.67	3.29	5.00	3.70	5.35	4.05	5.51	4.64
40.0	3.24	1.72	3.67	1.96	3.87	2.26	4.14	2.53	4.42	2.77	4.56	3.18
46.0	2.57	1.08	2.90	1.23	3.06	1.41	3.28	1.59	3.50	1.74	3.61	1.99

Model: ARXG18KLLAP

Outdoor temperature	Indoor temperature (°CDB / °CWB)											
	18.0 / 12.0		21.0 / 15.0		23.0 / 16.0		27.0 / 19.0		29.0 / 21.0		32.0 / 23.0	
(°CDB)	TC	SHC	TC	SHC	TC	SHC	TC	SHC	TC	SHC	TC	SHC
-10.0	4.75	2.96	5.37	3.37	5.66	3.88	6.06	4.36	6.48	4.77	6.68	5.47
-5.0	4.75	2.96	5.37	3.37	5.66	3.88	6.06	4.36	6.48	4.77	6.68	5.47
0.0	4.75	2.96	5.37	3.37	5.66	3.88	6.06	4.36	6.48	4.77	6.68	5.47
5.0	4.75	2.96	5.37	3.37	5.66	3.88	6.06	4.36	6.48	4.77	6.68	5.47
10.0	4.75	2.96	5.37	3.37	5.66	3.88	6.06	4.36	6.48	4.77	6.68	5.47
15.0	4.75	2.96	5.37	3.37	5.66	3.88	6.06	4.36	6.48	4.77	6.68	5.47
20.0	4.75	2.96	5.37	3.37	5.66	3.88	6.06	4.36	6.48	4.77	6.68	5.47
25.0	4.75	2.96	5.37	3.37	5.66	3.88	6.06	4.36	6.48	4.77	6.68	5.47
30.0	4.75	2.96	5.37	3.37	5.66	3.88	6.06	4.36	6.48	4.77	6.68	5.47
35.0	4.75	2.96	5.37	3.37	5.66	3.88	6.06	4.36	6.48	4.77	6.68	5.47
40.0	3.93	2.03	4.44	2.31	4.68	2.66	5.02	2.99	5.36	3.27	5.53	3.75
46.0	3.11	1.27	3.52	1.45	3.71	1.67	3.97	1.87	4.25	2.05	4.38	2.35

NOTES:

- TC: Total Capacity (kW), SHC: Sensible Heat Capacity (kW)
- Values mentioned in the table are based on the following conditions:
 - Pipe length: 5 m, Height difference: 0 m (Outdoor unit—Indoor unit)

● Medium static pressure duct type

Model: ARXG22KMLB

Outdoor temperature	Indoor temperature (°CDB / °CWB)											
	18.0 / 12.0		21.0 / 15.0		23.0 / 16.0		27.0 / 19.0		29.0 / 21.0		32.0 / 23.0	
(°CDB)	TC	SHC	TC	SHC	TC	SHC	TC	SHC	TC	SHC	TC	SHC
-10.0	6.01	3.96	6.79	4.51	7.15	5.19	7.66	5.83	8.19	6.38	8.44	7.31
-5.0	6.01	3.96	6.79	4.51	7.15	5.19	7.66	5.83	8.19	6.38	8.44	7.31
0.0	6.01	3.96	6.79	4.51	7.15	5.19	7.66	5.83	8.19	6.38	8.44	7.31
5.0	6.01	3.96	6.79	4.51	7.15	5.19	7.66	5.83	8.19	6.38	8.44	7.31
10.0	6.01	3.96	6.79	4.51	7.15	5.19	7.66	5.83	8.19	6.38	8.44	7.31
15.0	6.01	3.96	6.79	4.51	7.15	5.19	7.66	5.83	8.19	6.38	8.44	7.31
20.0	6.01	3.96	6.79	4.51	7.15	5.19	7.66	5.83	8.19	6.38	8.44	7.31
25.0	6.01	3.96	6.79	4.51	7.15	5.19	7.66	5.83	8.19	6.38	8.44	7.31
30.0	6.01	3.96	6.79	4.51	7.15	5.19	7.66	5.83	8.19	6.38	8.44	7.31
35.0	6.01	3.96	6.79	4.51	7.15	5.19	7.66	5.83	8.19	6.38	8.44	7.31
40.0	4.97	2.71	5.62	3.09	5.92	3.56	6.34	4.00	6.78	4.37	6.99	5.01
46.0	3.94	1.70	4.45	1.94	4.69	2.23	5.02	2.51	5.37	2.74	5.53	3.14

NOTES:

- TC: Total Capacity (kW), SHC: Sensible Heat Capacity (kW).
- Values mentioned in the table are based on the following conditions:
 - Pipe length: 5 m, Height difference: 0 m (Outdoor unit—Indoor unit)

● Wall mounted type

Model: ASYG07KGTB

Outdoor temperature	Indoor temperature (°CDB / °CWB)											
	18.0 / 12.0		21.0 / 15.0		23.0 / 16.0		27.0 / 19.0		29.0 / 21.0		32.0 / 23.0	
(°CDB)	TC	SHC	TC	SHC	TC	SHC	TC	SHC	TC	SHC	TC	SHC
-10.0	1.96	1.10	2.22	1.26	2.34	1.45	2.50	1.63	2.67	1.78	2.76	2.04
-5.0	1.96	1.10	2.22	1.26	2.34	1.45	2.50	1.63	2.67	1.78	2.76	2.04
0.0	1.96	1.10	2.22	1.26	2.34	1.45	2.50	1.63	2.67	1.78	2.76	2.04
5.0	1.96	1.10	2.22	1.26	2.34	1.45	2.50	1.63	2.67	1.78	2.76	2.04
10.0	1.96	1.10	2.22	1.26	2.34	1.45	2.50	1.63	2.67	1.78	2.76	2.04
15.0	1.96	1.10	2.22	1.26	2.34	1.45	2.50	1.63	2.67	1.78	2.76	2.04
20.0	1.96	1.10	2.22	1.26	2.34	1.45	2.50	1.63	2.67	1.78	2.76	2.04
25.0	1.96	1.10	2.22	1.26	2.34	1.45	2.50	1.63	2.67	1.78	2.76	2.04
30.0	1.96	1.10	2.22	1.26	2.34	1.45	2.50	1.63	2.67	1.78	2.76	2.04
35.0	1.96	1.10	2.22	1.26	2.34	1.45	2.50	1.63	2.67	1.78	2.76	2.04
40.0	1.62	0.75	1.83	0.86	1.93	0.99	2.07	1.11	2.21	1.22	2.28	1.39
46.0	1.28	0.47	1.45	0.54	1.53	0.62	1.64	0.70	1.75	0.76	1.81	0.87

Model: ASYG09KGTB

Outdoor temperature	Indoor temperature (°CDB / °CWB)											
	18.0 / 12.0		21.0 / 15.0		23.0 / 16.0		27.0 / 19.0		29.0 / 21.0		32.0 / 23.0	
(°CDB)	TC	SHC	TC	SHC	TC	SHC	TC	SHC	TC	SHC	TC	SHC
-10.0	2.51	1.41	2.84	1.61	2.99	1.85	3.20	2.08	3.42	2.27	3.53	2.61
-5.0	2.51	1.41	2.84	1.61	2.99	1.85	3.20	2.08	3.42	2.27	3.53	2.61
0.0	2.51	1.41	2.84	1.61	2.99	1.85	3.20	2.08	3.42	2.27	3.53	2.61
5.0	2.51	1.41	2.84	1.61	2.99	1.85	3.20	2.08	3.42	2.27	3.53	2.61
10.0	2.51	1.41	2.84	1.61	2.99	1.85	3.20	2.08	3.42	2.27	3.53	2.61
15.0	2.51	1.41	2.84	1.61	2.99	1.85	3.20	2.08	3.42	2.27	3.53	2.61
20.0	2.51	1.41	2.84	1.61	2.99	1.85	3.20	2.08	3.42	2.27	3.53	2.61
25.0	2.51	1.41	2.84	1.61	2.99	1.85	3.20	2.08	3.42	2.27	3.53	2.61
30.0	2.51	1.41	2.84	1.61	2.99	1.85	3.20	2.08	3.42	2.27	3.53	2.61
35.0	2.51	1.41	2.84	1.61	2.99	1.85	3.20	2.08	3.42	2.27	3.53	2.61
40.0	2.08	0.97	2.35	1.10	2.47	1.27	2.65	1.42	2.83	1.56	2.92	1.79
46.0	1.64	0.61	1.86	0.69	1.96	0.79	2.10	0.89	2.24	0.98	2.31	1.12

Model: ASYG12KGTB

Outdoor temperature	Indoor temperature (°CDB / °CWB)											
	18.0 / 12.0		21.0 / 15.0		23.0 / 16.0		27.0 / 19.0		29.0 / 21.0		32.0 / 23.0	
(°CDB)	TC	SHC	TC	SHC	TC	SHC	TC	SHC	TC	SHC	TC	SHC
-10.0	3.37	1.90	3.81	2.16	4.02	2.49	4.30	2.80	4.60	3.06	4.74	3.50
-5.0	3.37	1.90	3.81	2.16	4.02	2.49	4.30	2.80	4.60	3.06	4.74	3.50
0.0	3.37	1.90	3.81	2.16	4.02	2.49	4.30	2.80	4.60	3.06	4.74	3.50
5.0	3.37	1.90	3.81	2.16	4.02	2.49	4.30	2.80	4.60	3.06	4.74	3.50
10.0	3.37	1.90	3.81	2.16	4.02	2.49	4.30	2.80	4.60	3.06	4.74	3.50
15.0	3.37	1.90	3.81	2.16	4.02	2.49	4.30	2.80	4.60	3.06	4.74	3.50
20.0	3.37	1.90	3.81	2.16	4.02	2.49	4.30	2.80	4.60	3.06	4.74	3.50
25.0	3.37	1.90	3.81	2.16	4.02	2.49	4.30	2.80	4.60	3.06	4.74	3.50
30.0	3.37	1.90	3.81	2.16	4.02	2.49	4.30	2.80	4.60	3.06	4.74	3.50
35.0	3.37	1.90	3.81	2.16	4.02	2.49	4.30	2.80	4.60	3.06	4.74	3.50
40.0	2.79	1.30	3.15	1.48	3.32	1.70	3.56	1.91	3.80	2.09	3.92	2.40
46.0	2.21	0.81	2.50	0.93	2.63	1.07	2.82	1.20	3.01	1.31	3.11	1.50

Model: ASYG14KGTB

Outdoor temperature	Indoor temperature (°CDB / °CWB)											
	18.0 / 12.0		21.0 / 15.0		23.0 / 16.0		27.0 / 19.0		29.0 / 21.0		32.0 / 23.0	
(°CDB)	TC	SHC	TC	SHC	TC	SHC	TC	SHC	TC	SHC	TC	SHC
-10.0	3.92	2.20	4.43	2.51	4.67	2.89	5.00	3.25	5.35	3.55	5.51	4.07
-5.0	3.92	2.20	4.43	2.51	4.67	2.89	5.00	3.25	5.35	3.55	5.51	4.07
0.0	3.92	2.20	4.43	2.51	4.67	2.89	5.00	3.25	5.35	3.55	5.51	4.07
5.0	3.92	2.20	4.43	2.51	4.67	2.89	5.00	3.25	5.35	3.55	5.51	4.07
10.0	3.92	2.20	4.43	2.51	4.67	2.89	5.00	3.25	5.35	3.55	5.51	4.07
15.0	3.92	2.20	4.43	2.51	4.67	2.89	5.00	3.25	5.35	3.55	5.51	4.07
20.0	3.92	2.20	4.43	2.51	4.67	2.89	5.00	3.25	5.35	3.55	5.51	4.07
25.0	3.92	2.20	4.43	2.51	4.67	2.89	5.00	3.25	5.35	3.55	5.51	4.07
30.0	3.92	2.20	4.43	2.51	4.67	2.89	5.00	3.25	5.35	3.55	5.51	4.07
35.0	3.92	2.20	4.43	2.51	4.67	2.89	5.00	3.25	5.35	3.55	5.51	4.07
40.0	3.24	1.51	3.67	1.72	3.87	1.98	4.14	2.23	4.42	2.43	4.56	2.79
46.0	2.57	0.95	2.90	1.08	3.06	1.24	3.28	1.40	3.50	1.53	3.61	1.75

Model: ASYG18KMTB

Outdoor temperature	Indoor temperature (°CDB / °CWB)											
	18.0 / 12.0		21.0 / 15.0		23.0 / 16.0		27.0 / 19.0		29.0 / 21.0		32.0 / 23.0	
(°CDB)	TC	SHC	TC	SHC	TC	SHC	TC	SHC	TC	SHC	TC	SHC
-10.0	4.75	3.21	5.37	3.65	5.66	4.21	6.06	4.73	6.48	5.17	6.68	5.92
-5.0	4.75	3.21	5.37	3.65	5.66	4.21	6.06	4.73	6.48	5.17	6.68	5.92
0.0	4.75	3.21	5.37	3.65	5.66	4.21	6.06	4.73	6.48	5.17	6.68	5.92
5.0	4.75	3.21	5.37	3.65	5.66	4.21	6.06	4.73	6.48	5.17	6.68	5.92
10.0	4.75	3.21	5.37	3.65	5.66	4.21	6.06	4.73	6.48	5.17	6.68	5.92
15.0	4.75	3.21	5.37	3.65	5.66	4.21	6.06	4.73	6.48	5.17	6.68	5.92
20.0	4.75	3.21	5.37	3.65	5.66	4.21	6.06	4.73	6.48	5.17	6.68	5.92
25.0	4.75	3.21	5.37	3.65	5.66	4.21	6.06	4.73	6.48	5.17	6.68	5.92
30.0	4.75	3.21	5.37	3.65	5.66	4.21	6.06	4.73	6.48	5.17	6.68	5.92
35.0	4.75	3.21	5.37	3.65	5.66	4.21	6.06	4.73	6.48	5.17	6.68	5.92
40.0	3.93	2.20	4.44	2.50	4.68	2.88	5.02	3.24	5.36	3.54	5.53	4.06
46.0	3.11	1.38	3.52	1.57	3.71	1.81	3.97	2.03	4.25	2.22	4.38	2.54

OUTDOOR UNIT
AOYG30KETA4OUTDOOR UNIT
AOYG30KETA4

Model: ASYG22KMTB

Outdoor temperature	Indoor temperature (°CDB / °CWB)											
	18.0 / 12.0		21.0 / 15.0		23.0 / 16.0		27.0 / 19.0		29.0 / 21.0		32.0 / 23.0	
(°CDB)	TC	SHC	TC	SHC	TC	SHC	TC	SHC	TC	SHC	TC	SHC
-10.0	6.01	3.86	6.79	4.40	7.15	5.07	7.66	5.69	8.19	6.23	8.44	7.13
-5.0	6.01	3.86	6.79	4.40	7.15	5.07	7.66	5.69	8.19	6.23	8.44	7.13
0.0	6.01	3.86	6.79	4.40	7.15	5.07	7.66	5.69	8.19	6.23	8.44	7.13
5.0	6.01	3.86	6.79	4.40	7.15	5.07	7.66	5.69	8.19	6.23	8.44	7.13
10.0	6.01	3.86	6.79	4.40	7.15	5.07	7.66	5.69	8.19	6.23	8.44	7.13
15.0	6.01	3.86	6.79	4.40	7.15	5.07	7.66	5.69	8.19	6.23	8.44	7.13
20.0	6.01	3.86	6.79	4.40	7.15	5.07	7.66	5.69	8.19	6.23	8.44	7.13
25.0	6.01	3.86	6.79	4.40	7.15	5.07	7.66	5.69	8.19	6.23	8.44	7.13
30.0	6.01	3.86	6.79	4.40	7.15	5.07	7.66	5.69	8.19	6.23	8.44	7.13
35.0	6.01	3.86	6.79	4.40	7.15	5.07	7.66	5.69	8.19	6.23	8.44	7.13
40.0	4.97	2.64	5.62	3.02	5.92	3.47	6.34	3.90	6.78	4.27	6.99	4.89
46.0	3.94	1.66	4.45	1.89	4.69	2.18	5.02	2.44	5.37	2.67	5.53	3.06

Model: ASYG24KMTB

Outdoor temperature	Indoor temperature (°CDB / °CWB)											
	18.0 / 12.0		21.0 / 15.0		23.0 / 16.0		27.0 / 19.0		29.0 / 21.0		32.0 / 23.0	
(°CDB)	TC	SHC	TC	SHC	TC	SHC	TC	SHC	TC	SHC	TC	SHC
-10.0	6.13	3.96	6.93	4.51	7.30	5.20	7.82	5.84	8.36	6.38	8.62	7.31
-5.0	6.13	3.96	6.93	4.51	7.30	5.20	7.82	5.84	8.36	6.38	8.62	7.31
0.0	6.13	3.96	6.93	4.51	7.30	5.20	7.82	5.84	8.36	6.38	8.62	7.31
5.0	6.13	3.96	6.93	4.51	7.30	5.20	7.82	5.84	8.36	6.38	8.62	7.31
10.0	6.13	3.96	6.93	4.51	7.30	5.20	7.82	5.84	8.36	6.38	8.62	7.31
15.0	6.13	3.96	6.93	4.51	7.30	5.20	7.82	5.84	8.36	6.38	8.62	7.31
20.0	6.13	3.96	6.93	4.51	7.30	5.20	7.82	5.84	8.36	6.38	8.62	7.31
25.0	6.13	3.96	6.93	4.51	7.30	5.20	7.82	5.84	8.36	6.38	8.62	7.31
30.0	6.13	3.96	6.93	4.51	7.30	5.20	7.82	5.84	8.36	6.38	8.62	7.31
35.0	6.13	3.96	6.93	4.51	7.30	5.20	7.82	5.84	8.36	6.38	8.62	7.31
40.0	5.07	2.71	5.73	3.09	6.05	3.56	6.47	4.00	6.92	4.37	7.13	5.01
46.0	4.02	1.70	4.54	1.94	4.79	2.23	5.12	2.51	5.48	2.74	5.65	3.14

Model: ASYG07KMTB

Outdoor temperature	Indoor temperature (°CDB / °CWB)											
	18.0 / 12.0		21.0 / 15.0		23.0 / 16.0		27.0 / 19.0		29.0 / 21.0		32.0 / 23.0	
(°CDB)	TC	SHC	TC	SHC	TC	SHC	TC	SHC	TC	SHC	TC	SHC
-10.0	1.96	1.10	2.22	1.26	2.34	1.45	2.50	1.63	2.67	1.78	2.76	2.04
-5.0	1.96	1.10	2.22	1.26	2.34	1.45	2.50	1.63	2.67	1.78	2.76	2.04
0.0	1.96	1.10	2.22	1.26	2.34	1.45	2.50	1.63	2.67	1.78	2.76	2.04
5.0	1.96	1.10	2.22	1.26	2.34	1.45	2.50	1.63	2.67	1.78	2.76	2.04
10.0	1.96	1.10	2.22	1.26	2.34	1.45	2.50	1.63	2.67	1.78	2.76	2.04
15.0	1.96	1.10	2.22	1.26	2.34	1.45	2.50	1.63	2.67	1.78	2.76	2.04
20.0	1.96	1.10	2.22	1.26	2.34	1.45	2.50	1.63	2.67	1.78	2.76	2.04
25.0	1.96	1.10	2.22	1.26	2.34	1.45	2.50	1.63	2.67	1.78	2.76	2.04
30.0	1.96	1.10	2.22	1.26	2.34	1.45	2.50	1.63	2.67	1.78	2.76	2.04
35.0	1.96	1.10	2.22	1.26	2.34	1.45	2.50	1.63	2.67	1.78	2.76	2.04
40.0	1.62	0.75	1.83	0.86	1.93	0.99	2.07	1.11	2.21	1.22	2.28	1.39
46.0	1.28	0.47	1.45	0.54	1.53	0.62	1.64	0.70	1.75	0.76	1.81	0.87

Model: ASYG09KMTB

Outdoor temperature	Indoor temperature (°CDB / °CWB)											
	18.0 / 12.0		21.0 / 15.0		23.0 / 16.0		27.0 / 19.0		29.0 / 21.0		32.0 / 23.0	
(°CDB)	TC	SHC	TC	SHC	TC	SHC	TC	SHC	TC	SHC	TC	SHC
-10.0	2.51	1.41	2.84	1.61	2.99	1.85	3.20	2.08	3.42	2.27	3.53	2.61
-5.0	2.51	1.41	2.84	1.61	2.99	1.85	3.20	2.08	3.42	2.27	3.53	2.61
0.0	2.51	1.41	2.84	1.61	2.99	1.85	3.20	2.08	3.42	2.27	3.53	2.61
5.0	2.51	1.41	2.84	1.61	2.99	1.85	3.20	2.08	3.42	2.27	3.53	2.61
10.0	2.51	1.41	2.84	1.61	2.99	1.85	3.20	2.08	3.42	2.27	3.53	2.61
15.0	2.51	1.41	2.84	1.61	2.99	1.85	3.20	2.08	3.42	2.27	3.53	2.61
20.0	2.51	1.41	2.84	1.61	2.99	1.85	3.20	2.08	3.42	2.27	3.53	2.61
25.0	2.51	1.41	2.84	1.61	2.99	1.85	3.20	2.08	3.42	2.27	3.53	2.61
30.0	2.51	1.41	2.84	1.61	2.99	1.85	3.20	2.08	3.42	2.27	3.53	2.61
35.0	2.51	1.41	2.84	1.61	2.99	1.85	3.20	2.08	3.42	2.27	3.53	2.61
40.0	2.08	0.97	2.35	1.10	2.47	1.27	2.65	1.42	2.83	1.56	2.92	1.79
46.0	1.64	0.61	1.86	0.69	1.96	0.79	2.10	0.89	2.24	0.98	2.31	1.12

Model: ASYG12KMTB

Outdoor temperature	Indoor temperature (°CDB / °CWB)											
	18.0 / 12.0		21.0 / 15.0		23.0 / 16.0		27.0 / 19.0		29.0 / 21.0		32.0 / 23.0	
(°CDB)	TC	SHC	TC	SHC	TC	SHC	TC	SHC	TC	SHC	TC	SHC
-10.0	3.37	1.90	3.81	2.16	4.02	2.49	4.30	2.80	4.60	3.06	4.74	3.50
-5.0	3.37	1.90	3.81	2.16	4.02	2.49	4.30	2.80	4.60	3.06	4.74	3.50
0.0	3.37	1.90	3.81	2.16	4.02	2.49	4.30	2.80	4.60	3.06	4.74	3.50
5.0	3.37	1.90	3.81	2.16	4.02	2.49	4.30	2.80	4.60	3.06	4.74	3.50
10.0	3.37	1.90	3.81	2.16	4.02	2.49	4.30	2.80	4.60	3.06	4.74	3.50
15.0	3.37	1.90	3.81	2.16	4.02	2.49	4.30	2.80	4.60	3.06	4.74	3.50
20.0	3.37	1.90	3.81	2.16	4.02	2.49	4.30	2.80	4.60	3.06	4.74	3.50
25.0	3.37	1.90	3.81	2.16	4.02	2.49	4.30	2.80	4.60	3.06	4.74	3.50
30.0	3.37	1.90	3.81	2.16	4.02	2.49	4.30	2.80	4.60	3.06	4.74	3.50
35.0	3.37	1.90	3.81	2.16	4.02	2.49	4.30	2.80	4.60	3.06	4.74	3.50
40.0	2.79	1.30	3.15	1.48	3.32	1.70	3.56	1.91	3.80	2.09	3.92	2.40
46.0	2.21	0.81	2.50	0.93	2.63	1.07	2.82	1.20	3.01	1.31	3.11	1.50

Model: ASYG14KMTB

Outdoor temperature	Indoor temperature (°CDB / °CWB)											
	18.0 / 12.0		21.0 / 15.0		23.0 / 16.0		27.0 / 19.0		29.0 / 21.0		32.0 / 23.0	
(°CDB)	TC	SHC	TC	SHC	TC	SHC	TC	SHC	TC	SHC	TC	SHC
-10.0	3.92	2.20	4.43	2.51	4.67	2.89	5.00	3.25	5.35	3.55	5.51	4.07
-5.0	3.92	2.20	4.43	2.51	4.67	2.89	5.00	3.25	5.35	3.55	5.51	4.07
0.0	3.92	2.20	4.43	2.51	4.67	2.89	5.00	3.25	5.35	3.55	5.51	4.07
5.0	3.92	2.20	4.43	2.51	4.67	2.89	5.00	3.25	5.35	3.55	5.51	4.07
10.0	3.92	2.20	4.43	2.51	4.67	2.89	5.00	3.25	5.35	3.55	5.51	4.07
15.0	3.92	2.20	4.43	2.51	4.67	2.89	5.00	3.25	5.35	3.55	5.51	4.07
20.0	3.92	2.20	4.43	2.51	4.67	2.89	5.00	3.25	5.35	3.55	5.51	4.07
25.0	3.92	2.20	4.43	2.51	4.67	2.89	5.00	3.25	5.35	3.55	5.51	4.07
30.0	3.92	2.20	4.43	2.51	4.67	2.89	5.00	3.25	5.35	3.55	5.51	4.07
35.0	3.92	2.20	4.43	2.51	4.67	2.89	5.00	3.25	5.35	3.55	5.51	4.07
40.0	3.24	1.51	3.67	1.72	3.87	1.98	4.14	2.23	4.42	2.43	4.56	2.79
46.0	2.57	0.95	2.90	1.08	3.06	1.24	3.28	1.40	3.50	1.53	3.61	1.75

Model: ASYG07KMCC

Outdoor temperature	Indoor temperature (°CDB / °CWB)											
	18.0 / 12.0		21.0 / 15.0		23.0 / 16.0		27.0 / 19.0		29.0 / 21.0		32.0 / 23.0	
(°CDB)	TC	SHC	TC	SHC	TC	SHC	TC	SHC	TC	SHC	TC	SHC
-10.0	1.96	1.10	2.22	1.26	2.34	1.45	2.50	1.63	2.67	1.78	2.76	2.04
-5.0	1.96	1.10	2.22	1.26	2.34	1.45	2.50	1.63	2.67	1.78	2.76	2.04
0.0	1.96	1.10	2.22	1.26	2.34	1.45	2.50	1.63	2.67	1.78	2.76	2.04
5.0	1.96	1.10	2.22	1.26	2.34	1.45	2.50	1.63	2.67	1.78	2.76	2.04
10.0	1.96	1.10	2.22	1.26	2.34	1.45	2.50	1.63	2.67	1.78	2.76	2.04
15.0	1.96	1.10	2.22	1.26	2.34	1.45	2.50	1.63	2.67	1.78	2.76	2.04
20.0	1.96	1.10	2.22	1.26	2.34	1.45	2.50	1.63	2.67	1.78	2.76	2.04
25.0	1.96	1.10	2.22	1.26	2.34	1.45	2.50	1.63	2.67	1.78	2.76	2.04
30.0	1.96	1.10	2.22	1.26	2.34	1.45	2.50	1.63	2.67	1.78	2.76	2.04
35.0	1.96	1.10	2.22	1.26	2.34	1.45	2.50	1.63	2.67	1.78	2.76	2.04
40.0	1.62	0.75	1.83	0.86	1.93	0.99	2.07	1.11	2.21	1.22	2.28	1.39
46.0	1.28	0.47	1.45	0.54	1.53	0.62	1.64	0.70	1.75	0.76	1.81	0.87

Model: ASYG09KMCC

Outdoor temperature	Indoor temperature (°CDB / °CWB)											
	18.0 / 12.0		21.0 / 15.0		23.0 / 16.0		27.0 / 19.0		29.0 / 21.0		32.0 / 23.0	
(°CDB)	TC	SHC	TC	SHC	TC	SHC	TC	SHC	TC	SHC	TC	SHC
-10.0	2.51	1.41	2.84	1.61	2.99	1.85	3.20	2.08	3.42	2.27	3.53	2.61
-5.0	2.51	1.41	2.84	1.61	2.99	1.85	3.20	2.08	3.42	2.27	3.53	2.61
0.0	2.51	1.41	2.84	1.61	2.99	1.85	3.20	2.08	3.42	2.27	3.53	2.61
5.0	2.51	1.41	2.84	1.61	2.99	1.85	3.20	2.08	3.42	2.27	3.53	2.61
10.0	2.51	1.41	2.84	1.61	2.99	1.85	3.20	2.08	3.42	2.27	3.53	2.61
15.0	2.51	1.41	2.84	1.61	2.99	1.85	3.20	2.08	3.42	2.27	3.53	2.61
20.0	2.51	1.41	2.84	1.61	2.99	1.85	3.20	2.08	3.42	2.27	3.53	2.61
25.0	2.51	1.41	2.84	1.61	2.99	1.85	3.20	2.08	3.42	2.27	3.53	2.61
30.0	2.51	1.41	2.84	1.61	2.99	1.85	3.20	2.08	3.42	2.27	3.53	2.61
35.0	2.51	1.41	2.84	1.61	2.99	1.85	3.20	2.08	3.42	2.27	3.53	2.61
40.0	2.08	0.97	2.35	1.10	2.47	1.27	2.65	1.42	2.83	1.56	2.92	1.79
46.0	1.64	0.61	1.86	0.69	1.96	0.79	2.10	0.89	2.24	0.98	2.31	1.12

Model: ASYG12KMCC

Outdoor temperature	Indoor temperature (°CDB / °CWB)											
	18.0 / 12.0		21.0 / 15.0		23.0 / 16.0		27.0 / 19.0		29.0 / 21.0		32.0 / 23.0	
(°CDB)	TC	SHC	TC	SHC	TC	SHC	TC	SHC	TC	SHC	TC	SHC
-10.0	3.37	1.90	3.81	2.16	4.02	2.49	4.30	2.80	4.60	3.06	4.74	3.50
-5.0	3.37	1.90	3.81	2.16	4.02	2.49	4.30	2.80	4.60	3.06	4.74	3.50
0.0	3.37	1.90	3.81	2.16	4.02	2.49	4.30	2.80	4.60	3.06	4.74	3.50
5.0	3.37	1.90	3.81	2.16	4.02	2.49	4.30	2.80	4.60	3.06	4.74	3.50
10.0	3.37	1.90	3.81	2.16	4.02	2.49	4.30	2.80	4.60	3.06	4.74	3.50
15.0	3.37	1.90	3.81	2.16	4.02	2.49	4.30	2.80	4.60	3.06	4.74	3.50
20.0	3.37	1.90	3.81	2.16	4.02	2.49	4.30	2.80	4.60	3.06	4.74	3.50
25.0	3.37	1.90	3.81	2.16	4.02	2.49	4.30	2.80	4.60	3.06	4.74	3.50
30.0	3.37	1.90	3.81	2.16	4.02	2.49	4.30	2.80	4.60	3.06	4.74	3.50
35.0	3.37	1.90	3.81	2.16	4.02	2.49	4.30	2.80	4.60	3.06	4.74	3.50
40.0	2.79	1.30	3.15	1.48	3.32	1.70	3.56	1.91	3.80	2.09	3.92	2.40
46.0	2.21	0.81	2.50	0.93	2.63	1.07	2.82	1.20	3.01	1.31	3.11	1.50

Model: ASYG14KMCC

Outdoor temperature	Indoor temperature (°CDB / °CWB)											
	18.0 / 12.0		21.0 / 15.0		23.0 / 16.0		27.0 / 19.0		29.0 / 21.0		32.0 / 23.0	
(°CDB)	TC	SHC	TC	SHC	TC	SHC	TC	SHC	TC	SHC	TC	SHC
-10.0	3.92	2.20	4.43	2.51	4.67	2.89	5.00	3.25	5.35	3.55	5.51	4.07
-5.0	3.92	2.20	4.43	2.51	4.67	2.89	5.00	3.25	5.35	3.55	5.51	4.07
0.0	3.92	2.20	4.43	2.51	4.67	2.89	5.00	3.25	5.35	3.55	5.51	4.07
5.0	3.92	2.20	4.43	2.51	4.67	2.89	5.00	3.25	5.35	3.55	5.51	4.07
10.0	3.92	2.20	4.43	2.51	4.67	2.89	5.00	3.25	5.35	3.55	5.51	4.07
15.0	3.92	2.20	4.43	2.51	4.67	2.89	5.00	3.25	5.35	3.55	5.51	4.07
20.0	3.92	2.20	4.43	2.51	4.67	2.89	5.00	3.25	5.35	3.55	5.51	4.07
25.0	3.92	2.20	4.43	2.51	4.67	2.89	5.00	3.25	5.35	3.55	5.51	4.07
30.0	3.92	2.20	4.43	2.51	4.67	2.89	5.00	3.25	5.35	3.55	5.51	4.07
35.0	3.92	2.20	4.43	2.51	4.67	2.89	5.00	3.25	5.35	3.55	5.51	4.07
40.0	3.24	1.51	3.67	1.72	3.87	1.98	4.14	2.23	4.42	2.43	4.56	2.79
46.0	2.57	0.95	2.90	1.08	3.06	1.24	3.28	1.40	3.50	1.53	3.61	1.75

Model: ASYG07KETA, ASYG07KETA-B

Outdoor temperature	Indoor temperature (°CDB / °CWB)											
	18.0 / 12.0		21.0 / 15.0		23.0 / 16.0		27.0 / 19.0		29.0 / 21.0		32.0 / 23.0	
(°CDB)	TC	SHC	TC	SHC	TC	SHC	TC	SHC	TC	SHC	TC	SHC
-10.0	1.96	1.10	2.22	1.26	2.34	1.45	2.50	1.63	2.67	1.78	2.76	2.04
-5.0	1.96	1.10	2.22	1.26	2.34	1.45	2.50	1.63	2.67	1.78	2.76	2.04
0.0	1.96	1.10	2.22	1.26	2.34	1.45	2.50	1.63	2.67	1.78	2.76	2.04
5.0	1.96	1.10	2.22	1.26	2.34	1.45	2.50	1.63	2.67	1.78	2.76	2.04
10.0	1.96	1.10	2.22	1.26	2.34	1.45	2.50	1.63	2.67	1.78	2.76	2.04
15.0	1.96	1.10	2.22	1.26	2.34	1.45	2.50	1.63	2.67	1.78	2.76	2.04
20.0	1.96	1.10	2.22	1.26	2.34	1.45	2.50	1.63	2.67	1.78	2.76	2.04
25.0	1.96	1.10	2.22	1.26	2.34	1.45	2.50	1.63	2.67	1.78	2.76	2.04
30.0	1.96	1.10	2.22	1.26	2.34	1.45	2.50	1.63	2.67	1.78	2.76	2.04
35.0	1.96	1.10	2.22	1.26	2.34	1.45	2.50	1.63	2.67	1.78	2.76	2.04
40.0	1.62	0.75	1.83	0.86	1.93	0.99	2.07	1.11	2.21	1.22	2.28	1.39
46.0	1.28	0.47	1.45	0.54	1.53	0.62	1.64	0.70	1.75	0.76	1.81	0.87

Model: ASYG09KETA, ASYG09KETA-B

Outdoor temperature	Indoor temperature (°CDB / °CWB)											
	18.0 / 12.0		21.0 / 15.0		23.0 / 16.0		27.0 / 19.0		29.0 / 21.0		32.0 / 23.0	
(°CDB)	TC	SHC	TC	SHC	TC	SHC	TC	SHC	TC	SHC	TC	SHC
-10.0	2.51	1.41	2.84	1.61	2.99	1.85	3.20	2.08	3.42	2.27	3.53	2.61
-5.0	2.51	1.41	2.84	1.61	2.99	1.85	3.20	2.08	3.42	2.27	3.53	2.61
0.0	2.51	1.41	2.84	1.61	2.99	1.85	3.20	2.08	3.42	2.27	3.53	2.61
5.0	2.51	1.41	2.84	1.61	2.99	1.85	3.20	2.08	3.42	2.27	3.53	2.61
10.0	2.51	1.41	2.84	1.61	2.99	1.85	3.20	2.08	3.42	2.27	3.53	2.61
15.0	2.51	1.41	2.84	1.61	2.99	1.85	3.20	2.08	3.42	2.27	3.53	2.61
20.0	2.51	1.41	2.84	1.61	2.99	1.85	3.20	2.08	3.42	2.27	3.53	2.61
25.0	2.51	1.41	2.84	1.61	2.99	1.85	3.20	2.08	3.42	2.27	3.53	2.61
30.0	2.51	1.41	2.84	1.61	2.99	1.85	3.20	2.08	3.42	2.27	3.53	2.61
35.0	2.51	1.41	2.84	1.61	2.99	1.85	3.20	2.08	3.42	2.27	3.53	2.61
40.0	2.08	0.97	2.35	1.10	2.47	1.27	2.65	1.42	2.83	1.56	2.92	1.79
46.0	1.64	0.61	1.86	0.69	1.96	0.79	2.10	0.89	2.24	0.98	2.31	1.12

Model: ASYG12KETA, ASYG12KETA-B

Outdoor temperature	Indoor temperature (°CDB / °CWB)											
	18.0 / 12.0		21.0 / 15.0		23.0 / 16.0		27.0 / 19.0		29.0 / 21.0		32.0 / 23.0	
(°CDB)	TC	SHC	TC	SHC	TC	SHC	TC	SHC	TC	SHC	TC	SHC
-10.0	3.37	1.90	3.81	2.16	4.02	2.49	4.30	2.80	4.60	3.06	4.74	3.50
-5.0	3.37	1.90	3.81	2.16	4.02	2.49	4.30	2.80	4.60	3.06	4.74	3.50
0.0	3.37	1.90	3.81	2.16	4.02	2.49	4.30	2.80	4.60	3.06	4.74	3.50
5.0	3.37	1.90	3.81	2.16	4.02	2.49	4.30	2.80	4.60	3.06	4.74	3.50
10.0	3.37	1.90	3.81	2.16	4.02	2.49	4.30	2.80	4.60	3.06	4.74	3.50
15.0	3.37	1.90	3.81	2.16	4.02	2.49	4.30	2.80	4.60	3.06	4.74	3.50
20.0	3.37	1.90	3.81	2.16	4.02	2.49	4.30	2.80	4.60	3.06	4.74	3.50
25.0	3.37	1.90	3.81	2.16	4.02	2.49	4.30	2.80	4.60	3.06	4.74	3.50
30.0	3.37	1.90	3.81	2.16	4.02	2.49	4.30	2.80	4.60	3.06	4.74	3.50
35.0	3.37	1.90	3.81	2.16	4.02	2.49	4.30	2.80	4.60	3.06	4.74	3.50
40.0	2.79	1.30	3.15	1.48	3.32	1.70	3.56	1.91	3.80	2.09	3.92	2.40
46.0	2.21	0.81	2.50	0.93	2.63	1.07	2.82	1.20	3.01	1.31	3.11	1.50

Model: ASYG14KETA, ASYG14KETA-B

Outdoor temperature	Indoor temperature (°CDB / °CWB)											
	18.0 / 12.0		21.0 / 15.0		23.0 / 16.0		27.0 / 19.0		29.0 / 21.0		32.0 / 23.0	
(°CDB)	TC	SHC	TC	SHC	TC	SHC	TC	SHC	TC	SHC	TC	SHC
-10.0	3.92	2.20	4.43	2.51	4.67	2.89	5.00	3.25	5.35	3.55	5.51	4.07
-5.0	3.92	2.20	4.43	2.51	4.67	2.89	5.00	3.25	5.35	3.55	5.51	4.07
0.0	3.92	2.20	4.43	2.51	4.67	2.89	5.00	3.25	5.35	3.55	5.51	4.07
5.0	3.92	2.20	4.43	2.51	4.67	2.89	5.00	3.25	5.35	3.55	5.51	4.07
10.0	3.92	2.20	4.43	2.51	4.67	2.89	5.00	3.25	5.35	3.55	5.51	4.07
15.0	3.92	2.20	4.43	2.51	4.67	2.89	5.00	3.25	5.35	3.55	5.51	4.07
20.0	3.92	2.20	4.43	2.51	4.67	2.89	5.00	3.25	5.35	3.55	5.51	4.07
25.0	3.92	2.20	4.43	2.51	4.67	2.89	5.00	3.25	5.35	3.55	5.51	4.07
30.0	3.92	2.20	4.43	2.51	4.67	2.89	5.00	3.25	5.35	3.55	5.51	4.07
35.0	3.92	2.20	4.43	2.51	4.67	2.89	5.00	3.25	5.35	3.55	5.51	4.07
40.0	3.24	1.51	3.67	1.72	3.87	1.98	4.14	2.23	4.42	2.43	4.56	2.79
46.0	2.57	0.95	2.90	1.08	3.06	1.24	3.28	1.40	3.50	1.53	3.61	1.75

NOTES:

- TC: Total Capacity (kW), SHC: Sensible Heat Capacity (kW)
- Values mentioned in the table are based on the following conditions:
 - Pipe length: 5 m, Height difference: 0 m (Outdoor unit—Indoor unit)

● Ceiling type

Model: ABYG18KRTA

Outdoor temperature	Indoor temperature (°CDB / °CWB)											
	18.0 / 12.0		21.0 / 15.0		23.0 / 16.0		27.0 / 19.0		29.0 / 21.0		32.0 / 23.0	
(°CDB)	TC	SHC	TC	SHC	TC	SHC	TC	SHC	TC	SHC	TC	SHC
-10.0	4.75	2.96	5.37	3.37	5.66	3.88	6.06	4.36	6.48	4.77	6.68	5.47
-5.0	4.75	2.96	5.37	3.37	5.66	3.88	6.06	4.36	6.48	4.77	6.68	5.47
0.0	4.75	2.96	5.37	3.37	5.66	3.88	6.06	4.36	6.48	4.77	6.68	5.47
5.0	4.75	2.96	5.37	3.37	5.66	3.88	6.06	4.36	6.48	4.77	6.68	5.47
10.0	4.75	2.96	5.37	3.37	5.66	3.88	6.06	4.36	6.48	4.77	6.68	5.47
15.0	4.75	2.96	5.37	3.37	5.66	3.88	6.06	4.36	6.48	4.77	6.68	5.47
20.0	4.75	2.96	5.37	3.37	5.66	3.88	6.06	4.36	6.48	4.77	6.68	5.47
25.0	4.75	2.96	5.37	3.37	5.66	3.88	6.06	4.36	6.48	4.77	6.68	5.47
30.0	4.75	2.96	5.37	3.37	5.66	3.88	6.06	4.36	6.48	4.77	6.68	5.47
35.0	4.75	2.96	5.37	3.37	5.66	3.88	6.06	4.36	6.48	4.77	6.68	5.47
40.0	3.93	2.03	4.44	2.31	4.68	2.66	5.02	2.99	5.36	3.27	5.53	3.75
46.0	3.11	1.27	3.52	1.45	3.71	1.67	3.97	1.87	4.25	2.05	4.38	2.35

Model: ABYG22KRTA

Outdoor temperature	Indoor temperature (°CDB / °CWB)											
	18.0 / 12.0		21.0 / 15.0		23.0 / 16.0		27.0 / 19.0		29.0 / 21.0		32.0 / 23.0	
(°CDB)	TC	SHC	TC	SHC	TC	SHC	TC	SHC	TC	SHC	TC	SHC
-10.0	6.01	3.73	6.79	4.25	7.15	4.90	7.66	5.50	8.19	6.02	8.44	6.90
-5.0	6.01	3.73	6.79	4.25	7.15	4.90	7.66	5.50	8.19	6.02	8.44	6.90
0.0	6.01	3.73	6.79	4.25	7.15	4.90	7.66	5.50	8.19	6.02	8.44	6.90
5.0	6.01	3.73	6.79	4.25	7.15	4.90	7.66	5.50	8.19	6.02	8.44	6.90
10.0	6.01	3.73	6.79	4.25	7.15	4.90	7.66	5.50	8.19	6.02	8.44	6.90
15.0	6.01	3.73	6.79	4.25	7.15	4.90	7.66	5.50	8.19	6.02	8.44	6.90
20.0	6.01	3.73	6.79	4.25	7.15	4.90	7.66	5.50	8.19	6.02	8.44	6.90
25.0	6.01	3.73	6.79	4.25	7.15	4.90	7.66	5.50	8.19	6.02	8.44	6.90
30.0	6.01	3.73	6.79	4.25	7.15	4.90	7.66	5.50	8.19	6.02	8.44	6.90
35.0	6.01	3.73	6.79	4.25	7.15	4.90	7.66	5.50	8.19	6.02	8.44	6.90
40.0	4.97	2.56	5.62	2.91	5.92	3.35	6.34	3.77	6.78	4.12	6.99	4.72
46.0	3.94	1.60	4.45	1.83	4.69	2.10	5.02	2.36	5.37	2.58	5.53	2.96

NOTES:

- TC: Total Capacity (kW), SHC: Sensible Heat Capacity (kW)
- Values mentioned in the table are based on the following conditions:
 - Pipe length: 5 m, Height difference: 0 m (Outdoor unit—Indoor unit)

● Floor type

Model: AGYG09KVCA

Outdoor temperature	Indoor temperature (°CDB / °CWB)											
	18.0 / 12.0		21.0 / 15.0		23.0 / 16.0		27.0 / 19.0		29.0 / 21.0		32.0 / 23.0	
(°CDB)	TC	SHC	TC	SHC	TC	SHC	TC	SHC	TC	SHC	TC	SHC
-10.0	2.51	1.71	2.84	1.95	2.99	2.25	3.20	2.53	3.42	2.76	3.53	3.17
-5.0	2.51	1.71	2.84	1.95	2.99	2.25	3.20	2.53	3.42	2.76	3.53	3.17
0.0	2.51	1.71	2.84	1.95	2.99	2.25	3.20	2.53	3.42	2.76	3.53	3.17
5.0	2.51	1.71	2.84	1.95	2.99	2.25	3.20	2.53	3.42	2.76	3.53	3.17
10.0	2.51	1.71	2.84	1.95	2.99	2.25	3.20	2.53	3.42	2.76	3.53	3.17
15.0	2.51	1.71	2.84	1.95	2.99	2.25	3.20	2.53	3.42	2.76	3.53	3.17
20.0	2.51	1.71	2.84	1.95	2.99	2.25	3.20	2.53	3.42	2.76	3.53	3.17
25.0	2.51	1.71	2.84	1.95	2.99	2.25	3.20	2.53	3.42	2.76	3.53	3.17
30.0	2.51	1.71	2.84	1.95	2.99	2.25	3.20	2.53	3.42	2.76	3.53	3.17
35.0	2.51	1.71	2.84	1.95	2.99	2.25	3.20	2.53	3.42	2.76	3.53	3.17
40.0	2.08	1.17	2.35	1.34	2.47	1.54	2.65	1.73	2.83	1.89	2.92	2.17
46.0	1.64	0.74	1.86	0.84	1.96	0.97	2.10	1.09	2.24	1.19	2.31	1.36

OUTDOOR UNIT
AOYG30KBTA4OUTDOOR UNIT
AOYG30KBTA4

Model: AGYG12KVCA

Outdoor temperature	Indoor temperature (°CDB / °CWB)											
	18.0 / 12.0		21.0 / 15.0		23.0 / 16.0		27.0 / 19.0		29.0 / 21.0		32.0 / 23.0	
(°CDB)	TC	SHC	TC	SHC	TC	SHC	TC	SHC	TC	SHC	TC	SHC
-10.0	3.37	2.16	3.81	2.46	4.02	2.83	4.30	3.18	4.60	3.48	4.74	3.99
-5.0	3.37	2.16	3.81	2.46	4.02	2.83	4.30	3.18	4.60	3.48	4.74	3.99
0.0	3.37	2.16	3.81	2.46	4.02	2.83	4.30	3.18	4.60	3.48	4.74	3.99
5.0	3.37	2.16	3.81	2.46	4.02	2.83	4.30	3.18	4.60	3.48	4.74	3.99
10.0	3.37	2.16	3.81	2.46	4.02	2.83	4.30	3.18	4.60	3.48	4.74	3.99
15.0	3.37	2.16	3.81	2.46	4.02	2.83	4.30	3.18	4.60	3.48	4.74	3.99
20.0	3.37	2.16	3.81	2.46	4.02	2.83	4.30	3.18	4.60	3.48	4.74	3.99
25.0	3.37	2.16	3.81	2.46	4.02	2.83	4.30	3.18	4.60	3.48	4.74	3.99
30.0	3.37	2.16	3.81	2.46	4.02	2.83	4.30	3.18	4.60	3.48	4.74	3.99
35.0	3.37	2.16	3.81	2.46	4.02	2.83	4.30	3.18	4.60	3.48	4.74	3.99
40.0	2.79	1.48	3.15	1.69	3.32	1.94	3.56	2.18	3.80	2.38	3.92	2.73
46.0	2.21	0.93	2.50	1.06	2.63	1.22	2.82	1.37	3.01	1.49	3.11	1.71

Model: AGYG14KVCA

Outdoor temperature	Indoor temperature (°CDB / °CWB)											
	18.0 / 12.0		21.0 / 15.0		23.0 / 16.0		27.0 / 19.0		29.0 / 21.0		32.0 / 23.0	
(°CDB)	TC	SHC	TC	SHC	TC	SHC	TC	SHC	TC	SHC	TC	SHC
-10.0	3.92	2.44	4.43	2.78	4.67	3.20	5.00	3.60	5.35	3.94	5.51	4.51
-5.0	3.92	2.44	4.43	2.78	4.67	3.20	5.00	3.60	5.35	3.94	5.51	4.51
0.0	3.92	2.44	4.43	2.78	4.67	3.20	5.00	3.60	5.35	3.94	5.51	4.51
5.0	3.92	2.44	4.43	2.78	4.67	3.20	5.00	3.60	5.35	3.94	5.51	4.51
10.0	3.92	2.44	4.43	2.78	4.67	3.20	5.00	3.60	5.35	3.94	5.51	4.51
15.0	3.92	2.44	4.43	2.78	4.67	3.20	5.00	3.60	5.35	3.94	5.51	4.51
20.0	3.92	2.44	4.43	2.78	4.67	3.20	5.00	3.60	5.35	3.94	5.51	4.51
25.0	3.92	2.44	4.43	2.78	4.67	3.20	5.00	3.60	5.35	3.94	5.51	4.51
30.0	3.92	2.44	4.43	2.78	4.67	3.20	5.00	3.60	5.35	3.94	5.51	4.51
35.0	3.92	2.44	4.43	2.78	4.67	3.20	5.00	3.60	5.35	3.94	5.51	4.51
40.0	3.24	1.67	3.67	1.91	3.87	2.19	4.14	2.47	4.42	2.70	4.56	3.09
46.0	2.57	1.05	2.90	1.20	3.06	1.38	3.28	1.55	3.50	1.69	3.61	1.94

NOTES:

- TC: Total Capacity (kW), SHC: Sensible Heat Capacity (kW)
- Values mentioned in the table are based on the following conditions:
 - Pipe length: 5 m, Height difference: 0 m (Outdoor unit—Indoor unit)

6-3. Heating capacity

NOTE: Values mentioned in the table are calculated based on the maximum capacity.

Model: AOYG30KBTA4

Indoor unit connecting capacity	Outdoor temperature		Indoor temperature									
			16.0 °CDB		18.0 °CDB		20.0 °CDB		22.0 °CDB		24.0 °CDB	
kBtu/h	°CDB	°CWB	TC	IP	TC	IP	TC	IP	TC	IP	TC	IP
49	-15.0	-16.0	6.1	2.96	6.0	3.02	5.9	3.08	5.7	3.14	5.6	3.20
	-10.0	-11.0	7.6	3.24	7.5	3.31	7.3	3.38	7.1	3.45	6.9	3.51
	-5.0	-7.0	9.1	3.13	8.9	3.20	8.7	3.26	8.4	3.33	8.2	3.39
	0.0	-2.0	10.7	3.35	10.4	3.42	10.2	3.49	9.9	3.56	9.7	3.63
	5.0	3.0	11.8	3.21	11.5	3.27	11.2	3.34	10.9	3.41	10.6	3.47
	7.0	6.0	11.8	2.91	11.5	2.97	11.2	3.03	10.9	3.09	10.6	3.15
	10.0	8.0	11.8	2.80	11.5	2.86	11.2	2.92	10.9	2.98	10.6	3.04
	15.0	10.0	11.8	2.44	11.5	2.50	11.2	2.55	10.9	2.60	10.6	2.65
	20.0	15.0	11.8	2.06	11.5	2.10	11.2	2.14	10.9	2.19	10.6	2.23
24.0	18.0	11.8	1.87	11.5	1.91	11.2	1.94	10.9	1.98	10.6	2.02	
48	-15.0	-16.0	6.1	2.96	6.0	3.02	5.9	3.08	5.7	3.14	5.6	3.20
	-10.0	-11.0	7.6	3.24	7.5	3.31	7.3	3.38	7.1	3.45	6.9	3.51
	-5.0	-7.0	9.1	3.13	8.9	3.20	8.7	3.26	8.4	3.33	8.2	3.39
	0.0	-2.0	10.7	3.35	10.4	3.42	10.2	3.49	9.9	3.56	9.7	3.63
	5.0	3.0	11.8	3.21	11.5	3.27	11.2	3.34	10.9	3.41	10.6	3.47
	7.0	6.0	11.8	2.91	11.5	2.97	11.2	3.03	10.9	3.09	10.6	3.15
	10.0	8.0	11.8	2.80	11.5	2.86	11.2	2.92	10.9	2.98	10.6	3.04
	15.0	10.0	11.8	2.44	11.5	2.50	11.2	2.55	10.9	2.60	10.6	2.65
	20.0	15.0	11.8	2.06	11.5	2.10	11.2	2.14	10.9	2.19	10.6	2.23
24.0	18.0	11.8	1.87	11.5	1.91	11.2	1.94	10.9	1.98	10.6	2.02	
47	-15.0	-16.0	6.1	2.96	6.0	3.02	5.9	3.08	5.7	3.14	5.6	3.20
	-10.0	-11.0	7.6	3.24	7.5	3.31	7.3	3.38	7.1	3.45	6.9	3.51
	-5.0	-7.0	9.1	3.13	8.9	3.20	8.7	3.26	8.4	3.33	8.2	3.39
	0.0	-2.0	10.7	3.35	10.4	3.42	10.2	3.49	9.9	3.56	9.7	3.63
	5.0	3.0	11.8	3.21	11.5	3.27	11.2	3.34	10.9	3.41	10.6	3.47
	7.0	6.0	11.8	2.91	11.5	2.97	11.2	3.03	10.9	3.09	10.6	3.15
	10.0	8.0	11.8	2.80	11.5	2.86	11.2	2.92	10.9	2.98	10.6	3.04
	15.0	10.0	11.8	2.44	11.5	2.50	11.2	2.55	10.9	2.60	10.6	2.65
	20.0	15.0	11.8	2.06	11.5	2.10	11.2	2.14	10.9	2.19	10.6	2.23
24.0	18.0	11.8	1.87	11.5	1.91	11.2	1.94	10.9	1.98	10.6	2.02	
46	-15.0	-16.0	6.1	2.96	6.0	3.02	5.9	3.08	5.7	3.14	5.6	3.20
	-10.0	-11.0	7.6	3.24	7.5	3.31	7.3	3.38	7.1	3.45	6.9	3.51
	-5.0	-7.0	9.1	3.13	8.9	3.20	8.7	3.26	8.4	3.33	8.2	3.39
	0.0	-2.0	10.7	3.35	10.4	3.42	10.2	3.49	9.9	3.56	9.7	3.63
	5.0	3.0	11.8	3.21	11.5	3.27	11.2	3.34	10.9	3.41	10.6	3.47
	7.0	6.0	11.8	2.91	11.5	2.97	11.2	3.03	10.9	3.09	10.6	3.15
	10.0	8.0	11.8	2.80	11.5	2.86	11.2	2.92	10.9	2.98	10.6	3.04
	15.0	10.0	11.8	2.44	11.5	2.50	11.2	2.55	10.9	2.60	10.6	2.65
	20.0	15.0	11.8	2.06	11.5	2.10	11.2	2.14	10.9	2.19	10.6	2.23
24.0	18.0	11.8	1.87	11.5	1.91	11.2	1.94	10.9	1.98	10.6	2.02	
45	-15.0	-16.0	6.1	2.96	6.0	3.02	5.9	3.08	5.7	3.14	5.6	3.20
	-10.0	-11.0	7.6	3.24	7.5	3.31	7.3	3.38	7.1	3.45	6.9	3.51
	-5.0	-7.0	9.1	3.13	8.9	3.20	8.7	3.26	8.4	3.33	8.2	3.39
	0.0	-2.0	10.7	3.35	10.4	3.42	10.2	3.49	9.9	3.56	9.7	3.63
	5.0	3.0	11.8	3.21	11.5	3.27	11.2	3.34	10.9	3.41	10.6	3.47
	7.0	6.0	11.8	2.91	11.5	2.97	11.2	3.03	10.9	3.09	10.6	3.15
	10.0	8.0	11.8	2.80	11.5	2.86	11.2	2.92	10.9	2.98	10.6	3.04
	15.0	10.0	11.8	2.44	11.5	2.50	11.2	2.55	10.9	2.60	10.6	2.65
	20.0	15.0	11.8	2.06	11.5	2.10	11.2	2.14	10.9	2.19	10.6	2.23
24.0	18.0	11.8	1.87	11.5	1.91	11.2	1.94	10.9	1.98	10.6	2.02	
44	-15.0	-16.0	6.1	2.96	6.0	3.02	5.9	3.08	5.7	3.14	5.6	3.20
	-10.0	-11.0	7.6	3.24	7.5	3.31	7.3	3.38	7.1	3.45	6.9	3.51
	-5.0	-7.0	9.1	3.13	8.9	3.20	8.7	3.26	8.4	3.33	8.2	3.39
	0.0	-2.0	10.7	3.35	10.4	3.42	10.2	3.49	9.9	3.56	9.7	3.63
	5.0	3.0	11.8	3.21	11.5	3.27	11.2	3.34	10.9	3.41	10.6	3.47
	7.0	6.0	11.8	2.91	11.5	2.97	11.2	3.03	10.9	3.09	10.6	3.15
	10.0	8.0	11.8	2.80	11.5	2.86	11.2	2.92	10.9	2.98	10.6	3.04
	15.0	10.0	11.8	2.44	11.5	2.50	11.2	2.55	10.9	2.60	10.6	2.65
	20.0	15.0	11.8	2.06	11.5	2.10	11.2	2.14	10.9	2.19	10.6	2.23
24.0	18.0	11.8	1.87	11.5	1.91	11.2	1.94	10.9	1.98	10.6	2.02	
43	-15.0	-16.0	6.1	2.96	6.0	3.02	5.9	3.08	5.7	3.14	5.6	3.20
	-10.0	-11.0	7.6	3.24	7.5	3.31	7.3	3.38	7.1	3.45	6.9	3.51
	-5.0	-7.0	9.1	3.13	8.9	3.20	8.7	3.26	8.4	3.33	8.2	3.39
	0.0	-2.0	10.7	3.35	10.4	3.42	10.2	3.49	9.9	3.56	9.7	3.63
	5.0	3.0	11.8	3.21	11.5	3.27	11.2	3.34	10.9	3.41	10.6	3.47
	7.0	6.0	11.8	2.91	11.5	2.97	11.2	3.03	10.9	3.09	10.6	3.15
	10.0	8.0	11.8	2.80	11.5	2.86	11.2	2.92	10.9	2.98	10.6	3.04
	15.0	10.0	11.8	2.44	11.5	2.50	11.2	2.55	10.9	2.60	10.6	2.65
	20.0	15.0	11.8	2.06	11.5	2.10	11.2	2.14	10.9	2.19	10.6	2.23
24.0	18.0	11.8	1.87	11.5	1.91	11.2	1.94	10.9	1.98	10.6	2.02	
42	-15.0	-16.0	6.1	2.96	6.0	3.02	5.9	3.08	5.7	3.14	5.6	3.20
	-10.0	-11.0	7.6	3.24	7.5	3.31	7.3	3.38	7.1	3.45	6.9	3.51
	-5.0	-7.0	9.1	3.13	8.9	3.20	8.7	3.26	8.4	3.33	8.2	3.39
	0.0	-2.0	10.7	3.35	10.4	3.42	10.2	3.49	9.9	3.56	9.7	3.63
	5.0	3.0	11.8	3.21	11.5	3.27	11.2	3.34	10.9	3.41	10.6	3.47
	7.0	6.0	11.8	2.91	11.5	2.97	11.2	3.03	10.9	3.09	10.6	3.15
	10.0	8.0	11.8	2.80	11.5	2.86	11.2	2.92	10.9	2.98	10.6	3.04
	15.0	10.0	11.8	2.44	11.5	2.50	11.2	2.55	10.9	2.60	10.6	2.65
	20.0	15.0	11.8	2.06	11.5	2.10	11.2	2.14	10.9	2.19	10.6	2.23
24.0	18.0	11.8	1.87	11.5	1.91	11.2	1.94	10.9	1.98	10.6	2.02	

Indoor unit connecting capacity	Outdoor temperature		Indoor temperature									
			16.0 °CDB		18.0 °CDB		20.0 °CDB		22.0 °CDB		24.0 °CDB	
kBtu/h	°CDB	°CWB	TC	IP	TC	IP	TC	IP	TC	IP	TC	IP
32	-15.0	-16.0	6.1	2.96	6.0	3.02	5.9	3.08	5.7	3.14	5.6	3.20
	-10.0	-11.0	7.6	3.24	7.5	3.31	7.3	3.38	7.1	3.45	6.9	3.51
	-5.0	-7.0	9.1	3.13	8.9	3.20	8.7	3.26	8.4	3.33	8.2	3.39
	0.0	-2.0	10.7	3.35	10.4	3.42	10.2	3.49	9.9	3.56	9.7	3.63
	5.0	3.0	11.8	3.21	11.5	3.27	11.2	3.34	10.9	3.41	10.6	3.47
	7.0	6.0	11.8	2.91	11.5	2.97	11.2	3.03	10.9	3.09	10.6	3.15
	10.0	8.0	11.8	2.80	11.5	2.86	11.2	2.92	10.9	2.98	10.6	3.04
	15.0	10.0	11.8	2.44	11.5	2.50	11.2	2.55	10.9	2.60	10.6	2.65
	20.0	15.0	11.8	2.06	11.5	2.10	11.2	2.14	10.9	2.19	10.6	2.23
31	24.0	18.0	11.8	1.87	11.5	1.91	11.2	1.94	10.9	1.98	10.6	2.02
	-15.0	-16.0	6.1	2.96	6.0	3.02	5.9	3.08	5.7	3.14	5.6	3.20
	-10.0	-11.0	7.6	3.24	7.5	3.31	7.3	3.38	7.1	3.45	6.9	3.51
	-5.0	-7.0	9.1	3.13	8.9	3.20	8.7	3.26	8.4	3.33	8.2	3.39
	0.0	-2.0	10.7	3.35	10.4	3.42	10.2	3.49	9.9	3.56	9.7	3.63
	5.0	3.0	11.8	3.21	11.5	3.27	11.2	3.34	10.9	3.41	10.6	3.47
	7.0	6.0	11.8	2.91	11.5	2.97	11.2	3.03	10.9	3.09	10.6	3.15
	10.0	8.0	11.8	2.80	11.5	2.86	11.2	2.92	10.9	2.98	10.6	3.04
	15.0	10.0	11.8	2.44	11.5	2.50	11.2	2.55	10.9	2.60	10.6	2.65
30	20.0	15.0	11.8	2.06	11.5	2.10	11.2	2.14	10.9	2.19	10.6	2.23
	24.0	18.0	11.8	1.87	11.5	1.91	11.2	1.94	10.9	1.98	10.6	2.02
	-15.0	-16.0	6.1	2.96	6.0	3.02	5.9	3.08	5.7	3.14	5.6	3.20
	-10.0	-11.0	7.6	3.24	7.5	3.31	7.3	3.38	7.1	3.45	6.9	3.51
	-5.0	-7.0	9.1	3.13	8.9	3.20	8.7	3.26	8.4	3.33	8.2	3.39
	0.0	-2.0	10.7	3.35	10.4	3.42	10.2	3.49	9.9	3.56	9.7	3.63
	5.0	3.0	11.8	3.21	11.5	3.27	11.2	3.34	10.9	3.41	10.6	3.47
	7.0	6.0	11.8	2.91	11.5	2.97	11.2	3.03	10.9	3.09	10.6	3.15
	10.0	8.0	11.8	2.80	11.5	2.86	11.2	2.92	10.9	2.98	10.6	3.04
29	15.0	10.0	11.8	2.44	11.5	2.50	11.2	2.55	10.9	2.60	10.6	2.65
	20.0	15.0	11.8	2.06	11.5	2.10	11.2	2.14	10.9	2.19	10.6	2.23
	24.0	18.0	11.8	1.87	11.5	1.91	11.2	1.94	10.9	1.98	10.6	2.02
	-15.0	-16.0	6.1	2.96	6.0	3.02	5.9	3.08	5.7	3.14	5.6	3.20
	-10.0	-11.0	7.6	3.24	7.5	3.31	7.3	3.38	7.1	3.45	6.9	3.51
	-5.0	-7.0	9.1	3.13	8.9	3.20	8.7	3.26	8.4	3.33	8.2	3.39
	0.0	-2.0	10.7	3.35	10.4	3.42	10.2	3.49	9.9	3.56	9.7	3.63
	5.0	3.0	11.8	3.21	11.5	3.27	11.2	3.34	10.9	3.41	10.6	3.47
	7.0	6.0	11.8	2.91	11.5	2.97	11.2	3.03	10.9	3.09	10.6	3.15
28	10.0	8.0	11.8	2.80	11.5	2.86	11.2	2.92	10.9	2.98	10.6	3.04
	15.0	10.0	11.8	2.44	11.5	2.50	11.2	2.55	10.9	2.60	10.6	2.65
	20.0	15.0	11.8	2.06	11.5	2.10	11.2	2.14	10.9	2.19	10.6	2.23
	24.0	18.0	11.8	1.87	11.5	1.91	11.2	1.94	10.9	1.98	10.6	2.02
	-15.0	-16.0	6.1	2.96	6.0	3.02	5.9	3.08	5.7	3.14	5.6	3.20
	-10.0	-11.0	7.6	3.24	7.5	3.31	7.3	3.38	7.1	3.45	6.9	3.51
	-5.0	-7.0	9.1	3.13	8.9	3.20	8.7	3.26	8.4	3.33	8.2	3.39
	0.0	-2.0	10.7	3.35	10.4	3.42	10.2	3.49	9.9	3.56	9.7	3.63
	5.0	3.0	11.8	3.21	11.5	3.27	11.2	3.34	10.9	3.41	10.6	3.47
27	7.0	6.0	11.8	2.91	11.5	2.97	11.2	3.03	10.9	3.09	10.6	3.15
	10.0	8.0	11.8	2.80	11.5	2.86	11.2	2.92	10.9	2.98	10.6	3.04
	15.0	10.0	11.8	2.44	11.5	2.50	11.2	2.55	10.9	2.60	10.6	2.65
	20.0	15.0	11.8	2.06	11.5	2.10	11.2	2.14	10.9	2.19	10.6	2.23
	24.0	18.0	11.8	1.87	11.5	1.91	11.2	1.94	10.9	1.98	10.6	2.02
	-15.0	-16.0	5.9	2.76	5.8	2.81	5.6	2.87	5.5	2.93	5.4	2.99
	-10.0	-11.0	7.4	3.03	7.2	3.09	7.0	3.15	6.8	3.22	6.7	3.28
	-5.0	-7.0	8.8	2.92	8.6	2.98	8.4	3.04	8.1	3.10	7.9	3.16
	0.0	-2.0	10.3	3.13	10.1	3.19	9.8	3.26	9.6	3.32	9.3	3.39
26	5.0	3.0	11.3	2.99	11.1	3.05	10.8	3.12	10.5	3.18	10.3	3.24
	7.0	6.0	11.3	2.72	11.1	2.77	10.8	2.83	10.5	2.89	10.3	2.94
	10.0	8.0	11.3	2.61	11.1	2.67	10.8	2.72	10.5	2.78	10.3	2.83
	15.0	10.0	11.3	2.28	11.1	2.33	10.8	2.38	10.5	2.42	10.3	2.47
	20.0	15.0	11.3	1.92	11.1	1.96	10.8	2.00	10.5	2.04	10.3	2.08
	24.0	18.0	11.3	1.74	11.1	1.78	10.8	1.81	10.5	1.85	10.3	1.89
	-15.0	-16.0	5.7	2.64	5.6	2.70	5.4	2.75	5.3	2.81	5.2	2.86
	-10.0	-11.0	7.1	2.90	6.9	2.96	6.8	3.02	6.6	3.08	6.4	3.14
	-5.0	-7.0	8.4	2.80	8.2	2.86	8.0	2.91	7.8	2.97	7.6	3.03
25	0.0	-2.0	9.9	2.99	9.7	3.06	9.5	3.12	9.2	3.18	9.0	3.24
	5.0	3.0	10.9	2.86	10.7	2.92	10.4	2.98	10.1	3.04	9.9	3.10
	7.0	6.0	10.9	2.60	10.7	2.66	10.4	2.71	10.1	2.76	9.9	2.82
	10.0	8.0	10.9	2.50	10.7	2.56	10.4	2.61	10.1	2.66	9.9	2.71
	15.0	10.0	10.9	2.18	10.7	2.23	10.4	2.27	10.1	2.32	9.9	2.37
	20.0	15.0	10.9	1.84	10.7	1.88	10.4	1.92	10.1	1.95	9.9	1.99
	24.0	18.0	10.9	1.67	10.7	1.70	10.4	1.74	10.1	1.77	9.9	1.81
	-15.0	-16.0	5.5	2.52	5.4	2.58	5.2	2.63	5.1	2.68	5.0	2.73
	-10.0	-11.0	6.8	2.77	6.7	2.83	6.5	2.88	6.3	2.94	6.2	3.00
24	-5.0	-7.0	8.1	2.67	7.9	2.73	7.7	2.78	7.5	2.84	7.4	2.90
	0.0	-2.0	9.6	2.86	9.3	2.92	9.1	2.98	8.9	3.04	8.6	3.10
	5.0	3.0	10.5	2.74	10.3	2.79	10.0	2.85	9.8	2.91	9.5	2.97
	7.0	6.0	10.5	2.49	10.3	2.54	10.0	2.59	9.8	2.64	9.5	2.69
	10.0	8.0	10.5	2.39	10.3	2.44	10.0	2.49	9.8	2.54	9.5	2.59
	15.0	10.0	10.5	2.09	10.3	2.13	10.0	2.17	9.8	2.22	9.5	2.26
	20.0	15.0	10.5	1.76	10.3	1.79	10.0	1.83	9.8	1.87	9.5	1.90
	24.0	18.0	10.5	1.59	10.3	1.63	10.0	1.66	9.8	1.69	9.5	1.73

NOTES:

- TC: Total Capacity (kW), IP: Input Power (kW)
- Values mentioned in the table are based on the following conditions:
 - Power source of specifications: 230 V
 - Pipe length: 5 m, Height difference: 0 m (Outdoor unit—Indoor unit)
- 2 or more indoor units should be connected.
- The total ability of connected a indoor unit is from 25,000 Btu/h up to 49,000 Btu/h.
- Input in the table are calculated based on the maximum indoor unit input combinations.

● Compact cassette type

Model: AUXG07KVLA

Outdoor temperature		Indoor temperature (°CDB)				
		16.0	18.0	20.0	22.0	24.0
(°CDB)	(°CWB)	TC	TC	TC	TC	TC
-15.0	-16.0	1.54	1.50	1.46	1.43	1.39
-10.0	-11.0	1.91	1.87	1.82	1.78	1.73
-5.0	-7.0	2.27	2.22	2.17	2.11	2.06
0.0	-2.0	2.68	2.61	2.55	2.48	2.42
5.0	3.0	2.94	2.87	2.80	2.73	2.66
7.0	6.0	2.94	2.87	2.80	2.73	2.66
10.0	8.0	2.94	2.87	2.80	2.73	2.66
15.0	10.0	2.94	2.87	2.80	2.73	2.66
20.0	15.0	2.94	2.87	2.80	2.73	2.66
24.0	18.0	2.94	2.87	2.80	2.73	2.66

OUTDOOR UNIT
AOYG30KETA4OUTDOOR UNIT
AOYG30KETA4

Model: AUXG09KVLA

Outdoor temperature		Indoor temperature (°CDB)				
		16.0	18.0	20.0	22.0	24.0
(°CDB)	(°CWB)	TC	TC	TC	TC	TC
-15.0	-16.0	1.97	1.93	1.88	1.83	1.79
-10.0	-11.0	2.46	2.40	2.34	2.28	2.22
-5.0	-7.0	2.92	2.86	2.79	2.72	2.65
0.0	-2.0	3.44	3.36	3.28	3.19	3.11
5.0	3.0	3.78	3.69	3.60	3.51	3.42
7.0	6.0	3.78	3.69	3.60	3.51	3.42
10.0	8.0	3.78	3.69	3.60	3.51	3.42
15.0	10.0	3.78	3.69	3.60	3.51	3.42
20.0	15.0	3.78	3.69	3.60	3.51	3.42
24.0	18.0	3.78	3.69	3.60	3.51	3.42

Model: AUXG12KVLA

Outdoor temperature		Indoor temperature (°CDB)				
		16.0	18.0	20.0	22.0	24.0
(°CDB)	(°CWB)	TC	TC	TC	TC	TC
-15.0	-16.0	2.63	2.57	2.51	2.44	2.38
-10.0	-11.0	3.28	3.20	3.12	3.04	2.97
-5.0	-7.0	3.90	3.81	3.71	3.62	3.53
0.0	-2.0	4.59	4.48	4.37	4.26	4.15
5.0	3.0	5.04	4.92	4.80	4.68	4.56
7.0	6.0	5.04	4.92	4.80	4.68	4.56
10.0	8.0	5.04	4.92	4.80	4.68	4.56
15.0	10.0	5.04	4.92	4.80	4.68	4.56
20.0	15.0	5.04	4.92	4.80	4.68	4.56
24.0	18.0	5.04	4.92	4.80	4.68	4.56

Model: AUXG14KVLA

Outdoor temperature		Indoor temperature (°CDB)				
		16.0	18.0	20.0	22.0	24.0
(°CDB)	(°CWB)	TC	TC	TC	TC	TC
-15.0	-16.0	3.07	3.00	2.93	2.85	2.78
-10.0	-11.0	3.82	3.73	3.64	3.55	3.46
-5.0	-7.0	4.55	4.44	4.33	4.22	4.12
0.0	-2.0	5.35	5.22	5.10	4.97	4.84
5.0	3.0	5.88	5.74	5.60	5.46	5.32
7.0	6.0	5.88	5.74	5.60	5.46	5.32
10.0	8.0	5.88	5.74	5.60	5.46	5.32
15.0	10.0	5.88	5.74	5.60	5.46	5.32
20.0	15.0	5.88	5.74	5.60	5.46	5.32
24.0	18.0	5.88	5.74	5.60	5.46	5.32

Model: AUXG18KVLA

Outdoor temperature		Indoor temperature (°CDB)				
		16.0	18.0	20.0	22.0	24.0
(°CDB)	(°CWB)	TC	TC	TC	TC	TC
-15.0	-16.0	3.69	3.60	3.51	3.42	3.33
-10.0	-11.0	4.59	4.48	4.37	4.26	4.15
-5.0	-7.0	5.46	5.33	5.20	5.07	4.94
0.0	-2.0	6.42	6.27	6.11	5.96	5.81
5.0	3.0	7.06	6.89	6.72	6.55	6.38
7.0	6.0	7.06	6.89	6.72	6.55	6.38
10.0	8.0	7.06	6.89	6.72	6.55	6.38
15.0	10.0	7.06	6.89	6.72	6.55	6.38
20.0	15.0	7.06	6.89	6.72	6.55	6.38
24.0	18.0	7.06	6.89	6.72	6.55	6.38

Model: AUXG22KVLA

Outdoor temperature		Indoor temperature (°CDB)				
		16.0	18.0	20.0	22.0	24.0
(°CDB)	(°CWB)	TC	TC	TC	TC	TC
-15.0	-16.0	4.66	4.55	4.44	4.33	4.22
-10.0	-11.0	5.80	5.67	5.53	5.39	5.25
-5.0	-7.0	6.91	6.74	6.58	6.41	6.25
0.0	-2.0	8.12	7.93	7.73	7.54	7.35
5.0	3.0	8.93	8.71	8.50	8.29	8.08
7.0	6.0	8.93	8.71	8.50	8.29	8.08
10.0	8.0	8.93	8.71	8.50	8.29	8.08
15.0	10.0	8.93	8.71	8.50	8.29	8.08
20.0	15.0	8.93	8.71	8.50	8.29	8.08
24.0	18.0	8.93	8.71	8.50	8.29	8.08

NOTES:

- TC: Total Capacity (kW)
- Values mentioned in the table are based on the following conditions:
 - Pipe length: 5 m, Height difference: 0 m (Outdoor unit—Indoor unit)

● Mini duct type

Model: ARXG07KSLAP

Outdoor temperature		Indoor temperature (°CDB)				
		16.0	18.0	20.0	22.0	24.0
(°CDB)	(°CWB)	TC	TC	TC	TC	TC
-15.0	-16.0	1.54	1.50	1.46	1.43	1.39
-10.0	-11.0	1.91	1.87	1.82	1.78	1.73
-5.0	-7.0	2.27	2.22	2.17	2.11	2.06
0.0	-2.0	2.68	2.61	2.55	2.48	2.42
5.0	3.0	2.94	2.87	2.80	2.73	2.66
7.0	6.0	2.94	2.87	2.80	2.73	2.66
10.0	8.0	2.94	2.87	2.80	2.73	2.66
15.0	10.0	2.94	2.87	2.80	2.73	2.66
20.0	15.0	2.94	2.87	2.80	2.73	2.66
24.0	18.0	2.94	2.87	2.80	2.73	2.66

Model: ARXG09KSLAP

Outdoor temperature		Indoor temperature (°CDB)				
		16.0	18.0	20.0	22.0	24.0
(°CDB)	(°CWB)	TC	TC	TC	TC	TC
-15.0	-16.0	1.97	1.93	1.88	1.83	1.79
-10.0	-11.0	2.46	2.40	2.34	2.28	2.22
-5.0	-7.0	2.92	2.86	2.79	2.72	2.65
0.0	-2.0	3.44	3.36	3.28	3.19	3.11
5.0	3.0	3.78	3.69	3.60	3.51	3.42
7.0	6.0	3.78	3.69	3.60	3.51	3.42
10.0	8.0	3.78	3.69	3.60	3.51	3.42
15.0	10.0	3.78	3.69	3.60	3.51	3.42
20.0	15.0	3.78	3.69	3.60	3.51	3.42
24.0	18.0	3.78	3.69	3.60	3.51	3.42

Model: ARXG12KSLAP

Outdoor temperature		Indoor temperature (°CDB)				
		16.0	18.0	20.0	22.0	24.0
(°CDB)	(°CWB)	TC	TC	TC	TC	TC
-15.0	-16.0	2.63	2.57	2.51	2.44	2.38
-10.0	-11.0	3.28	3.20	3.12	3.04	2.97
-5.0	-7.0	3.90	3.81	3.71	3.62	3.53
0.0	-2.0	4.59	4.48	4.37	4.26	4.15
5.0	3.0	5.04	4.92	4.80	4.68	4.56
7.0	6.0	5.04	4.92	4.80	4.68	4.56
10.0	8.0	5.04	4.92	4.80	4.68	4.56
15.0	10.0	5.04	4.92	4.80	4.68	4.56
20.0	15.0	5.04	4.92	4.80	4.68	4.56
24.0	18.0	5.04	4.92	4.80	4.68	4.56

Model: ARXG14KSLAP

Outdoor temperature		Indoor temperature (°CDB)				
		16.0	18.0	20.0	22.0	24.0
(°CDB)	(°CWB)	TC	TC	TC	TC	TC
-15.0	-16.0	3.07	3.00	2.93	2.85	2.78
-10.0	-11.0	3.82	3.73	3.64	3.55	3.46
-5.0	-7.0	4.55	4.44	4.33	4.22	4.12
0.0	-2.0	5.35	5.22	5.10	4.97	4.84
5.0	3.0	5.88	5.74	5.60	5.46	5.32
7.0	6.0	5.88	5.74	5.60	5.46	5.32
10.0	8.0	5.88	5.74	5.60	5.46	5.32
15.0	10.0	5.88	5.74	5.60	5.46	5.32
20.0	15.0	5.88	5.74	5.60	5.46	5.32
24.0	18.0	5.88	5.74	5.60	5.46	5.32

Model: ARXG18KSLAP

Outdoor temperature		Indoor temperature (°CDB)				
		16.0	18.0	20.0	22.0	24.0
(°CDB)	(°CWB)	TC	TC	TC	TC	TC
-15.0	-16.0	3.69	3.60	3.51	3.42	3.33
-10.0	-11.0	4.59	4.48	4.37	4.26	4.15
-5.0	-7.0	5.46	5.33	5.20	5.07	4.94
0.0	-2.0	6.42	6.27	6.11	5.96	5.81
5.0	3.0	7.06	6.89	6.72	6.55	6.38
7.0	6.0	7.06	6.89	6.72	6.55	6.38
10.0	8.0	7.06	6.89	6.72	6.55	6.38
15.0	10.0	7.06	6.89	6.72	6.55	6.38
20.0	15.0	7.06	6.89	6.72	6.55	6.38
24.0	18.0	7.06	6.89	6.72	6.55	6.38

NOTES:

- TC: Total Capacity (kW)
- Values mentioned in the table are based on the following conditions:
 - Pipe length: 5 m, Height difference: 0 m [Outdoor unit—Indoor unit]

● Slim duct type

Model: ARXG07KLLAP

Outdoor temperature		Indoor temperature (°CDB)				
		16.0	18.0	20.0	22.0	24.0
(°CDB)	(°CWB)	TC	TC	TC	TC	TC
-15.0	-16.0	1.54	1.50	1.46	1.43	1.39
-10.0	-11.0	1.91	1.87	1.82	1.78	1.73
-5.0	-7.0	2.27	2.22	2.17	2.11	2.06
0.0	-2.0	2.68	2.61	2.55	2.48	2.42
5.0	3.0	2.94	2.87	2.80	2.73	2.66
7.0	6.0	2.94	2.87	2.80	2.73	2.66
10.0	8.0	2.94	2.87	2.80	2.73	2.66
15.0	10.0	2.94	2.87	2.80	2.73	2.66
20.0	15.0	2.94	2.87	2.80	2.73	2.66
24.0	18.0	2.94	2.87	2.80	2.73	2.66

Model: ARXG09KLLAP

Outdoor temperature		Indoor temperature (°CDB)				
		16.0	18.0	20.0	22.0	24.0
(°CDB)	(°CWB)	TC	TC	TC	TC	TC
-15.0	-16.0	1.97	1.93	1.88	1.83	1.79
-10.0	-11.0	2.46	2.40	2.34	2.28	2.22
-5.0	-7.0	2.92	2.86	2.79	2.72	2.65
0.0	-2.0	3.44	3.36	3.28	3.19	3.11
5.0	3.0	3.78	3.69	3.60	3.51	3.42
7.0	6.0	3.78	3.69	3.60	3.51	3.42
10.0	8.0	3.78	3.69	3.60	3.51	3.42
15.0	10.0	3.78	3.69	3.60	3.51	3.42
20.0	15.0	3.78	3.69	3.60	3.51	3.42
24.0	18.0	3.78	3.69	3.60	3.51	3.42

Model: ARXG12KLLAP

Outdoor temperature		Indoor temperature (°CDB)				
		16.0	18.0	20.0	22.0	24.0
(°CDB)	(°CWB)	TC	TC	TC	TC	TC
-15.0	-16.0	2.63	2.57	2.51	2.44	2.38
-10.0	-11.0	3.28	3.20	3.12	3.04	2.97
-5.0	-7.0	3.90	3.81	3.71	3.62	3.53
0.0	-2.0	4.59	4.48	4.37	4.26	4.15
5.0	3.0	5.04	4.92	4.80	4.68	4.56
7.0	6.0	5.04	4.92	4.80	4.68	4.56
10.0	8.0	5.04	4.92	4.80	4.68	4.56
15.0	10.0	5.04	4.92	4.80	4.68	4.56
20.0	15.0	5.04	4.92	4.80	4.68	4.56
24.0	18.0	5.04	4.92	4.80	4.68	4.56

Model: ARXG14KLLAP

Outdoor temperature		Indoor temperature (°CDB)				
		16.0	18.0	20.0	22.0	24.0
(°CDB)	(°CWB)	TC	TC	TC	TC	TC
-15.0	-16.0	3.07	3.00	2.93	2.85	2.78
-10.0	-11.0	3.82	3.73	3.64	3.55	3.46
-5.0	-7.0	4.55	4.44	4.33	4.22	4.12
0.0	-2.0	5.35	5.22	5.10	4.97	4.84
5.0	3.0	5.88	5.74	5.60	5.46	5.32
7.0	6.0	5.88	5.74	5.60	5.46	5.32
10.0	8.0	5.88	5.74	5.60	5.46	5.32
15.0	10.0	5.88	5.74	5.60	5.46	5.32
20.0	15.0	5.88	5.74	5.60	5.46	5.32
24.0	18.0	5.88	5.74	5.60	5.46	5.32

Model: ARXG18KLLAP

Outdoor temperature		Indoor temperature (°CDB)				
		16.0	18.0	20.0	22.0	24.0
(°CDB)	(°CWB)	TC	TC	TC	TC	TC
-15.0	-16.0	3.69	3.60	3.51	3.42	3.33
-10.0	-11.0	4.59	4.48	4.37	4.26	4.15
-5.0	-7.0	5.46	5.33	5.20	5.07	4.94
0.0	-2.0	6.42	6.27	6.11	5.96	5.81
5.0	3.0	7.06	6.89	6.72	6.55	6.38
7.0	6.0	7.06	6.89	6.72	6.55	6.38
10.0	8.0	7.06	6.89	6.72	6.55	6.38
15.0	10.0	7.06	6.89	6.72	6.55	6.38
20.0	15.0	7.06	6.89	6.72	6.55	6.38
24.0	18.0	7.06	6.89	6.72	6.55	6.38

NOTES:

- TC: Total Capacity (kW)
- Values mentioned in the table are based on the following conditions:
 - Pipe length: 5 m, Height difference: 0 m (Outdoor unit—Indoor unit)

● Medium static pressure duct type**Model: ARXG22KMLB**

Outdoor temperature		Indoor temperature (°CDB)				
		16.0	18.0	20.0	22.0	24.0
(°CDB)	(°CWB)	TC	TC	TC	TC	TC
-15.0	-16.0	4.66	4.55	4.44	4.33	4.22
-10.0	-11.0	5.80	5.67	5.53	5.39	5.25
-5.0	-7.0	6.91	6.74	6.58	6.41	6.25
0.0	-2.0	8.12	7.93	7.73	7.54	7.35
5.0	3.0	8.93	8.71	8.50	8.29	8.08
7.0	6.0	8.93	8.71	8.50	8.29	8.08
10.0	8.0	8.93	8.71	8.50	8.29	8.08
15.0	10.0	8.93	8.71	8.50	8.29	8.08
20.0	15.0	8.93	8.71	8.50	8.29	8.08
24.0	18.0	8.93	8.71	8.50	8.29	8.08

NOTES:

- TC: Total Capacity (kW)
- Values mentioned in the table are based on the following conditions:
 - Pipe length: 5 m, Height difference: 0 m (Outdoor unit—Indoor unit)

● Wall mounted type

Model: ASYG07KGTB

Outdoor temperature		Indoor temperature (°CDB)				
		16.0	18.0	20.0	22.0	24.0
(°CDB)	(°CWB)	TC	TC	TC	TC	TC
-15.0	-16.0	1.54	1.50	1.46	1.43	1.39
-10.0	-11.0	1.91	1.87	1.82	1.78	1.73
-5.0	-7.0	2.27	2.22	2.17	2.11	2.06
0.0	-2.0	2.68	2.61	2.55	2.48	2.42
5.0	3.0	2.94	2.87	2.80	2.73	2.66
7.0	6.0	2.94	2.87	2.80	2.73	2.66
10.0	8.0	2.94	2.87	2.80	2.73	2.66
15.0	10.0	2.94	2.87	2.80	2.73	2.66
20.0	15.0	2.94	2.87	2.80	2.73	2.66
24.0	18.0	2.94	2.87	2.80	2.73	2.66

OUTDOOR UNIT
AOYG30KETA4OUTDOOR UNIT
AOYG30KETA4

Model: ASYG09KGTB

Outdoor temperature		Indoor temperature (°CDB)				
		16.0	18.0	20.0	22.0	24.0
(°CDB)	(°CWB)	TC	TC	TC	TC	TC
-15.0	-16.0	1.97	1.93	1.88	1.83	1.79
-10.0	-11.0	2.46	2.40	2.34	2.28	2.22
-5.0	-7.0	2.92	2.86	2.79	2.72	2.65
0.0	-2.0	3.44	3.36	3.28	3.19	3.11
5.0	3.0	3.78	3.69	3.60	3.51	3.42
7.0	6.0	3.78	3.69	3.60	3.51	3.42
10.0	8.0	3.78	3.69	3.60	3.51	3.42
15.0	10.0	3.78	3.69	3.60	3.51	3.42
20.0	15.0	3.78	3.69	3.60	3.51	3.42
24.0	18.0	3.78	3.69	3.60	3.51	3.42

Model: ASYG12KGTB

Outdoor temperature		Indoor temperature (°CDB)				
		16.0	18.0	20.0	22.0	24.0
(°CDB)	(°CWB)	TC	TC	TC	TC	TC
-15.0	-16.0	2.63	2.57	2.51	2.44	2.38
-10.0	-11.0	3.28	3.20	3.12	3.04	2.97
-5.0	-7.0	3.90	3.81	3.71	3.62	3.53
0.0	-2.0	4.59	4.48	4.37	4.26	4.15
5.0	3.0	5.04	4.92	4.80	4.68	4.56
7.0	6.0	5.04	4.92	4.80	4.68	4.56
10.0	8.0	5.04	4.92	4.80	4.68	4.56
15.0	10.0	5.04	4.92	4.80	4.68	4.56
20.0	15.0	5.04	4.92	4.80	4.68	4.56
24.0	18.0	5.04	4.92	4.80	4.68	4.56

Model: ASYG14KGTB

Outdoor temperature		Indoor temperature (°CDB)				
		16.0	18.0	20.0	22.0	24.0
(°CDB)	(°CWB)	TC	TC	TC	TC	TC
-15.0	-16.0	3.07	3.00	2.93	2.85	2.78
-10.0	-11.0	3.82	3.73	3.64	3.55	3.46
-5.0	-7.0	4.55	4.44	4.33	4.22	4.12
0.0	-2.0	5.35	5.22	5.10	4.97	4.84
5.0	3.0	5.88	5.74	5.60	5.46	5.32
7.0	6.0	5.88	5.74	5.60	5.46	5.32
10.0	8.0	5.88	5.74	5.60	5.46	5.32
15.0	10.0	5.88	5.74	5.60	5.46	5.32
20.0	15.0	5.88	5.74	5.60	5.46	5.32
24.0	18.0	5.88	5.74	5.60	5.46	5.32

Model: ASYG18KMTB

Outdoor temperature		Indoor temperature (°CDB)				
		16.0	18.0	20.0	22.0	24.0
(°CDB)	(°CWB)	TC	TC	TC	TC	TC
-15.0	-16.0	3.69	3.60	3.51	3.42	3.33
-10.0	-11.0	4.59	4.48	4.37	4.26	4.15
-5.0	-7.0	5.46	5.33	5.20	5.07	4.94
0.0	-2.0	6.42	6.27	6.11	5.96	5.81
5.0	3.0	7.06	6.89	6.72	6.55	6.38
7.0	6.0	7.06	6.89	6.72	6.55	6.38
10.0	8.0	7.06	6.89	6.72	6.55	6.38
15.0	10.0	7.06	6.89	6.72	6.55	6.38
20.0	15.0	7.06	6.89	6.72	6.55	6.38
24.0	18.0	7.06	6.89	6.72	6.55	6.38

Model: ASYG22KMTB

Outdoor temperature		Indoor temperature (°CDB)				
		16.0	18.0	20.0	22.0	24.0
(°CDB)	(°CWB)	TC	TC	TC	TC	TC
-15.0	-16.0	4.66	4.55	4.44	4.33	4.22
-10.0	-11.0	5.80	5.67	5.53	5.39	5.25
-5.0	-7.0	6.91	6.74	6.58	6.41	6.25
0.0	-2.0	8.12	7.93	7.73	7.54	7.35
5.0	3.0	8.93	8.71	8.50	8.29	8.08
7.0	6.0	8.93	8.71	8.50	8.29	8.08
10.0	8.0	8.93	8.71	8.50	8.29	8.08
15.0	10.0	8.93	8.71	8.50	8.29	8.08
20.0	15.0	8.93	8.71	8.50	8.29	8.08
24.0	18.0	8.93	8.71	8.50	8.29	8.08

Model: ASYG24KMTB

Outdoor temperature		Indoor temperature (°CDB)				
		16.0	18.0	20.0	22.0	24.0
(°CDB)	(°CWB)	TC	TC	TC	TC	TC
-15.0	-16.0	4.76	4.64	4.53	4.42	4.30
-10.0	-11.0	5.92	5.78	5.64	5.50	5.36
-5.0	-7.0	7.04	6.88	6.71	6.54	6.37
0.0	-2.0	8.28	8.09	7.89	7.69	7.49
5.0	3.0	9.10	8.89	8.67	8.45	8.24
7.0	6.0	9.10	8.89	8.67	8.45	8.24
10.0	8.0	9.10	8.89	8.67	8.45	8.24
15.0	10.0	9.10	8.89	8.67	8.45	8.24
20.0	15.0	9.10	8.89	8.67	8.45	8.24
24.0	18.0	9.10	8.89	8.67	8.45	8.24

Model: ASYG07KMTB

Outdoor temperature		Indoor temperature (°CDB)				
		16.0	18.0	20.0	22.0	24.0
(°CDB)	(°CWB)	TC	TC	TC	TC	TC
-15.0	-16.0	1.54	1.50	1.46	1.43	1.39
-10.0	-11.0	1.91	1.87	1.82	1.78	1.73
-5.0	-7.0	2.27	2.22	2.17	2.11	2.06
0.0	-2.0	2.68	2.61	2.55	2.48	2.42
5.0	3.0	2.94	2.87	2.80	2.73	2.66
7.0	6.0	2.94	2.87	2.80	2.73	2.66
10.0	8.0	2.94	2.87	2.80	2.73	2.66
15.0	10.0	2.94	2.87	2.80	2.73	2.66
20.0	15.0	2.94	2.87	2.80	2.73	2.66
24.0	18.0	2.94	2.87	2.80	2.73	2.66

Model: ASYG09KMTB

Outdoor temperature		Indoor temperature (°CDB)				
		16.0	18.0	20.0	22.0	24.0
(°CDB)	(°CWB)	TC	TC	TC	TC	TC
-15.0	-16.0	1.97	1.93	1.88	1.83	1.79
-10.0	-11.0	2.46	2.40	2.34	2.28	2.22
-5.0	-7.0	2.92	2.86	2.79	2.72	2.65
0.0	-2.0	3.44	3.36	3.28	3.19	3.11
5.0	3.0	3.78	3.69	3.60	3.51	3.42
7.0	6.0	3.78	3.69	3.60	3.51	3.42
10.0	8.0	3.78	3.69	3.60	3.51	3.42
15.0	10.0	3.78	3.69	3.60	3.51	3.42
20.0	15.0	3.78	3.69	3.60	3.51	3.42
24.0	18.0	3.78	3.69	3.60	3.51	3.42

Model: ASYG12KMTB

Outdoor temperature		Indoor temperature (°CDB)				
		16.0	18.0	20.0	22.0	24.0
(°CDB)	(°CWB)	TC	TC	TC	TC	TC
-15.0	-16.0	2.63	2.57	2.51	2.44	2.38
-10.0	-11.0	3.28	3.20	3.12	3.04	2.97
-5.0	-7.0	3.90	3.81	3.71	3.62	3.53
0.0	-2.0	4.59	4.48	4.37	4.26	4.15
5.0	3.0	5.04	4.92	4.80	4.68	4.56
7.0	6.0	5.04	4.92	4.80	4.68	4.56
10.0	8.0	5.04	4.92	4.80	4.68	4.56
15.0	10.0	5.04	4.92	4.80	4.68	4.56
20.0	15.0	5.04	4.92	4.80	4.68	4.56
24.0	18.0	5.04	4.92	4.80	4.68	4.56

Model: ASYG14KMTB

Outdoor temperature		Indoor temperature (°CDB)				
		16.0	18.0	20.0	22.0	24.0
(°CDB)	(°CWB)	TC	TC	TC	TC	TC
-15.0	-16.0	3.07	3.00	2.93	2.85	2.78
-10.0	-11.0	3.82	3.73	3.64	3.55	3.46
-5.0	-7.0	4.55	4.44	4.33	4.22	4.12
0.0	-2.0	5.35	5.22	5.10	4.97	4.84
5.0	3.0	5.88	5.74	5.60	5.46	5.32
7.0	6.0	5.88	5.74	5.60	5.46	5.32
10.0	8.0	5.88	5.74	5.60	5.46	5.32
15.0	10.0	5.88	5.74	5.60	5.46	5.32
20.0	15.0	5.88	5.74	5.60	5.46	5.32
24.0	18.0	5.88	5.74	5.60	5.46	5.32

Model: ASYG07KMCC

Outdoor temperature		Indoor temperature (°CDB)				
		16.0	18.0	20.0	22.0	24.0
(°CDB)	(°CWB)	TC	TC	TC	TC	TC
-15.0	-16.0	1.54	1.50	1.46	1.43	1.39
-10.0	-11.0	1.91	1.87	1.82	1.78	1.73
-5.0	-7.0	2.27	2.22	2.17	2.11	2.06
0.0	-2.0	2.68	2.61	2.55	2.48	2.42
5.0	3.0	2.94	2.87	2.80	2.73	2.66
7.0	6.0	2.94	2.87	2.80	2.73	2.66
10.0	8.0	2.94	2.87	2.80	2.73	2.66
15.0	10.0	2.94	2.87	2.80	2.73	2.66
20.0	15.0	2.94	2.87	2.80	2.73	2.66
24.0	18.0	2.94	2.87	2.80	2.73	2.66

Model: ASYG09KMCC

Outdoor temperature		Indoor temperature (°CDB)				
		16.0	18.0	20.0	22.0	24.0
(°CDB)	(°CWB)	TC	TC	TC	TC	TC
-15.0	-16.0	1.97	1.93	1.88	1.83	1.79
-10.0	-11.0	2.46	2.40	2.34	2.28	2.22
-5.0	-7.0	2.92	2.86	2.79	2.72	2.65
0.0	-2.0	3.44	3.36	3.28	3.19	3.11
5.0	3.0	3.78	3.69	3.60	3.51	3.42
7.0	6.0	3.78	3.69	3.60	3.51	3.42
10.0	8.0	3.78	3.69	3.60	3.51	3.42
15.0	10.0	3.78	3.69	3.60	3.51	3.42
20.0	15.0	3.78	3.69	3.60	3.51	3.42
24.0	18.0	3.78	3.69	3.60	3.51	3.42

Model: ASYG12KMCC

Outdoor temperature		Indoor temperature (°CDB)				
		16.0	18.0	20.0	22.0	24.0
(°CDB)	(°CWB)	TC	TC	TC	TC	TC
-15.0	-16.0	2.63	2.57	2.51	2.44	2.38
-10.0	-11.0	3.28	3.20	3.12	3.04	2.97
-5.0	-7.0	3.90	3.81	3.71	3.62	3.53
0.0	-2.0	4.59	4.48	4.37	4.26	4.15
5.0	3.0	5.04	4.92	4.80	4.68	4.56
7.0	6.0	5.04	4.92	4.80	4.68	4.56
10.0	8.0	5.04	4.92	4.80	4.68	4.56
15.0	10.0	5.04	4.92	4.80	4.68	4.56
20.0	15.0	5.04	4.92	4.80	4.68	4.56
24.0	18.0	5.04	4.92	4.80	4.68	4.56

Model: ASYG14KMCC

Outdoor temperature		Indoor temperature (°CDB)				
		16.0	18.0	20.0	22.0	24.0
(°CDB)	(°CWB)	TC	TC	TC	TC	TC
-15.0	-16.0	3.07	3.00	2.93	2.85	2.78
-10.0	-11.0	3.82	3.73	3.64	3.55	3.46
-5.0	-7.0	4.55	4.44	4.33	4.22	4.12
0.0	-2.0	5.35	5.22	5.10	4.97	4.84
5.0	3.0	5.88	5.74	5.60	5.46	5.32
7.0	6.0	5.88	5.74	5.60	5.46	5.32
10.0	8.0	5.88	5.74	5.60	5.46	5.32
15.0	10.0	5.88	5.74	5.60	5.46	5.32
20.0	15.0	5.88	5.74	5.60	5.46	5.32
24.0	18.0	5.88	5.74	5.60	5.46	5.32

Model: ASYG07KETA, ASYG07KETA-B

Outdoor temperature		Indoor temperature (°CDB)				
		16.0	18.0	20.0	22.0	24.0
(°CDB)	(°CWB)	TC	TC	TC	TC	TC
-15.0	-16.0	1.54	1.50	1.46	1.43	1.39
-10.0	-11.0	1.91	1.87	1.82	1.78	1.73
-5.0	-7.0	2.27	2.22	2.17	2.11	2.06
0.0	-2.0	2.68	2.61	2.55	2.48	2.42
5.0	3.0	2.94	2.87	2.80	2.73	2.66
7.0	6.0	2.94	2.87	2.80	2.73	2.66
10.0	8.0	2.94	2.87	2.80	2.73	2.66
15.0	10.0	2.94	2.87	2.80	2.73	2.66
20.0	15.0	2.94	2.87	2.80	2.73	2.66
24.0	18.0	2.94	2.87	2.80	2.73	2.66

Model: ASYG09KETA, ASYG09KETA-B

Outdoor temperature		Indoor temperature (°CDB)				
		16.0	18.0	20.0	22.0	24.0
(°CDB)	(°CWB)	TC	TC	TC	TC	TC
-15.0	-16.0	1.97	1.93	1.88	1.83	1.79
-10.0	-11.0	2.46	2.40	2.34	2.28	2.22
-5.0	-7.0	2.92	2.86	2.79	2.72	2.65
0.0	-2.0	3.44	3.36	3.28	3.19	3.11
5.0	3.0	3.78	3.69	3.60	3.51	3.42
7.0	6.0	3.78	3.69	3.60	3.51	3.42
10.0	8.0	3.78	3.69	3.60	3.51	3.42
15.0	10.0	3.78	3.69	3.60	3.51	3.42
20.0	15.0	3.78	3.69	3.60	3.51	3.42
24.0	18.0	3.78	3.69	3.60	3.51	3.42

Model: ASYG12KETA, ASYG12KETA-B

Outdoor temperature		Indoor temperature (°CDB)				
		16.0	18.0	20.0	22.0	24.0
(°CDB)	(°CWB)	TC	TC	TC	TC	TC
-15.0	-16.0	2.63	2.57	2.51	2.44	2.38
-10.0	-11.0	3.28	3.20	3.12	3.04	2.97
-5.0	-7.0	3.90	3.81	3.71	3.62	3.53
0.0	-2.0	4.59	4.48	4.37	4.26	4.15
5.0	3.0	5.04	4.92	4.80	4.68	4.56
7.0	6.0	5.04	4.92	4.80	4.68	4.56
10.0	8.0	5.04	4.92	4.80	4.68	4.56
15.0	10.0	5.04	4.92	4.80	4.68	4.56
20.0	15.0	5.04	4.92	4.80	4.68	4.56
24.0	18.0	5.04	4.92	4.80	4.68	4.56

Model: ASYG14KETA, ASYG14KETA-B

Outdoor temperature		Indoor temperature (°CDB)				
		16.0	18.0	20.0	22.0	24.0
(°CDB)	(°CWB)	TC	TC	TC	TC	TC
-15.0	-16.0	3.07	3.00	2.93	2.85	2.78
-10.0	-11.0	3.82	3.73	3.64	3.55	3.46
-5.0	-7.0	4.55	4.44	4.33	4.22	4.12
0.0	-2.0	5.35	5.22	5.10	4.97	4.84
5.0	3.0	5.88	5.74	5.60	5.46	5.32
7.0	6.0	5.88	5.74	5.60	5.46	5.32
10.0	8.0	5.88	5.74	5.60	5.46	5.32
15.0	10.0	5.88	5.74	5.60	5.46	5.32
20.0	15.0	5.88	5.74	5.60	5.46	5.32
24.0	18.0	5.88	5.74	5.60	5.46	5.32

NOTES:

- TC: Total Capacity (kW)
- Values mentioned in the table are based on the following conditions:
 - Pipe length: 5 m, Height difference: 0 m (Outdoor unit—Indoor unit)

● Ceiling type

Model: ABYG18KRTA

Outdoor temperature		Indoor temperature (°CDB)				
		16.0	18.0	20.0	22.0	24.0
(°CDB)	(°CWB)	TC	TC	TC	TC	TC
-15.0	-16.0	3.69	3.60	3.51	3.42	3.33
-10.0	-11.0	4.59	4.48	4.37	4.26	4.15
-5.0	-7.0	5.46	5.33	5.20	5.07	4.94
0.0	-2.0	6.42	6.27	6.11	5.96	5.81
5.0	3.0	7.06	6.89	6.72	6.55	6.38
7.0	6.0	7.06	6.89	6.72	6.55	6.38
10.0	8.0	7.06	6.89	6.72	6.55	6.38
15.0	10.0	7.06	6.89	6.72	6.55	6.38
20.0	15.0	7.06	6.89	6.72	6.55	6.38
24.0	18.0	7.06	6.89	6.72	6.55	6.38

Model: ABYG22KRTA

Outdoor temperature		Indoor temperature (°CDB)				
		16.0	18.0	20.0	22.0	24.0
(°CDB)	(°CWB)	TC	TC	TC	TC	TC
-15.0	-16.0	4.66	4.55	4.44	4.33	4.22
-10.0	-11.0	5.80	5.67	5.53	5.39	5.25
-5.0	-7.0	6.91	6.74	6.58	6.41	6.25
0.0	-2.0	8.12	7.93	7.73	7.54	7.35
5.0	3.0	8.93	8.71	8.50	8.29	8.08
7.0	6.0	8.93	8.71	8.50	8.29	8.08
10.0	8.0	8.93	8.71	8.50	8.29	8.08
15.0	10.0	8.93	8.71	8.50	8.29	8.08
20.0	15.0	8.93	8.71	8.50	8.29	8.08
24.0	18.0	8.93	8.71	8.50	8.29	8.08

NOTES:

- TC: Total Capacity (kW)
- Values mentioned in the table are based on the following conditions:
 - Pipe length: 5 m, Height difference: 0 m (Outdoor unit—Indoor unit)

● Floor type

Model: AGYG09KVCA

Outdoor temperature		Indoor temperature (°CDB)				
		16.0	18.0	20.0	22.0	24.0
(°CDB)	(°CWB)	TC	TC	TC	TC	TC
-15.0	-16.0	1.97	1.93	1.88	1.83	1.79
-10.0	-11.0	2.46	2.40	2.34	2.28	2.22
-5.0	-7.0	2.92	2.86	2.79	2.72	2.65
0.0	-2.0	3.44	3.36	3.28	3.19	3.11
5.0	3.0	3.78	3.69	3.60	3.51	3.42
7.0	6.0	3.78	3.69	3.60	3.51	3.42
10.0	8.0	3.78	3.69	3.60	3.51	3.42
15.0	10.0	3.78	3.69	3.60	3.51	3.42
20.0	15.0	3.78	3.69	3.60	3.51	3.42
24.0	18.0	3.78	3.69	3.60	3.51	3.42

Model: AGYG12KVCA

Outdoor temperature		Indoor temperature (°CDB)				
		16.0	18.0	20.0	22.0	24.0
(°CDB)	(°CWB)	TC	TC	TC	TC	TC
-15.0	-16.0	2.63	2.57	2.51	2.44	2.38
-10.0	-11.0	3.28	3.20	3.12	3.04	2.97
-5.0	-7.0	3.90	3.81	3.71	3.62	3.53
0.0	-2.0	4.59	4.48	4.37	4.26	4.15
5.0	3.0	5.04	4.92	4.80	4.68	4.56
7.0	6.0	5.04	4.92	4.80	4.68	4.56
10.0	8.0	5.04	4.92	4.80	4.68	4.56
15.0	10.0	5.04	4.92	4.80	4.68	4.56
20.0	15.0	5.04	4.92	4.80	4.68	4.56
24.0	18.0	5.04	4.92	4.80	4.68	4.56

Model: AGYG14KVCA

Outdoor temperature		Indoor temperature (°CDB)				
		16.0	18.0	20.0	22.0	24.0
(°CDB)	(°CWB)	TC	TC	TC	TC	TC
-15.0	-16.0	3.07	3.00	2.93	2.85	2.78
-10.0	-11.0	3.82	3.73	3.64	3.55	3.46
-5.0	-7.0	4.55	4.44	4.33	4.22	4.12
0.0	-2.0	5.35	5.22	5.10	4.97	4.84
5.0	3.0	5.88	5.74	5.60	5.46	5.32
7.0	6.0	5.88	5.74	5.60	5.46	5.32
10.0	8.0	5.88	5.74	5.60	5.46	5.32
15.0	10.0	5.88	5.74	5.60	5.46	5.32
20.0	15.0	5.88	5.74	5.60	5.46	5.32
24.0	18.0	5.88	5.74	5.60	5.46	5.32

NOTES:

- TC: Total Capacity (kW)
- Values mentioned in the table are based on the following conditions:
 - Pipe length: 5 m, Height difference: 0 m (Outdoor unit—Indoor unit)

7. Capacity compensation rate for pipe length and height difference

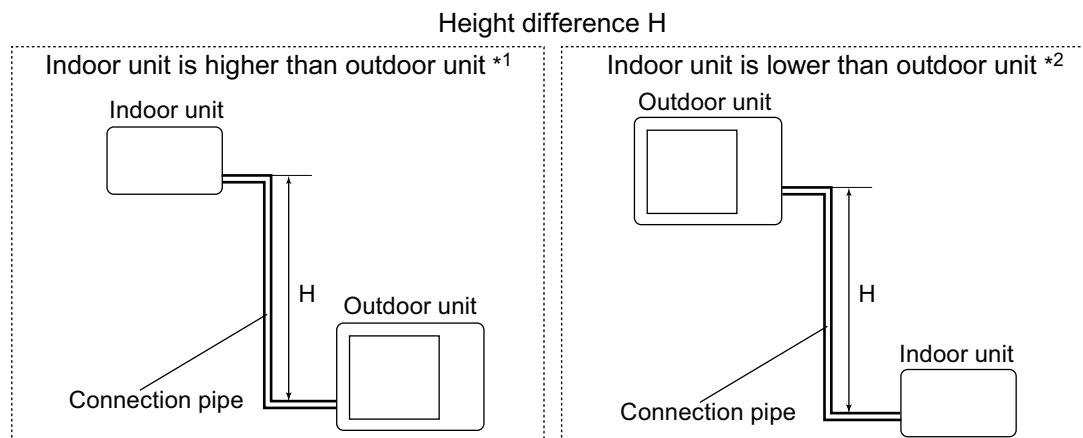

7-1. Model: AOYG30KBTA4

NOTE: Values mentioned in the table are calculated based on the maximum capacity.

■ Indoor unit: 7,000 Btu/h

Cooling		Pipe length						
		m	2.5	5	10	15	20	25
Height difference H (m)	Indoor unit is higher than outdoor unit *1	15	—	—	—	0.955	0.941	0.927
		10	—	—	0.976	0.962	0.949	0.935
		5	—	0.992	0.984	0.970	0.956	0.942
		2.5	0.999	0.996	0.988	0.974	0.960	0.946
	Indoor unit is lower than outdoor unit *2	0	1.003	1.000	0.992	0.978	0.964	0.950
		-2.5	1.003	1.000	0.992	0.978	0.964	0.950
		-5	—	1.000	0.992	0.978	0.964	0.950
		-10	—	—	0.992	0.978	0.964	0.950
		-15	—	—	—	0.978	0.964	0.950

Heating		Pipe length						
		m	2.5	5	10	15	20	25
Height difference H (m)	Indoor unit is higher than outdoor unit *1	15	—	—	—	0.976	0.957	0.938
		10	—	—	0.991	0.976	0.957	0.938
		5	—	1.000	0.991	0.976	0.957	0.938
		2.5	0.990	1.000	0.991	0.976	0.957	0.938
	Indoor unit is lower than outdoor unit *2	0	0.990	1.000	0.991	0.976	0.957	0.938
		-2.5	0.988	0.997	0.989	0.974	0.955	0.936
		-5	—	0.995	0.986	0.971	0.952	0.933
		-10	—	—	0.981	0.966	0.947	0.929
		-15	—	—	—	0.961	0.943	0.924

■ Indoor unit: 9,000 Btu/h

Cooling		Pipe length						
		m	2.5	5	10	15	20	25
Height difference H (m)	Indoor unit is higher than outdoor unit *1	15	—	—	—	0.956	0.942	0.928
		10	—	—	0.977	0.963	0.950	0.936
		5	—	0.992	0.985	0.971	0.957	0.943
		2.5	1.003	0.996	0.989	0.975	0.961	0.947
	Indoor unit is lower than outdoor unit *2	0	1.007	1.000	0.993	0.979	0.965	0.951
		-2.5	1.007	1.000	0.993	0.979	0.965	0.951
		-5	—	1.000	0.993	0.979	0.965	0.951
		-10	—	—	0.993	0.979	0.965	0.951
		-15	—	—	—	0.979	0.965	0.951

Heating		Pipe length						
		m	2.5	5	10	15	20	25
Height difference H (m)	Indoor unit is higher than outdoor unit *1	15	—	—	—	0.977	0.958	0.939
		10	—	—	0.993	0.977	0.958	0.939
		5	—	1.000	0.993	0.977	0.958	0.939
		2.5	0.993	1.000	0.993	0.977	0.958	0.939
	Indoor unit is lower than outdoor unit *2	0	0.993	1.000	0.993	0.977	0.958	0.939
		-2.5	0.991	0.997	0.991	0.975	0.956	0.937
		-5	—	0.995	0.988	0.972	0.954	0.934
		-10	—	—	0.983	0.967	0.949	0.930
		-15	—	—	—	0.962	0.944	0.925

■ Indoor unit: 12,000 Btu/h

Cooling		Pipe length						
		m	2.5	5	10	15	20	25
Height difference H (m)	Indoor unit is higher than outdoor unit *1	15	—	—	—	0.937	0.912	0.888
		10	—	—	0.970	0.944	0.919	0.896
		5	—	0.992	0.978	0.952	0.927	0.903
		2.5	1.010	0.996	0.982	0.956	0.930	0.907
	Indoor unit is lower than outdoor unit *2	0	1.014	1.000	0.986	0.960	0.934	0.910
		-2.5	1.014	1.000	0.986	0.960	0.934	0.910
		-5	—	1.000	0.986	0.960	0.934	0.910
		-10	—	—	0.986	0.960	0.934	0.910
		-15	—	—	—	0.960	0.934	0.910

Heating		Pipe length						
		m	2.5	5	10	15	20	25
Height difference H (m)	Indoor unit is higher than outdoor unit *1	15	—	—	—	0.977	0.958	0.938
		10	—	—	0.993	0.977	0.958	0.938
		5	—	1.000	0.993	0.977	0.958	0.938
		2.5	0.995	1.000	0.993	0.977	0.958	0.938
	Indoor unit is lower than outdoor unit *2	0	0.995	1.000	0.993	0.977	0.958	0.938
		-2.5	0.993	0.997	0.991	0.975	0.956	0.936
		-5	—	0.995	0.988	0.972	0.953	0.933
		-10	—	—	0.983	0.967	0.949	0.929
		-15	—	—	—	0.962	0.944	0.924

■ Indoor unit: 14,000 Btu/h

Cooling		Pipe length						
		m	2.5	5	10	15	20	25
Height difference H (m)	Indoor unit is higher than outdoor unit *1	15	—	—	—	0.955	0.937	0.922
		10	—	—	0.974	0.962	0.945	0.930
		5	—	0.992	0.982	0.970	0.952	0.937
		2.5	0.999	0.996	0.986	0.974	0.956	0.941
	Indoor unit is lower than outdoor unit *2	0	1.005	1.000	0.990	0.978	0.960	0.945
		-2.5	1.005	1.000	0.990	0.978	0.960	0.945
		-5	—	1.000	0.990	0.978	0.960	0.945
		-10	—	—	0.990	0.978	0.960	0.945
		-15	—	—	—	0.978	0.960	0.945

Heating		Pipe length						
		m	2.5	5	10	15	20	25
Height difference H (m)	Indoor unit is higher than outdoor unit *1	15	—	—	—	0.972	0.945	0.919
		10	—	—	0.992	0.972	0.945	0.919
		5	—	1.000	0.992	0.972	0.945	0.919
		2.5	1.000	1.000	0.992	0.972	0.945	0.919
	Indoor unit is lower than outdoor unit *2	0	1.000	1.000	0.992	0.972	0.945	0.919
		-2.5	0.998	0.997	0.990	0.970	0.943	0.917
		-5	—	0.995	0.987	0.967	0.940	0.914
		-10	—	—	0.982	0.962	0.935	0.910
		-15	—	—	—	0.957	0.930	0.905

■ Indoor unit: 18,000 Btu/h

Cooling		Pipe length						
		m	2.5	5	10	15	20	25
Height difference H (m)	Indoor unit is higher than outdoor unit *1	15	—	—	—	0.968	0.961	0.954
		10	—	—	0.982	0.976	0.969	0.962
		5	—	0.992	0.990	0.984	0.977	0.970
		2.5	0.998	0.996	0.994	0.988	0.981	0.974
	Indoor unit is lower than outdoor unit *2	0	1.002	1.000	0.998	0.992	0.985	0.978
		-2.5	1.002	1.000	0.998	0.992	0.985	0.978
		-5	—	1.000	0.998	0.992	0.985	0.978
		-10	—	—	0.998	0.992	0.985	0.978
		-15	—	—	—	0.992	0.985	0.978

Heating		Pipe length						
		m	2.5	5	10	15	20	25
Height difference H (m)	Indoor unit is higher than outdoor unit *1	15	—	—	—	0.967	0.943	0.917
		10	—	—	0.990	0.967	0.943	0.917
		5	—	1.000	0.990	0.967	0.943	0.917
		2.5	1.010	1.000	0.990	0.967	0.943	0.917
	Indoor unit is lower than outdoor unit *2	0	1.010	1.000	0.990	0.967	0.943	0.917
		-2.5	1.008	0.997	0.988	0.965	0.941	0.915
		-5	—	0.995	0.985	0.962	0.938	0.912
		-10	—	—	0.980	0.958	0.933	0.908
		-15	—	—	—	0.953	0.929	0.903

Indoor unit: 22,000 Btu/h

Cooling		Pipe length						
		m	2.5	5	10	15	20	25
Height difference H (m)	Indoor unit is higher than outdoor unit *1	15	—	—	—	0.978	0.969	0.953
		10	—	—	0.986	0.986	0.977	0.961
		5	—	0.992	0.994	0.994	0.984	0.968
		2.5	0.993	0.996	0.998	0.998	0.988	0.972
	Indoor unit is lower than outdoor unit *2	0	0.997	1.000	1.002	1.002	0.992	0.976
		-2.5	0.997	1.000	1.002	1.002	0.992	0.976
		-5	—	1.000	1.002	1.002	0.992	0.976
		-10	—	—	1.002	1.002	0.992	0.976
		-15	—	—	—	1.002	0.992	0.976

Heating		Pipe length						
		m	2.5	5	10	15	20	25
Height difference H (m)	Indoor unit is higher than outdoor unit *1	15	—	—	—	0.964	0.939	0.913
		10	—	—	0.988	0.964	0.939	0.913
		5	—	1.000	0.988	0.964	0.939	0.913
		2.5	1.008	1.000	0.988	0.964	0.939	0.913
	Indoor unit is lower than outdoor unit *2	0	1.008	1.000	0.988	0.964	0.939	0.913
		-2.5	1.006	0.997	0.986	0.962	0.937	0.911
		-5	—	0.995	0.983	0.959	0.934	0.909
		-10	—	—	0.978	0.954	0.929	0.904
		-15	—	—	—	0.949	0.925	0.899

Indoor unit: 24,000 Btu/h

Cooling		Pipe length						
		m	2.5	5	10	15	20	25
Height difference H (m)	Indoor unit is higher than outdoor unit *1	15	—	—	—	0.978	0.969	0.953
		10	—	—	0.986	0.986	0.977	0.961
		5	—	0.992	0.994	0.994	0.984	0.968
		2.5	0.993	0.996	0.998	0.998	0.988	0.972
	Indoor unit is lower than outdoor unit *2	0	0.997	1.000	1.002	1.002	0.992	0.976
		-2.5	0.997	1.000	1.002	1.002	0.992	0.976
		-5	—	1.000	1.002	1.002	0.992	0.976
		-10	—	—	1.002	1.002	0.992	0.976
		-15	—	—	—	1.002	0.992	0.976

Heating		Pipe length						
		m	2.5	5	10	15	20	25
Height difference H (m)	Indoor unit is higher than outdoor unit *1	15	—	—	—	0.964	0.939	0.913
		10	—	—	0.988	0.964	0.939	0.913
		5	—	1.000	0.988	0.964	0.939	0.913
		2.5	1.008	1.000	0.988	0.964	0.939	0.913
	Indoor unit is lower than outdoor unit *2	0	1.008	1.000	0.988	0.964	0.939	0.913
		-2.5	1.006	0.997	0.986	0.962	0.937	0.911
		-5	—	0.995	0.983	0.959	0.934	0.909
		-10	—	—	0.978	0.954	0.929	0.904
		-15	—	—	—	0.949	0.925	0.899

8. Additional charge calculation

8-1. Model: AOYG30KBTA4

Refrigerant type		R32
Refrigerant amount	g	2,200

Refrigerant charge						
Total pipe length	m	40 or less	50	60	70 (Max.)	20 g/m
Additional charge amount	g	0	200	400	600	

9. Airflow

9-1. Model: AOYG30KBTA4

● Cooling

m ³ /h	2,400
l/s	667
CFM	1,413

● Heating

m ³ /h	2,950
l/s	820
CFM	1,736

10. Operation noise (sound pressure)

10-1. Noise level curve

Model: AOYG30KBTA4

● Cooling

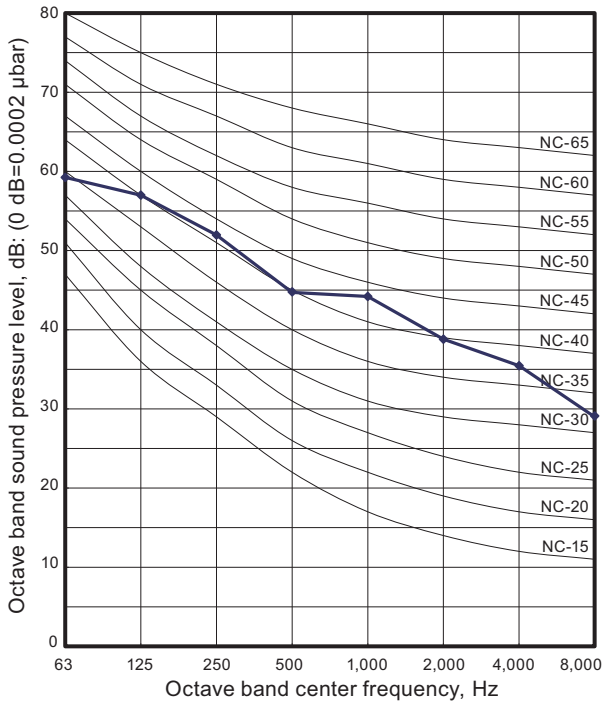

● Heating

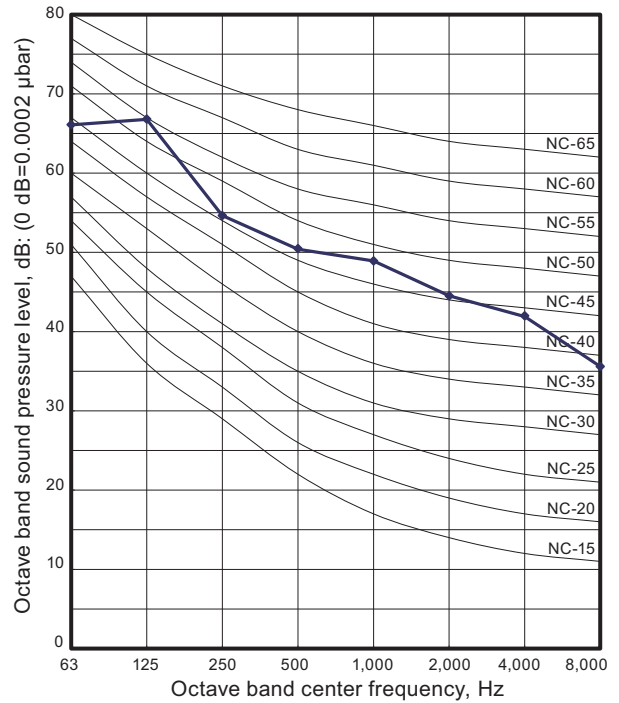

10-2. Sound level check point

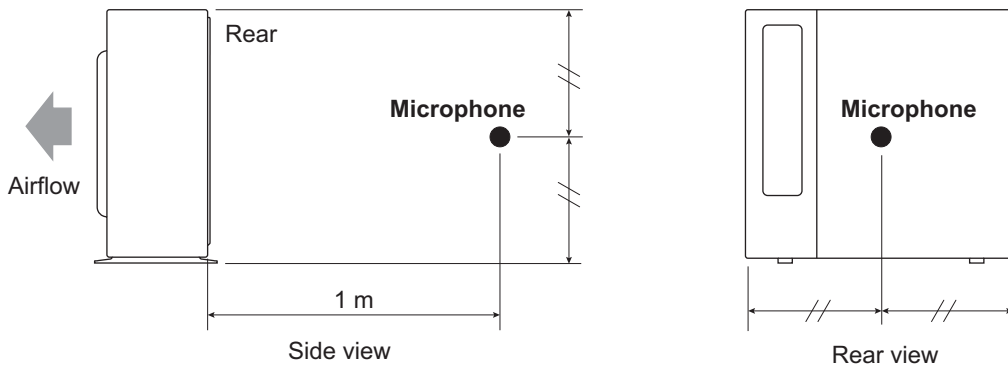

NOTE: Detailed shape of the actual outdoor unit might be slightly different from the one illustrated above.

11. Electrical characteristics

Model name			AOYG30KBTA4	
Power supply	Voltage	V	230 ~	
	Frequency	Hz	50	
Maximum operating current *1		A	18.5	
Starting current		A	9.4	
Wiring spec. *2	Main fuse (Circuit breaker) current		A	
	Power cable		mm ²	
	Connection cable *3	Cross-sectional area		1.5
		Limited wiring length	m	26

*1: Maximum operating current is the total current of the indoor unit and the outdoor unit.

*2: Selected sample based on Japan Electrotechnical Standards and Codes Committee E0005. As the regulations of wire size and circuit breaker differ in each country or region, select appropriate devices complied to the regional standard.

*3: This is the wiring length in case voltage descent is less than 2%. When the wiring length becomes longer, select the wiring of a more larger diameter.

12. Safety devices

Type of protection	Protection form		Model
			AOYG30KBTA4
Circuit protection	Current fuse (Main PCB)		250 V, 5 A 250 V, 20 A 250 V, 3.15 A
Fan motor protection	Thermal protector	Activate	125 ±10 °C Fan motor stop
		Reset	120 ±10 °C Fan motor restart
Compressor protection	Temperature thermistor (Discharge temp.)	Activate	110 °C Compressor stop
		Reset	After 7 minutes Compressor restart
	Temperature thermistor (Compressor bottom temp.)	Activate	108 °C Compressor stop
		Reset	After 3 minutes, and 80 °C or less Compressor restart
	Thermal protection program (Outdoor temp.) (Only in COOL or DRY mode)	Activate	-20 °C Compressor stop
		Reset	-15 °C Compressor restart

13. Function settings

13-1. Setting methods

⚠ WARNING

Never touch electrical components such as the terminal blocks or reactor except the switch on the display board. It may cause a serious accident such as electric shock.

⚠ CAUTION

- Once refrigerant charging is completed, be sure to open the valve prior to performing the local settings. Otherwise, the compressor may fail.
- Discharge any static electricity from your body before touching the push switches. Never touch any terminal or pattern of any parts on the control board.

The positions of the switches on the outdoor unit control board are shown in the figure below.

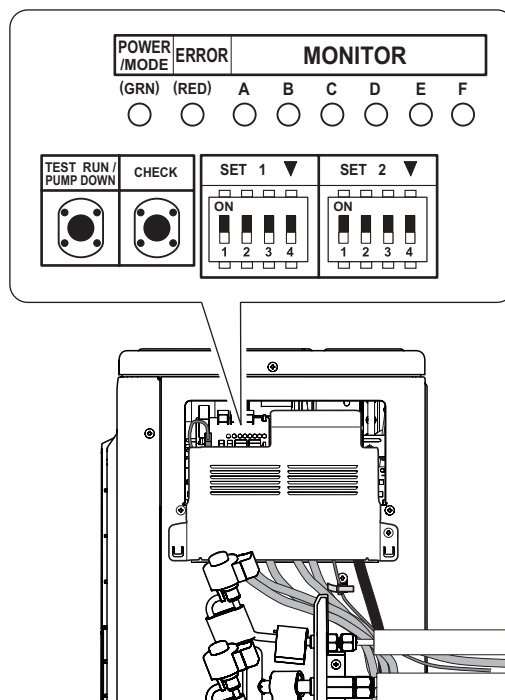

■ Setting method

Various settings can be adjusted by changing DIP switches and push switches on the PCB of the outdoor unit.

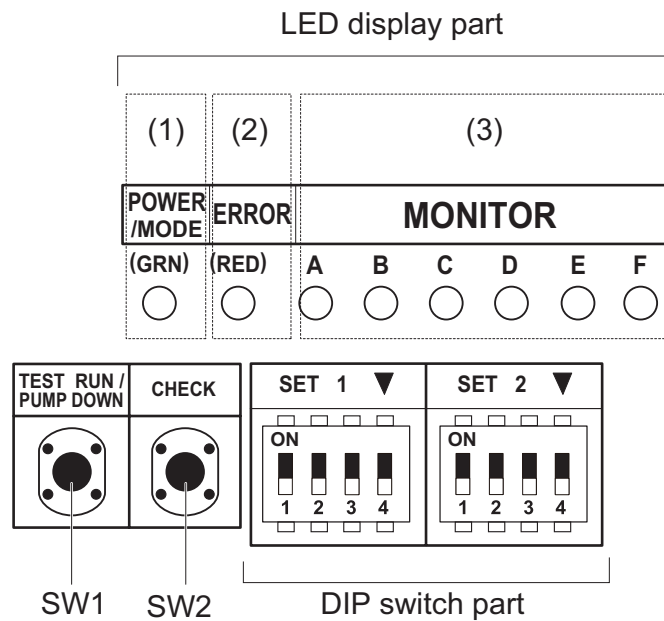

1. Be sure to disconnect the power supply or turn off the breaker.
2. Change the DIP switch setting according to the required setting.

■ Description of display

LED lamp			Function or operation method
(1)	POWER/MODE	Green	<ul style="list-style-type: none"> Turns on when the power supply is ON (Including when error occurs). Indicate the MODE by the number of flashes when the installation function is active.
(2)	ERROR	Red	Flashes at high-speed when there is an error.
(3)	MONITOR	A	<ul style="list-style-type: none"> Displays the location and contents of errors when there is an error. (Refer to Chapter 14-3. "Error code" on page 370 for details.) Displays when check run is activated. (Refer to Chapter 14-1. "Check run" on page 363 for details.)
		B	
		C	
		D	
		E	
		F	

Switch		Function or operation method	Factory setting
SW1	Push	<ul style="list-style-type: none"> For the test run start and stop. For the pump down start and stop. 	—
SW2	Push	<ul style="list-style-type: none"> For when check run function is activated. For displaying the check run. For resetting the Automatic wiring correction memory. 	—
SET1-1	DIP	For selecting cooling or heating during test operation.	OFF
SET1-2	DIP	For switching SW1 operation.	OFF
SET1-3	DIP	(Prohibited)	OFF (Do not change)
SET1-4	DIP	For outdoor unit low noise operation function.	OFF
SET2-1	DIP	For selecting outdoor unit low noise operation function.	OFF
SET2-2	DIP	(Prohibited)	OFF (Do not change)
SET2-3	DIP	Changing the current limit	OFF
SET2-4	DIP		

Be sure to disconnect the power supply or turn off the breaker before changing the DIP switch setting.

13-2. Outdoor unit low noise operation function (option)

Change the outdoor unit low noise operation by using this setting.

⚠ CAUTION

- When the low noise operation function is working, cooling and heating capacity will decrease.
- When changing the settings, explain to the customer beforehand that the capacity decreases.

NOTES:

- When SET1-4 is OFF, optional Central remote controller is required to use this function.
- When SET1-4 is ON, "Operation" and "Non-operation" mode of this function cannot be switched from the Central remote controller.

SET1-4	Setting	Factory setting
ON	Continuous operation	
OFF	Follow the Central remote controller settings	◆

SET2-1	Setting	Factory setting
ON	Lower	
OFF	Low	◆

13-3. Changing the current limit function

Change the outdoor unit current limit function by using this setting.

⚠ CAUTION

- When the current limited function is working, cooling and heating capacity will decrease.
- When changing the settings, explain to the customer beforehand that the capacity decreases.

SET2-3	SET2-4	Current	Factory setting
OFF	OFF	Full	◆
ON	OFF	16.0 A	
OFF	ON	12.0 A	

14. Check and test

14-1. Check run

- The check run is a function to screen and detect any wiring errors.
- After carrying out the check run, you can use the automatic wiring correction function to correct the wiring.
- Normal operation is possible without using the check run. In this case, use the test run or forced cooling function of the indoor unit to confirm any wiring errors.

■ Things to confirm before starting the check run

To ensure safety, check that the following work, inspections and operations have been completed.

	Check item	Check column
1	Check that all work on the piping connecting the outdoor unit, indoor units has been completed.	
2	Check that all work on the wiring connecting the outdoor unit, indoor units has been completed.	
3	Is there a gas leakage? (At pipe connections [flange connections and brazed areas])	
4	Is the system charged with the specified volume of refrigerant?	
5	Is a breaker installed at the power supply cable of outdoor unit?	
6	Are the wires connected to the terminals without looseness, and in accordance with the specifications?	
7	Is the 3-way valve of the outdoor unit open? (Gas pipe and liquid pipe)	
8	Is the power supply connected for more than 12 hours?	

■ Restrictions applicable when performing the check run

- When the check run starts, all indoor units connected to the outdoor unit will start to run automatically. During the check run, you cannot check the operation of the indoor units separately. After the check run, check the operation of the indoor units separately in normal operation.
- The check run can be used when the temperature is within the operable temperature of the air conditioner.
- In the check run, the air conditioner will automatically switch between cooling and heating depending on the external temperature and internal temperature.
- The check run can be completed in about 30 minutes (cooling) or about 1 hour (heating), but may take more depending on the external and internal temperature conditions etc.
- Do not conduct the check run with all the windows in the room closed. Otherwise the room temperature could get too low or too high.
- Depending on the difference of the room temperature of each room, a judgment may be impossible.
- Check run is a special operation so there may be a noise louder than the normal refrigerant noise or a creaking noise.

4. After the check run is completed, results will be displayed. Fill the displayed results in the result table accordingly.

- **If the connection is correct (Example: When 4 indoor units are connected)**

After the number of connected units are displayed, the LED for each unit will light up in order from A to D.

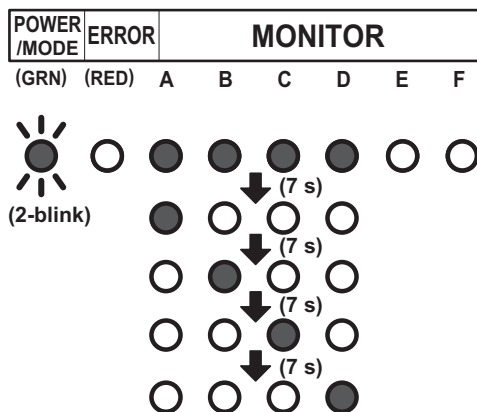

- **If the connection is incorrect (Example: When connection of B and C of the 4 units are reversed)**

After the number of connected units are displayed, B and C will light up in reverse.

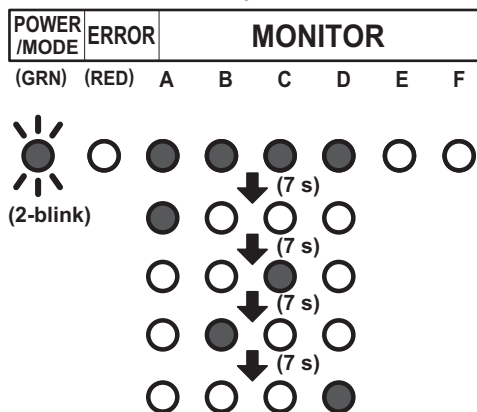

NOTES:

- Automatic wiring correction will not be completed if the power supply is disconnected while displaying the results. To confirm the automatic wiring correction, be sure to carry out step 5.
- If frost is formed on the outdoor unit while displaying the results, automatic defrost function will be operated. Proceed to step 5 after the defrost function is finished.

[How to record the contents]

- Fill the displayed results according to the following example.

Example: When piping A to D is connected but the wires for B and C are connected in reverse.

<Displayed results>

The LEDs will light up in 7 second intervals in the following order.

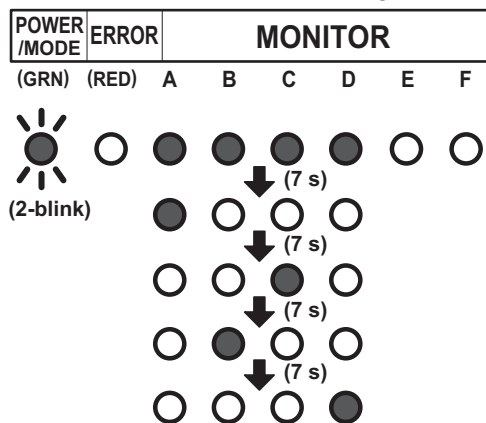

<Example of result table>

- Write a ● where the LEDs light up in the order that they light up.

	A	B	C	D	E	F
1	●	●	●	●	○	○
2	●	○	○	○	○	○
3	○	○	●	○	○	○
4	○	●	○	○	○	○
5	○	○	○	●	○	○
6	○	○	○	○	○	○
7	○	○	○	○	○	○

- Based on the results of step (a), record as follows.

- Trace the dotted circle with a pen if multiple places light up.

A	B	C	D	E	F
○	○	○	○	⋯	⋯

- Write the order from A to D in which the LEDs lit up inside the circle.

A	B	C	D	E	F
Ⓐ	Ⓒ	Ⓑ	Ⓓ	⋯	⋯

c. Select the correction method.

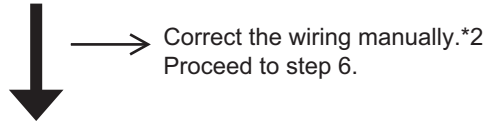

Use the Automatic wiring correction function.*1
Proceed to step 5.

Write down the same results in the label on the reverse side of the service panel.
The results recorded are needed at the time of servicing.

<Result Table>

	A	B	C	D	E	F
1	○	○	○	○	○	○
2	○	○	○	○	○	○
3	○	○	○	○	○	○
4	○	○	○	○	○	○
5	○	○	○	○	○	○
6	○	○	○	○	○	○
7	○	○	○	○	○	○

A	B	C	D	E	F
○	○	○	○	○	○

NOTES:

- *1: By using this function, the wiring is automatically corrected according to the piping.
- *2: When correcting the wiring manually, please disconnect the power supply or turn off the breaker during results display, and then change the wiring manually according to the obtained test results.

For example, in Example 1, the wirings connected to the terminals B and C is to be exchanged manually.

5. During results display, press the CHECK switch for 3 seconds or more.
After LEDs A to F have lit in turn, all LEDs will light up indicating that the automatic wiring correction is completed.

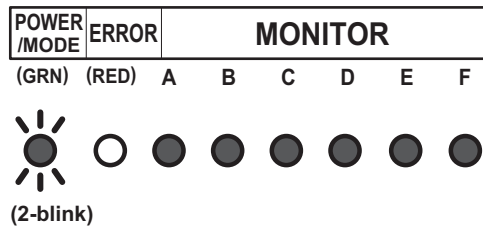

6. Disconnect the power supply or turn off the breaker and wait 10 minutes then turn the power back on and perform test run.

NOTE: If you do not disconnect the power supply or turn off the breaker, normal operation is not possible.

Notices:

- If an error occurs during check run it will be suspended. Correct the error and start check run again.
- After the check run, if automatic wiring correction is carried out, the indoor unit's position will be modified to match the piping. (Note that the display of the optional remote controller changes.)
- If you start check run again after the automatic wiring correction is finished, the modification will be reset.

■ Failure indication of check-run judgment

The check run stops when there is an error, and the LED shows the relevant error indication. When you encounter the errors described here, perform checking by using the cooling test run of the indoor unit.

• Temperature out of range judgment

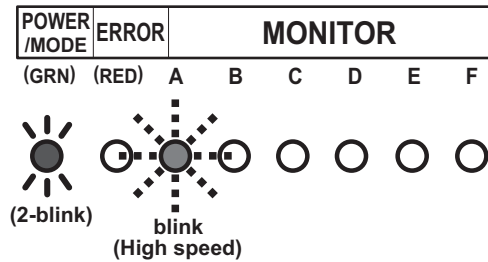

• Wiring/piping number difference

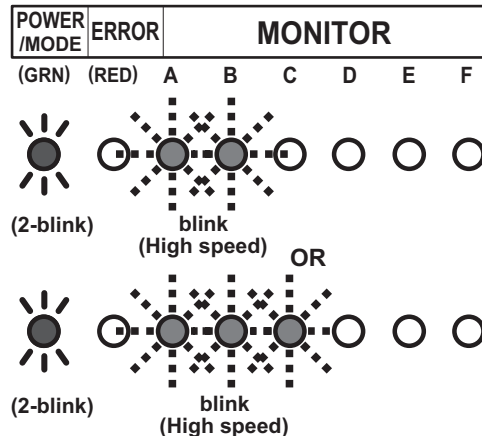

■ Redisplaying the results of check run

- When checking the content of automatic wiring correction, push the CHECK switch. The results of the check run is displayed. You can compare the result that is recorded in step (4) of "Chapter 14-1-3. ["Operating procedure for check run"](#) on page 364".
- If the automatic wiring correction is not completed, the POWER/MODE LED blinks twice and the MONITOR LED turns off.

■ Memory resetting of automatic wiring correction

⚠ CAUTION

When relocating the unit, reset the memory beforehand, or the unit may not function normally.

- Push the CHECK switch.
The LED lights as shown in ["Redisplaying the results of check run"](#) on page 368".
- When the LED is on, press the CHECK switch for more than 3 seconds.
- The LEDs from A to F light in sequence, and then all LEDs light to indicate the completion of the memory resetting of automatic wiring correction.
- Disconnect the power supply or turn off the breaker.

14-2. Test run

⚠ CAUTION

Always connect the power supply 12 hours prior to the start of the operation in order to protect the compressor.

1. Indoor unit
 - a. Is the drain normal?
 - b. Is there any abnormal noise and vibration during operation?
 2. Outdoor unit
 - a. Is there any abnormal noise and vibration during operation?
 - b. Will noise, wind, or drain water from the unit disturb the neighbors?
 - c. Is there any gas leakage?
- Do not operate the air conditioner in the test running state for a long time.
 - For the operation method of the test run for indoor unit and central remote controller, refer to the operating manual and perform operation check.

■ Test run method

Be sure to temporarily disconnect the power supply or turn off the breaker before changing the DIP switch settings.

1. Check the 3-way valves (both at the liquid side and gas side) are opened. Confirm that the DIP switch SET1-2 is switched off.
2. Set the operation mode to COOL or HEAT. When switching the DIP switch SET1-1 between HEAT and COOL, disconnect the power supply or turn off the circuit breaker beforehand.

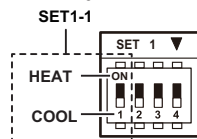

- In the first test run, be sure to set the operation mode to COOL.
- The operation mode cannot be switched between COOL and HEAT during the test run. To switch the operation mode between COOL and HEAT, stop the test run, switch the operation mode, and then start the test run again.
3. Push TEST RUN switch for more than 3 seconds. The POWER / MODE LED flashes once.

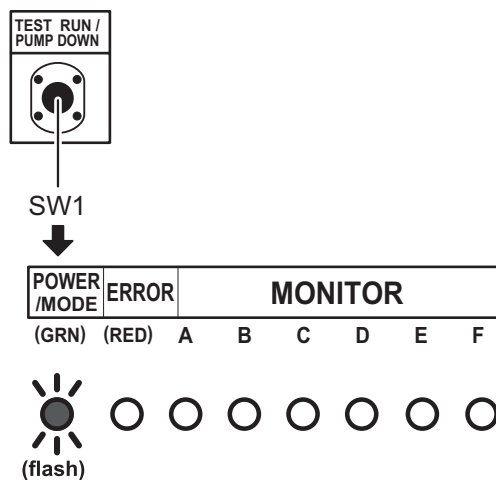

4. Confirm operating status.

5. Push TEST RUN switch for more than 3 seconds.

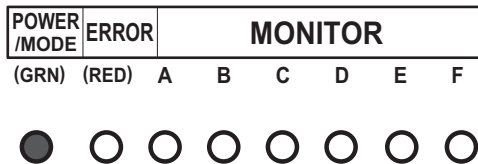

POWER/MODE LED will turn on, and test run stops.

14-3. Error code

If an error occurs, the LED lights to inform the relevant location and the code. When error occurs, the error LED blinks at high speed.

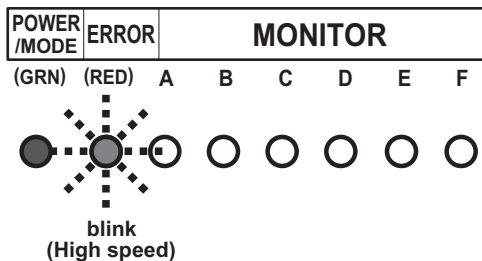

■ Error location

LEDs A to F of MONITOR light and indicate the location of the error. In the case of an overall error, LEDs A to F of MONITOR do not light.

Example: Coil error on indoor unit B

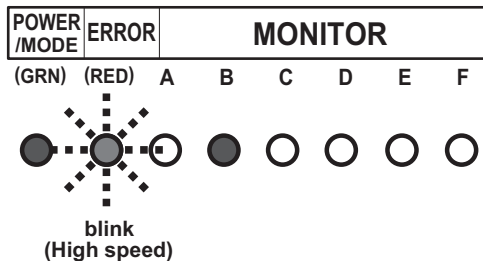

■ Error code display

While the error is occurring, briefly push the SW1. The error code is displayed.

Example: Coil error (Error cord = 9A.1)

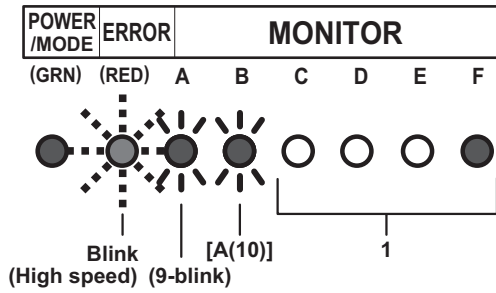

Display mode

LED on: ●

LED off: ○

Blink: 
(0.5s Light on / 0.5s Light off)

Number of blinking: ()

For MONITOR (A and B)

- A: 10-blink
- C: 11-blink
- F: 12-blink
- J: 13-blink
- P: 14-blink
- U: 15-blink

C	D	E	F	
○	○	○	●	→ 1
○	○	●	○	→ 2
○	○	●	●	→ 3
○	●	○	○	→ 4
○	●	○	●	→ 5
○	●	●	○	→ 6
○	●	●	●	→ 7
●	○	○	○	→ 8
●	○	○	●	→ 9
●	○	●	○	→ A
●	○	●	●	→ C
●	●	○	○	→ F
●	●	○	●	→ J
●	●	●	○	→ P
●	●	●	●	→ U

Error code	Error type
11.3	Serial communication error
11.4	Serial communication error during operation
16.5	Communication error between controller and outdoor unit
22.1	Indoor unit capacity error
23.1	Connection prohibited (Series error)
5U.1	Indoor unit error
62.1	PCB model information error
62.3	EEPROM access error
62.8	EEPROM data corruption error
63.1	Inverter error
65.3	IPM error (Trip terminal L error)
71.1	Discharge temp. sensor error
72.1	Compressor temp. sensor error
73.2	Heat exchanger middle temp. sensor error
73.3	Heat exchanger liquid temp. sensor error
74.1	Outdoor temp. sensor error
75.1	Suction gas temp. sensor error
76.1	Valve sensor error
76.2	
77.1	Heat sink temp. sensor error
84.1	Current sensor 1 error (stoppage permanently)
86.1	Discharge pressure sensor error
86.4	High pressure switch 1 error
94.1	Trip detection
95.1	Compressor motor control error (stoppage permanently)
97.3	Fan motor 1 error (Duty error)
98.3	Fan motor 2 error (Duty error)
99.1	4-way valve error
9A.1	Coil 1 (expansion valve 1) error
A1.1	Discharge temperature 1 error (stoppage permanently)
A3.1	Compressor 1 temperature error

14-4. Pump down

⚠ WARNING

During the pump down operation, make sure that compressor is off before you remove the refrigerant piping. Do not remove the connection pipe while the compressor is in operation with valve open. This may cause abnormal pressure in the refrigeration cycle that leads to breakage and even injury.

■ Pump down operation

When moving or discarding the air conditioner, in order to consider the environment and avoid the discharge of refrigerant to the atmosphere, pump down according to the following procedure.

1. Connect the pressure gauge to the charging port.
2. Change the DIP switch on the board (SET1-2) to ON.
*Be sure the power supply is disconnected on the breaker is turned off when changing the DIP switch.

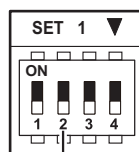

DIP switch
(SET1-2)

3. To start operation, push the PUMP DOWN switch (SW1) for 3 seconds or push the switch after the power has been on for 3 minutes.



Push switch (SW1)

During pump down, the LED (POWER/MODE) blinks 3 times consecutively.

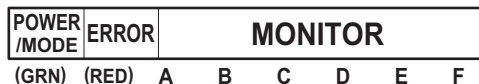

(3-blink)

NOTE: If the PUMP DOWN switch (SW1) is pushed while the compressor is in operation, the compressor stops and the operation restart after about 3 minutes.

4. Close the liquid pipe valve.
5. When the value between 7.3 psi and 0 psi (0.05 Mpa to 0 Mpa) is shown, close the gas pipe valve.
6. Stop the pump down operation by pushing the PUMP DOWN switch (SW1) for 3 seconds. The LED light as follows.



(3-blink)

7. Disconnect the power supply or turn off the breaker.

- NOTE:**
- Even if the pump down operation is not stopped by pushing the switch as in step 6, the operation stops automatically after 15 minutes, and the LED light as follows.

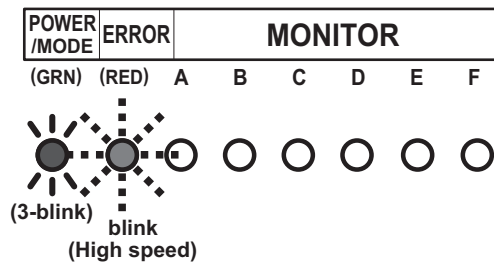

- After completing the pump down operation, disconnect the power supply or turn off the breaker.
 - If the pump down operation still continues, open the liquid pipe valve. Then perform the procedure again starting from step 3.
- To cancel the pump down operation, push the PUMP DOWN switch (SW1) again. The indication of the LED returns to the original state which is before starting the pump down operation.
(POWER/MODE LED: On)
- The pump down may stop before completion due to an error. To complete the pump down operation, correct the error, open the liquid pipe valve and then start from step 1 again. Otherwise, the refrigerant can be recovered from the service port.

15. Accessories

15-1. Model: AOYG30KBTA4

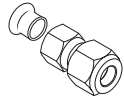
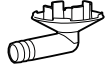
Part name	Exterior	Q'ty	Part name	Exterior	Q'ty
Installation manual		1	Adapter K: mm (in) 12.70 (1/2) to 9.52 (3/8)		2
Drain pipe		1			

16. Outdoor unit installation precautions

NOTE: The information listed below are general precautions.
Some models also include items that do not apply.

16-1. Places where prohibited for use

- Places where there is a danger of combustible gas leakage.
- Places where sulfur gas, chlorine gas, acid, alkali, or other matter which effects equipment is generated.
- Places affected by heat radiation from other heat sources.
- Places where the air is stagnant.
- Places where machinery which generates high frequencies is used.
- Ocean beaches and other areas where there is a lot of salt.
- Inside of vehicles, ships, and other conveyances.
- Places where voltage fluctuations are large such as a factory.

16-2. Points to remember when installing

- The product shall be installed at a place which can withstand the weight and vibration of the outdoor unit.
- To allow maintenance after refrigerant piping, drain piping, and electric wiring connection and installation, provide an installation service space.
*Installation service space is shown in "[Installation space](#)" on page 307.
- Be careful when installing the set at the following places.

Condition	Contents	Countermeasures (Reference)
When installed near adjacent houses.	Perform installation work so that operating sound does not disturb the neighbors.	<ol style="list-style-type: none"> 1. Install a soundproof barrier. 2. Change the installation site.
When there is the possibility of strong wind.	<ul style="list-style-type: none"> • If the outdoor unit is exposed to strong wind, capacity may drop, frost may form during heating, and operation may be stopped by high pressure rise. In addition, when a very strong wind blows, the fan may be damaged. • When a very strong wind blows, there is the possibility of the outdoor unit being toppled over if held only by foundation bolts. 	<ol style="list-style-type: none"> 1. Install the outdoor unit with keeping a sufficient distance between the outlet side of the unit and a facing wall or fence. 2. Make the outlet direction and wind direction perpendicular. 3. Fasten the outdoor unit using toppling prevention hardware (purchased locally).
When snow accumulates.	If the outdoor unit is covered by accumulated snow, it may not be able to operate.	<ol style="list-style-type: none"> 1. Make the foundation as high as possible. 2. Perform snow prevention work.
When installing the inverter type.	It may generate noise in TV sets, stereos and PCs.	The inverter type should be installed at a sufficient distance from these equipments.

Part 3. OUTDOOR UNIT (5 UNITS TYPE)

**MULTI-SPLIT TYPE:
AOYG36KBTA5**

1. Specifications

Type			Inverter heat pump		
Model name			AOYG36KBTAs		
Power source			230 V 50 Hz		
Available voltage range			198—264V		
Standard combination of indoor unit			Wall mounted ASYG07KMCC ×5		
Capacity	Cooling	Rated	kW	9.5	
			Btu/h	32,400	
		Min.—Max.	kW	3.0—11.0	
				Btu/h	10,200—37,500
	Heating	Rated	kW	10.6	
			Btu/h	36,200	
Min.—Max.		kW	3.5—12.0		
			Btu/h	11,900—40,900	
Input power	Cooling	Rated	kW	2.50	
		Max.		3.45	
	Heating	Rated		2.36	
		Max.		3.25	
Current	Cooling	Rated	A	11.1	
	Heating	Rated		10.9	
EER	Cooling		kW/kW	3.8	
COP	Heating			4.5	
Starting current			A	11.1	
Maximum operating current *1			A	20.0	
Fan	Type × Qty		Propeller × 1		
	Airflow rate	Cooling	m ³ /h	2,450	
		Heating		2,900	
	Motor output		W	49	
Sound pressure level *2	Cooling		dB (A)	52	
	Heating			55	
Heat exchanger	Dimension (H × W × D)		mm	Main1: 840 × 873 × 18.19 Main2: 840 × 843 × 18.19 Main3: 840 × 784 × 18.19	
	Fin pitch			1.45	
	Rows × Stages			Main1: 1 × 40 Main2: 1 × 40 Main3: 1 × 40	
	Pipe type (Material)		Copper tube		
	Fin type (Material)		Aluminum		
	Type × Quantity		DC twin rotary × 1		
Compressor	Motor output		W	1,450	
	Type	R32 (675)			
Refrigerant	Charge		g	2,500	
	Type	RmM68AF			
Refrigerant oil	Amount		cm ³	800	
	Material		Steel sheet		
Enclosure	Color		Beige (Approximate color of Munsell 10YR 7.5/1.0 NN)		
	Dimensions (H × W × D)	Net	mm	884 × 820 × 315	
Gross		1,058 × 1,027 × 445			
Weight	Net	kg	59		
	Gross		69		
Connection pipe	Size	Liquid	mm (in)	Ø6.35 (Ø1/4) × 5	
		Gas		Ø9.52 (Ø3/8) × 3 + Ø12.7 (Ø1/2) × 2	
	Method		Flare		
	Pre-charge length (Total)		40		
	Maximum length (Total)		75		
	Maximum length (Each)		25		
	Minimum length (Total)		15		
	Minimum length (Each)		2.5		
	Maximum height difference between outdoor unit and each indoor units.		15		
	Maximum height difference between indoor units.		10		
Drain hose	Material		PP		
	Tip diameter		mm	Ø13.0 (I.D.), Ø16.0 to Ø16.8 (O.D.)	
Operation range	Cooling		°C	-10 to 46	
	Heating			-15 to 24	

NOTES:

- Specifications are based on the following conditions:
 - Power source of specifications: 230 V
 - Pipe length: 5 m, Height difference: 0 m [Outdoor unit—Indoor unit]
 - Cooling: Indoor temperature of 27.0 °CDB/19.0 °CWB, and outdoor temperature of 35 °CDB/24.0 °CWB.
 - Heating: Indoor temperature of 20.0 °CDB/15.0 °CWB, and outdoor temperature of 7.0 °CDB/6.0 °CWB.
- *1: Maximum operating current is the total current of the indoor unit and the outdoor unit.
- *2: Sound pressure level
 - Measured values in manufacturer's anechoic chamber.
 - Because of the surrounding sound environment, the sound levels measured in actual installation conditions might be higher than the specified values here.
- For other combination, refer to the combination table.
- The protective function might work when using it outside the operation range.
- This data is based on EN 14511 standard.

Specifications for ErP Lot10				
Model name		AOYG36KBT A5		
Energy efficiency class	Cooling	A+++		
	Heating (Average)	A++		
Pdesign	Cooling	kW	9.5 (35 °C)	
	Heating (Average)		7.0 (-10 °C)	
SEER	Cooling	kWh/kWh	8.50	
SCOP	Heating (Average)		4.60	
Annual energy consumption	QCE	kWh/a	391	
	QHE (Average)		2,130	
Sound power level	Cooling	HIGH	dB (A)	65
	Heating			68

2. Dimensions

2-1. Model: AOYG36KBTA5

Unit: mm

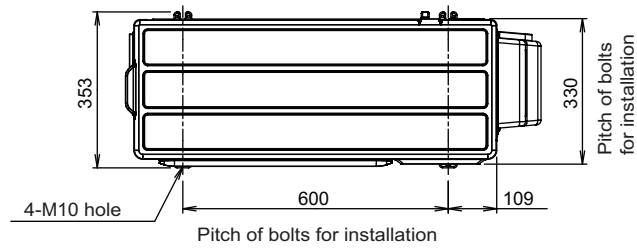

Top view

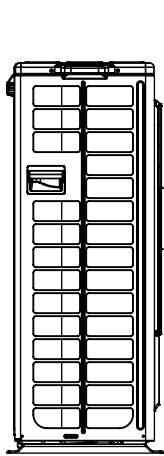

Side view

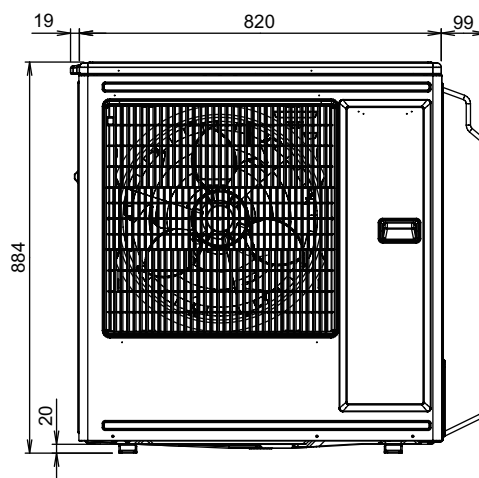

Front view

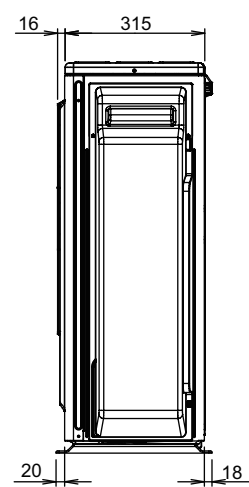

Side view

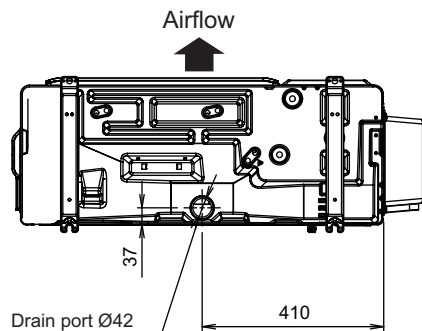

Bottom view

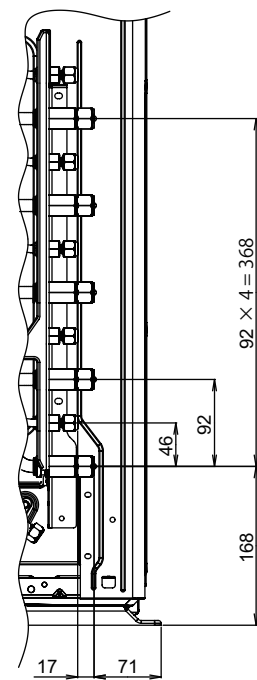

Side view (Valve part)

OUTDOOR UNIT
AOYG36KBTA5

OUTDOOR UNIT
AOYG36KBTA5

3. Installation space

3-1. Model: AOYG36KBTA5

■ Space requirement

Provide sufficient installation space for product safety.

⚠ CAUTION

Keep the space shown in the installation examples.

If the installation is not performed accordingly, it could cause a short circuit and result in a lack of operating performance.

● Single outdoor unit installation

- When the upper space is open:

Unit: mm

Obstacles at rear only

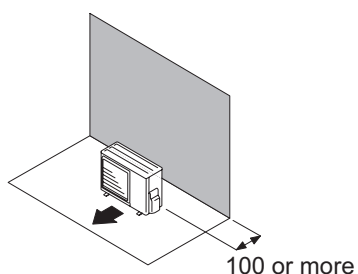

Obstacles at rear and sides

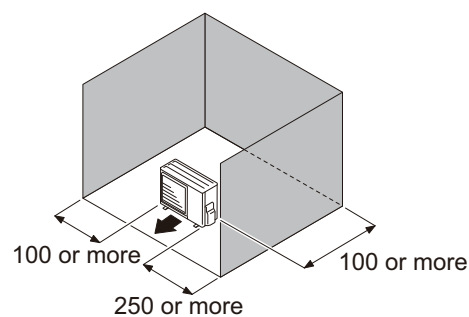

Obstacles at front

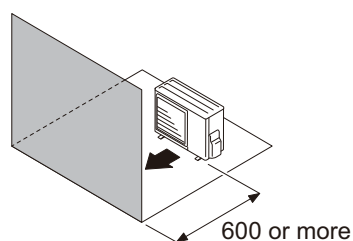

Obstacles at front and rear

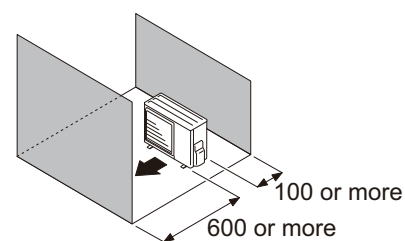

- When an obstruction in the upper space:

Unit: mm

Obstacles at rear and above

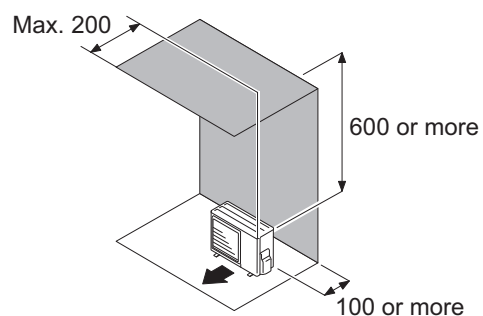

Obstacles at rear, sides, and above

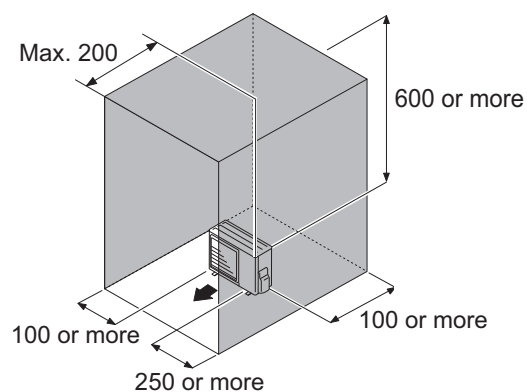

● Multiple outdoor unit installation

- Provide at least 250 mm of space between the outdoor units if multiple units are installed.
- When routing the piping from the side of an outdoor unit, provide space for piping.
- No more than 3 units must be installed side by side.
When 4 units or more are arranged in a line, provide the space as shown in the following example **“When an obstruction in the upper space:”**.
- **When the upper space is open:**

Unit: mm

Obstacles at rear only

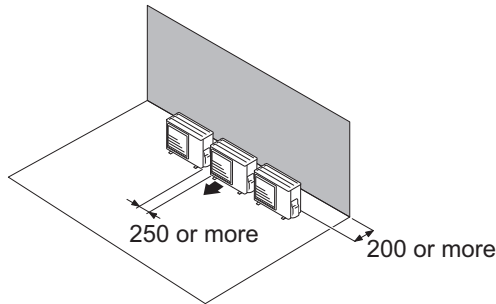

Obstacles at front only

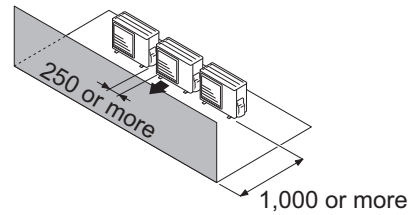

Obstacles at front and rear

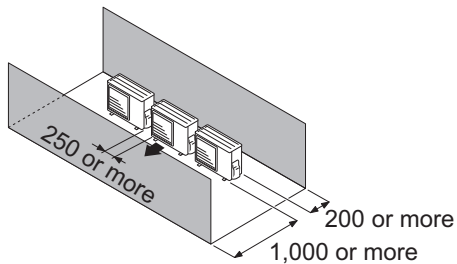

- **When an obstruction in the upper space:**

Unit: mm

Obstacles at rear and above.

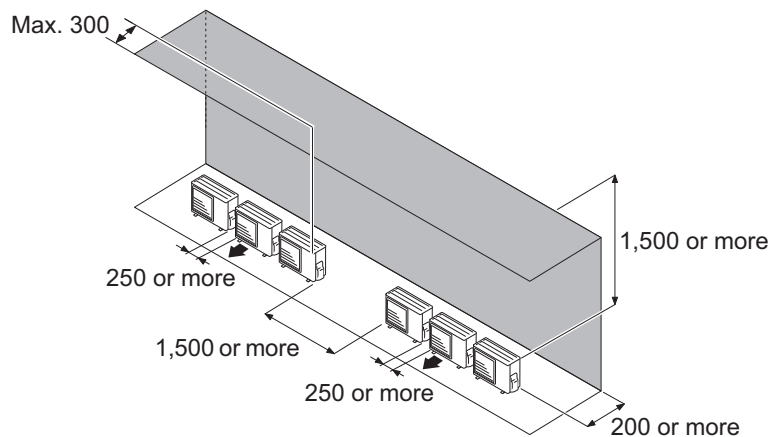

OUTDOOR UNIT
AOYG36KBT A5

OUTDOOR UNIT
AOYG36KBT A5

● Outdoor units installation in multi-row

Unit: mm

Single parallel unit arrangement

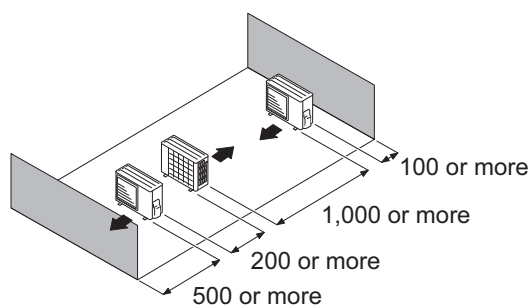

Multiple parallel unit arrangement

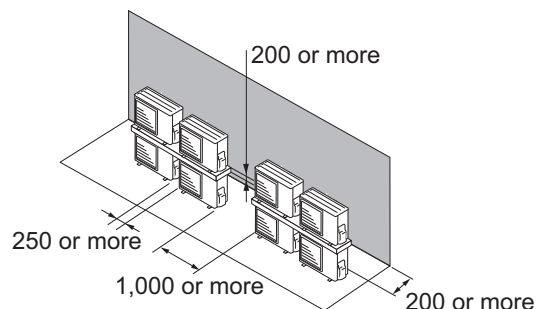
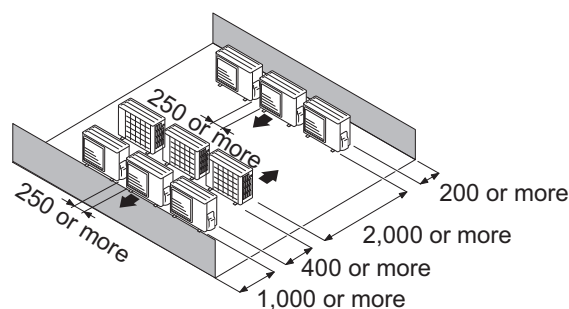

NOTES:

- If the space is larger than stated above, the condition will be the same as when there is no obstacle.
- When installing the outdoor unit, be sure to open the front and left side to obtain better operation efficiency.

⚠ CAUTION

- Do not install the outdoor unit in two-stage where the drain water could freeze. Otherwise the drainage from the upper unit may form ice and cause a malfunction of the lower unit.
- When the outdoor temperature is 0 °C or less, do not use the accessory drain pipe and drain cap. If the drain pipe and drain cap are used, the drain water in the pipe may freeze in extremely cold climate. (For reverse cycle model only.)
- In area with heavy snowfall, if the inlet and outlet of the outdoor unit is blocked with snow, it might become difficult to get warm, and it is likely to cause product malfunction. Construct a canopy and a pedestal, or place the unit on a high stand that is locally installed.

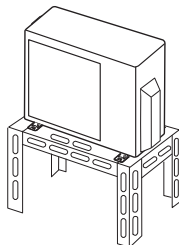

4. Refrigerant circuit

4-1. Model: AOYG36KBT A5

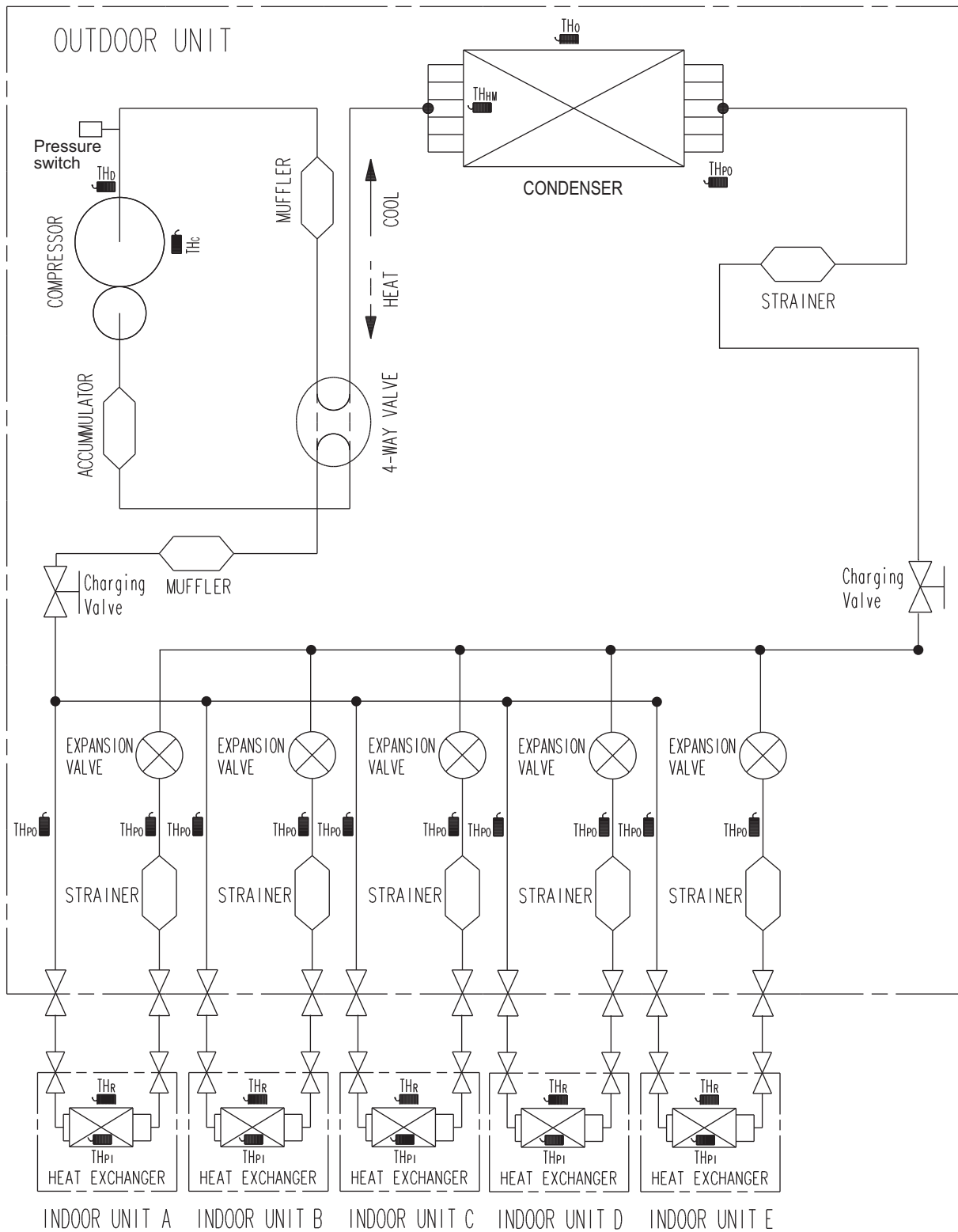

OUTDOOR UNIT
AOYG36KBT A5

OUTDOOR UNIT
AOYG36KBT A5

TH_o : THERMISTOR(DISCHARGE TEMP.)
 TH_o : THERMISTOR(OUTDOOR TEMP.)
 TH_{po} : THERMISTOR(PIPE TEMP.)
 TH_c : THERMISTOR(COMPRESSOR TEMP.)

TH_r : THERMISTOR(ROOM TEMP.)
 TH_{p1} : THERMISTOR(PIPE TEMP.)
 TH_{M} : THERMISTOR(HEAT EXCHANGER MIDDLE TEMP.)

5. Wiring diagram

5-1. Model: AOYG36KBTA5

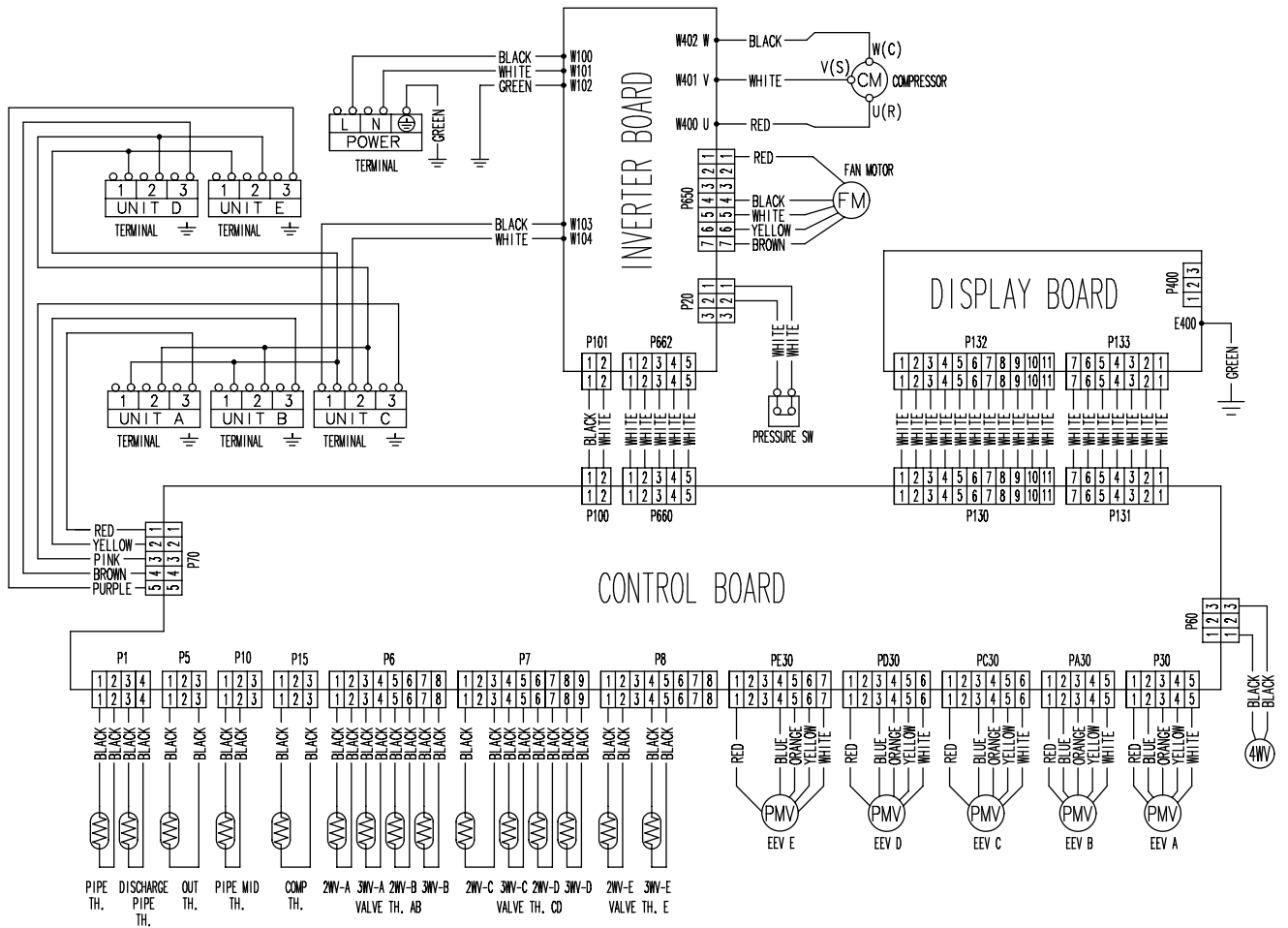

OUTDOOR UNIT
AOYG36KBTA5

OUTDOOR UNIT
AOYG36KBTA5

6. Capacity table

6-1. Combinations

■ Model: AOYG36KBTA5

● Cooling

Combination of indoor unit						Rated capacity for each indoor unit (kW)					Total capacity (kW)			Input power (kW)			EER (W/W)	Seasonal data		
Room					Total	Room					Min.	Rated	Max.	Min.	Rated	Max.		Pdesign (kW)	SEER (kWh/kWh)	Energy efficiency class
1	2	3	4	5		1	2	3	4	5										
7	24	—	—	—	31	2.00	7.00	—	—	—	3.0	9.00	11.0	0.30	2.91	3.45	3.09	9.0	7.9	A++
9	22	—	—	—	31	2.50	6.00	—	—	—	3.0	8.50	11.0	0.30	2.67	3.45	3.18	8.5	7.9	A++
9	24	—	—	—	33	2.50	7.00	—	—	—	3.0	9.50	11.0	0.30	3.17	3.45	3.00	9.5	7.8	A++
12	22	—	—	—	34	3.50	6.00	—	—	—	3.0	9.50	11.0	0.30	3.17	3.45	3.00	9.5	7.8	A++
12	24	—	—	—	36	3.17	6.33	—	—	—	3.0	9.50	11.0	0.30	3.17	3.45	3.00	9.5	7.8	A++
14	22	—	—	—	36	3.69	5.81	—	—	—	3.0	9.50	11.0	0.30	3.17	3.45	3.00	9.5	7.8	A++
14	24	—	—	—	38	3.50	6.00	—	—	—	3.0	9.50	11.0	0.30	3.17	3.45	3.00	9.5	7.8	A++
18	18	—	—	—	36	4.75	4.75	—	—	—	3.0	9.50	11.0	0.30	3.17	3.45	3.00	9.5	7.8	A++
18	22	—	—	—	40	4.27	5.23	—	—	—	3.0	9.50	11.0	0.30	3.17	3.45	3.00	9.5	7.8	A++
18	24	—	—	—	42	4.07	5.43	—	—	—	3.0	9.50	11.0	0.30	3.17	3.45	3.00	9.5	7.8	A++
22	22	—	—	—	44	4.75	4.75	—	—	—	3.0	9.50	11.0	0.30	3.17	3.45	3.00	9.5	7.8	A++
22	24	—	—	—	46	4.54	4.96	—	—	—	3.0	9.50	11.0	0.30	3.17	3.45	3.00	9.5	7.8	A++
24	24	—	—	—	48	4.75	4.75	—	—	—	3.0	9.50	11.0	0.30	3.17	3.45	3.00	9.5	7.8	A++
7	7	14	—	—	28	2.00	2.00	4.00	—	—	3.0	8.00	10.0	0.30	2.26	2.88	3.54	8.0	8.2	A++
7	7	18	—	—	32	2.00	2.00	5.00	—	—	3.0	9.00	11.0	0.30	2.68	3.45	3.36	9.0	8.1	A++
7	7	22	—	—	36	1.85	1.85	5.80	—	—	3.0	9.50	11.0	0.30	2.91	3.45	3.27	9.5	8.0	A++
7	7	24	—	—	38	1.75	1.75	6.00	—	—	3.0	9.50	11.0	0.30	2.91	3.45	3.27	9.5	8.0	A++
7	9	12	—	—	28	2.00	2.50	3.50	—	—	3.0	8.00	10.0	0.30	2.26	2.88	3.54	8.0	8.2	A++
7	9	14	—	—	30	2.00	2.50	4.00	—	—	3.0	8.50	10.7	0.30	2.46	3.27	3.45	8.5	8.1	A++
7	9	18	—	—	34	2.00	2.50	5.00	—	—	3.0	9.50	11.0	0.30	2.91	3.45	3.27	9.5	8.0	A++
7	9	22	—	—	38	1.75	2.25	5.50	—	—	3.0	9.50	11.0	0.30	2.91	3.45	3.27	9.5	8.0	A++
7	9	24	—	—	40	1.66	2.14	5.70	—	—	3.0	9.50	11.0	0.30	2.91	3.45	3.27	9.5	8.0	A++
7	12	12	—	—	31	2.00	3.50	3.50	—	—	3.0	9.00	11.0	0.30	2.68	3.45	3.36	9.0	8.1	A++
7	12	14	—	—	33	2.00	3.50	4.00	—	—	3.0	9.50	11.0	0.30	2.91	3.45	3.27	9.5	8.0	A++
7	12	18	—	—	37	1.80	3.08	4.62	—	—	3.0	9.50	11.0	0.30	2.91	3.45	3.27	9.5	8.0	A++
7	12	22	—	—	41	1.62	2.78	5.10	—	—	3.0	9.50	11.0	0.30	2.91	3.45	3.27	9.5	8.0	A++
7	12	24	—	—	43	1.55	2.65	5.30	—	—	3.0	9.50	11.0	0.30	2.91	3.45	3.27	9.5	8.0	A++
7	14	14	—	—	35	1.90	3.80	3.80	—	—	3.0	9.50	11.0	0.30	2.91	3.45	3.27	9.5	8.0	A++
7	14	18	—	—	39	1.71	3.41	4.38	—	—	3.0	9.50	11.0	0.30	2.91	3.45	3.27	9.5	8.0	A++
7	14	22	—	—	43	1.55	3.09	4.86	—	—	3.0	9.50	11.0	0.30	2.91	3.45	3.27	9.5	8.0	A++
7	14	24	—	—	45	1.47	2.96	5.07	—	—	3.0	9.50	11.0	0.30	2.91	3.45	3.27	9.5	8.0	A++
7	18	18	—	—	43	1.54	3.98	3.98	—	—	3.0	9.50	11.0	0.30	2.91	3.45	3.27	9.5	8.0	A++
7	18	22	—	—	47	1.41	3.64	4.45	—	—	3.0	9.50	11.0	0.30	2.91	3.45	3.27	9.5	8.0	A++
7	18	24	—	—	49	1.36	3.49	4.65	—	—	3.0	9.50	11.0	0.30	2.91	3.45	3.27	9.5	8.0	A++
9	9	9	—	—	27	2.50	2.50	2.50	—	—	3.0	7.50	9.6	0.30	2.07	2.70	3.63	7.5	8.2	A++
9	9	12	—	—	30	2.50	2.50	3.50	—	—	3.0	8.50	10.7	0.30	2.46	3.27	3.45	8.5	8.1	A++
9	9	14	—	—	32	2.50	2.50	4.00	—	—	3.0	9.00	11.0	0.30	2.68	3.45	3.36	9.0	8.1	A++
9	9	18	—	—	36	2.38	2.38	4.74	—	—	3.0	9.50	11.0	0.30	2.91	3.45	3.27	9.5	8.0	A++
9	9	22	—	—	40	2.14	2.14	5.22	—	—	3.0	9.50	11.0	0.30	2.91	3.45	3.27	9.5	8.0	A++
9	9	24	—	—	42	2.04	2.04	5.42	—	—	3.0	9.50	11.0	0.30	2.91	3.45	3.27	9.5	8.0	A++
9	12	12	—	—	33	2.50	3.50	3.50	—	—	3.0	9.50	11.0	0.30	2.91	3.45	3.27	9.5	8.0	A++
9	12	14	—	—	35	2.44	3.26	3.80	—	—	3.0	9.50	11.0	0.30	2.91	3.45	3.27	9.5	8.0	A++
9	12	18	—	—	39	2.19	2.92	4.39	—	—	3.0	9.50	11.0	0.30	2.91	3.45	3.27	9.5	8.0	A++
9	12	22	—	—	43	1.99	2.65	4.86	—	—	3.0	9.50	11.0	0.30	2.91	3.45	3.27	9.5	8.0	A++
9	12	24	—	—	45	1.90	2.53	5.07	—	—	3.0	9.50	11.0	0.30	2.91	3.45	3.27	9.5	8.0	A++
9	14	14	—	—	37	2.32	3.59	3.59	—	—	3.0	9.50	11.0	0.30	2.91	3.45	3.27	9.5	8.0	A++
9	14	18	—	—	41	2.09	3.24	4.17	—	—	3.0	9.50	11.0	0.30	2.91	3.45	3.27	9.5	8.0	A++
9	14	22	—	—	45	1.90	2.96	4.64	—	—	3.0	9.50	11.0	0.30	2.91	3.45	3.27	9.5	8.0	A++
9	14	24	—	—	47	1.82	2.83	4.85	—	—	3.0	9.50	11.0	0.30	2.91	3.45	3.27	9.5	8.0	A++
9	18	18	—	—	45	1.90	3.80	3.80	—	—	3.0	9.50	11.0	0.30	2.91	3.45	3.27	9.5	8.0	A++
9	18	22	—	—	49	1.74	3.49	4.27	—	—	3.0	9.50	11.0	0.30	2.91	3.45	3.27	9.5	8.0	A++
9	18	24	—	—	51	1.68	3.35	4.47	—	—	3.0	9.50	11.0	0.30	2.91	3.45	3.27	9.5	8.0	A++
12	12	12	—	—	36	3.17	3.17	3.17	—	—	3.0	9.50	11.0	0.30	2.91	3.45	3.27	9.5	8.0	A++
12	12	14	—	—	38	3.00	3.00	3.50	—	—	3.0	9.50	11.0	0.30	2.91	3.45	3.27	9.5	8.0	A++
12	12	18	—	—	42	2.71	2.71	4.08	—	—	3.0	9.50	11.0	0.30	2.91	3.45	3.27	9.5	8.0	A++
12	12	22	—	—	46	2.48	2.48	4.54	—	—	3.0	9.50	11.0	0.30	2.91	3.45	3.27	9.5	8.0	A++
12	12	24	—	—	48	2.38	2.38	4.74	—	—	3.0	9.50	11.0	0.30	2.91	3.45	3.27	9.5	8.0	A++
12	14	14	—	—	40	2.84	3.33	3.33	—	—	3.0	9.50	11.0	0.30	2.91	3.45	3.27	9.5	8.0	A++
12	14	18	—	—	44	2.59	3.02	3.89	—	—	3.0	9.50	11.0	0.30	2.91	3.45	3.27	9.5	8.0	A++
12	14	22	—	—	48	2.38	2.77	4.35	—	—	3.0	9.50	11.0	0.30	2.91	3.45	3.27	9.5	8.0	A++
12	14	24	—	—	50	2.28	2.66	4.56	—	—	3.0	9.50	11.0	0.30	2.91	3.45	3.27	9.5	8.0	A++
12	18	18	—	—	48	2.38	3.56	3.56	—	—	3.0	9.50	11.0	0.30	2.91	3.45	3.27	9.5	8.0	A++
12	18	22	—	—	52	2.19	3.29	4.02	—	—	3.0	9.50	11.0	0.30	2.91	3.45	3.27	9.5	8.0	A++
12	18	24	—	—	54	2.11	3.17	4.22	—	—	3.0	9.50	11.0	0.30	2.91	3.45	3.27	9.5	8.0	A++
14	14	14	—	—	42	3.17	3.17	3.17	—	—	3.0	9.50	11.0	0.30	2.91	3.45	3.27	9.5	8.0	A++
14	14	18	—	—	46	2.89	2.89	3.72	—	—	3.0	9.50	11.0	0.30	2.91	3.45	3.27	9.5	8.0	A++
14	14	22	—	—	50	2.66	2.66	4.18	—	—	3.0	9.50	11.0	0.30	2.91	3.45	3.27	9.5	8.0	A++
14	14	24	—	—	52	2.56	2.56	4.38	—	—	3.0	9.50	11.0	0.30	2.91	3.45	3.27	9.5	8.0	A++
14	18	18	—	—	50	2.66	3.42	3.42	—	—	3.0	9.50	11.0	0.30	2.91	3.45	3.27	9.5	8.0	A++
18	18	18	—	—	54	3.17	3.17	3.17	—	—	3.0	9.50	11.0	0.30	2.91	3.45	3.27	9.5	8.0	A++
7	7	7	7	—	28	2.00	2.00	2.00	2.00	—	3.0	8.00	10.0	0.30	2.11	2.88	3.80	8.0	8.5	A+++

Combination of indoor unit						Rated capacity for each indoor unit (kW)					Total capacity (kW)			Input power (kW)			EER (W/W)	Seasonal data		
Room					Total	Room					Min.	Rated	Max.	Min.	Rated	Max.		Pdesign (kW)	SEER (kWh/kWh)	Energy efficiency class
1	2	3	4	5		1	2	3	4	5										
7	7	7	14	—	35	1.90	1.90	1.90	3.80	—	3.0	9.50	11.0	0.30	2.69	3.45	3.53	9.5	8.3	A++
7	7	7	18	—	39	1.71	1.71	1.71	4.37	—	3.0	9.50	11.0	0.30	2.69	3.45	3.53	9.5	8.3	A++
7	7	7	22	—	43	1.55	1.55	1.55	4.85	—	3.0	9.50	11.0	0.30	2.69	3.45	3.53	9.5	8.3	A++
7	7	7	24	—	45	1.48	1.48	1.48	5.06	—	3.0	9.50	11.0	0.30	2.69	3.45	3.53	9.5	8.3	A++
7	7	9	9	—	32	2.00	2.00	2.50	2.50	—	3.0	9.00	11.0	0.30	2.49	3.45	3.62	9.0	8.4	A++
7	7	9	12	—	35	1.90	1.90	2.44	3.26	—	3.0	9.50	11.0	0.30	2.69	3.45	3.53	9.5	8.3	A++
7	7	9	14	—	37	1.80	1.80	2.31	3.59	—	3.0	9.50	11.0	0.30	2.69	3.45	3.53	9.5	8.3	A++
7	7	9	18	—	41	1.62	1.62	2.09	4.17	—	3.0	9.50	11.0	0.30	2.69	3.45	3.53	9.5	8.3	A++
7	7	9	22	—	45	1.48	1.48	1.90	4.64	—	3.0	9.50	11.0	0.30	2.69	3.45	3.53	9.5	8.3	A++
7	7	9	24	—	47	1.41	1.41	1.82	4.86	—	3.0	9.50	11.0	0.30	2.69	3.45	3.53	9.5	8.3	A++
7	7	12	12	—	38	1.75	1.75	3.00	3.00	—	3.0	9.50	11.0	0.30	2.69	3.45	3.53	9.5	8.3	A++
7	7	12	14	—	40	1.66	1.66	2.85	3.33	—	3.0	9.50	11.0	0.30	2.69	3.45	3.53	9.5	8.3	A++
7	7	12	18	—	44	1.51	1.51	2.59	3.89	—	3.0	9.50	11.0	0.30	2.69	3.45	3.53	9.5	8.3	A++
7	7	12	22	—	48	1.39	1.39	2.38	4.34	—	3.0	9.50	11.0	0.30	2.69	3.45	3.53	9.5	8.3	A++
7	7	12	24	—	50	1.33	1.33	2.28	4.56	—	3.0	9.50	11.0	0.30	2.69	3.45	3.53	9.5	8.3	A++
7	7	14	14	—	42	1.58	1.58	3.17	3.17	—	3.0	9.50	11.0	0.30	2.69	3.45	3.53	9.5	8.3	A++
7	7	14	18	—	46	1.45	1.45	2.89	3.71	—	3.0	9.50	11.0	0.30	2.69	3.45	3.53	9.5	8.3	A++
7	7	14	22	—	50	1.33	1.33	2.66	4.18	—	3.0	9.50	11.0	0.30	2.69	3.45	3.53	9.5	8.3	A++
7	7	14	24	—	52	1.28	1.28	2.56	4.38	—	3.0	9.50	11.0	0.30	2.69	3.45	3.53	9.5	8.3	A++
7	7	18	18	—	50	1.33	1.33	3.42	3.42	—	3.0	9.50	11.0	0.30	2.69	3.45	3.53	9.5	8.3	A++
7	9	9	9	—	34	2.00	2.50	2.50	2.50	—	3.0	9.50	11.0	0.30	2.69	3.45	3.53	9.5	8.3	A++
7	9	9	12	—	37	1.80	2.31	2.31	3.08	—	3.0	9.50	11.0	0.30	2.69	3.45	3.53	9.5	8.3	A++
7	9	9	14	—	39	1.71	2.19	2.19	3.41	—	3.0	9.50	11.0	0.30	2.69	3.45	3.53	9.5	8.3	A++
7	9	9	18	—	43	1.54	1.99	1.99	3.98	—	3.0	9.50	11.0	0.30	2.69	3.45	3.53	9.5	8.3	A++
7	9	9	22	—	47	1.41	1.82	1.82	4.45	—	3.0	9.50	11.0	0.30	2.69	3.45	3.53	9.5	8.3	A++
7	9	9	24	—	49	1.36	1.74	1.74	4.66	—	3.0	9.50	11.0	0.30	2.69	3.45	3.53	9.5	8.3	A++
7	9	12	12	—	40	1.66	2.14	2.85	2.85	—	3.0	9.50	11.0	0.30	2.69	3.45	3.53	9.5	8.3	A++
7	9	12	14	—	42	1.58	2.04	2.71	3.17	—	3.0	9.50	11.0	0.30	2.69	3.45	3.53	9.5	8.3	A++
7	9	12	18	—	46	1.44	1.86	2.48	3.72	—	3.0	9.50	11.0	0.30	2.69	3.45	3.53	9.5	8.3	A++
7	9	12	22	—	50	1.33	1.71	2.28	4.18	—	3.0	9.50	11.0	0.30	2.69	3.45	3.53	9.5	8.3	A++
7	9	12	24	—	52	1.28	1.64	2.19	4.39	—	3.0	9.50	11.0	0.30	2.69	3.45	3.53	9.5	8.3	A++
7	9	14	14	—	44	1.51	1.95	3.02	3.02	—	3.0	9.50	11.0	0.30	2.69	3.45	3.53	9.5	8.3	A++
7	9	14	18	—	48	1.39	1.78	2.77	3.56	—	3.0	9.50	11.0	0.30	2.69	3.45	3.53	9.5	8.3	A++
7	9	14	22	—	52	1.28	1.64	2.56	4.02	—	3.0	9.50	11.0	0.30	2.69	3.45	3.53	9.5	8.3	A++
7	9	14	24	—	54	1.23	1.58	2.46	4.23	—	3.0	9.50	11.0	0.30	2.69	3.45	3.53	9.5	8.3	A++
7	9	18	18	—	52	1.28	1.64	3.29	3.29	—	3.0	9.50	11.0	0.30	2.69	3.45	3.53	9.5	8.3	A++
7	12	12	12	—	43	1.55	2.65	2.65	2.65	—	3.0	9.50	11.0	0.30	2.69	3.45	3.53	9.5	8.3	A++
7	12	12	14	—	45	1.48	2.53	2.53	2.96	—	3.0	9.50	11.0	0.30	2.69	3.45	3.53	9.5	8.3	A++
7	12	12	18	—	49	1.35	2.33	2.33	3.49	—	3.0	9.50	11.0	0.30	2.69	3.45	3.53	9.5	8.3	A++
7	12	14	14	—	47	1.41	2.43	2.83	2.83	—	3.0	9.50	11.0	0.30	2.69	3.45	3.53	9.5	8.3	A++
7	12	14	18	—	51	1.30	2.24	2.61	3.35	—	3.0	9.50	11.0	0.30	2.69	3.45	3.53	9.5	8.3	A++
7	14	14	14	—	49	1.37	2.71	2.71	2.71	—	3.0	9.50	11.0	0.30	2.69	3.45	3.53	9.5	8.3	A++
7	14	14	18	—	53	1.25	2.51	2.51	3.23	—	3.0	9.50	11.0	0.30	2.69	3.45	3.53	9.5	8.3	A++
9	9	9	9	—	36	2.38	2.38	2.38	2.38	—	3.0	9.50	11.0	0.30	2.69	3.45	3.53	9.5	8.3	A++
9	9	9	12	—	39	2.19	2.19	2.19	2.93	—	3.0	9.50	11.0	0.30	2.69	3.45	3.53	9.5	8.3	A++
9	9	9	14	—	41	2.09	2.09	2.09	3.23	—	3.0	9.50	11.0	0.30	2.69	3.45	3.53	9.5	8.3	A++
9	9	9	18	—	45	1.90	1.90	1.90	3.80	—	3.0	9.50	11.0	0.30	2.69	3.45	3.53	9.5	8.3	A++
9	9	9	22	—	49	1.74	1.74	1.74	4.28	—	3.0	9.50	11.0	0.30	2.69	3.45	3.53	9.5	8.3	A++
9	9	9	24	—	51	1.68	1.68	1.68	4.46	—	3.0	9.50	11.0	0.30	2.69	3.45	3.53	9.5	8.3	A++
9	9	12	12	—	42	2.04	2.04	2.71	2.71	—	3.0	9.50	11.0	0.30	2.69	3.45	3.53	9.5	8.3	A++
9	9	12	14	—	44	1.94	1.94	2.59	3.03	—	3.0	9.50	11.0	0.30	2.69	3.45	3.53	9.5	8.3	A++
9	9	12	18	—	48	1.78	1.78	2.38	3.56	—	3.0	9.50	11.0	0.30	2.69	3.45	3.53	9.5	8.3	A++
9	9	12	22	—	52	1.64	1.64	2.19	4.03	—	3.0	9.50	11.0	0.30	2.69	3.45	3.53	9.5	8.3	A++
9	9	12	24	—	54	1.58	1.58	2.11	4.23	—	3.0	9.50	11.0	0.30	2.69	3.45	3.53	9.5	8.3	A++
9	9	14	14	—	46	1.86	1.86	2.89	2.89	—	3.0	9.50	11.0	0.30	2.69	3.45	3.53	9.5	8.3	A++
9	9	14	18	—	50	1.71	1.71	2.66	3.42	—	3.0	9.50	11.0	0.30	2.69	3.45	3.53	9.5	8.3	A++
9	9	18	18	—	54	1.58	1.58	3.17	3.17	—	3.0	9.50	11.0	0.30	2.69	3.45	3.53	9.5	8.3	A++
9	12	12	12	—	45	1.91	2.53	2.53	2.53	—	3.0	9.50	11.0	0.30	2.69	3.45	3.53	9.5	8.3	A++
9	12	12	14	—	47	1.81	2.43	2.43	2.83	—	3.0	9.50	11.0	0.30	2.69	3.45	3.53	9.5	8.3	A++
9	12	12	18	—	51	1.67	2.24	2.24	3.35	—	3.0	9.50	11.0	0.30	2.69	3.45	3.53	9.5	8.3	A++
9	12	14	14	—	49	1.74	2.34	2.71	2.71	—	3.0	9.50	11.0	0.30	2.69	3.45	3.53	9.5	8.3	A++
9	14	14	18	—	53	1.61	2.15	2.51	3.23	—	3.0	9.50	11.0	0.30	2.69	3.45	3.53	9.5	8.3	A++
9	14	14	14	—	51	1.67	2.61	2.61	2.61	—	3.0	9.50	11.0	0.30	2.69	3.45	3.53	9.5	8.3	A++
12	12	12	12	—	48	2.38	2.38	2.38	2.38	—	3.0	9.50	11.0	0.30	2.69	3.45	3.53	9.5	8.3	A++
12	12	12	14	—	50	2.28	2.28	2.28	2.66	—	3.0	9.50	11.0	0.30	2.69	3.45	3.53	9.5	8.3	A++
12	12	12	18	—	54	2.11	2.11	2.11	3.17	—	3.0	9.50	11.0	0.30	2.69	3.45	3.53	9.5	8.3	A++
12	12	14	14	—	52	2.19	2.19	2.56	2.56	—	3.0	9.50	11.0	0.30	2.69	3.45	3.53	9.5	8.3	A++
12	14	14	14	—	54	2.12	2.46	2.46	2.46	—	3.0	9.50	11.0	0.30	2.69	3.45	3.53	9.5	8.3	A++
7	7	7	7	7	35	1.90	1.90	1.90	1.90	1.90	3.0	9.50	11.0	0.30	2.50	3.45	3.80	9.5	8.5	A+++
7	7	7	7	9	37	1.80	1.80	1.80	1.80	2.30	3.0	9.50	11.0	0.30	2.50	3.45	3.80	9.5	8.5	A+++
7	7	7	7	12	40	1.66	1.66	1.66	1.66	2.86	3.0	9.50								

Combination of indoor unit						Rated capacity for each indoor unit (kW)					Total capacity (kW)			Input power (kW)			EER (W/W)	Seasonal data		
Room					Total	Room					Min.	Rated	Max.	Min.	Rated	Max.		Pdesign (kW)	SEER (kWh/kWh)	Energy efficiency class
1	2	3	4	5		1	2	3	4	5										
7	7	9	9	18	50	1.33	1.33	1.71	1.71	3.42	3.0	9.50	11.0	0.30	2.50	3.45	3.80	9.5	8.5	A+++
7	7	9	9	22*	32	1.23	1.23	1.58	1.58	3.88	3.0	9.50	11.0	0.30	2.50	3.45	3.80	9.5	8.5	A+++
7	7	9	12	12	47	1.41	1.41	1.82	2.43	2.43	3.0	9.50	11.0	0.30	2.50	3.45	3.80	9.5	8.5	A+++
7	7	9	12	14	49	1.36	1.36	1.74	2.33	2.71	3.0	9.50	11.0	0.30	2.50	3.45	3.80	9.5	8.5	A+++
7	7	9	12	18	53	1.25	1.25	1.61	2.15	3.24	3.0	9.50	11.0	0.30	2.50	3.45	3.80	9.5	8.5	A+++
7	7	9	14	14	51	1.30	1.30	1.68	2.61	2.61	3.0	9.50	11.0	0.30	2.50	3.45	3.80	9.5	8.5	A+++
7	7	12	12	12	50	1.33	1.33	2.28	2.28	2.28	3.0	9.50	11.0	0.30	2.50	3.45	3.80	9.5	8.5	A+++
7	7	12	12	14	52	1.28	1.28	2.19	2.19	2.56	3.0	9.50	11.0	0.30	2.50	3.45	3.80	9.5	8.5	A+++
7	7	12	14	14	54	1.23	1.23	2.12	2.46	2.46	3.0	9.50	11.0	0.30	2.50	3.45	3.80	9.5	8.5	A+++
7	9	9	9	9	43	1.54	1.99	1.99	1.99	1.99	3.0	9.50	11.0	0.30	2.50	3.45	3.80	9.5	8.5	A+++
7	9	9	9	12	46	1.44	1.86	1.86	1.86	2.48	3.0	9.50	11.0	0.30	2.50	3.45	3.80	9.5	8.5	A+++
7	9	9	9	14	48	1.39	1.78	1.78	1.78	2.77	3.0	9.50	11.0	0.30	2.50	3.45	3.80	9.5	8.5	A+++
7	9	9	9	18	52	1.28	1.64	1.64	1.64	3.30	3.0	9.50	11.0	0.30	2.50	3.45	3.80	9.5	8.5	A+++
7	9	9	12	12	49	1.36	1.74	1.74	2.33	2.33	3.0	9.50	11.0	0.30	2.50	3.45	3.80	9.5	8.5	A+++
7	9	9	12	14	51	1.29	1.68	1.68	2.24	2.61	3.0	9.50	11.0	0.30	2.50	3.45	3.80	9.5	8.5	A+++
7	9	9	14	14	53	1.26	1.61	1.61	2.51	2.51	3.0	9.50	11.0	0.30	2.50	3.45	3.80	9.5	8.5	A+++
7	9	12	12	12	52	1.28	1.65	2.19	2.19	2.19	3.0	9.50	11.0	0.30	2.50	3.45	3.80	9.5	8.5	A+++
7	9	12	12	14	54	1.23	1.58	2.11	2.11	2.47	3.0	9.50	11.0	0.30	2.50	3.45	3.80	9.5	8.5	A+++
9	9	9	9	9	45	1.90	1.90	1.90	1.90	1.90	3.0	9.50	11.0	0.30	2.50	3.45	3.80	9.5	8.5	A+++
9	9	9	9	12	48	1.78	1.78	1.78	1.78	2.38	3.0	9.50	11.0	0.30	2.50	3.45	3.80	9.5	8.5	A+++
9	9	9	9	14	50	1.71	1.71	1.71	1.71	2.66	3.0	9.50	11.0	0.30	2.50	3.45	3.80	9.5	8.5	A+++
9	9	9	9	18	54	1.58	1.58	1.58	1.58	3.18	3.0	9.50	11.0	0.30	2.50	3.45	3.80	9.5	8.5	A+++
9	9	9	12	12	51	1.68	1.68	1.68	2.23	2.23	3.0	9.50	11.0	0.30	2.50	3.45	3.80	9.5	8.5	A+++
9	9	9	12	14	53	1.61	1.61	1.61	2.15	2.52	3.0	9.50	11.0	0.30	2.50	3.45	3.80	9.5	8.5	A+++
9	9	12	12	12	54	1.57	1.57	2.12	2.12	2.12	3.0	9.50	11.0	0.30	2.50	3.45	3.80	9.5	8.5	A+++

OUTDOOR UNIT
AOYG36KBT5

OUTDOOR UNIT
AOYG36KBT5

NOTES:

- 7: 7,000 Btu/h, 9: 9,000 Btu/h, 12: 12,000 Btu/h, 14: 14,000 Btu/h, 18: 18,000 Btu/h, 24: 24,000 Btu/h
- Values mentioned in the table are based on the following conditions:
 - Power source of specifications: 230 V
 - Pipe length: 5 m, Height difference: 0 m (Outdoor unit—Indoor unit)
 - Cooling: Indoor temperature of 27 °CDB/19 °CWB, and outdoor temperature of 35 °CDB.
- 2 or more indoor units should be connected.
- The total ability of connected a indoor unit is from 27,000 Btu up to 54,000 Btu.
- *: As for the 22 model, wall-mounted type indoor unit is only connectable.

● Heating

Combination of indoor unit						Rated capacity for each indoor unit (kW)					Total capacity (kW)			Input power (kW)			COP (W/W)	Seasonal data		
Room					Total	Room					Min.	Rated	Max.	Min.	Rated	Max.		Pdesign (kW)	SCOP (kWh/kWh)	Energy efficiency class
1	2	3	4	5		1	2	3	4	5										
7	24	—	—	—	31	2.39	8.21	—	—	—	3.5	10.60	12.0	0.25	2.65	3.25	4.00	7.0	4.3	A+
9	22	—	—	—	31	3.00	7.20	—	—	—	3.5	10.20	12.0	0.25	2.52	3.25	4.04	6.8	4.3	A+
9	24	—	—	—	33	2.89	7.71	—	—	—	3.5	10.60	12.0	0.25	2.65	3.25	4.00	7.0	4.3	A+
12	22	—	—	—	34	3.74	6.86	—	—	—	3.5	10.60	12.0	0.25	2.65	3.25	4.00	7.0	4.3	A+
12	24	—	—	—	36	3.53	7.07	—	—	—	3.5	10.60	12.0	0.25	2.65	3.25	4.00	7.0	4.3	A+
14	22	—	—	—	36	4.12	6.48	—	—	—	3.5	10.60	12.0	0.25	2.65	3.25	4.00	7.0	4.3	A+
14	24	—	—	—	38	3.91	6.69	—	—	—	3.5	10.60	12.0	0.25	2.65	3.25	4.00	7.0	4.3	A+
18	18	—	—	—	36	5.30	5.30	—	—	—	3.5	10.60	12.0	0.25	2.65	3.25	4.00	7.0	4.3	A+
18	22	—	—	—	40	4.77	5.83	—	—	—	3.5	10.60	12.0	0.25	2.65	3.25	4.00	7.0	4.3	A+
18	24	—	—	—	42	4.54	6.06	—	—	—	3.5	10.60	12.0	0.25	2.65	3.25	4.00	7.0	4.3	A+
22	22	—	—	—	44	5.30	5.30	—	—	—	3.5	10.60	12.0	0.25	2.65	3.25	4.00	7.0	4.3	A+
22	24	—	—	—	46	5.07	5.53	—	—	—	3.5	10.60	12.0	0.25	2.65	3.25	4.00	7.0	4.3	A+
24	24	—	—	—	48	5.30	5.30	—	—	—	3.5	10.60	12.0	0.25	2.65	3.25	4.00	7.0	4.3	A+
7	7	14	—	—	28	2.40	2.40	4.80	—	—	3.5	9.60	11.2	0.25	2.25	2.87	4.26	6.5	4.5	A+
7	7	18	—	—	32	2.32	2.32	5.96	—	—	3.5	10.60	12.0	0.25	2.54	3.25	4.18	7.0	4.4	A+
7	7	22	—	—	36	2.06	2.06	6.48	—	—	3.5	10.60	12.0	0.25	2.54	3.25	4.18	7.0	4.4	A+
7	7	24	—	—	38	1.95	1.95	6.70	—	—	3.5	10.60	12.0	0.25	2.54	3.25	4.18	7.0	4.4	A+
7	9	12	—	—	28	2.40	3.00	4.20	—	—	3.5	9.60	11.2	0.25	2.25	2.87	4.26	6.5	4.5	A+
7	9	14	—	—	30	2.40	3.00	4.80	—	—	3.5	10.20	12.0	0.25	2.42	3.25	4.21	6.8	4.4	A+
7	9	18	—	—	34	2.18	2.81	5.61	—	—	3.5	10.60	12.0	0.25	2.54	3.25	4.18	7.0	4.4	A+
7	9	22	—	—	38	1.95	2.51	6.14	—	—	3.5	10.60	12.0	0.25	2.54	3.25	4.18	7.0	4.4	A+
7	9	24	—	—	40	1.85	2.39	6.36	—	—	3.5	10.60	12.0	0.25	2.54	3.25	4.18	7.0	4.4	A+
7	12	12	—	—	31	2.40	4.10	4.10	—	—	3.5	10.60	12.0	0.25	2.54	3.25	4.18	7.0	4.4	A+
7	12	14	—	—	33	2.25	3.85	4.50	—	—	3.5	10.60	12.0	0.25	2.54	3.25	4.18	7.0	4.4	A+
7	12	18	—	—	37	2.00	3.44	5.16	—	—	3.5	10.60	12.0	0.25	2.54	3.25	4.18	7.0	4.4	A+
7	12	22	—	—	41	1.81	3.10	5.69	—	—	3.5	10.60	12.0	0.25	2.54	3.25	4.18	7.0	4.4	A+
7	12	24	—	—	43	1.72	2.96	5.92	—	—	3.5	10.60	12.0	0.25	2.54	3.25	4.18	7.0	4.4	A+
7	14	14	—	—	35	2.12	4.24	4.24	—	—	3.5	10.60	12.0	0.25	2.54	3.25	4.18	7.0	4.4	A+
7	14	18	—	—	39	1.90	3.81	4.89	—	—	3.5	10.60	12.0	0.25	2.54	3.25	4.18	7.0	4.4	A+
7	14	22	—	—	43	1.73	3.45	5.42	—	—	3.5	10.60	12.0	0.25	2.54	3.25	4.18	7.0	4.4	A+
7	14	24	—	—	45	1.65	3.30	5.65	—	—	3.5	10.60	12.0	0.25	2.54	3.25	4.18	7.0	4.4	A+
7	18	18	—	—	43	1.72	4.44	4.44	—	—	3.5	10.60	12.0	0.25	2.54	3.25	4.18	7.0	4.4	A+
7	18	22	—	—	47	1.58	4.06	4.96	—	—	3.5	10.60	12.0	0.25	2.54	3.25	4.18	7.0	4.4	A+
7	18	24	—	—	49	1.51	3.89	5.20	—	—	3.5	10.60	12.0	0.25	2.54	3.25	4.18	7.0	4.4	A+
9	9	9	—	—	27	3.00	3.00	3.00	—	—	3.5	9.00	10.8	0.25	2.09	2.70	4.31	6.0	4.5	A+
9	9	12	—	—	30	3.00	3.00	4.20	—	—	3.5	10.20	12.0	0.25	2.42	3.25	4.21	6.8	4.4	A+
9	9	14	—	—	32	2.98	2.98	4.64	—	—	3.5	10.60	12.0	0.25	2.54	3.25	4.18	7.0	4.4	A+
9	9	18	—	—	36	2.65	2.65	5.30	—	—	3.5	10.60	12.0	0.25	2.54	3.25	4.18	7.0	4.4	A+
9	9	22	—	—	40	2.39	2.39	5.82	—	—	3.5	10.60	12.0	0.25	2.54	3.25	4.18	7.0	4.4	A+
9	9	24	—	—	42	2.27	2.27	6.06	—	—	3.5	10.60	12.0	0.25	2.54	3.25	4.18	7.0	4.4	A+
9	12	12	—	—	33	2.90	3.85	3.85	—	—	3.5	10.60	12.0	0.25	2.54	3.25	4.18	7.0	4.4	A+
9	12	14	—	—	35	2.73	3.63	4.24	—	—	3.5	10.60	12.0	0.25	2.54	3.25	4.18	7.0	4.4	A+
9	12	18	—	—	39	2.45	3.26	4.89	—	—	3.5	10.60	12.0	0.25	2.54	3.25	4.18	7.0	4.4	A+
9	12	22	—	—	43	2.22	2.96	5.42	—	—	3.5	10.60	12.0	0.25	2.54	3.25	4.18	7.0	4.4	A+
9	12	24	—	—	45	2.12	2.83	5.65	—	—	3.5	10.60	12.0	0.25	2.54	3.25	4.18	7.0	4.4	A+
9	14	14	—	—	37	2.58	4.01	4.01	—	—	3.5	10.60	12.0	0.25	2.54	3.25	4.18	7.0	4.4	A+
9	14	18	—	—	41	2.33	3.62	4.65	—	—	3.5	10.60	12.0	0.25	2.54	3.25	4.18	7.0	4.4	A+
9	14	22	—	—	45	2.12	3.30	5.18	—	—	3.5	10.60	12.0	0.25	2.54	3.25	4.18	7.0	4.4	A+
9	14	24	—	—	47	2.03	3.16	5.41	—	—	3.5	10.60	12.0	0.25	2.54	3.25	4.18	7.0	4.4	A+
9	18	18	—	—	45	2.12	4.24	4.24	—	—	3.5	10.60	12.0	0.25	2.54	3.25	4.18	7.0	4.4	A+
9	18	22	—	—	49	1.95	3.89	4.76	—	—	3.5	10.60	12.0	0.25	2.54	3.25	4.18	7.0	4.4	A+
9	18	24	—	—	51	1.87	3.74	4.99	—	—	3.5	10.60	12.0	0.25	2.54	3.25	4.18	7.0	4.4	A+
12	12	12	—	—	36	3.53	3.53	3.53	—	—	3.5	10.60	12.0	0.25	2.54	3.25	4.18	7.0	4.4	A+
12	12	14	—	—	38	3.35	3.35	3.90	—	—	3.5	10.60	12.0	0.25	2.54	3.25	4.18	7.0	4.4	A+
12	12	18	—	—	42	3.03	3.03	4.54	—	—	3.5	10.60	12.0	0.25	2.54	3.25	4.18	7.0	4.4	A+
12	12	22	—	—	46	2.77	2.77	5.06	—	—	3.5	10.60	12.0	0.25	2.54	3.25	4.18	7.0	4.4	A+
12	12	24	—	—	48	2.65	2.65	5.30	—	—	3.5	10.60	12.0	0.25	2.54	3.25	4.18	7.0	4.4	A+
12	14	14	—	—	40	3.18	3.71	3.71	—	—	3.5	10.60	12.0	0.25	2.54	3.25	4.18	7.0	4.4	A+
12	14	18	—	—	44	2.89	3.37	4.34	—	—	3.5	10.60	12.0	0.25	2.54	3.25	4.18	7.0	4.4	A+
12	14	22	—	—	48	2.65	3.09	4.86	—	—	3.5	10.60	12.0	0.25	2.54	3.25	4.18	7.0	4.4	A+
12	14	24	—	—	50	2.54	2.97	5.09	—	—	3.5	10.60	12.0	0.25	2.54	3.25	4.18	7.0	4.4	A+
12	18	18	—	—	48	2.64	3.98	3.98	—	—	3.5	10.60	12.0	0.25	2.54	3.25	4.18	7.0	4.4	A+
12	18	22	—	—	52	2.45	3.67	4.48	—	—	3.5	10.60	12.0	0.25	2.54	3.25	4.18	7.0	4.4	A+
12	18	24	—	—	54	2.36	3.53	4.71	—	—	3.5	10.60	12.0	0.25	2.54	3.25	4.18	7.0	4.4	A+
14	14	14	—	—	42	3.53	3.53	3.53	—	—	3.5	10.60	12.0	0.25	2.54	3.25	4.18	7.0	4.4	A+
14	14	18	—	—	46	3.23	3.23	4.14	—	—	3.5	10.60	12.0	0.25	2.54	3.25	4.18	7.0	4.4	A+
14	14	22	—	—	50	2.97	2.97	4.66	—	—	3.5	10.60	12.0	0.25	2.54	3.25	4.18	7.0	4.4	A+
14	14	24	—	—	52	2.85	2.85	4.90	—	—	3.5	10.60	12.0	0.25	2.54	3.25	4.18	7.0	4.4	A+
14	18	18	—	—	50	2.96	3.82	3.82	—	—	3.5	10.60	12.0	0.25	2.54	3.25	4.18	7.0	4.4	A+
18	18	18	—	—	54	3.53	3.53	3.53	—	—	3.5	10.60	12.0	0.25	2.54	3.25	4.18	7.0	4.4	A+
7	7	7	7	—	28	2.40	2.40	2.40	2.40	—	3.5	9.60	11.2	0.25	2.17	2.87	4.42	6.5	4.6	A++
7	7	7	9	—	30	2.40	2.40	2.40	3.00	—	3.5	10.20	12.0	0.25	2.33	3.25	4			

Combination of indoor unit					Rated capacity for each indoor unit (kW)					Total capacity (kW)			Input power (kW)			COP (W/W)	Seasonal data			
Room					Total	Room					Min.	Rated	Max.	Min.	Rated		Max.	Pdesign (kW)	SCOP (kWh/kWh)	Energy efficiency class
1	2	3	4	5		1	2	3	4	5										
7	7	12	22	—	48	1.55	1.55	2.64	4.86	—	3.5	10.60	12.0	0.25	2.44	3.25	4.34	7.0	4.5	A+
7	7	12	24	—	50	1.48	1.48	2.54	5.10	—	3.5	10.60	12.0	0.25	2.44	3.25	4.34	7.0	4.5	A+
7	7	14	14	—	42	1.77	1.77	3.53	3.53	—	3.5	10.60	12.0	0.25	2.44	3.25	4.34	7.0	4.5	A+
7	7	14	18	—	46	1.61	1.61	3.23	4.15	—	3.5	10.60	12.0	0.25	2.44	3.25	4.34	7.0	4.5	A+
7	7	14	22	—	50	1.48	1.48	2.97	4.67	—	3.5	10.60	12.0	0.25	2.44	3.25	4.34	7.0	4.5	A+
7	7	14	24	—	52	1.43	1.43	2.85	4.89	—	3.5	10.60	12.0	0.25	2.44	3.25	4.34	7.0	4.5	A+
7	7	18	18	—	50	1.48	1.48	3.82	3.82	—	3.5	10.60	12.0	0.25	2.44	3.25	4.34	7.0	4.5	A+
7	9	9	9	—	34	2.17	2.81	2.81	2.81	—	3.5	10.60	12.0	0.25	2.44	3.25	4.34	7.0	4.5	A+
7	9	9	12	—	37	2.00	2.58	2.58	3.44	—	3.5	10.60	12.0	0.25	2.44	3.25	4.34	7.0	4.5	A+
7	9	9	14	—	39	1.89	2.45	2.45	3.81	—	3.5	10.60	12.0	0.25	2.44	3.25	4.34	7.0	4.5	A+
7	9	9	18	—	43	1.72	2.22	2.22	4.44	—	3.5	10.60	12.0	0.25	2.44	3.25	4.34	7.0	4.5	A+
7	9	9	22	—	47	1.58	2.03	2.03	4.96	—	3.5	10.60	12.0	0.25	2.44	3.25	4.34	7.0	4.5	A+
7	9	9	24	—	49	1.51	1.95	1.95	5.19	—	3.5	10.60	12.0	0.25	2.44	3.25	4.34	7.0	4.5	A+
7	9	12	12	—	40	1.85	2.39	3.18	3.18	—	3.5	10.60	12.0	0.25	2.44	3.25	4.34	7.0	4.5	A+
7	9	12	14	—	42	1.77	2.27	3.03	3.53	—	3.5	10.60	12.0	0.25	2.44	3.25	4.34	7.0	4.5	A+
7	9	12	18	—	46	1.61	2.07	2.77	4.15	—	3.5	10.60	12.0	0.25	2.44	3.25	4.34	7.0	4.5	A+
7	9	12	22	—	50	1.48	1.91	2.54	4.67	—	3.5	10.60	12.0	0.25	2.44	3.25	4.34	7.0	4.5	A+
7	9	12	24	—	52	1.43	1.83	2.45	4.89	—	3.5	10.60	12.0	0.25	2.44	3.25	4.34	7.0	4.5	A+
7	9	14	14	—	44	1.69	2.17	3.37	3.37	—	3.5	10.60	12.0	0.25	2.44	3.25	4.34	7.0	4.5	A+
7	9	14	18	—	48	1.54	1.99	3.09	3.98	—	3.5	10.60	12.0	0.25	2.44	3.25	4.34	7.0	4.5	A+
7	9	14	22	—	52	1.43	1.83	2.85	4.49	—	3.5	10.60	12.0	0.25	2.44	3.25	4.34	7.0	4.5	A+
7	9	14	24	—	54	1.37	1.77	2.75	4.71	—	3.5	10.60	12.0	0.25	2.44	3.25	4.34	7.0	4.5	A+
7	9	18	18	—	52	1.43	1.83	3.67	3.67	—	3.5	10.60	12.0	0.25	2.44	3.25	4.34	7.0	4.5	A+
7	12	12	12	—	43	1.72	2.96	2.96	2.96	—	3.5	10.60	12.0	0.25	2.44	3.25	4.34	7.0	4.5	A+
7	12	12	14	—	45	1.64	2.83	2.83	3.30	—	3.5	10.60	12.0	0.25	2.44	3.25	4.34	7.0	4.5	A+
7	12	12	18	—	49	1.51	2.60	2.60	3.89	—	3.5	10.60	12.0	0.25	2.44	3.25	4.34	7.0	4.5	A+
7	12	14	14	—	47	1.57	2.71	3.16	3.16	—	3.5	10.60	12.0	0.25	2.44	3.25	4.34	7.0	4.5	A+
7	12	14	18	—	51	1.45	2.49	2.91	3.75	—	3.5	10.60	12.0	0.25	2.44	3.25	4.34	7.0	4.5	A+
7	14	14	14	—	49	1.51	3.03	3.03	3.03	—	3.5	10.60	12.0	0.25	2.44	3.25	4.34	7.0	4.5	A+
7	14	14	18	—	53	1.40	2.80	2.80	3.60	—	3.5	10.60	12.0	0.25	2.44	3.25	4.34	7.0	4.5	A+
9	9	9	9	—	36	2.65	2.65	2.65	2.65	—	3.5	10.60	12.0	0.25	2.44	3.25	4.34	7.0	4.5	A+
9	9	9	12	—	39	2.45	2.45	2.45	3.25	—	3.5	10.60	12.0	0.25	2.44	3.25	4.34	7.0	4.5	A+
9	9	9	14	—	41	2.33	2.33	2.33	3.61	—	3.5	10.60	12.0	0.25	2.44	3.25	4.34	7.0	4.5	A+
9	9	9	18	—	45	2.12	2.12	2.12	4.24	—	3.5	10.60	12.0	0.25	2.44	3.25	4.34	7.0	4.5	A+
9	9	9	22	—	49	1.95	1.95	1.95	4.75	—	3.5	10.60	12.0	0.25	2.44	3.25	4.34	7.0	4.5	A+
9	9	9	24	—	51	1.87	1.87	1.87	4.99	—	3.5	10.60	12.0	0.25	2.44	3.25	4.34	7.0	4.5	A+
9	9	12	12	—	42	2.27	2.27	3.03	3.03	—	3.5	10.60	12.0	0.25	2.44	3.25	4.34	7.0	4.5	A+
9	9	12	14	—	44	2.17	2.17	2.89	3.37	—	3.5	10.60	12.0	0.25	2.44	3.25	4.34	7.0	4.5	A+
9	9	12	18	—	48	1.99	1.99	2.64	3.98	—	3.5	10.60	12.0	0.25	2.44	3.25	4.34	7.0	4.5	A+
9	9	12	22	—	52	1.83	1.83	2.45	4.49	—	3.5	10.60	12.0	0.25	2.44	3.25	4.34	7.0	4.5	A+
9	9	12	24	—	54	1.77	1.77	2.35	4.71	—	3.5	10.60	12.0	0.25	2.44	3.25	4.34	7.0	4.5	A+
9	9	14	14	—	46	2.07	2.07	3.23	3.23	—	3.5	10.60	12.0	0.25	2.44	3.25	4.34	7.0	4.5	A+
9	9	14	18	—	50	1.91	1.91	2.96	3.82	—	3.5	10.60	12.0	0.25	2.44	3.25	4.34	7.0	4.5	A+
9	9	18	18	—	54	1.77	1.77	3.53	3.53	—	3.5	10.60	12.0	0.25	2.44	3.25	4.34	7.0	4.5	A+
9	12	12	12	—	45	2.11	2.83	2.83	2.83	—	3.5	10.60	12.0	0.25	2.44	3.25	4.34	7.0	4.5	A+
9	12	12	14	—	47	2.02	2.71	2.71	3.16	—	3.5	10.60	12.0	0.25	2.44	3.25	4.34	7.0	4.5	A+
9	12	12	18	—	51	1.87	2.49	2.49	3.75	—	3.5	10.60	12.0	0.25	2.44	3.25	4.34	7.0	4.5	A+
9	12	14	14	—	49	1.94	2.60	3.03	3.03	—	3.5	10.60	12.0	0.25	2.44	3.25	4.34	7.0	4.5	A+
9	12	14	18	—	53	1.80	2.40	2.80	3.60	—	3.5	10.60	12.0	0.25	2.44	3.25	4.34	7.0	4.5	A+
9	14	14	14	—	51	1.87	2.91	2.91	2.91	—	3.5	10.60	12.0	0.25	2.44	3.25	4.34	7.0	4.5	A+
12	12	12	12	—	48	2.65	2.65	2.65	2.65	—	3.5	10.60	12.0	0.25	2.44	3.25	4.34	7.0	4.5	A+
12	12	12	14	—	50	2.54	2.54	2.54	2.98	—	3.5	10.60	12.0	0.25	2.44	3.25	4.34	7.0	4.5	A+
12	12	12	18	—	54	2.36	2.36	2.36	3.52	—	3.5	10.60	12.0	0.25	2.44	3.25	4.34	7.0	4.5	A+
12	12	14	14	—	52	2.45	2.45	2.85	2.85	—	3.5	10.60	12.0	0.25	2.44	3.25	4.34	7.0	4.5	A+
12	14	14	14	—	54	2.35	2.75	2.75	2.75	—	3.5	10.60	12.0	0.25	2.44	3.25	4.34	7.0	4.5	A+
7	7	7	7	7	35	2.12	2.12	2.12	2.12	2.12	3.5	10.60	12.0	0.25	2.36	3.25	4.50	7.0	4.6	A++
7	7	7	7	9	37	2.01	2.01	2.01	2.01	2.56	3.5	10.60	12.0	0.25	2.36	3.25	4.50	7.0	4.6	A++
7	7	7	7	12	40	1.86	1.86	1.86	1.86	3.16	3.5	10.60	12.0	0.25	2.36	3.25	4.50	7.0	4.6	A++
7	7	7	7	14	42	1.77	1.77	1.77	1.77	3.52	3.5	10.60	12.0	0.25	2.36	3.25	4.50	7.0	4.6	A++
7	7	7	7	18	46	1.61	1.61	1.61	1.61	4.16	3.5	10.60	12.0	0.25	2.36	3.25	4.50	7.0	4.6	A++
7	7	7	7	22*	28	1.48	1.48	1.48	1.48	4.68	3.5	10.60	12.0	0.25	2.36	3.25	4.50	7.0	4.6	A++
7	7	7	7	24	52	1.43	1.43	1.43	1.43	4.88	3.5	10.60	12.0	0.25	2.36	3.25	4.50	7.0	4.6	A++
7	7	7	9	9	39	1.90	1.90	1.90	2.45	2.45	3.5	10.60	12.0	0.25	2.36	3.25	4.50	7.0	4.6	A++
7	7	7	9	12	42	1.77	1.77	1.77	2.26	3.03	3.5	10.60	12.0	0.25	2.36	3.25	4.50	7.0	4.6	A++
7	7	7	9	14	44	1.69	1.69	1.69	2.16	3.37	3.5	10.60	12.0	0.25	2.36	3.25	4.50	7.0	4.6	A++
7	7	7	9	18	48	1.55	1.55	1.55	1.99	3.96	3.5	10.60	12.0	0.25	2.36	3.25	4.50	7.0	4.6	A++
7	7	7	9	22*	30	1.43	1.43	1.43	1.83	4.48	3.5	10.60	12.0	0.25	2.36	3.25	4.50	7.0	4.6	A++
7	7	7	9	24	54	1.37	1.37	1.37	1.77	4.72	3.5	10.60	12.0	0.25	2.36	3.25	4.50	7.0	4.6	A++
7	7	7	12	12	45	1.64	1.64	1.64	2.84	2.84	3.5	10.60	12.0	0.25	2.36	3.25	4.50	7.0	4.6	A++
7	7	7	12	14	47	1.58	1.58	1.58	2.70	3.16	3.5	10.60	12.0	0.25	2.36	3.25	4.50	7.0	4.6	A++
7	7	7	12	18	51</															

Combination of indoor unit						Rated capacity for each indoor unit (kW)					Total capacity (kW)			Input power (kW)			COP (W/W)	Seasonal data		
Room					Total	Room					Min.	Rated	Max.	Min.	Rated	Max.		Pdesign (kW)	SCOP (kWh/kWh)	Energy efficiency class
1	2	3	4	5		1	2	3	4	5										
7	9	9	12	12	49	1.50	1.95	1.95	2.60	2.60	3.5	10.60	12.0	0.25	2.36	3.25	4.50	7.0	4.6	A++
7	9	9	12	14	51	1.45	1.87	1.87	2.49	2.92	3.5	10.60	12.0	0.25	2.36	3.25	4.50	7.0	4.6	A++
7	9	9	14	14	53	1.40	1.80	1.80	2.80	2.80	3.5	10.60	12.0	0.25	2.36	3.25	4.50	7.0	4.6	A++
7	9	12	12	12	52	1.42	1.83	2.45	2.45	2.45	3.5	10.60	12.0	0.25	2.36	3.25	4.50	7.0	4.6	A++
7	9	12	12	14	54	1.36	1.77	2.36	2.36	2.75	3.5	10.60	12.0	0.25	2.36	3.25	4.50	7.0	4.6	A++
9	9	9	9	9	45	2.12	2.12	2.12	2.12	2.12	3.5	10.60	12.0	0.25	2.36	3.25	4.50	7.0	4.6	A++
9	9	9	9	12	48	1.99	1.99	1.99	1.99	2.64	3.5	10.60	12.0	0.25	2.36	3.25	4.50	7.0	4.6	A++
9	9	9	9	14	50	1.91	1.91	1.91	1.91	2.96	3.5	10.60	12.0	0.25	2.36	3.25	4.50	7.0	4.6	A++
9	9	9	9	18	54	1.77	1.77	1.77	1.77	3.52	3.5	10.60	12.0	0.25	2.36	3.25	4.50	7.0	4.6	A++
9	9	9	12	12	51	1.88	1.88	1.88	2.48	2.48	3.5	10.60	12.0	0.25	2.36	3.25	4.50	7.0	4.6	A++
9	9	9	12	14	53	1.80	1.80	1.80	2.40	2.80	3.5	10.60	12.0	0.25	2.36	3.25	4.50	7.0	4.6	A++
9	9	12	12	12	54	1.76	1.76	2.36	2.36	2.36	3.5	10.60	12.0	0.25	2.36	3.25	4.50	7.0	4.6	A++

NOTES:

- 7: 7,000 Btu/h, 9: 9,000 Btu/h, 12: 12,000 Btu/h, 14: 14,000 Btu/h, 18: 18,000 Btu/h, 24: 24,000 Btu/h
- Values mentioned in the table are based on the following conditions:
 - Power source of specifications: 230 V
 - Pipe length: 5 m, Height difference: 0 m (Outdoor unit—Indoor unit)
 - Heating: Indoor temperature of 20 °CDB, and outdoor temperature of 7 °CDB/6 °CWB.
- 2 or more indoor units should be connected.
- The total ability of connected a indoor unit is from 27,000 Btu up to 54,000 Btu.
- *: As for the 22 model, wall-mounted type indoor unit is only connectable.

6-2. Cooling capacity

NOTE: Values mentioned in the table are calculated based on the maximum capacity.

Model: AOYG36KBTA5

Indoor unit connect- ing capacity	Outdoor temperature	Indoor temperature											
		18.0 °CDB		21.0 °CDB		23.0 °CDB		27.0 °CDB		29.0 °CDB		32.0 °CDB	
		12.0 °CWB		15.0 °CWB		16.0 °CWB		19.0 °CWB		21.0 °CWB		23.0 °CWB	
kBtu/h	°CDB	TC	IP	TC	IP	TC	IP	TC	IP	TC	IP	TC	IP
54	-10.0	8.6	2.31	9.7	2.36	10.3	2.37	11.0	2.40	11.8	2.43	12.1	2.44
	0.0	8.6	2.08	9.7	2.12	10.3	2.13	11.0	2.16	11.8	2.18	12.1	2.19
	5.0	8.6	1.94	9.7	1.97	10.3	1.99	11.0	2.01	11.8	2.04	12.1	2.05
	10.0	8.6	1.88	9.7	1.91	10.3	1.93	11.0	1.95	11.8	1.97	12.1	1.98
	15.0	8.6	1.98	9.7	2.01	10.3	2.03	11.0	2.05	11.8	2.08	12.1	2.09
	20.0	8.6	1.97	9.7	2.00	10.3	2.02	11.0	2.04	11.8	2.07	12.1	2.08
	25.0	8.6	2.23	9.7	2.27	10.3	2.29	11.0	2.31	11.8	2.34	12.1	2.35
	30.0	8.6	2.68	9.7	2.72	10.3	2.75	11.0	2.78	11.8	2.81	12.1	2.82
	35.0	8.6	3.23	9.7	3.29	10.3	3.31	11.0	3.35	11.8	3.39	12.1	3.41
	40.0	6.4	2.40	7.2	2.45	7.6	2.47	8.2	2.49	8.7	2.52	9.0	2.54
46.0	4.2	1.58	4.7	1.61	5.0	1.62	5.3	1.64	5.7	1.66	5.9	1.67	
53	-10.0	8.6	2.31	9.7	2.36	10.3	2.37	11.0	2.40	11.8	2.43	12.1	2.44
	0.0	8.6	2.08	9.7	2.12	10.3	2.13	11.0	2.16	11.8	2.18	12.1	2.19
	5.0	8.6	1.94	9.7	1.97	10.3	1.99	11.0	2.01	11.8	2.04	12.1	2.05
	10.0	8.6	1.88	9.7	1.91	10.3	1.93	11.0	1.95	11.8	1.97	12.1	1.98
	15.0	8.6	1.98	9.7	2.01	10.3	2.03	11.0	2.05	11.8	2.08	12.1	2.09
	20.0	8.6	1.97	9.7	2.00	10.3	2.02	11.0	2.04	11.8	2.07	12.1	2.08
	25.0	8.6	2.23	9.7	2.27	10.3	2.29	11.0	2.31	11.8	2.34	12.1	2.35
	30.0	8.6	2.68	9.7	2.72	10.3	2.75	11.0	2.78	11.8	2.81	12.1	2.82
	35.0	8.6	3.23	9.7	3.29	10.3	3.31	11.0	3.35	11.8	3.39	12.1	3.41
	40.0	6.4	2.40	7.2	2.45	7.6	2.47	8.2	2.49	8.7	2.52	9.0	2.54
46.0	4.2	1.58	4.7	1.61	5.0	1.62	5.3	1.64	5.7	1.66	5.9	1.67	
52	-10.0	8.6	2.31	9.7	2.36	10.3	2.37	11.0	2.40	11.8	2.43	12.1	2.44
	0.0	8.6	2.08	9.7	2.12	10.3	2.13	11.0	2.16	11.8	2.18	12.1	2.19
	5.0	8.6	1.94	9.7	1.97	10.3	1.99	11.0	2.01	11.8	2.04	12.1	2.05
	10.0	8.6	1.88	9.7	1.91	10.3	1.93	11.0	1.95	11.8	1.97	12.1	1.98
	15.0	8.6	1.98	9.7	2.01	10.3	2.03	11.0	2.05	11.8	2.08	12.1	2.09
	20.0	8.6	1.97	9.7	2.00	10.3	2.02	11.0	2.04	11.8	2.07	12.1	2.08
	25.0	8.6	2.23	9.7	2.27	10.3	2.29	11.0	2.31	11.8	2.34	12.1	2.35
	30.0	8.6	2.68	9.7	2.72	10.3	2.75	11.0	2.78	11.8	2.81	12.1	2.82
	35.0	8.6	3.23	9.7	3.29	10.3	3.31	11.0	3.35	11.8	3.39	12.1	3.41
	40.0	6.4	2.40	7.2	2.45	7.6	2.47	8.2	2.49	8.7	2.52	9.0	2.54
46.0	4.2	1.58	4.7	1.61	5.0	1.62	5.3	1.64	5.7	1.66	5.9	1.67	
51	-10.0	8.6	2.31	9.7	2.36	10.3	2.37	11.0	2.40	11.8	2.43	12.1	2.44
	0.0	8.6	2.08	9.7	2.12	10.3	2.13	11.0	2.16	11.8	2.18	12.1	2.19
	5.0	8.6	1.94	9.7	1.97	10.3	1.99	11.0	2.01	11.8	2.04	12.1	2.05
	10.0	8.6	1.88	9.7	1.91	10.3	1.93	11.0	1.95	11.8	1.97	12.1	1.98
	15.0	8.6	1.98	9.7	2.01	10.3	2.03	11.0	2.05	11.8	2.08	12.1	2.09
	20.0	8.6	1.97	9.7	2.00	10.3	2.02	11.0	2.04	11.8	2.07	12.1	2.08
	25.0	8.6	2.23	9.7	2.27	10.3	2.29	11.0	2.31	11.8	2.34	12.1	2.35
	30.0	8.6	2.68	9.7	2.72	10.3	2.75	11.0	2.78	11.8	2.81	12.1	2.82
	35.0	8.6	3.23	9.7	3.29	10.3	3.31	11.0	3.35	11.8	3.39	12.1	3.41
	40.0	6.4	2.40	7.2	2.45	7.6	2.47	8.2	2.49	8.7	2.52	9.0	2.54
46.0	4.2	1.58	4.7	1.61	5.0	1.62	5.3	1.64	5.7	1.66	5.9	1.67	
50	-10.0	8.6	2.31	9.7	2.36	10.3	2.37	11.0	2.40	11.8	2.43	12.1	2.44
	0.0	8.6	2.08	9.7	2.12	10.3	2.13	11.0	2.16	11.8	2.18	12.1	2.19
	5.0	8.6	1.94	9.7	1.97	10.3	1.99	11.0	2.01	11.8	2.04	12.1	2.05
	10.0	8.6	1.88	9.7	1.91	10.3	1.93	11.0	1.95	11.8	1.97	12.1	1.98
	15.0	8.6	1.98	9.7	2.01	10.3	2.03	11.0	2.05	11.8	2.08	12.1	2.09
	20.0	8.6	1.97	9.7	2.00	10.3	2.02	11.0	2.04	11.8	2.07	12.1	2.08
	25.0	8.6	2.23	9.7	2.27	10.3	2.29	11.0	2.31	11.8	2.34	12.1	2.35
	30.0	8.6	2.68	9.7	2.72	10.3	2.75	11.0	2.78	11.8	2.81	12.1	2.82
	35.0	8.6	3.23	9.7	3.29	10.3	3.31	11.0	3.35	11.8	3.39	12.1	3.41
	40.0	6.4	2.40	7.2	2.45	7.6	2.47	8.2	2.49	8.7	2.52	9.0	2.54
46.0	4.2	1.58	4.7	1.61	5.0	1.62	5.3	1.64	5.7	1.66	5.9	1.67	
49	-10.0	8.6	2.31	9.7	2.36	10.3	2.37	11.0	2.40	11.8	2.43	12.1	2.44
	0.0	8.6	2.08	9.7	2.12	10.3	2.13	11.0	2.16	11.8	2.18	12.1	2.19
	5.0	8.6	1.94	9.7	1.97	10.3	1.99	11.0	2.01	11.8	2.04	12.1	2.05
	10.0	8.6	1.88	9.7	1.91	10.3	1.93	11.0	1.95	11.8	1.97	12.1	1.98
	15.0	8.6	1.98	9.7	2.01	10.3	2.03	11.0	2.05	11.8	2.08	12.1	2.09
	20.0	8.6	1.97	9.7	2.00	10.3	2.02	11.0	2.04	11.8	2.07	12.1	2.08
	25.0	8.6	2.23	9.7	2.27	10.3	2.29	11.0	2.31	11.8	2.34	12.1	2.35
	30.0	8.6	2.68	9.7	2.72	10.3	2.75	11.0	2.78	11.8	2.81	12.1	2.82
	35.0	8.6	3.23	9.7	3.29	10.3	3.31	11.0	3.35	11.8	3.39	12.1	3.41
	40.0	6.4	2.40	7.2	2.45	7.6	2.47	8.2	2.49	8.7	2.52	9.0	2.54
46.0	4.2	1.58	4.7	1.61	5.0	1.62	5.3	1.64	5.7	1.66	5.9	1.67	
48	-10.0	8.6	2.31	9.7	2.36	10.3	2.37	11.0	2.40	11.8	2.43	12.1	2.44
	0.0	8.6	2.08	9.7	2.12	10.3	2.13	11.0	2.16	11.8	2.18	12.1	2.19
	5.0	8.6	1.94	9.7	1.97	10.3	1.99	11.0	2.01	11.8	2.04	12.1	2.05
	10.0	8.6	1.88	9.7	1.91	10.3	1.93	11.0	1.95	11.8	1.97	12.1	1.98
	15.0	8.6	1.98	9.7	2.01	10.3	2.03	11.0	2.05	11.8	2.08	12.1	2.09
	20.0	8.6	1.97	9.7	2.00	10.3	2.02	11.0	2.04	11.8	2.07	12.1	2.08
	25.0	8.6	2.23	9.7	2.27	10.3	2.29	11.0	2.31	11.8	2.34	12.1	2.35
	30.0	8.6	2.68	9.7	2.72	10.3	2.75	11.0	2.78	11.8	2.81	12.1	2.82
	35.0	8.6	3.23	9.7	3.29	10.3	3.31	11.0	3.35	11.8	3.39	12.1	3.41
	40.0	6.4	2.40	7.2	2.45	7.6	2.47	8.2	2.49	8.7	2.52	9.0	2.54
46.0	4.2	1.58	4.7	1.61	5.0	1.62	5.3	1.64	5.7	1.66	5.9	1.67	

OUTDOOR UNIT
AOYG36KBTAs

OUTDOOR UNIT
AOYG36KBTAs

Indoor unit connect- ing capacity	Outdoor temperature	Indoor temperature											
		18.0 °CDB		21.0 °CDB		23.0 °CDB		27.0 °CDB		29.0 °CDB		32.0 °CDB	
		12.0 °CWB		15.0 °CWB		16.0 °CWB		19.0 °CWB		21.0 °CWB		23.0 °CWB	
kBtu/h	°CDB	TC	IP	TC	IP	TC	IP	TC	IP	TC	IP	TC	IP
31	-10.0	8.6	2.31	9.7	2.36	10.3	2.37	11.0	2.40	11.8	2.43	12.1	2.44
	0.0	8.6	2.08	9.7	2.12	10.3	2.13	11.0	2.16	11.8	2.18	12.1	2.19
	5.0	8.6	1.94	9.7	1.97	10.3	1.99	11.0	2.01	11.8	2.04	12.1	2.05
	10.0	8.6	1.88	9.7	1.91	10.3	1.93	11.0	1.95	11.8	1.97	12.1	1.98
	15.0	8.6	1.98	9.7	2.01	10.3	2.03	11.0	2.05	11.8	2.08	12.1	2.09
	20.0	8.6	1.97	9.7	2.00	10.3	2.02	11.0	2.04	11.8	2.07	12.1	2.08
	25.0	8.6	2.23	9.7	2.27	10.3	2.29	11.0	2.31	11.8	2.34	12.1	2.35
	30.0	8.6	2.68	9.7	2.72	10.3	2.75	11.0	2.78	11.8	2.81	12.1	2.82
	35.0	8.6	3.23	9.7	3.29	10.3	3.31	11.0	3.35	11.8	3.39	12.1	3.41
	40.0	6.4	2.40	7.2	2.45	7.6	2.47	8.2	2.49	8.7	2.52	9.0	2.54
46.0	6.4	1.58	7.2	1.61	7.6	1.62	8.2	1.64	8.7	1.66	9.0	1.67	
30	-10.0	8.4	2.24	9.5	2.28	10.0	2.30	10.7	2.32	11.4	2.35	11.8	2.36
	0.0	8.4	2.01	9.5	2.05	10.0	2.06	10.7	2.09	11.4	2.11	11.8	2.12
	5.0	8.4	1.88	9.5	1.91	10.0	1.93	10.7	1.95	11.4	1.97	11.8	1.98
	10.0	8.4	1.82	9.5	1.85	10.0	1.86	10.7	1.89	11.4	1.91	11.8	1.92
	15.0	8.4	1.91	9.5	1.95	10.0	1.96	10.7	1.99	11.4	2.01	11.8	2.02
	20.0	8.4	1.90	9.5	1.94	10.0	1.95	10.7	1.98	11.4	2.00	11.8	2.01
	25.0	8.4	2.15	9.5	2.19	10.0	2.21	10.7	2.23	11.4	2.26	11.8	2.27
	30.0	8.4	2.59	9.5	2.63	10.0	2.66	10.7	2.69	11.4	2.72	11.8	2.73
	35.0	8.4	3.12	9.5	3.18	10.0	3.20	10.7	3.24	11.4	3.28	11.8	3.30
	40.0	6.2	2.33	7.0	2.37	7.4	2.39	7.9	2.41	8.5	2.44	8.8	2.45
46.0	6.2	1.53	7.0	1.56	7.4	1.57	7.9	1.59	8.5	1.60	8.8	1.61	
28	-10.0	7.8	2.06	8.9	2.10	9.3	2.11	10.0	2.14	10.7	2.16	11.0	2.17
	0.0	7.8	1.85	8.9	1.88	9.3	1.90	10.0	1.92	10.7	1.94	11.0	1.95
	5.0	7.8	1.73	8.9	1.76	9.3	1.77	10.0	1.79	10.7	1.81	11.0	1.82
	10.0	7.8	1.67	8.9	1.70	9.3	1.72	10.0	1.74	10.7	1.76	11.0	1.77
	15.0	7.8	1.76	8.9	1.79	9.3	1.81	10.0	1.83	10.7	1.85	11.0	1.86
	20.0	7.8	1.75	8.9	1.78	9.3	1.80	10.0	1.82	10.7	1.84	11.0	1.85
	25.0	7.8	1.98	8.9	2.02	9.3	2.04	10.0	2.06	10.7	2.08	11.0	2.09
	30.0	7.8	2.38	8.9	2.43	9.3	2.45	10.0	2.47	10.7	2.50	11.0	2.52
	35.0	7.8	2.88	8.9	2.93	9.3	2.95	10.0	2.98	10.7	3.02	11.0	3.03
	40.0	5.8	2.14	6.6	2.18	6.9	2.20	7.4	2.22	7.9	2.25	8.2	2.26
46.0	5.8	1.41	6.6	1.43	6.9	1.44	7.4	1.46	7.9	1.48	8.2	1.49	
27	-10.0	7.5	1.96	8.5	1.99	9.0	2.01	9.6	2.03	10.3	2.06	10.6	2.07
	0.0	7.5	1.76	8.5	1.79	9.0	1.81	9.6	1.83	10.3	1.85	10.6	1.86
	5.0	7.5	1.64	8.5	1.67	9.0	1.69	9.6	1.70	10.3	1.72	10.6	1.73
	10.0	7.5	1.59	8.5	1.62	9.0	1.63	9.6	1.65	10.3	1.67	10.6	1.68
	15.0	7.5	1.68	8.5	1.71	9.0	1.72	9.6	1.74	10.3	1.76	10.6	1.77
	20.0	7.5	1.67	8.5	1.70	9.0	1.71	9.6	1.73	10.3	1.75	10.6	1.76
	25.0	7.5	1.89	8.5	1.92	9.0	1.94	9.6	1.96	10.3	1.98	10.6	1.99
	30.0	7.5	2.27	8.5	2.31	9.0	2.33	9.6	2.35	10.3	2.38	10.6	2.39
	35.0	7.5	2.73	8.5	2.78	9.0	2.81	9.6	2.84	10.3	2.87	10.6	2.89
	40.0	5.6	2.04	6.3	2.07	6.7	2.09	7.1	2.11	7.6	2.14	7.9	2.15
46.0	5.6	1.34	6.3	1.36	6.7	1.37	7.1	1.39	7.6	1.40	7.9	1.41	

NOTES:

- TC: Total Capacity (kW), IP: Input Power (kW)
- Values mentioned in the table are based on the following conditions:
 - Power source of specifications: 230 V
 - Pipe length: 5 m, Height difference: 0 m (Outdoor unit—Indoor unit)
- 2 or more indoor units should be connected.
- The total ability of connected indoor unit is from 27,000 Btu/h up to 54,000 Btu/h.
- Input in the table are calculated based on the maximum indoor unit input combinations.

● Compact cassette type

Model: AUXG07KVLA

Outdoor temperature	Indoor temperature (°CDB / °CWB)											
	18.0 / 12.0		21.0 / 15.0		23.0 / 16.0		27.0 / 19.0		29.0 / 21.0		32.0 / 23.0	
(°CDB)	TC	SHC	TC	SHC	TC	SHC	TC	SHC	TC	SHC	TC	SHC
-10.0	1.96	1.32	2.22	1.51	2.34	1.74	2.50	1.95	2.67	2.13	2.76	2.44
0.0	1.96	1.32	2.22	1.51	2.34	1.74	2.50	1.95	2.67	2.13	2.76	2.44
5.0	1.96	1.32	2.22	1.51	2.34	1.74	2.50	1.95	2.67	2.13	2.76	2.44
10.0	1.96	1.32	2.22	1.51	2.34	1.74	2.50	1.95	2.67	2.13	2.76	2.44
15.0	1.96	1.32	2.22	1.51	2.34	1.74	2.50	1.95	2.67	2.13	2.76	2.44
20.0	1.96	1.32	2.22	1.51	2.34	1.74	2.50	1.95	2.67	2.13	2.76	2.44
25.0	1.96	1.32	2.22	1.51	2.34	1.74	2.50	1.95	2.67	2.13	2.76	2.44
30.0	1.96	1.32	2.22	1.51	2.34	1.74	2.50	1.95	2.67	2.13	2.76	2.44
35.0	1.96	1.32	2.22	1.51	2.34	1.74	2.50	1.95	2.67	2.13	2.76	2.44
40.0	1.45	0.72	1.64	0.83	1.73	0.95	1.85	1.07	1.98	1.17	2.04	1.34
46.0	0.94	0.30	1.06	0.35	1.12	0.40	1.20	0.45	1.28	0.49	1.32	0.56

Model: AUXG09KVLA

Outdoor temperature	Indoor temperature (°CDB / °CWB)											
	18.0 / 12.0		21.0 / 15.0		23.0 / 16.0		27.0 / 19.0		29.0 / 21.0		32.0 / 23.0	
(°CDB)	TC	SHC	TC	SHC	TC	SHC	TC	SHC	TC	SHC	TC	SHC
-10.0	2.51	1.67	2.84	1.90	2.99	2.19	3.20	2.46	3.42	2.69	3.53	3.09
0.0	2.51	1.67	2.84	1.90	2.99	2.19	3.20	2.46	3.42	2.69	3.53	3.09
5.0	2.51	1.67	2.84	1.90	2.99	2.19	3.20	2.46	3.42	2.69	3.53	3.09
10.0	2.51	1.67	2.84	1.90	2.99	2.19	3.20	2.46	3.42	2.69	3.53	3.09
15.0	2.51	1.67	2.84	1.90	2.99	2.19	3.20	2.46	3.42	2.69	3.53	3.09
20.0	2.51	1.67	2.84	1.90	2.99	2.19	3.20	2.46	3.42	2.69	3.53	3.09
25.0	2.51	1.67	2.84	1.90	2.99	2.19	3.20	2.46	3.42	2.69	3.53	3.09
30.0	2.51	1.67	2.84	1.90	2.99	2.19	3.20	2.46	3.42	2.69	3.53	3.09
35.0	2.51	1.67	2.84	1.90	2.99	2.19	3.20	2.46	3.42	2.69	3.53	3.09
40.0	1.86	0.92	2.10	1.04	2.21	1.20	2.37	1.35	2.53	1.48	2.61	1.69
46.0	1.20	0.38	1.36	0.44	1.43	0.51	1.54	0.57	1.64	0.62	1.69	0.71

Model: AUXG12KVLA

Outdoor temperature	Indoor temperature (°CDB / °CWB)											
	18.0 / 12.0		21.0 / 15.0		23.0 / 16.0		27.0 / 19.0		29.0 / 21.0		32.0 / 23.0	
(°CDB)	TC	SHC	TC	SHC	TC	SHC	TC	SHC	TC	SHC	TC	SHC
-10.0	3.37	2.22	3.81	2.53	4.02	2.91	4.30	3.27	4.60	3.57	4.74	4.10
0.0	3.37	2.22	3.81	2.53	4.02	2.91	4.30	3.27	4.60	3.57	4.74	4.10
5.0	3.37	2.22	3.81	2.53	4.02	2.91	4.30	3.27	4.60	3.57	4.74	4.10
10.0	3.37	2.22	3.81	2.53	4.02	2.91	4.30	3.27	4.60	3.57	4.74	4.10
15.0	3.37	2.22	3.81	2.53	4.02	2.91	4.30	3.27	4.60	3.57	4.74	4.10
20.0	3.37	2.22	3.81	2.53	4.02	2.91	4.30	3.27	4.60	3.57	4.74	4.10
25.0	3.37	2.22	3.81	2.53	4.02	2.91	4.30	3.27	4.60	3.57	4.74	4.10
30.0	3.37	2.22	3.81	2.53	4.02	2.91	4.30	3.27	4.60	3.57	4.74	4.10
35.0	3.37	2.22	3.81	2.53	4.02	2.91	4.30	3.27	4.60	3.57	4.74	4.10
40.0	2.49	1.21	2.82	1.38	2.97	1.59	3.18	1.79	3.40	1.96	3.51	2.24
46.0	1.62	0.51	1.83	0.58	1.93	0.67	2.06	0.75	2.21	0.82	2.27	0.94

Model: AUXG14KVLA

Outdoor temperature	Indoor temperature (°CDB / °CWB)											
	18.0 / 12.0		21.0 / 15.0		23.0 / 16.0		27.0 / 19.0		29.0 / 21.0		32.0 / 23.0	
(°CDB)	TC	SHC	TC	SHC	TC	SHC	TC	SHC	TC	SHC	TC	SHC
-10.0	3.92	2.44	4.43	2.78	4.67	3.20	5.00	3.60	5.35	3.94	5.51	4.51
0.0	3.92	2.44	4.43	2.78	4.67	3.20	5.00	3.60	5.35	3.94	5.51	4.51
5.0	3.92	2.44	4.43	2.78	4.67	3.20	5.00	3.60	5.35	3.94	5.51	4.51
10.0	3.92	2.44	4.43	2.78	4.67	3.20	5.00	3.60	5.35	3.94	5.51	4.51
15.0	3.92	2.44	4.43	2.78	4.67	3.20	5.00	3.60	5.35	3.94	5.51	4.51
20.0	3.92	2.44	4.43	2.78	4.67	3.20	5.00	3.60	5.35	3.94	5.51	4.51
25.0	3.92	2.44	4.43	2.78	4.67	3.20	5.00	3.60	5.35	3.94	5.51	4.51
30.0	3.92	2.44	4.43	2.78	4.67	3.20	5.00	3.60	5.35	3.94	5.51	4.51
35.0	3.92	2.44	4.43	2.78	4.67	3.20	5.00	3.60	5.35	3.94	5.51	4.51
40.0	2.90	1.34	3.28	1.52	3.46	1.75	3.70	1.97	3.96	2.16	4.08	2.47
46.0	1.88	0.56	2.13	0.64	2.24	0.74	2.40	0.83	2.57	0.91	2.64	1.04

Model: AUXG18KVLA

Outdoor temperature	Indoor temperature (°CDB / °CWB)											
	18.0 / 12.0		21.0 / 15.0		23.0 / 16.0		27.0 / 19.0		29.0 / 21.0		32.0 / 23.0	
(°CDB)	TC	SHC	TC	SHC	TC	SHC	TC	SHC	TC	SHC	TC	SHC
-10.0	4.85	2.94	5.48	3.35	5.78	3.86	6.19	4.33	6.62	4.74	6.82	5.43
0.0	4.85	2.94	5.48	3.35	5.78	3.86	6.19	4.33	6.62	4.74	6.82	5.43
5.0	4.85	2.94	5.48	3.35	5.78	3.86	6.19	4.33	6.62	4.74	6.82	5.43
10.0	4.85	2.94	5.48	3.35	5.78	3.86	6.19	4.33	6.62	4.74	6.82	5.43
15.0	4.85	2.94	5.48	3.35	5.78	3.86	6.19	4.33	6.62	4.74	6.82	5.43
20.0	4.85	2.94	5.48	3.35	5.78	3.86	6.19	4.33	6.62	4.74	6.82	5.43
25.0	4.85	2.94	5.48	3.35	5.78	3.86	6.19	4.33	6.62	4.74	6.82	5.43
30.0	4.85	2.94	5.48	3.35	5.78	3.86	6.19	4.33	6.62	4.74	6.82	5.43
35.0	4.85	2.94	5.48	3.35	5.78	3.86	6.19	4.33	6.62	4.74	6.82	5.43
40.0	3.59	1.61	4.06	1.83	4.28	2.11	4.58	2.37	4.90	2.60	5.05	2.97
46.0	2.33	0.68	2.63	0.77	2.78	0.89	2.97	1.00	3.18	1.09	3.27	1.25

Model: AUXG22KVLA

Outdoor temperature	Indoor temperature (°CDB / °CWB)											
	18.0 / 12.0		21.0 / 15.0		23.0 / 16.0		27.0 / 19.0		29.0 / 21.0		32.0 / 23.0	
(°CDB)	TC	SHC	TC	SHC	TC	SHC	TC	SHC	TC	SHC	TC	SHC
-10.0	6.12	3.70	6.91	4.22	7.29	4.86	7.80	5.46	8.34	5.97	8.60	6.84
0.0	6.12	3.70	6.91	4.22	7.29	4.86	7.80	5.46	8.34	5.97	8.60	6.84
5.0	6.12	3.70	6.91	4.22	7.29	4.86	7.80	5.46	8.34	5.97	8.60	6.84
10.0	6.12	3.70	6.91	4.22	7.29	4.86	7.80	5.46	8.34	5.97	8.60	6.84
15.0	6.12	3.70	6.91	4.22	7.29	4.86	7.80	5.46	8.34	5.97	8.60	6.84
20.0	6.12	3.70	6.91	4.22	7.29	4.86	7.80	5.46	8.34	5.97	8.60	6.84
25.0	6.12	3.70	6.91	4.22	7.29	4.86	7.80	5.46	8.34	5.97	8.60	6.84
30.0	6.12	3.70	6.91	4.22	7.29	4.86	7.80	5.46	8.34	5.97	8.60	6.84
35.0	6.12	3.70	6.91	4.22	7.29	4.86	7.80	5.46	8.34	5.97	8.60	6.84
40.0	4.53	2.03	5.11	2.31	5.39	2.66	5.77	2.99	6.17	3.27	6.36	3.75
46.0	2.94	0.85	3.32	0.97	3.50	1.12	3.74	1.26	4.00	1.38	4.13	1.58

NOTES:

- TC: Total Capacity (kW), SHC: Sensible Heat Capacity (kW)
- Values mentioned in the table are based on the following conditions:
 - Pipe length: 5 m, Height difference: 0 m (Outdoor unit—Indoor unit)

● Mini duct type

Model: ARXG07KSLAP

Outdoor temperature	Indoor temperature (°CDB / °CWB)											
	18.0 / 12.0		21.0 / 15.0		23.0 / 16.0		27.0 / 19.0		29.0 / 21.0		32.0 / 23.0	
(°CDB)	TC	SHC	TC	SHC	TC	SHC	TC	SHC	TC	SHC	TC	SHC
-10.0	1.96	1.36	2.22	1.55	2.34	1.78	2.50	2.00	2.67	2.19	2.76	2.51
-5.0	1.96	1.36	2.22	1.55	2.34	1.78	2.50	2.00	2.67	2.19	2.76	2.51
0.0	1.96	1.36	2.22	1.55	2.34	1.78	2.50	2.00	2.67	2.19	2.76	2.51
5.0	1.96	1.36	2.22	1.55	2.34	1.78	2.50	2.00	2.67	2.19	2.76	2.51
10.0	1.96	1.36	2.22	1.55	2.34	1.78	2.50	2.00	2.67	2.19	2.76	2.51
15.0	1.96	1.36	2.22	1.55	2.34	1.78	2.50	2.00	2.67	2.19	2.76	2.51
20.0	1.96	1.36	2.22	1.55	2.34	1.78	2.50	2.00	2.67	2.19	2.76	2.51
25.0	1.96	1.36	2.22	1.55	2.34	1.78	2.50	2.00	2.67	2.19	2.76	2.51
30.0	1.96	1.36	2.22	1.55	2.34	1.78	2.50	2.00	2.67	2.19	2.76	2.51
35.0	1.96	1.36	2.22	1.55	2.34	1.78	2.50	2.00	2.67	2.19	2.76	2.51
40.0	1.45	0.74	1.64	0.85	1.73	0.97	1.85	1.10	1.98	1.20	2.04	1.37
46.0	0.94	0.31	1.06	0.36	1.12	0.41	1.20	0.46	1.28	0.50	1.32	0.58

Model: ARXG09KSLAP

Outdoor temperature	Indoor temperature (°CDB / °CWB)											
	18.0 / 12.0		21.0 / 15.0		23.0 / 16.0		27.0 / 19.0		29.0 / 21.0		32.0 / 23.0	
(°CDB)	TC	SHC	TC	SHC	TC	SHC	TC	SHC	TC	SHC	TC	SHC
-10.0	2.51	1.61	2.84	1.83	2.99	2.11	3.20	2.37	3.42	2.59	3.53	2.97
-5.0	2.51	1.61	2.84	1.83	2.99	2.11	3.20	2.37	3.42	2.59	3.53	2.97
0.0	2.51	1.61	2.84	1.83	2.99	2.11	3.20	2.37	3.42	2.59	3.53	2.97
5.0	2.51	1.61	2.84	1.83	2.99	2.11	3.20	2.37	3.42	2.59	3.53	2.97
10.0	2.51	1.61	2.84	1.83	2.99	2.11	3.20	2.37	3.42	2.59	3.53	2.97
15.0	2.51	1.61	2.84	1.83	2.99	2.11	3.20	2.37	3.42	2.59	3.53	2.97
20.0	2.51	1.61	2.84	1.83	2.99	2.11	3.20	2.37	3.42	2.59	3.53	2.97
25.0	2.51	1.61	2.84	1.83	2.99	2.11	3.20	2.37	3.42	2.59	3.53	2.97
30.0	2.51	1.61	2.84	1.83	2.99	2.11	3.20	2.37	3.42	2.59	3.53	2.97
35.0	2.51	1.61	2.84	1.83	2.99	2.11	3.20	2.37	3.42	2.59	3.53	2.97
40.0	1.86	0.88	2.10	1.00	2.21	1.15	2.37	1.30	2.53	1.42	2.61	1.62
46.0	1.20	0.37	1.36	0.42	1.43	0.49	1.54	0.55	1.64	0.60	1.69	0.68

Model: ARXG12KSLAP

Outdoor temperature	Indoor temperature (°CDB / °CWB)											
	18.0 / 12.0		21.0 / 15.0		23.0 / 16.0		27.0 / 19.0		29.0 / 21.0		32.0 / 23.0	
(°CDB)	TC	SHC	TC	SHC	TC	SHC	TC	SHC	TC	SHC	TC	SHC
-10.0	3.37	2.16	3.81	2.46	4.02	2.83	4.30	3.18	4.60	3.48	4.74	3.99
-5.0	3.37	2.16	3.81	2.46	4.02	2.83	4.30	3.18	4.60	3.48	4.74	3.99
0.0	3.37	2.16	3.81	2.46	4.02	2.83	4.30	3.18	4.60	3.48	4.74	3.99
5.0	3.37	2.16	3.81	2.46	4.02	2.83	4.30	3.18	4.60	3.48	4.74	3.99
10.0	3.37	2.16	3.81	2.46	4.02	2.83	4.30	3.18	4.60	3.48	4.74	3.99
15.0	3.37	2.16	3.81	2.46	4.02	2.83	4.30	3.18	4.60	3.48	4.74	3.99
20.0	3.37	2.16	3.81	2.46	4.02	2.83	4.30	3.18	4.60	3.48	4.74	3.99
25.0	3.37	2.16	3.81	2.46	4.02	2.83	4.30	3.18	4.60	3.48	4.74	3.99
30.0	3.37	2.16	3.81	2.46	4.02	2.83	4.30	3.18	4.60	3.48	4.74	3.99
35.0	3.37	2.16	3.81	2.46	4.02	2.83	4.30	3.18	4.60	3.48	4.74	3.99
40.0	2.49	1.18	2.82	1.35	2.97	1.55	3.18	1.74	3.40	1.91	3.51	2.18
46.0	1.62	0.50	1.83	0.57	1.93	0.65	2.06	0.73	2.21	0.80	2.27	0.92

Model: ARXG14KSLAP

Outdoor temperature	Indoor temperature (°CDB / °CWB)											
	18.0 / 12.0		21.0 / 15.0		23.0 / 16.0		27.0 / 19.0		29.0 / 21.0		32.0 / 23.0	
(°CDB)	TC	SHC	TC	SHC	TC	SHC	TC	SHC	TC	SHC	TC	SHC
-10.0	3.92	2.41	4.43	2.74	4.67	3.16	5.00	3.55	5.35	3.88	5.51	4.45
-5.0	3.92	2.41	4.43	2.74	4.67	3.16	5.00	3.55	5.35	3.88	5.51	4.45
0.0	3.92	2.41	4.43	2.74	4.67	3.16	5.00	3.55	5.35	3.88	5.51	4.45
5.0	3.92	2.41	4.43	2.74	4.67	3.16	5.00	3.55	5.35	3.88	5.51	4.45
10.0	3.92	2.41	4.43	2.74	4.67	3.16	5.00	3.55	5.35	3.88	5.51	4.45
15.0	3.92	2.41	4.43	2.74	4.67	3.16	5.00	3.55	5.35	3.88	5.51	4.45
20.0	3.92	2.41	4.43	2.74	4.67	3.16	5.00	3.55	5.35	3.88	5.51	4.45
25.0	3.92	2.41	4.43	2.74	4.67	3.16	5.00	3.55	5.35	3.88	5.51	4.45
30.0	3.92	2.41	4.43	2.74	4.67	3.16	5.00	3.55	5.35	3.88	5.51	4.45
35.0	3.92	2.41	4.43	2.74	4.67	3.16	5.00	3.55	5.35	3.88	5.51	4.45
40.0	2.90	1.32	3.28	1.50	3.46	1.73	3.70	1.94	3.96	2.13	4.08	2.44
46.0	1.88	0.55	2.13	0.63	2.24	0.73	2.40	0.82	2.57	0.89	2.64	1.02

Model: ARXG18KSLAP

Outdoor temperature (°CDB)	Indoor temperature (°CDB / °CWB)											
	18.0 / 12.0		21.0 / 15.0		23.0 / 16.0		27.0 / 19.0		29.0 / 21.0		32.0 / 23.0	
	TC	SHC	TC	SHC	TC	SHC	TC	SHC	TC	SHC	TC	SHC
-10.0	4.85	3.02	5.48	3.45	5.78	3.97	6.19	4.46	6.62	4.87	6.82	5.58
-5.0	4.85	3.02	5.48	3.45	5.78	3.97	6.19	4.46	6.62	4.87	6.82	5.58
0.0	4.85	3.02	5.48	3.45	5.78	3.97	6.19	4.46	6.62	4.87	6.82	5.58
5.0	4.85	3.02	5.48	3.45	5.78	3.97	6.19	4.46	6.62	4.87	6.82	5.58
10.0	4.85	3.02	5.48	3.45	5.78	3.97	6.19	4.46	6.62	4.87	6.82	5.58
15.0	4.85	3.02	5.48	3.45	5.78	3.97	6.19	4.46	6.62	4.87	6.82	5.58
20.0	4.85	3.02	5.48	3.45	5.78	3.97	6.19	4.46	6.62	4.87	6.82	5.58
25.0	4.85	3.02	5.48	3.45	5.78	3.97	6.19	4.46	6.62	4.87	6.82	5.58
30.0	4.85	3.02	5.48	3.45	5.78	3.97	6.19	4.46	6.62	4.87	6.82	5.58
35.0	4.85	3.02	5.48	3.45	5.78	3.97	6.19	4.46	6.62	4.87	6.82	5.58
40.0	3.59	1.66	4.06	1.89	4.28	2.17	4.58	2.44	4.90	2.67	5.05	3.06
46.0	2.33	0.70	2.63	0.79	2.78	0.91	2.97	1.03	3.18	1.12	3.27	1.29

NOTES:

- TC: Total Capacity (kW), SHC: Sensible Heat Capacity (kW)
- Values mentioned in the table are based on the following conditions:
 - Pipe length: 5 m, Height difference: 0 m [Outdoor unit—Indoor unit]

● Slim duct type

Model: ARXG07KLLAP

Outdoor temperature	Indoor temperature (°CDB / °CWB)											
	18.0 / 12.0		21.0 / 15.0		23.0 / 16.0		27.0 / 19.0		29.0 / 21.0		32.0 / 23.0	
(°CDB)	TC	SHC	TC	SHC	TC	SHC	TC	SHC	TC	SHC	TC	SHC
-10.0	1.96	1.36	2.22	1.55	2.34	1.78	2.50	2.00	2.67	2.19	2.76	2.51
-5.0	1.96	1.36	2.22	1.55	2.34	1.78	2.50	2.00	2.67	2.19	2.76	2.51
0.0	1.96	1.36	2.22	1.55	2.34	1.78	2.50	2.00	2.67	2.19	2.76	2.51
5.0	1.96	1.36	2.22	1.55	2.34	1.78	2.50	2.00	2.67	2.19	2.76	2.51
10.0	1.96	1.36	2.22	1.55	2.34	1.78	2.50	2.00	2.67	2.19	2.76	2.51
15.0	1.96	1.36	2.22	1.55	2.34	1.78	2.50	2.00	2.67	2.19	2.76	2.51
20.0	1.96	1.36	2.22	1.55	2.34	1.78	2.50	2.00	2.67	2.19	2.76	2.51
25.0	1.96	1.36	2.22	1.55	2.34	1.78	2.50	2.00	2.67	2.19	2.76	2.51
30.0	1.96	1.36	2.22	1.55	2.34	1.78	2.50	2.00	2.67	2.19	2.76	2.51
35.0	1.96	1.36	2.22	1.55	2.34	1.78	2.50	2.00	2.67	2.19	2.76	2.51
40.0	1.45	0.74	1.64	0.85	1.73	0.97	1.85	1.10	1.98	1.20	2.04	1.37
46.0	0.94	0.31	1.06	0.36	1.12	0.41	1.20	0.46	1.28	0.50	1.32	0.58

Model: ARXG09KLLAP

Outdoor temperature	Indoor temperature (°CDB / °CWB)											
	18.0 / 12.0		21.0 / 15.0		23.0 / 16.0		27.0 / 19.0		29.0 / 21.0		32.0 / 23.0	
(°CDB)	TC	SHC	TC	SHC	TC	SHC	TC	SHC	TC	SHC	TC	SHC
-10.0	2.51	1.67	2.84	1.90	2.99	2.19	3.20	2.46	3.42	2.69	3.53	3.09
-5.0	2.51	1.67	2.84	1.90	2.99	2.19	3.20	2.46	3.42	2.69	3.53	3.09
0.0	2.51	1.67	2.84	1.90	2.99	2.19	3.20	2.46	3.42	2.69	3.53	3.09
5.0	2.51	1.67	2.84	1.90	2.99	2.19	3.20	2.46	3.42	2.69	3.53	3.09
10.0	2.51	1.67	2.84	1.90	2.99	2.19	3.20	2.46	3.42	2.69	3.53	3.09
15.0	2.51	1.67	2.84	1.90	2.99	2.19	3.20	2.46	3.42	2.69	3.53	3.09
20.0	2.51	1.67	2.84	1.90	2.99	2.19	3.20	2.46	3.42	2.69	3.53	3.09
25.0	2.51	1.67	2.84	1.90	2.99	2.19	3.20	2.46	3.42	2.69	3.53	3.09
30.0	2.51	1.67	2.84	1.90	2.99	2.19	3.20	2.46	3.42	2.69	3.53	3.09
35.0	2.51	1.67	2.84	1.90	2.99	2.19	3.20	2.46	3.42	2.69	3.53	3.09
40.0	1.86	0.92	2.10	1.04	2.21	1.20	2.37	1.35	2.53	1.48	2.61	1.69
46.0	1.20	0.38	1.36	0.44	1.43	0.51	1.54	0.57	1.64	0.62	1.69	0.71

Model: ARXG12KLLAP

Outdoor temperature	Indoor temperature (°CDB / °CWB)											
	18.0 / 12.0		21.0 / 15.0		23.0 / 16.0		27.0 / 19.0		29.0 / 21.0		32.0 / 23.0	
(°CDB)	TC	SHC	TC	SHC	TC	SHC	TC	SHC	TC	SHC	TC	SHC
-10.0	3.37	2.27	3.81	2.59	4.02	2.99	4.30	3.35	4.60	3.67	4.74	4.20
-5.0	3.37	2.27	3.81	2.59	4.02	2.99	4.30	3.35	4.60	3.67	4.74	4.20
0.0	3.37	2.27	3.81	2.59	4.02	2.99	4.30	3.35	4.60	3.67	4.74	4.20
5.0	3.37	2.27	3.81	2.59	4.02	2.99	4.30	3.35	4.60	3.67	4.74	4.20
10.0	3.37	2.27	3.81	2.59	4.02	2.99	4.30	3.35	4.60	3.67	4.74	4.20
15.0	3.37	2.27	3.81	2.59	4.02	2.99	4.30	3.35	4.60	3.67	4.74	4.20
20.0	3.37	2.27	3.81	2.59	4.02	2.99	4.30	3.35	4.60	3.67	4.74	4.20
25.0	3.37	2.27	3.81	2.59	4.02	2.99	4.30	3.35	4.60	3.67	4.74	4.20
30.0	3.37	2.27	3.81	2.59	4.02	2.99	4.30	3.35	4.60	3.67	4.74	4.20
35.0	3.37	2.27	3.81	2.59	4.02	2.99	4.30	3.35	4.60	3.67	4.74	4.20
40.0	2.49	1.25	2.82	1.42	2.97	1.63	3.18	1.84	3.40	2.01	3.51	2.30
46.0	1.62	0.52	1.83	0.60	1.93	0.69	2.06	0.77	2.21	0.85	2.27	0.97

Model: ARXG14KLLAP

Outdoor temperature	Indoor temperature (°CDB / °CWB)											
	18.0 / 12.0		21.0 / 15.0		23.0 / 16.0		27.0 / 19.0		29.0 / 21.0		32.0 / 23.0	
(°CDB)	TC	SHC	TC	SHC	TC	SHC	TC	SHC	TC	SHC	TC	SHC
-10.0	3.92	2.51	4.43	2.86	4.67	3.29	5.00	3.70	5.35	4.05	5.51	4.64
-5.0	3.92	2.51	4.43	2.86	4.67	3.29	5.00	3.70	5.35	4.05	5.51	4.64
0.0	3.92	2.51	4.43	2.86	4.67	3.29	5.00	3.70	5.35	4.05	5.51	4.64
5.0	3.92	2.51	4.43	2.86	4.67	3.29	5.00	3.70	5.35	4.05	5.51	4.64
10.0	3.92	2.51	4.43	2.86	4.67	3.29	5.00	3.70	5.35	4.05	5.51	4.64
15.0	3.92	2.51	4.43	2.86	4.67	3.29	5.00	3.70	5.35	4.05	5.51	4.64
20.0	3.92	2.51	4.43	2.86	4.67	3.29	5.00	3.70	5.35	4.05	5.51	4.64
25.0	3.92	2.51	4.43	2.86	4.67	3.29	5.00	3.70	5.35	4.05	5.51	4.64
30.0	3.92	2.51	4.43	2.86	4.67	3.29	5.00	3.70	5.35	4.05	5.51	4.64
35.0	3.92	2.51	4.43	2.86	4.67	3.29	5.00	3.70	5.35	4.05	5.51	4.64
40.0	2.90	1.37	3.28	1.57	3.46	1.80	3.70	2.03	3.96	2.22	4.08	2.54
46.0	1.88	0.58	2.13	0.66	2.24	0.76	2.40	0.85	2.57	0.93	2.64	1.07

Model: ARXG18KLLAP

Outdoor temperature	Indoor temperature (°CDB / °CWB)											
	18.0 / 12.0		21.0 / 15.0		23.0 / 16.0		27.0 / 19.0		29.0 / 21.0		32.0 / 23.0	
(°CDB)	TC	SHC	TC	SHC	TC	SHC	TC	SHC	TC	SHC	TC	SHC
-10.0	4.80	2.99	5.42	3.41	5.72	3.92	6.12	4.41	6.54	4.82	6.74	5.52
-5.0	4.80	2.99	5.42	3.41	5.72	3.92	6.12	4.41	6.54	4.82	6.74	5.52
0.0	4.80	2.99	5.42	3.41	5.72	3.92	6.12	4.41	6.54	4.82	6.74	5.52
5.0	4.80	2.99	5.42	3.41	5.72	3.92	6.12	4.41	6.54	4.82	6.74	5.52
10.0	4.80	2.99	5.42	3.41	5.72	3.92	6.12	4.41	6.54	4.82	6.74	5.52
15.0	4.80	2.99	5.42	3.41	5.72	3.92	6.12	4.41	6.54	4.82	6.74	5.52
20.0	4.80	2.99	5.42	3.41	5.72	3.92	6.12	4.41	6.54	4.82	6.74	5.52
25.0	4.80	2.99	5.42	3.41	5.72	3.92	6.12	4.41	6.54	4.82	6.74	5.52
30.0	4.80	2.99	5.42	3.41	5.72	3.92	6.12	4.41	6.54	4.82	6.74	5.52
35.0	4.80	2.99	5.42	3.41	5.72	3.92	6.12	4.41	6.54	4.82	6.74	5.52
40.0	3.55	1.64	4.01	1.87	4.23	2.15	4.53	2.41	4.84	2.64	4.99	3.02
46.0	2.30	0.69	2.60	0.78	2.74	0.90	2.94	1.02	3.14	1.11	3.24	1.27

NOTES:

- TC: Total Capacity (kW), SHC: Sensible Heat Capacity (kW)
- Values mentioned in the table are based on the following conditions:
 - Pipe length: 5 m, Height difference: 0 m (Outdoor unit—Indoor unit)

● Medium static pressure duct type

Model: ARXG22KMLB

Outdoor temperature	Indoor temperature (°CDB / °CWB)											
	18.0 / 12.0		21.0 / 15.0		23.0 / 16.0		27.0 / 19.0		29.0 / 21.0		32.0 / 23.0	
(°CDB)	TC	SHC	TC	SHC	TC	SHC	TC	SHC	TC	SHC	TC	SHC
-10.0	6.12	4.03	6.91	4.59	7.29	5.29	7.80	5.94	8.34	6.50	8.60	7.44
-5.0	6.12	4.03	6.91	4.59	7.29	5.29	7.80	5.94	8.34	6.50	8.60	7.44
0.0	6.12	4.03	6.91	4.59	7.29	5.29	7.80	5.94	8.34	6.50	8.60	7.44
5.0	6.12	4.03	6.91	4.59	7.29	5.29	7.80	5.94	8.34	6.50	8.60	7.44
10.0	6.12	4.03	6.91	4.59	7.29	5.29	7.80	5.94	8.34	6.50	8.60	7.44
15.0	6.12	4.03	6.91	4.59	7.29	5.29	7.80	5.94	8.34	6.50	8.60	7.44
20.0	6.12	4.03	6.91	4.59	7.29	5.29	7.80	5.94	8.34	6.50	8.60	7.44
25.0	6.12	4.03	6.91	4.59	7.29	5.29	7.80	5.94	8.34	6.50	8.60	7.44
30.0	6.12	4.03	6.91	4.59	7.29	5.29	7.80	5.94	8.34	6.50	8.60	7.44
35.0	6.12	4.03	6.91	4.59	7.29	5.29	7.80	5.94	8.34	6.50	8.60	7.44
40.0	4.53	2.21	5.11	2.52	5.39	2.90	5.77	3.25	6.17	3.56	6.36	4.08
46.0	2.94	0.93	3.32	1.06	3.50	1.22	3.74	1.37	4.00	1.50	4.13	1.72

NOTES:

- TC: Total Capacity (kW), SHC: Sensible Heat Capacity (kW).
- Values mentioned in the table are based on the following conditions:
 - Pipe length: 5 m, Height difference: 0 m (Outdoor unit—Indoor unit)

● Wall mounted type

Model: ASYG07KGTB

Outdoor temperature	Indoor temperature (°CDB / °CWB)											
	18.0 / 12.0		21.0 / 15.0		23.0 / 16.0		27.0 / 19.0		29.0 / 21.0		32.0 / 23.0	
(°CDB)	TC	SHC	TC	SHC	TC	SHC	TC	SHC	TC	SHC	TC	SHC
-10.0	1.96	1.10	2.22	1.26	2.34	1.45	2.50	1.63	2.67	1.78	2.76	2.04
-5.0	1.96	1.10	2.22	1.26	2.34	1.45	2.50	1.63	2.67	1.78	2.76	2.04
0.0	1.96	1.10	2.22	1.26	2.34	1.45	2.50	1.63	2.67	1.78	2.76	2.04
5.0	1.96	1.10	2.22	1.26	2.34	1.45	2.50	1.63	2.67	1.78	2.76	2.04
10.0	1.96	1.10	2.22	1.26	2.34	1.45	2.50	1.63	2.67	1.78	2.76	2.04
15.0	1.96	1.10	2.22	1.26	2.34	1.45	2.50	1.63	2.67	1.78	2.76	2.04
20.0	1.96	1.10	2.22	1.26	2.34	1.45	2.50	1.63	2.67	1.78	2.76	2.04
25.0	1.96	1.10	2.22	1.26	2.34	1.45	2.50	1.63	2.67	1.78	2.76	2.04
30.0	1.96	1.10	2.22	1.26	2.34	1.45	2.50	1.63	2.67	1.78	2.76	2.04
35.0	1.96	1.10	2.22	1.26	2.34	1.45	2.50	1.63	2.67	1.78	2.76	2.04
40.0	1.45	0.60	1.64	0.69	1.73	0.79	1.85	0.89	1.98	0.97	2.04	1.12
46.0	0.94	0.25	1.06	0.29	1.12	0.33	1.20	0.37	1.28	0.41	1.32	0.47

Model: ASYG09KGTB

Outdoor temperature	Indoor temperature (°CDB / °CWB)											
	18.0 / 12.0		21.0 / 15.0		23.0 / 16.0		27.0 / 19.0		29.0 / 21.0		32.0 / 23.0	
(°CDB)	TC	SHC	TC	SHC	TC	SHC	TC	SHC	TC	SHC	TC	SHC
-10.0	2.51	1.41	2.84	1.61	2.99	1.85	3.20	2.08	3.42	2.27	3.53	2.61
-5.0	2.51	1.41	2.84	1.61	2.99	1.85	3.20	2.08	3.42	2.27	3.53	2.61
0.0	2.51	1.41	2.84	1.61	2.99	1.85	3.20	2.08	3.42	2.27	3.53	2.61
5.0	2.51	1.41	2.84	1.61	2.99	1.85	3.20	2.08	3.42	2.27	3.53	2.61
10.0	2.51	1.41	2.84	1.61	2.99	1.85	3.20	2.08	3.42	2.27	3.53	2.61
15.0	2.51	1.41	2.84	1.61	2.99	1.85	3.20	2.08	3.42	2.27	3.53	2.61
20.0	2.51	1.41	2.84	1.61	2.99	1.85	3.20	2.08	3.42	2.27	3.53	2.61
25.0	2.51	1.41	2.84	1.61	2.99	1.85	3.20	2.08	3.42	2.27	3.53	2.61
30.0	2.51	1.41	2.84	1.61	2.99	1.85	3.20	2.08	3.42	2.27	3.53	2.61
35.0	2.51	1.41	2.84	1.61	2.99	1.85	3.20	2.08	3.42	2.27	3.53	2.61
40.0	1.86	0.77	2.10	0.88	2.21	1.01	2.37	1.14	2.53	1.25	2.61	1.43
46.0	1.20	0.32	1.36	0.37	1.43	0.43	1.54	0.48	1.64	0.52	1.69	0.60

Model: ASYG12KGTB

Outdoor temperature	Indoor temperature (°CDB / °CWB)											
	18.0 / 12.0		21.0 / 15.0		23.0 / 16.0		27.0 / 19.0		29.0 / 21.0		32.0 / 23.0	
(°CDB)	TC	SHC	TC	SHC	TC	SHC	TC	SHC	TC	SHC	TC	SHC
-10.0	3.37	1.90	3.81	2.16	4.02	2.49	4.30	2.80	4.60	3.06	4.74	3.50
-5.0	3.37	1.90	3.81	2.16	4.02	2.49	4.30	2.80	4.60	3.06	4.74	3.50
0.0	3.37	1.90	3.81	2.16	4.02	2.49	4.30	2.80	4.60	3.06	4.74	3.50
5.0	3.37	1.90	3.81	2.16	4.02	2.49	4.30	2.80	4.60	3.06	4.74	3.50
10.0	3.37	1.90	3.81	2.16	4.02	2.49	4.30	2.80	4.60	3.06	4.74	3.50
15.0	3.37	1.90	3.81	2.16	4.02	2.49	4.30	2.80	4.60	3.06	4.74	3.50
20.0	3.37	1.90	3.81	2.16	4.02	2.49	4.30	2.80	4.60	3.06	4.74	3.50
25.0	3.37	1.90	3.81	2.16	4.02	2.49	4.30	2.80	4.60	3.06	4.74	3.50
30.0	3.37	1.90	3.81	2.16	4.02	2.49	4.30	2.80	4.60	3.06	4.74	3.50
35.0	3.37	1.90	3.81	2.16	4.02	2.49	4.30	2.80	4.60	3.06	4.74	3.50
40.0	2.49	1.04	2.82	1.18	2.97	1.36	3.18	1.53	3.40	1.67	3.51	1.92
46.0	1.62	0.44	1.83	0.50	1.93	0.57	2.06	0.64	2.21	0.70	2.27	0.81

Model: ASYG14KGTB

Outdoor temperature	Indoor temperature (°CDB / °CWB)											
	18.0 / 12.0		21.0 / 15.0		23.0 / 16.0		27.0 / 19.0		29.0 / 21.0		32.0 / 23.0	
(°CDB)	TC	SHC	TC	SHC	TC	SHC	TC	SHC	TC	SHC	TC	SHC
-10.0	3.92	2.20	4.43	2.51	4.67	2.89	5.00	3.25	5.35	3.55	5.51	4.07
-5.0	3.92	2.20	4.43	2.51	4.67	2.89	5.00	3.25	5.35	3.55	5.51	4.07
0.0	3.92	2.20	4.43	2.51	4.67	2.89	5.00	3.25	5.35	3.55	5.51	4.07
5.0	3.92	2.20	4.43	2.51	4.67	2.89	5.00	3.25	5.35	3.55	5.51	4.07
10.0	3.92	2.20	4.43	2.51	4.67	2.89	5.00	3.25	5.35	3.55	5.51	4.07
15.0	3.92	2.20	4.43	2.51	4.67	2.89	5.00	3.25	5.35	3.55	5.51	4.07
20.0	3.92	2.20	4.43	2.51	4.67	2.89	5.00	3.25	5.35	3.55	5.51	4.07
25.0	3.92	2.20	4.43	2.51	4.67	2.89	5.00	3.25	5.35	3.55	5.51	4.07
30.0	3.92	2.20	4.43	2.51	4.67	2.89	5.00	3.25	5.35	3.55	5.51	4.07
35.0	3.92	2.20	4.43	2.51	4.67	2.89	5.00	3.25	5.35	3.55	5.51	4.07
40.0	2.90	1.21	3.28	1.38	3.46	1.58	3.70	1.78	3.96	1.95	4.08	2.23
46.0	1.88	0.51	2.13	0.58	2.24	0.67	2.40	0.75	2.57	0.82	2.64	0.94

Model: ASYG18KMTB

Outdoor temperature	Indoor temperature (°CDB / °CWB)											
	18.0 / 12.0		21.0 / 15.0		23.0 / 16.0		27.0 / 19.0		29.0 / 21.0		32.0 / 23.0	
(°CDB)	TC	SHC	TC	SHC	TC	SHC	TC	SHC	TC	SHC	TC	SHC
-10.0	4.85	3.27	5.48	3.73	5.78	4.30	6.19	4.83	6.62	5.28	6.82	6.05
-5.0	4.85	3.27	5.48	3.73	5.78	4.30	6.19	4.83	6.62	5.28	6.82	6.05
0.0	4.85	3.27	5.48	3.73	5.78	4.30	6.19	4.83	6.62	5.28	6.82	6.05
5.0	4.85	3.27	5.48	3.73	5.78	4.30	6.19	4.83	6.62	5.28	6.82	6.05
10.0	4.85	3.27	5.48	3.73	5.78	4.30	6.19	4.83	6.62	5.28	6.82	6.05
15.0	4.85	3.27	5.48	3.73	5.78	4.30	6.19	4.83	6.62	5.28	6.82	6.05
20.0	4.85	3.27	5.48	3.73	5.78	4.30	6.19	4.83	6.62	5.28	6.82	6.05
25.0	4.85	3.27	5.48	3.73	5.78	4.30	6.19	4.83	6.62	5.28	6.82	6.05
30.0	4.85	3.27	5.48	3.73	5.78	4.30	6.19	4.83	6.62	5.28	6.82	6.05
35.0	4.85	3.27	5.48	3.73	5.78	4.30	6.19	4.83	6.62	5.28	6.82	6.05
40.0	3.59	1.79	4.06	2.04	4.28	2.35	4.58	2.64	4.90	2.89	5.05	3.31
46.0	2.33	0.75	2.63	0.86	2.78	0.99	2.97	1.11	3.18	1.22	3.27	1.39

Model: ASYG22KMTB

Outdoor temperature	Indoor temperature (°CDB / °CWB)											
	18.0 / 12.0		21.0 / 15.0		23.0 / 16.0		27.0 / 19.0		29.0 / 21.0		32.0 / 23.0	
(°CDB)	TC	SHC	TC	SHC	TC	SHC	TC	SHC	TC	SHC	TC	SHC
-10.0	6.12	3.93	6.91	4.48	7.29	5.16	7.80	5.80	8.34	6.34	8.60	7.27
-5.0	6.12	3.93	6.91	4.48	7.29	5.16	7.80	5.80	8.34	6.34	8.60	7.27
0.0	6.12	3.93	6.91	4.48	7.29	5.16	7.80	5.80	8.34	6.34	8.60	7.27
5.0	6.12	3.93	6.91	4.48	7.29	5.16	7.80	5.80	8.34	6.34	8.60	7.27
10.0	6.12	3.93	6.91	4.48	7.29	5.16	7.80	5.80	8.34	6.34	8.60	7.27
15.0	6.12	3.93	6.91	4.48	7.29	5.16	7.80	5.80	8.34	6.34	8.60	7.27
20.0	6.12	3.93	6.91	4.48	7.29	5.16	7.80	5.80	8.34	6.34	8.60	7.27
25.0	6.12	3.93	6.91	4.48	7.29	5.16	7.80	5.80	8.34	6.34	8.60	7.27
30.0	6.12	3.93	6.91	4.48	7.29	5.16	7.80	5.80	8.34	6.34	8.60	7.27
35.0	6.12	3.93	6.91	4.48	7.29	5.16	7.80	5.80	8.34	6.34	8.60	7.27
40.0	4.53	2.15	5.11	2.45	5.39	2.83	5.77	3.17	6.17	3.47	6.36	3.98
46.0	2.94	0.91	3.32	1.03	3.50	1.19	3.74	1.34	4.00	1.46	4.13	1.67

Model: ASYG24KMTB

Outdoor temperature	Indoor temperature (°CDB / °CWB)											
	18.0 / 12.0		21.0 / 15.0		23.0 / 16.0		27.0 / 19.0		29.0 / 21.0		32.0 / 23.0	
(°CDB)	TC	SHC	TC	SHC	TC	SHC	TC	SHC	TC	SHC	TC	SHC
-10.0	6.68	4.31	7.55	4.92	7.96	5.66	8.52	6.36	9.11	6.96	9.39	7.97
-5.0	6.68	4.31	7.55	4.92	7.96	5.66	8.52	6.36	9.11	6.96	9.39	7.97
0.0	6.68	4.31	7.55	4.92	7.96	5.66	8.52	6.36	9.11	6.96	9.39	7.97
5.0	6.68	4.31	7.55	4.92	7.96	5.66	8.52	6.36	9.11	6.96	9.39	7.97
10.0	6.68	4.31	7.55	4.92	7.96	5.66	8.52	6.36	9.11	6.96	9.39	7.97
15.0	6.68	4.31	7.55	4.92	7.96	5.66	8.52	6.36	9.11	6.96	9.39	7.97
20.0	6.68	4.31	7.55	4.92	7.96	5.66	8.52	6.36	9.11	6.96	9.39	7.97
25.0	6.68	4.31	7.55	4.92	7.96	5.66	8.52	6.36	9.11	6.96	9.39	7.97
30.0	6.68	4.31	7.55	4.92	7.96	5.66	8.52	6.36	9.11	6.96	9.39	7.97
35.0	6.68	4.31	7.55	4.92	7.96	5.66	8.52	6.36	9.11	6.96	9.39	7.97
40.0	4.94	2.36	5.59	2.69	5.89	3.10	6.30	3.48	6.74	3.81	6.95	4.36
46.0	3.21	0.99	3.62	1.13	3.82	1.30	4.09	1.47	4.37	1.60	4.51	1.84

OUTDOOR UNIT
AOYG36KBTAsOUTDOOR UNIT
AOYG36KBTAs

Model: ASYG07KMTB

Outdoor temperature	Indoor temperature (°CDB / °CWB)											
	18.0 / 12.0		21.0 / 15.0		23.0 / 16.0		27.0 / 19.0		29.0 / 21.0		32.0 / 23.0	
(°CDB)	TC	SHC	TC	SHC	TC	SHC	TC	SHC	TC	SHC	TC	SHC
-10.0	1.96	1.10	2.22	1.26	2.34	1.45	2.50	1.63	2.67	1.78	2.76	2.04
-5.0	1.96	1.10	2.22	1.26	2.34	1.45	2.50	1.63	2.67	1.78	2.76	2.04
0.0	1.96	1.10	2.22	1.26	2.34	1.45	2.50	1.63	2.67	1.78	2.76	2.04
5.0	1.96	1.10	2.22	1.26	2.34	1.45	2.50	1.63	2.67	1.78	2.76	2.04
10.0	1.96	1.10	2.22	1.26	2.34	1.45	2.50	1.63	2.67	1.78	2.76	2.04
15.0	1.96	1.10	2.22	1.26	2.34	1.45	2.50	1.63	2.67	1.78	2.76	2.04
20.0	1.96	1.10	2.22	1.26	2.34	1.45	2.50	1.63	2.67	1.78	2.76	2.04
25.0	1.96	1.10	2.22	1.26	2.34	1.45	2.50	1.63	2.67	1.78	2.76	2.04
30.0	1.96	1.10	2.22	1.26	2.34	1.45	2.50	1.63	2.67	1.78	2.76	2.04
35.0	1.96	1.10	2.22	1.26	2.34	1.45	2.50	1.63	2.67	1.78	2.76	2.04
40.0	1.45	0.60	1.64	0.69	1.73	0.79	1.85	0.89	1.98	0.97	2.04	1.12
46.0	0.94	0.25	1.06	0.29	1.12	0.33	1.20	0.37	1.28	0.41	1.32	0.47

Model: ASYG09KMTB

Outdoor temperature	Indoor temperature (°CDB / °CWB)											
	18.0 / 12.0		21.0 / 15.0		23.0 / 16.0		27.0 / 19.0		29.0 / 21.0		32.0 / 23.0	
(°CDB)	TC	SHC	TC	SHC	TC	SHC	TC	SHC	TC	SHC	TC	SHC
-10.0	2.51	1.41	2.84	1.61	2.99	1.85	3.20	2.08	3.42	2.27	3.53	2.61
-5.0	2.51	1.41	2.84	1.61	2.99	1.85	3.20	2.08	3.42	2.27	3.53	2.61
0.0	2.51	1.41	2.84	1.61	2.99	1.85	3.20	2.08	3.42	2.27	3.53	2.61
5.0	2.51	1.41	2.84	1.61	2.99	1.85	3.20	2.08	3.42	2.27	3.53	2.61
10.0	2.51	1.41	2.84	1.61	2.99	1.85	3.20	2.08	3.42	2.27	3.53	2.61
15.0	2.51	1.41	2.84	1.61	2.99	1.85	3.20	2.08	3.42	2.27	3.53	2.61
20.0	2.51	1.41	2.84	1.61	2.99	1.85	3.20	2.08	3.42	2.27	3.53	2.61
25.0	2.51	1.41	2.84	1.61	2.99	1.85	3.20	2.08	3.42	2.27	3.53	2.61
30.0	2.51	1.41	2.84	1.61	2.99	1.85	3.20	2.08	3.42	2.27	3.53	2.61
35.0	2.51	1.41	2.84	1.61	2.99	1.85	3.20	2.08	3.42	2.27	3.53	2.61
40.0	1.86	0.77	2.10	0.88	2.21	1.01	2.37	1.14	2.53	1.25	2.61	1.43
46.0	1.20	0.32	1.36	0.37	1.43	0.43	1.54	0.48	1.64	0.52	1.69	0.60

Model: ASYG12KMTB

Outdoor temperature	Indoor temperature (°CDB / °CWB)											
	18.0 / 12.0		21.0 / 15.0		23.0 / 16.0		27.0 / 19.0		29.0 / 21.0		32.0 / 23.0	
(°CDB)	TC	SHC	TC	SHC	TC	SHC	TC	SHC	TC	SHC	TC	SHC
-10.0	3.37	1.90	3.81	2.16	4.02	2.49	4.30	2.80	4.60	3.06	4.74	3.50
-5.0	3.37	1.90	3.81	2.16	4.02	2.49	4.30	2.80	4.60	3.06	4.74	3.50
0.0	3.37	1.90	3.81	2.16	4.02	2.49	4.30	2.80	4.60	3.06	4.74	3.50
5.0	3.37	1.90	3.81	2.16	4.02	2.49	4.30	2.80	4.60	3.06	4.74	3.50
10.0	3.37	1.90	3.81	2.16	4.02	2.49	4.30	2.80	4.60	3.06	4.74	3.50
15.0	3.37	1.90	3.81	2.16	4.02	2.49	4.30	2.80	4.60	3.06	4.74	3.50
20.0	3.37	1.90	3.81	2.16	4.02	2.49	4.30	2.80	4.60	3.06	4.74	3.50
25.0	3.37	1.90	3.81	2.16	4.02	2.49	4.30	2.80	4.60	3.06	4.74	3.50
30.0	3.37	1.90	3.81	2.16	4.02	2.49	4.30	2.80	4.60	3.06	4.74	3.50
35.0	3.37	1.90	3.81	2.16	4.02	2.49	4.30	2.80	4.60	3.06	4.74	3.50
40.0	2.49	1.04	2.82	1.18	2.97	1.36	3.18	1.53	3.40	1.67	3.51	1.92
46.0	1.62	0.44	1.83	0.50	1.93	0.57	2.06	0.64	2.21	0.70	2.27	0.81

Model: ASYG14KMTB

Outdoor temperature	Indoor temperature (°CDB / °CWB)											
	18.0 / 12.0		21.0 / 15.0		23.0 / 16.0		27.0 / 19.0		29.0 / 21.0		32.0 / 23.0	
(°CDB)	TC	SHC	TC	SHC	TC	SHC	TC	SHC	TC	SHC	TC	SHC
-10.0	3.92	2.20	4.43	2.51	4.67	2.89	5.00	3.25	5.35	3.55	5.51	4.07
-5.0	3.92	2.20	4.43	2.51	4.67	2.89	5.00	3.25	5.35	3.55	5.51	4.07
0.0	3.92	2.20	4.43	2.51	4.67	2.89	5.00	3.25	5.35	3.55	5.51	4.07
5.0	3.92	2.20	4.43	2.51	4.67	2.89	5.00	3.25	5.35	3.55	5.51	4.07
10.0	3.92	2.20	4.43	2.51	4.67	2.89	5.00	3.25	5.35	3.55	5.51	4.07
15.0	3.92	2.20	4.43	2.51	4.67	2.89	5.00	3.25	5.35	3.55	5.51	4.07
20.0	3.92	2.20	4.43	2.51	4.67	2.89	5.00	3.25	5.35	3.55	5.51	4.07
25.0	3.92	2.20	4.43	2.51	4.67	2.89	5.00	3.25	5.35	3.55	5.51	4.07
30.0	3.92	2.20	4.43	2.51	4.67	2.89	5.00	3.25	5.35	3.55	5.51	4.07
35.0	3.92	2.20	4.43	2.51	4.67	2.89	5.00	3.25	5.35	3.55	5.51	4.07
40.0	2.90	1.21	3.28	1.38	3.46	1.58	3.70	1.78	3.96	1.95	4.08	2.23
46.0	1.88	0.51	2.13	0.58	2.24	0.67	2.40	0.75	2.57	0.82	2.64	0.94

Model: ASYG07KMCC

Outdoor temperature	Indoor temperature (°CDB / °CWB)											
	18.0 / 12.0		21.0 / 15.0		23.0 / 16.0		27.0 / 19.0		29.0 / 21.0		32.0 / 23.0	
(°CDB)	TC	SHC	TC	SHC	TC	SHC	TC	SHC	TC	SHC	TC	SHC
-10.0	1.96	1.10	2.22	1.26	2.34	1.45	2.50	1.63	2.67	1.78	2.76	2.04
-5.0	1.96	1.10	2.22	1.26	2.34	1.45	2.50	1.63	2.67	1.78	2.76	2.04
0.0	1.96	1.10	2.22	1.26	2.34	1.45	2.50	1.63	2.67	1.78	2.76	2.04
5.0	1.96	1.10	2.22	1.26	2.34	1.45	2.50	1.63	2.67	1.78	2.76	2.04
10.0	1.96	1.10	2.22	1.26	2.34	1.45	2.50	1.63	2.67	1.78	2.76	2.04
15.0	1.96	1.10	2.22	1.26	2.34	1.45	2.50	1.63	2.67	1.78	2.76	2.04
20.0	1.96	1.10	2.22	1.26	2.34	1.45	2.50	1.63	2.67	1.78	2.76	2.04
25.0	1.96	1.10	2.22	1.26	2.34	1.45	2.50	1.63	2.67	1.78	2.76	2.04
30.0	1.96	1.10	2.22	1.26	2.34	1.45	2.50	1.63	2.67	1.78	2.76	2.04
35.0	1.96	1.10	2.22	1.26	2.34	1.45	2.50	1.63	2.67	1.78	2.76	2.04
40.0	1.45	0.60	1.64	0.69	1.73	0.79	1.85	0.89	1.98	0.97	2.04	1.12
46.0	0.94	0.25	1.06	0.29	1.12	0.33	1.20	0.37	1.28	0.41	1.32	0.47

Model: ASYG09KMCC

Outdoor temperature	Indoor temperature (°CDB / °CWB)											
	18.0 / 12.0		21.0 / 15.0		23.0 / 16.0		27.0 / 19.0		29.0 / 21.0		32.0 / 23.0	
(°CDB)	TC	SHC	TC	SHC	TC	SHC	TC	SHC	TC	SHC	TC	SHC
-10.0	2.51	1.41	2.84	1.61	2.99	1.85	3.20	2.08	3.42	2.27	3.53	2.61
-5.0	2.51	1.41	2.84	1.61	2.99	1.85	3.20	2.08	3.42	2.27	3.53	2.61
0.0	2.51	1.41	2.84	1.61	2.99	1.85	3.20	2.08	3.42	2.27	3.53	2.61
5.0	2.51	1.41	2.84	1.61	2.99	1.85	3.20	2.08	3.42	2.27	3.53	2.61
10.0	2.51	1.41	2.84	1.61	2.99	1.85	3.20	2.08	3.42	2.27	3.53	2.61
15.0	2.51	1.41	2.84	1.61	2.99	1.85	3.20	2.08	3.42	2.27	3.53	2.61
20.0	2.51	1.41	2.84	1.61	2.99	1.85	3.20	2.08	3.42	2.27	3.53	2.61
25.0	2.51	1.41	2.84	1.61	2.99	1.85	3.20	2.08	3.42	2.27	3.53	2.61
30.0	2.51	1.41	2.84	1.61	2.99	1.85	3.20	2.08	3.42	2.27	3.53	2.61
35.0	2.51	1.41	2.84	1.61	2.99	1.85	3.20	2.08	3.42	2.27	3.53	2.61
40.0	1.86	0.77	2.10	0.88	2.21	1.01	2.37	1.14	2.53	1.25	2.61	1.43
46.0	1.20	0.32	1.36	0.37	1.43	0.43	1.54	0.48	1.64	0.52	1.69	0.60

Model: ASYG12KMCC

Outdoor temperature	Indoor temperature (°CDB / °CWB)											
	18.0 / 12.0		21.0 / 15.0		23.0 / 16.0		27.0 / 19.0		29.0 / 21.0		32.0 / 23.0	
(°CDB)	TC	SHC	TC	SHC	TC	SHC	TC	SHC	TC	SHC	TC	SHC
-10.0	3.37	1.90	3.81	2.16	4.02	2.49	4.30	2.80	4.60	3.06	4.74	3.50
-5.0	3.37	1.90	3.81	2.16	4.02	2.49	4.30	2.80	4.60	3.06	4.74	3.50
0.0	3.37	1.90	3.81	2.16	4.02	2.49	4.30	2.80	4.60	3.06	4.74	3.50
5.0	3.37	1.90	3.81	2.16	4.02	2.49	4.30	2.80	4.60	3.06	4.74	3.50
10.0	3.37	1.90	3.81	2.16	4.02	2.49	4.30	2.80	4.60	3.06	4.74	3.50
15.0	3.37	1.90	3.81	2.16	4.02	2.49	4.30	2.80	4.60	3.06	4.74	3.50
20.0	3.37	1.90	3.81	2.16	4.02	2.49	4.30	2.80	4.60	3.06	4.74	3.50
25.0	3.37	1.90	3.81	2.16	4.02	2.49	4.30	2.80	4.60	3.06	4.74	3.50
30.0	3.37	1.90	3.81	2.16	4.02	2.49	4.30	2.80	4.60	3.06	4.74	3.50
35.0	3.37	1.90	3.81	2.16	4.02	2.49	4.30	2.80	4.60	3.06	4.74	3.50
40.0	2.49	1.04	2.82	1.18	2.97	1.36	3.18	1.53	3.40	1.67	3.51	1.92
46.0	1.62	0.44	1.83	0.50	1.93	0.57	2.06	0.64	2.21	0.70	2.27	0.81

Model: ASYG14KMCC

Outdoor temperature	Indoor temperature (°CDB / °CWB)											
	18.0 / 12.0		21.0 / 15.0		23.0 / 16.0		27.0 / 19.0		29.0 / 21.0		32.0 / 23.0	
(°CDB)	TC	SHC	TC	SHC	TC	SHC	TC	SHC	TC	SHC	TC	SHC
-10.0	3.92	2.20	4.43	2.51	4.67	2.89	5.00	3.25	5.35	3.55	5.51	4.07
-5.0	3.92	2.20	4.43	2.51	4.67	2.89	5.00	3.25	5.35	3.55	5.51	4.07
0.0	3.92	2.20	4.43	2.51	4.67	2.89	5.00	3.25	5.35	3.55	5.51	4.07
5.0	3.92	2.20	4.43	2.51	4.67	2.89	5.00	3.25	5.35	3.55	5.51	4.07
10.0	3.92	2.20	4.43	2.51	4.67	2.89	5.00	3.25	5.35	3.55	5.51	4.07
15.0	3.92	2.20	4.43	2.51	4.67	2.89	5.00	3.25	5.35	3.55	5.51	4.07
20.0	3.92	2.20	4.43	2.51	4.67	2.89	5.00	3.25	5.35	3.55	5.51	4.07
25.0	3.92	2.20	4.43	2.51	4.67	2.89	5.00	3.25	5.35	3.55	5.51	4.07
30.0	3.92	2.20	4.43	2.51	4.67	2.89	5.00	3.25	5.35	3.55	5.51	4.07
35.0	3.92	2.20	4.43	2.51	4.67	2.89	5.00	3.25	5.35	3.55	5.51	4.07
40.0	2.90	1.21	3.28	1.38	3.46	1.58	3.70	1.78	3.96	1.95	4.08	2.23
46.0	1.88	0.51	2.13	0.58	2.24	0.67	2.40	0.75	2.57	0.82	2.64	0.94

Model: ASYG07KETA, ASYG07KETA-B

Outdoor temperature	Indoor temperature (°CDB / °CWB)											
	18.0 / 12.0		21.0 / 15.0		23.0 / 16.0		27.0 / 19.0		29.0 / 21.0		32.0 / 23.0	
(°CDB)	TC	SHC	TC	SHC	TC	SHC	TC	SHC	TC	SHC	TC	SHC
-10.0	1.96	1.10	2.22	1.26	2.34	1.45	2.50	1.63	2.67	1.78	2.76	2.04
-5.0	1.96	1.10	2.22	1.26	2.34	1.45	2.50	1.63	2.67	1.78	2.76	2.04
0.0	1.96	1.10	2.22	1.26	2.34	1.45	2.50	1.63	2.67	1.78	2.76	2.04
5.0	1.96	1.10	2.22	1.26	2.34	1.45	2.50	1.63	2.67	1.78	2.76	2.04
10.0	1.96	1.10	2.22	1.26	2.34	1.45	2.50	1.63	2.67	1.78	2.76	2.04
15.0	1.96	1.10	2.22	1.26	2.34	1.45	2.50	1.63	2.67	1.78	2.76	2.04
20.0	1.96	1.10	2.22	1.26	2.34	1.45	2.50	1.63	2.67	1.78	2.76	2.04
25.0	1.96	1.10	2.22	1.26	2.34	1.45	2.50	1.63	2.67	1.78	2.76	2.04
30.0	1.96	1.10	2.22	1.26	2.34	1.45	2.50	1.63	2.67	1.78	2.76	2.04
35.0	1.96	1.10	2.22	1.26	2.34	1.45	2.50	1.63	2.67	1.78	2.76	2.04
40.0	1.45	0.60	1.64	0.69	1.73	0.79	1.85	0.89	1.98	0.97	2.04	1.12
46.0	0.94	0.25	1.06	0.29	1.12	0.33	1.20	0.37	1.28	0.41	1.32	0.47

Model: ASYG09KETA, ASYG09KETA-B

Outdoor temperature	Indoor temperature (°CDB / °CWB)											
	18.0 / 12.0		21.0 / 15.0		23.0 / 16.0		27.0 / 19.0		29.0 / 21.0		32.0 / 23.0	
(°CDB)	TC	SHC	TC	SHC	TC	SHC	TC	SHC	TC	SHC	TC	SHC
-10.0	2.51	1.41	2.84	1.61	2.99	1.85	3.20	2.08	3.42	2.27	3.53	2.61
-5.0	2.51	1.41	2.84	1.61	2.99	1.85	3.20	2.08	3.42	2.27	3.53	2.61
0.0	2.51	1.41	2.84	1.61	2.99	1.85	3.20	2.08	3.42	2.27	3.53	2.61
5.0	2.51	1.41	2.84	1.61	2.99	1.85	3.20	2.08	3.42	2.27	3.53	2.61
10.0	2.51	1.41	2.84	1.61	2.99	1.85	3.20	2.08	3.42	2.27	3.53	2.61
15.0	2.51	1.41	2.84	1.61	2.99	1.85	3.20	2.08	3.42	2.27	3.53	2.61
20.0	2.51	1.41	2.84	1.61	2.99	1.85	3.20	2.08	3.42	2.27	3.53	2.61
25.0	2.51	1.41	2.84	1.61	2.99	1.85	3.20	2.08	3.42	2.27	3.53	2.61
30.0	2.51	1.41	2.84	1.61	2.99	1.85	3.20	2.08	3.42	2.27	3.53	2.61
35.0	2.51	1.41	2.84	1.61	2.99	1.85	3.20	2.08	3.42	2.27	3.53	2.61
40.0	1.86	0.77	2.10	0.88	2.21	1.01	2.37	1.14	2.53	1.25	2.61	1.43
46.0	1.20	0.32	1.36	0.37	1.43	0.43	1.54	0.48	1.64	0.52	1.69	0.60

Model: ASYG12KETA, ASYG12KETA-B

Outdoor temperature	Indoor temperature (°CDB / °CWB)											
	18.0 / 12.0		21.0 / 15.0		23.0 / 16.0		27.0 / 19.0		29.0 / 21.0		32.0 / 23.0	
(°CDB)	TC	SHC	TC	SHC	TC	SHC	TC	SHC	TC	SHC	TC	SHC
-10.0	3.37	1.90	3.81	2.16	4.02	2.49	4.30	2.80	4.60	3.06	4.74	3.50
-5.0	3.37	1.90	3.81	2.16	4.02	2.49	4.30	2.80	4.60	3.06	4.74	3.50
0.0	3.37	1.90	3.81	2.16	4.02	2.49	4.30	2.80	4.60	3.06	4.74	3.50
5.0	3.37	1.90	3.81	2.16	4.02	2.49	4.30	2.80	4.60	3.06	4.74	3.50
10.0	3.37	1.90	3.81	2.16	4.02	2.49	4.30	2.80	4.60	3.06	4.74	3.50
15.0	3.37	1.90	3.81	2.16	4.02	2.49	4.30	2.80	4.60	3.06	4.74	3.50
20.0	3.37	1.90	3.81	2.16	4.02	2.49	4.30	2.80	4.60	3.06	4.74	3.50
25.0	3.37	1.90	3.81	2.16	4.02	2.49	4.30	2.80	4.60	3.06	4.74	3.50
30.0	3.37	1.90	3.81	2.16	4.02	2.49	4.30	2.80	4.60	3.06	4.74	3.50
35.0	3.37	1.90	3.81	2.16	4.02	2.49	4.30	2.80	4.60	3.06	4.74	3.50
40.0	2.49	1.04	2.82	1.18	2.97	1.36	3.18	1.53	3.40	1.67	3.51	1.92
46.0	1.62	0.44	1.83	0.50	1.93	0.57	2.06	0.64	2.21	0.70	2.27	0.81

Model: ASYG14KETA, ASYG14KETA-B

Outdoor temperature	Indoor temperature (°CDB / °CWB)											
	18.0 / 12.0		21.0 / 15.0		23.0 / 16.0		27.0 / 19.0		29.0 / 21.0		32.0 / 23.0	
(°CDB)	TC	SHC	TC	SHC	TC	SHC	TC	SHC	TC	SHC	TC	SHC
-10.0	3.92	2.20	4.43	2.51	4.67	2.89	5.00	3.25	5.35	3.55	5.51	4.07
-5.0	3.92	2.20	4.43	2.51	4.67	2.89	5.00	3.25	5.35	3.55	5.51	4.07
0.0	3.92	2.20	4.43	2.51	4.67	2.89	5.00	3.25	5.35	3.55	5.51	4.07
5.0	3.92	2.20	4.43	2.51	4.67	2.89	5.00	3.25	5.35	3.55	5.51	4.07
10.0	3.92	2.20	4.43	2.51	4.67	2.89	5.00	3.25	5.35	3.55	5.51	4.07
15.0	3.92	2.20	4.43	2.51	4.67	2.89	5.00	3.25	5.35	3.55	5.51	4.07
20.0	3.92	2.20	4.43	2.51	4.67	2.89	5.00	3.25	5.35	3.55	5.51	4.07
25.0	3.92	2.20	4.43	2.51	4.67	2.89	5.00	3.25	5.35	3.55	5.51	4.07
30.0	3.92	2.20	4.43	2.51	4.67	2.89	5.00	3.25	5.35	3.55	5.51	4.07
35.0	3.92	2.20	4.43	2.51	4.67	2.89	5.00	3.25	5.35	3.55	5.51	4.07
40.0	2.90	1.21	3.28	1.38	3.46	1.58	3.70	1.78	3.96	1.95	4.08	2.23
46.0	1.88	0.51	2.13	0.58	2.24	0.67	2.40	0.75	2.57	0.82	2.64	0.94

NOTES:

- TC: Total Capacity (kW), SHC: Sensible Heat Capacity (kW)
- Values mentioned in the table are based on the following conditions:
 - Pipe length: 5 m, Height difference: 0 m (Outdoor unit—Indoor unit)

● Ceiling type

Model: ABYG18KRTA

Outdoor temperature	Indoor temperature (°CDB / °CWB)											
	18.0 / 12.0		21.0 / 15.0		23.0 / 16.0		27.0 / 19.0		29.0 / 21.0		32.0 / 23.0	
(°CDB)	TC	SHC	TC	SHC	TC	SHC	TC	SHC	TC	SHC	TC	SHC
-10.0	4.85	3.02	5.48	3.45	5.78	3.97	6.19	4.46	6.62	4.87	6.82	5.58
-5.0	4.85	3.02	5.48	3.45	5.78	3.97	6.19	4.46	6.62	4.87	6.82	5.58
0.0	4.85	3.02	5.48	3.45	5.78	3.97	6.19	4.46	6.62	4.87	6.82	5.58
5.0	4.85	3.02	5.48	3.45	5.78	3.97	6.19	4.46	6.62	4.87	6.82	5.58
10.0	4.85	3.02	5.48	3.45	5.78	3.97	6.19	4.46	6.62	4.87	6.82	5.58
15.0	4.85	3.02	5.48	3.45	5.78	3.97	6.19	4.46	6.62	4.87	6.82	5.58
20.0	4.85	3.02	5.48	3.45	5.78	3.97	6.19	4.46	6.62	4.87	6.82	5.58
25.0	4.85	3.02	5.48	3.45	5.78	3.97	6.19	4.46	6.62	4.87	6.82	5.58
30.0	4.85	3.02	5.48	3.45	5.78	3.97	6.19	4.46	6.62	4.87	6.82	5.58
35.0	4.85	3.02	5.48	3.45	5.78	3.97	6.19	4.46	6.62	4.87	6.82	5.58
40.0	3.59	1.66	4.06	1.89	4.28	2.17	4.58	2.44	4.90	2.67	5.05	3.06
46.0	2.33	0.70	2.63	0.79	2.78	0.91	2.97	1.03	3.18	1.12	3.27	1.29

Model: ABYG22KRTA

Outdoor temperature	Indoor temperature (°CDB / °CWB)											
	18.0 / 12.0		21.0 / 15.0		23.0 / 16.0		27.0 / 19.0		29.0 / 21.0		32.0 / 23.0	
(°CDB)	TC	SHC	TC	SHC	TC	SHC	TC	SHC	TC	SHC	TC	SHC
-10.0	6.12	3.80	6.91	4.33	7.29	4.99	7.80	5.60	8.34	6.13	8.60	7.02
-5.0	6.12	3.80	6.91	4.33	7.29	4.99	7.80	5.60	8.34	6.13	8.60	7.02
0.0	6.12	3.80	6.91	4.33	7.29	4.99	7.80	5.60	8.34	6.13	8.60	7.02
5.0	6.12	3.80	6.91	4.33	7.29	4.99	7.80	5.60	8.34	6.13	8.60	7.02
10.0	6.12	3.80	6.91	4.33	7.29	4.99	7.80	5.60	8.34	6.13	8.60	7.02
15.0	6.12	3.80	6.91	4.33	7.29	4.99	7.80	5.60	8.34	6.13	8.60	7.02
20.0	6.12	3.80	6.91	4.33	7.29	4.99	7.80	5.60	8.34	6.13	8.60	7.02
25.0	6.12	3.80	6.91	4.33	7.29	4.99	7.80	5.60	8.34	6.13	8.60	7.02
30.0	6.12	3.80	6.91	4.33	7.29	4.99	7.80	5.60	8.34	6.13	8.60	7.02
35.0	6.12	3.80	6.91	4.33	7.29	4.99	7.80	5.60	8.34	6.13	8.60	7.02
40.0	4.53	2.08	5.11	2.37	5.39	2.73	5.77	3.07	6.17	3.36	6.36	3.84
46.0	2.94	0.88	3.32	1.00	3.50	1.15	3.74	1.29	4.00	1.41	4.13	1.62

NOTES:

- TC: Total Capacity (kW), SHC: Sensible Heat Capacity (kW)
- Values mentioned in the table are based on the following conditions:
 - Pipe length: 5 m, Height difference: 0 m (Outdoor unit—Indoor unit)

● Floor type

Model: AGYG09KVCA

Outdoor temperature	Indoor temperature (°CDB / °CWB)											
	18.0 / 12.0		21.0 / 15.0		23.0 / 16.0		27.0 / 19.0		29.0 / 21.0		32.0 / 23.0	
(°CDB)	TC	SHC	TC	SHC	TC	SHC	TC	SHC	TC	SHC	TC	SHC
-10.0	2.51	1.71	2.84	1.95	2.99	2.25	3.20	2.53	3.42	2.76	3.53	3.17
-5.0	2.51	1.71	2.84	1.95	2.99	2.25	3.20	2.53	3.42	2.76	3.53	3.17
0.0	2.51	1.71	2.84	1.95	2.99	2.25	3.20	2.53	3.42	2.76	3.53	3.17
5.0	2.51	1.71	2.84	1.95	2.99	2.25	3.20	2.53	3.42	2.76	3.53	3.17
10.0	2.51	1.71	2.84	1.95	2.99	2.25	3.20	2.53	3.42	2.76	3.53	3.17
15.0	2.51	1.71	2.84	1.95	2.99	2.25	3.20	2.53	3.42	2.76	3.53	3.17
20.0	2.51	1.71	2.84	1.95	2.99	2.25	3.20	2.53	3.42	2.76	3.53	3.17
25.0	2.51	1.71	2.84	1.95	2.99	2.25	3.20	2.53	3.42	2.76	3.53	3.17
30.0	2.51	1.71	2.84	1.95	2.99	2.25	3.20	2.53	3.42	2.76	3.53	3.17
35.0	2.51	1.71	2.84	1.95	2.99	2.25	3.20	2.53	3.42	2.76	3.53	3.17
40.0	1.86	0.94	2.10	1.07	2.21	1.23	2.37	1.38	2.53	1.51	2.61	1.73
46.0	1.20	0.39	1.36	0.45	1.43	0.52	1.54	0.58	1.64	0.64	1.69	0.73

Model: AGYG12KVCA

Outdoor temperature	Indoor temperature (°CDB / °CWB)											
	18.0 / 12.0		21.0 / 15.0		23.0 / 16.0		27.0 / 19.0		29.0 / 21.0		32.0 / 23.0	
(°CDB)	TC	SHC	TC	SHC	TC	SHC	TC	SHC	TC	SHC	TC	SHC
-10.0	3.37	2.16	3.81	2.46	4.02	2.83	4.30	3.18	4.60	3.48	4.74	3.99
-5.0	3.37	2.16	3.81	2.46	4.02	2.83	4.30	3.18	4.60	3.48	4.74	3.99
0.0	3.37	2.16	3.81	2.46	4.02	2.83	4.30	3.18	4.60	3.48	4.74	3.99
5.0	3.37	2.16	3.81	2.46	4.02	2.83	4.30	3.18	4.60	3.48	4.74	3.99
10.0	3.37	2.16	3.81	2.46	4.02	2.83	4.30	3.18	4.60	3.48	4.74	3.99
15.0	3.37	2.16	3.81	2.46	4.02	2.83	4.30	3.18	4.60	3.48	4.74	3.99
20.0	3.37	2.16	3.81	2.46	4.02	2.83	4.30	3.18	4.60	3.48	4.74	3.99
25.0	3.37	2.16	3.81	2.46	4.02	2.83	4.30	3.18	4.60	3.48	4.74	3.99
30.0	3.37	2.16	3.81	2.46	4.02	2.83	4.30	3.18	4.60	3.48	4.74	3.99
35.0	3.37	2.16	3.81	2.46	4.02	2.83	4.30	3.18	4.60	3.48	4.74	3.99
40.0	2.49	1.18	2.82	1.35	2.97	1.55	3.18	1.74	3.40	1.91	3.51	2.18
46.0	1.62	0.50	1.83	0.57	1.93	0.65	2.06	0.73	2.21	0.80	2.27	0.92

Model: AGYG14KVCA

Outdoor temperature	Indoor temperature (°CDB / °CWB)											
	18.0 / 12.0		21.0 / 15.0		23.0 / 16.0		27.0 / 19.0		29.0 / 21.0		32.0 / 23.0	
(°CDB)	TC	SHC	TC	SHC	TC	SHC	TC	SHC	TC	SHC	TC	SHC
-10.0	3.92	2.44	4.43	2.78	4.67	3.20	5.00	3.60	5.35	3.94	5.51	4.51
-5.0	3.92	2.44	4.43	2.78	4.67	3.20	5.00	3.60	5.35	3.94	5.51	4.51
0.0	3.92	2.44	4.43	2.78	4.67	3.20	5.00	3.60	5.35	3.94	5.51	4.51
5.0	3.92	2.44	4.43	2.78	4.67	3.20	5.00	3.60	5.35	3.94	5.51	4.51
10.0	3.92	2.44	4.43	2.78	4.67	3.20	5.00	3.60	5.35	3.94	5.51	4.51
15.0	3.92	2.44	4.43	2.78	4.67	3.20	5.00	3.60	5.35	3.94	5.51	4.51
20.0	3.92	2.44	4.43	2.78	4.67	3.20	5.00	3.60	5.35	3.94	5.51	4.51
25.0	3.92	2.44	4.43	2.78	4.67	3.20	5.00	3.60	5.35	3.94	5.51	4.51
30.0	3.92	2.44	4.43	2.78	4.67	3.20	5.00	3.60	5.35	3.94	5.51	4.51
35.0	3.92	2.44	4.43	2.78	4.67	3.20	5.00	3.60	5.35	3.94	5.51	4.51
40.0	2.90	1.34	3.28	1.52	3.46	1.75	3.70	1.97	3.96	2.16	4.08	2.47
46.0	1.88	0.56	2.13	0.64	2.24	0.74	2.40	0.83	2.57	0.91	2.64	1.04

NOTES:

- TC: Total Capacity (kW), SHC: Sensible Heat Capacity (kW)
- Values mentioned in the table are based on the following conditions:
 - Pipe length: 5 m, Height difference: 0 m (Outdoor unit—Indoor unit)

6-3. Heating capacity

NOTE: Values mentioned in the table are calculated based on the maximum capacity.

Model: AOYG36KBTA5

OUTDOOR UNIT
AOYG36KBTA5

OUTDOOR UNIT
AOYG36KBTA5

Indoor unit connecting capacity	Outdoor temperature		Indoor temperature									
			16.0 °CDB		18.0 °CDB		20.0 °CDB		22.0 °CDB		24.0 °CDB	
kBtu/h	°CDB	°CWB	TC	IP	TC	IP	TC	IP	TC	IP	TC	IP
54	-15.0	-16.0	7.8	2.88	7.6	2.94	7.4	3.00	7.2	3.06	7.0	3.12
	-10.0	-11.0	9.1	3.25	8.9	3.32	8.7	3.39	8.5	3.46	8.2	3.53
	-5.0	-7.0	9.5	2.93	9.3	2.99	9.1	3.05	8.8	3.11	8.6	3.17
	0.0	-2.0	10.9	3.13	10.7	3.19	10.4	3.26	10.2	3.32	9.9	3.39
	5.0	3.0	12.6	3.29	12.3	3.36	12.0	3.42	11.7	3.49	11.4	3.56
	7.0	6.0	12.6	3.13	12.3	3.20	12.0	3.26	11.7	3.33	11.4	3.39
	10.0	8.0	12.6	2.90	12.3	2.96	12.0	3.02	11.7	3.08	11.4	3.14
	15.0	10.0	12.6	2.72	12.3	2.78	12.0	2.84	11.7	2.89	11.4	2.95
	20.0	15.0	12.6	2.36	12.3	2.41	12.0	2.46	11.7	2.51	11.4	2.56
24.0	18.0	12.6	2.00	12.3	2.04	12.0	2.08	11.7	2.12	11.4	2.16	
53	-15.0	-16.0	7.8	2.88	7.6	2.94	7.4	3.00	7.2	3.06	7.0	3.12
	-10.0	-11.0	9.1	3.25	8.9	3.32	8.7	3.39	8.5	3.46	8.2	3.53
	-5.0	-7.0	9.5	2.93	9.3	2.99	9.1	3.05	8.8	3.11	8.6	3.17
	0.0	-2.0	10.9	3.13	10.7	3.19	10.4	3.26	10.2	3.32	9.9	3.39
	5.0	3.0	12.6	3.29	12.3	3.36	12.0	3.42	11.7	3.49	11.4	3.56
	7.0	6.0	12.6	3.13	12.3	3.20	12.0	3.26	11.7	3.33	11.4	3.39
	10.0	8.0	12.6	2.90	12.3	2.96	12.0	3.02	11.7	3.08	11.4	3.14
	15.0	10.0	12.6	2.72	12.3	2.78	12.0	2.84	11.7	2.89	11.4	2.95
	20.0	15.0	12.6	2.36	12.3	2.41	12.0	2.46	11.7	2.51	11.4	2.56
24.0	18.0	12.6	2.00	12.3	2.04	12.0	2.08	11.7	2.12	11.4	2.16	
52	-15.0	-16.0	7.8	2.88	7.6	2.94	7.4	3.00	7.2	3.06	7.0	3.12
	-10.0	-11.0	9.1	3.25	8.9	3.32	8.7	3.39	8.5	3.46	8.2	3.53
	-5.0	-7.0	9.5	2.93	9.3	2.99	9.1	3.05	8.8	3.11	8.6	3.17
	0.0	-2.0	10.9	3.13	10.7	3.19	10.4	3.26	10.2	3.32	9.9	3.39
	5.0	3.0	12.6	3.29	12.3	3.36	12.0	3.42	11.7	3.49	11.4	3.56
	7.0	6.0	12.6	3.13	12.3	3.20	12.0	3.26	11.7	3.33	11.4	3.39
	10.0	8.0	12.6	2.90	12.3	2.96	12.0	3.02	11.7	3.08	11.4	3.14
	15.0	10.0	12.6	2.72	12.3	2.78	12.0	2.84	11.7	2.89	11.4	2.95
	20.0	15.0	12.6	2.36	12.3	2.41	12.0	2.46	11.7	2.51	11.4	2.56
24.0	18.0	12.6	2.00	12.3	2.04	12.0	2.08	11.7	2.12	11.4	2.16	
51	-15.0	-16.0	7.8	2.88	7.6	2.94	7.4	3.00	7.2	3.06	7.0	3.12
	-10.0	-11.0	9.1	3.25	8.9	3.32	8.7	3.39	8.5	3.46	8.2	3.53
	-5.0	-7.0	9.5	2.93	9.3	2.99	9.1	3.05	8.8	3.11	8.6	3.17
	0.0	-2.0	10.9	3.13	10.7	3.19	10.4	3.26	10.2	3.32	9.9	3.39
	5.0	3.0	12.6	3.29	12.3	3.36	12.0	3.42	11.7	3.49	11.4	3.56
	7.0	6.0	12.6	3.13	12.3	3.20	12.0	3.26	11.7	3.33	11.4	3.39
	10.0	8.0	12.6	2.90	12.3	2.96	12.0	3.02	11.7	3.08	11.4	3.14
	15.0	10.0	12.6	2.72	12.3	2.78	12.0	2.84	11.7	2.89	11.4	2.95
	20.0	15.0	12.6	2.36	12.3	2.41	12.0	2.46	11.7	2.51	11.4	2.56
24.0	18.0	12.6	2.00	12.3	2.04	12.0	2.08	11.7	2.12	11.4	2.16	
50	-15.0	-16.0	7.8	2.88	7.6	2.94	7.4	3.00	7.2	3.06	7.0	3.12
	-10.0	-11.0	9.1	3.25	8.9	3.32	8.7	3.39	8.5	3.46	8.2	3.53
	-5.0	-7.0	9.5	2.93	9.3	2.99	9.1	3.05	8.8	3.11	8.6	3.17
	0.0	-2.0	10.9	3.13	10.7	3.19	10.4	3.26	10.2	3.32	9.9	3.39
	5.0	3.0	12.6	3.29	12.3	3.36	12.0	3.42	11.7	3.49	11.4	3.56
	7.0	6.0	12.6	3.13	12.3	3.20	12.0	3.26	11.7	3.33	11.4	3.39
	10.0	8.0	12.6	2.90	12.3	2.96	12.0	3.02	11.7	3.08	11.4	3.14
	15.0	10.0	12.6	2.72	12.3	2.78	12.0	2.84	11.7	2.89	11.4	2.95
	20.0	15.0	12.6	2.36	12.3	2.41	12.0	2.46	11.7	2.51	11.4	2.56
24.0	18.0	12.6	2.00	12.3	2.04	12.0	2.08	11.7	2.12	11.4	2.16	
49	-15.0	-16.0	7.8	2.88	7.6	2.94	7.4	3.00	7.2	3.06	7.0	3.12
	-10.0	-11.0	9.1	3.25	8.9	3.32	8.7	3.39	8.5	3.46	8.2	3.53
	-5.0	-7.0	9.5	2.93	9.3	2.99	9.1	3.05	8.8	3.11	8.6	3.17
	0.0	-2.0	10.9	3.13	10.7	3.19	10.4	3.26	10.2	3.32	9.9	3.39
	5.0	3.0	12.6	3.29	12.3	3.36	12.0	3.42	11.7	3.49	11.4	3.56
	7.0	6.0	12.6	3.13	12.3	3.20	12.0	3.26	11.7	3.33	11.4	3.39
	10.0	8.0	12.6	2.90	12.3	2.96	12.0	3.02	11.7	3.08	11.4	3.14
	15.0	10.0	12.6	2.72	12.3	2.78	12.0	2.84	11.7	2.89	11.4	2.95
	20.0	15.0	12.6	2.36	12.3	2.41	12.0	2.46	11.7	2.51	11.4	2.56
24.0	18.0	12.6	2.00	12.3	2.04	12.0	2.08	11.7	2.12	11.4	2.16	
48	-15.0	-16.0	7.8	2.88	7.6	2.94	7.4	3.00	7.2	3.06	7.0	3.12
	-10.0	-11.0	9.1	3.25	8.9	3.32	8.7	3.39	8.5	3.46	8.2	3.53
	-5.0	-7.0	9.5	2.93	9.3	2.99	9.1	3.05	8.8	3.11	8.6	3.17
	0.0	-2.0	10.9	3.13	10.7	3.19	10.4	3.26	10.2	3.32	9.9	3.39
	5.0	3.0	12.6	3.29	12.3	3.36	12.0	3.42	11.7	3.49	11.4	3.56
	7.0	6.0	12.6	3.13	12.3	3.20	12.0	3.26	11.7	3.33	11.4	3.39
	10.0	8.0	12.6	2.90	12.3	2.96	12.0	3.02	11.7	3.08	11.4	3.14
	15.0	10.0	12.6	2.72	12.3	2.78	12.0	2.84	11.7	2.89	11.4	2.95
	20.0	15.0	12.6	2.36	12.3	2.41	12.0	2.46	11.7	2.51	11.4	2.56
24.0	18.0	12.6	2.00	12.3	2.04	12.0	2.08	11.7	2.12	11.4	2.16	
47	-15.0	-16.0	7.8	2.88	7.6	2.94	7.4	3.00	7.2	3.06	7.0	3.12
	-10.0	-11.0	9.1	3.25	8.9	3.32	8.7	3.39	8.5	3.46	8.2	3.53
	-5.0	-7.0	9.5	2.93	9.3	2.99	9.1	3.05	8.8	3.11	8.6	3.17
	0.0	-2.0	10.9	3.13	10.7	3.19	10.4	3.26	10.2	3.32	9.9	3.39
	5.0	3.0	12.6	3.29	12.3	3.36	12.0	3.42	11.7	3.49	11.4	3.56
	7.0	6.0	12.6	3.13	12.3	3.20	12.0	3.26	11.7	3.33	11.4	3.39
	10.0	8.0	12.6	2.90	12.3	2.96	12.0	3.02	11.7	3.08	11.4	3.14
	15.0	10.0	12.6	2.72	12.3	2.78	12.0	2.84	11.7	2.89	11.4	2.95
	20.0	15.0	12.6	2.36	12.3	2.41	12.0	2.46	11.7	2.51	11.4	2.56
24.0	18.0	12.6	2.00	12.3	2.04	12.0	2.08	11.7	2.12	11.4	2.16	

OUTDOOR UNIT
AOYG36KBTAs

OUTDOOR UNIT
AOYG36KBTAs

Indoor unit connecting capacity	Outdoor temperature		Indoor temperature									
			16.0 °CDB		18.0 °CDB		20.0 °CDB		22.0 °CDB		24.0 °CDB	
	kBtu/h	°CDB	°CWB	TC	IP	TC	IP	TC	IP	TC	IP	TC
37	-15.0	-16.0	7.8	2.88	7.6	2.94	7.4	3.00	7.2	3.06	7.0	3.12
	-10.0	-11.0	9.1	3.25	8.9	3.32	8.7	3.39	8.5	3.46	8.2	3.53
	-5.0	-7.0	9.5	2.93	9.3	2.99	9.1	3.05	8.8	3.11	8.6	3.17
	0.0	-2.0	10.9	3.13	10.7	3.19	10.4	3.26	10.2	3.32	9.9	3.39
	5.0	3.0	12.6	3.29	12.3	3.36	12.0	3.42	11.7	3.49	11.4	3.56
	7.0	6.0	12.6	3.13	12.3	3.20	12.0	3.26	11.7	3.33	11.4	3.39
	10.0	8.0	12.6	2.90	12.3	2.96	12.0	3.02	11.7	3.08	11.4	3.14
	15.0	10.0	12.6	2.72	12.3	2.78	12.0	2.84	11.7	2.89	11.4	2.95
	20.0	15.0	12.6	2.36	12.3	2.41	12.0	2.46	11.7	2.51	11.4	2.56
24.0	18.0	12.6	2.00	12.3	2.04	12.0	2.08	11.7	2.12	11.4	2.16	
36	-15.0	-16.0	7.8	2.88	7.6	2.94	7.4	3.00	7.2	3.06	7.0	3.12
	-10.0	-11.0	9.1	3.25	8.9	3.32	8.7	3.39	8.5	3.46	8.2	3.53
	-5.0	-7.0	9.5	2.93	9.3	2.99	9.1	3.05	8.8	3.11	8.6	3.17
	0.0	-2.0	10.9	3.13	10.7	3.19	10.4	3.26	10.2	3.32	9.9	3.39
	5.0	3.0	12.6	3.29	12.3	3.36	12.0	3.42	11.7	3.49	11.4	3.56
	7.0	6.0	12.6	3.13	12.3	3.20	12.0	3.26	11.7	3.33	11.4	3.39
	10.0	8.0	12.6	2.90	12.3	2.96	12.0	3.02	11.7	3.08	11.4	3.14
	15.0	10.0	12.6	2.72	12.3	2.78	12.0	2.84	11.7	2.89	11.4	2.95
	20.0	15.0	12.6	2.36	12.3	2.41	12.0	2.46	11.7	2.51	11.4	2.56
24.0	18.0	12.6	2.00	12.3	2.04	12.0	2.08	11.7	2.12	11.4	2.16	
35	-15.0	-16.0	7.8	2.88	7.6	2.94	7.4	3.00	7.2	3.06	7.0	3.12
	-10.0	-11.0	9.1	3.25	8.9	3.32	8.7	3.39	8.5	3.46	8.2	3.53
	-5.0	-7.0	9.5	2.93	9.3	2.99	9.1	3.05	8.8	3.11	8.6	3.17
	0.0	-2.0	10.9	3.13	10.7	3.19	10.4	3.26	10.2	3.32	9.9	3.39
	5.0	3.0	12.6	3.29	12.3	3.36	12.0	3.42	11.7	3.49	11.4	3.56
	7.0	6.0	12.6	3.13	12.3	3.20	12.0	3.26	11.7	3.33	11.4	3.39
	10.0	8.0	12.6	2.90	12.3	2.96	12.0	3.02	11.7	3.08	11.4	3.14
	15.0	10.0	12.6	2.72	12.3	2.78	12.0	2.84	11.7	2.89	11.4	2.95
	20.0	15.0	12.6	2.36	12.3	2.41	12.0	2.46	11.7	2.51	11.4	2.56
24.0	18.0	12.6	2.00	12.3	2.04	12.0	2.08	11.7	2.12	11.4	2.16	
34	-15.0	-16.0	7.8	2.82	7.6	2.88	7.4	2.94	7.2	3.00	7.0	3.06
	-10.0	-11.0	9.1	3.19	8.9	3.26	8.7	3.32	8.5	3.39	8.2	3.46
	-5.0	-7.0	9.5	2.87	9.3	2.93	9.1	2.99	8.8	3.05	8.6	3.11
	0.0	-2.0	10.9	3.07	10.7	3.13	10.4	3.19	10.2	3.26	9.9	3.32
	5.0	3.0	12.6	3.22	12.3	3.29	12.0	3.36	11.7	3.43	11.4	3.49
	7.0	6.0	12.6	3.07	12.3	3.14	12.0	3.20	11.7	3.26	11.4	3.33
	10.0	8.0	12.6	2.85	12.3	2.91	12.0	2.97	11.7	3.02	11.4	3.08
	15.0	10.0	12.6	2.67	12.3	2.73	12.0	2.78	11.7	2.84	11.4	2.89
	20.0	15.0	12.6	2.32	12.3	2.36	12.0	2.41	11.7	2.46	11.4	2.51
24.0	18.0	12.6	1.96	12.3	2.00	12.0	2.04	11.7	2.08	11.4	2.12	
33	-15.0	-16.0	7.8	2.82	7.6	2.88	7.4	2.94	7.2	3.00	7.0	3.06
	-10.0	-11.0	9.1	3.19	8.9	3.26	8.7	3.32	8.5	3.39	8.2	3.46
	-5.0	-7.0	9.5	2.87	9.3	2.93	9.1	2.99	8.8	3.05	8.6	3.11
	0.0	-2.0	10.9	3.07	10.7	3.13	10.4	3.19	10.2	3.26	9.9	3.32
	5.0	3.0	12.6	3.22	12.3	3.29	12.0	3.36	11.7	3.43	11.4	3.49
	7.0	6.0	12.6	3.07	12.3	3.14	12.0	3.20	11.7	3.26	11.4	3.33
	10.0	8.0	12.6	2.85	12.3	2.91	12.0	2.97	11.7	3.02	11.4	3.08
	15.0	10.0	12.6	2.67	12.3	2.73	12.0	2.78	11.7	2.84	11.4	2.89
	20.0	15.0	12.6	2.32	12.3	2.36	12.0	2.41	11.7	2.46	11.4	2.51
24.0	18.0	12.6	1.96	12.3	2.00	12.0	2.04	11.7	2.08	11.4	2.12	
32	-15.0	-16.0	7.8	2.82	7.6	2.88	7.4	2.94	7.2	3.00	7.0	3.06
	-10.0	-11.0	9.1	3.19	8.9	3.26	8.7	3.32	8.5	3.39	8.2	3.46
	-5.0	-7.0	9.5	2.87	9.3	2.93	9.1	2.99	8.8	3.05	8.6	3.11
	0.0	-2.0	10.9	3.07	10.7	3.13	10.4	3.19	10.2	3.26	9.9	3.32
	5.0	3.0	12.6	3.22	12.3	3.29	12.0	3.36	11.7	3.43	11.4	3.49
	7.0	6.0	12.6	3.07	12.3	3.14	12.0	3.20	11.7	3.26	11.4	3.33
	10.0	8.0	12.6	2.85	12.3	2.91	12.0	2.97	11.7	3.02	11.4	3.08
	15.0	10.0	12.6	2.67	12.3	2.73	12.0	2.78	11.7	2.84	11.4	2.89
	20.0	15.0	12.6	2.32	12.3	2.36	12.0	2.41	11.7	2.46	11.4	2.51
24.0	18.0	12.6	1.96	12.3	2.00	12.0	2.04	11.7	2.08	11.4	2.12	
31	-15.0	-16.0	7.8	2.82	7.6	2.88	7.4	2.94	7.2	3.00	7.0	3.06
	-10.0	-11.0	9.1	3.19	8.9	3.26	8.7	3.32	8.5	3.39	8.2	3.46
	-5.0	-7.0	9.5	2.87	9.3	2.93	9.1	2.99	8.8	3.05	8.6	3.11
	0.0	-2.0	10.9	3.07	10.7	3.13	10.4	3.19	10.2	3.26	9.9	3.32
	5.0	3.0	12.6	3.22	12.3	3.29	12.0	3.36	11.7	3.43	11.4	3.49
	7.0	6.0	12.6	3.07	12.3	3.14	12.0	3.20	11.7	3.26	11.4	3.33
	10.0	8.0	12.6	2.85	12.3	2.91	12.0	2.97	11.7	3.02	11.4	3.08
	15.0	10.0	12.6	2.67	12.3	2.73	12.0	2.78	11.7	2.84	11.4	2.89
	20.0	15.0	12.6	2.32	12.3	2.36	12.0	2.41	11.7	2.46	11.4	2.51
24.0	18.0	12.6	1.96	12.3	2.00	12.0	2.04	11.7	2.08	11.4	2.12	
30	-15.0	-16.0	7.8	2.82	7.6	2.88	7.4	2.94	7.2	3.00	7.0	3.06
	-10.0	-11.0	9.1	3.19	8.9	3.26	8.7	3.32	8.5	3.39	8.2	3.46
	-5.0	-7.0	9.5	2.87	9.3	2.93	9.1	2.99	8.8	3.05	8.6	3.11
	0.0	-2.0	10.9	3.07	10.7	3.13	10.4	3.19	10.2	3.26	9.9	3.32
	5.0	3.0	12.6	3.22	12.3	3.29	12.0	3.36	11.7	3.43	11.4	3.49
	7.0	6.0	12.6	3.07	12.3	3.14	12.0	3.20	11.7	3.26	11.4	3.33
	10.0	8.0	12.6	2.85	12.3	2.91	12.0	2.97	11.7	3.02	11.4	3.08
	15.0	10.0	12.6	2.67	12.3	2.73	12.0	2.78	11.7	2.84	11.4	2.89
	20.0	15.0	12.6	2.32	12.3	2.36	12.0	2.41	11.7	2.46	11.4	2.51
24.0	18.0	12.6	1.96	12.3	2.00	12.0	2.04	11.7	2.08	11.4	2.12	
28	-15.0	-16.0	7.2	2.61	7.1	2.66	6.9	2.72	6.7	2.77	6.6	2.83
	-10.0	-11.0	8.5	2.95	8.3	3.01	8.1	3.07	7.9	3.13	7.7	3.20
	-5.0	-7.0	8.9	2.66	8.7	2.71	8.5	2.77	8.3	2.82	8.0	2.88
	0.0	-2.0	10.2	2.83	10.0	2.89	9.7	2.95	9.5	3.01	9.2	3.07
	5.0	3.0	11.8	2.98	11.5	3.04	11.2	3.10	10.9	3.17	10.6	3.23
	7.0	6.0	11.8	2.84	11.5	2.90	11.2	2.96	10.9	3.02	10.6	3.08
	10.0	8.0	11.8	2.63	11.5	2.69	11.2	2.74	10.9	2.80	10.6	2.85
	15.0	10.0	11.8	2.47	11.5	2.52	11.2	2.57	10.9	2.62	10.6	2.67
	20.0	15.0	11.8	2.14	11.5	2.19	11.2	2.23	10.9	2.28	10.6	2.32
24.0	18.0	11.8	1.81	11.5	1.85	11.2	1.88	10.9	1.92	10.6	1.96	

Indoor unit connecting capacity	Outdoor temperature		Indoor temperature									
			16.0 °CDB		18.0 °CDB		20.0 °CDB		22.0 °CDB		24.0 °CDB	
	kBtu/h	°CDB	°CWB	TC	IP	TC	IP	TC	IP	TC	IP	TC
27	-15.0	-16.0	7.0	2.50	6.8	2.56	6.7	2.61	6.5	2.66	6.3	2.71
	-10.0	-11.0	8.2	2.83	8.0	2.89	7.8	2.95	7.6	3.01	7.4	3.07
	-5.0	-7.0	8.6	2.55	8.4	2.60	8.2	2.65	8.0	2.71	7.8	2.76
	0.0	-2.0	9.9	2.72	9.6	2.78	9.4	2.83	9.2	2.89	8.9	2.95
	5.0	3.0	11.3	2.86	11.1	2.92	10.8	2.98	10.5	3.04	10.3	3.10
	7.0	6.0	11.3	2.72	11.1	2.78	10.8	2.84	10.5	2.89	10.3	2.95
	10.0	8.0	11.3	2.52	11.1	2.58	10.8	2.63	10.5	2.68	10.3	2.73
	15.0	10.0	11.3	2.37	11.1	2.42	10.8	2.47	10.5	2.52	10.3	2.57
	20.0	15.0	11.3	2.05	11.1	2.10	10.8	2.14	10.5	2.18	10.3	2.22
	24.0	18.0	11.3	1.73	11.1	1.77	10.8	1.81	10.5	1.84	10.3	1.88

NOTES:

- TC: Total Capacity (kW), IP: Input Power (kW)
- Values mentioned in the table are based on the following conditions:
 - Power source of specifications: 230 V
 - Pipe length: 5 m, Height difference: 0 m (Outdoor unit—Indoor unit)
- 2 or more indoor units should be connected.
- The total ability of connected a indoor unit is from 27,000 Btu/h up to 54,000 Btu/h.
- Input in the table are calculated based on the maximum indoor unit input combinations.

● Compact cassette type

Model: AUXG07KVLA

Outdoor temperature		Indoor temperature (°CDB)				
		16.0	18.0	20.0	22.0	24.0
(°CDB)	(°CWB)	TC	TC	TC	TC	TC
-15.0	-16.0	1.82	1.78	1.74	1.69	1.65
-10.0	-11.0	2.12	2.07	2.02	1.97	1.92
-5.0	-7.0	2.23	2.18	2.13	2.07	2.02
0.0	-2.0	2.56	2.50	2.44	2.38	2.31
5.0	3.0	2.94	2.87	2.80	2.73	2.66
7.0	6.0	2.94	2.87	2.80	2.73	2.66
10.0	8.0	2.94	2.87	2.80	2.73	2.66
15.0	10.0	2.94	2.87	2.80	2.73	2.66
20.0	15.0	2.94	2.87	2.80	2.73	2.66
24.0	18.0	2.94	2.87	2.80	2.73	2.66

Model: AUXG09KVLA

Outdoor temperature		Indoor temperature (°CDB)				
		16.0	18.0	20.0	22.0	24.0
(°CDB)	(°CWB)	TC	TC	TC	TC	TC
-15.0	-16.0	2.34	2.29	2.23	2.18	2.12
-10.0	-11.0	2.72	2.66	2.59	2.53	2.46
-5.0	-7.0	2.87	2.80	2.74	2.67	2.60
0.0	-2.0	3.29	3.21	3.13	3.05	2.98
5.0	3.0	3.78	3.69	3.60	3.51	3.42
7.0	6.0	3.78	3.69	3.60	3.51	3.42
10.0	8.0	3.78	3.69	3.60	3.51	3.42
15.0	10.0	3.78	3.69	3.60	3.51	3.42
20.0	15.0	3.78	3.69	3.60	3.51	3.42
24.0	18.0	3.78	3.69	3.60	3.51	3.42

Model: AUXG12KVLA

Outdoor temperature		Indoor temperature (°CDB)				
		16.0	18.0	20.0	22.0	24.0
(°CDB)	(°CWB)	TC	TC	TC	TC	TC
-15.0	-16.0	3.12	3.05	2.98	2.90	2.83
-10.0	-11.0	3.63	3.54	3.46	3.37	3.28
-5.0	-7.0	3.83	3.74	3.65	3.56	3.47
0.0	-2.0	4.38	4.28	4.18	4.07	3.97
5.0	3.0	5.04	4.92	4.80	4.68	4.56
7.0	6.0	5.04	4.92	4.80	4.68	4.56
10.0	8.0	5.04	4.92	4.80	4.68	4.56
15.0	10.0	5.04	4.92	4.80	4.68	4.56
20.0	15.0	5.04	4.92	4.80	4.68	4.56
24.0	18.0	5.04	4.92	4.80	4.68	4.56

Model: AUXG14KVLA

Outdoor temperature		Indoor temperature (°CDB)				
		16.0	18.0	20.0	22.0	24.0
(°CDB)	(°CWB)	TC	TC	TC	TC	TC
-15.0	-16.0	3.65	3.56	3.47	3.39	3.30
-10.0	-11.0	4.23	4.13	4.03	3.93	3.83
-5.0	-7.0	4.47	4.36	4.26	4.15	4.04
0.0	-2.0	5.12	4.99	4.87	4.75	4.63
5.0	3.0	5.88	5.74	5.60	5.46	5.32
7.0	6.0	5.88	5.74	5.60	5.46	5.32
10.0	8.0	5.88	5.74	5.60	5.46	5.32
15.0	10.0	5.88	5.74	5.60	5.46	5.32
20.0	15.0	5.88	5.74	5.60	5.46	5.32
24.0	18.0	5.88	5.74	5.60	5.46	5.32

Model: AUXG18KVLA

Outdoor temperature		Indoor temperature (°CDB)				
		16.0	18.0	20.0	22.0	24.0
(°CDB)	(°CWB)	TC	TC	TC	TC	TC
-15.0	-16.0	4.39	4.29	4.19	4.08	3.98
-10.0	-11.0	5.10	4.98	4.86	4.74	4.62
-5.0	-7.0	5.39	5.26	5.13	5.00	4.87
0.0	-2.0	6.17	6.02	5.87	5.73	5.58
5.0	3.0	7.09	6.92	6.75	6.58	6.41
7.0	6.0	7.09	6.92	6.75	6.58	6.41
10.0	8.0	7.09	6.92	6.75	6.58	6.41
15.0	10.0	7.09	6.92	6.75	6.58	6.41
20.0	15.0	7.09	6.92	6.75	6.58	6.41
24.0	18.0	7.09	6.92	6.75	6.58	6.41

Model: AUXG22KVLA

Outdoor temperature		Indoor temperature (°CDB)				
		16.0	18.0	20.0	22.0	24.0
(°CDB)	(°CWB)	TC	TC	TC	TC	TC
-15.0	-16.0	5.55	5.41	5.28	5.15	5.02
-10.0	-11.0	6.44	6.29	6.13	5.98	5.83
-5.0	-7.0	6.80	6.64	6.48	6.31	6.15
0.0	-2.0	7.78	7.60	7.41	7.23	7.04
5.0	3.0	8.95	8.73	8.52	8.31	8.09
7.0	6.0	8.95	8.73	8.52	8.31	8.09
10.0	8.0	8.95	8.73	8.52	8.31	8.09
15.0	10.0	8.95	8.73	8.52	8.31	8.09
20.0	15.0	8.95	8.73	8.52	8.31	8.09
24.0	18.0	8.95	8.73	8.52	8.31	8.09

NOTES:

- TC: Total Capacity (kW)
- Values mentioned in the table are based on the following conditions:
 - Pipe length: 5 m, Height difference: 0 m (Outdoor unit—Indoor unit)

● Mini duct type

Model: ARXG07KSLAP

Outdoor temperature		Indoor temperature (°CDB)				
		16.0	18.0	20.0	22.0	24.0
(°CDB)	(°CWB)	TC	TC	TC	TC	TC
-15.0	-16.0	1.82	1.78	1.74	1.69	1.65
-10.0	-11.0	2.12	2.07	2.02	1.97	1.92
-5.0	-7.0	2.23	2.18	2.13	2.07	2.02
0.0	-2.0	2.56	2.50	2.44	2.38	2.31
5.0	3.0	2.94	2.87	2.80	2.73	2.66
7.0	6.0	2.94	2.87	2.80	2.73	2.66
10.0	8.0	2.94	2.87	2.80	2.73	2.66
15.0	10.0	2.94	2.87	2.80	2.73	2.66
20.0	15.0	2.94	2.87	2.80	2.73	2.66
24.0	18.0	2.94	2.87	2.80	2.73	2.66

Model: ARXG09KSLAP

Outdoor temperature		Indoor temperature (°CDB)				
		16.0	18.0	20.0	22.0	24.0
(°CDB)	(°CWB)	TC	TC	TC	TC	TC
-15.0	-16.0	2.34	2.29	2.23	2.18	2.12
-10.0	-11.0	2.72	2.66	2.59	2.53	2.46
-5.0	-7.0	2.87	2.80	2.74	2.67	2.60
0.0	-2.0	3.29	3.21	3.13	3.05	2.98
5.0	3.0	3.78	3.69	3.60	3.51	3.42
7.0	6.0	3.78	3.69	3.60	3.51	3.42
10.0	8.0	3.78	3.69	3.60	3.51	3.42
15.0	10.0	3.78	3.69	3.60	3.51	3.42
20.0	15.0	3.78	3.69	3.60	3.51	3.42
24.0	18.0	3.78	3.69	3.60	3.51	3.42

Model: ARXG12KSLAP

Outdoor temperature		Indoor temperature (°CDB)				
		16.0	18.0	20.0	22.0	24.0
(°CDB)	(°CWB)	TC	TC	TC	TC	TC
-15.0	-16.0	3.12	3.05	2.98	2.90	2.83
-10.0	-11.0	3.63	3.54	3.46	3.37	3.28
-5.0	-7.0	3.83	3.74	3.65	3.56	3.47
0.0	-2.0	4.38	4.28	4.18	4.07	3.97
5.0	3.0	5.04	4.92	4.80	4.68	4.56
7.0	6.0	5.04	4.92	4.80	4.68	4.56
10.0	8.0	5.04	4.92	4.80	4.68	4.56
15.0	10.0	5.04	4.92	4.80	4.68	4.56
20.0	15.0	5.04	4.92	4.80	4.68	4.56
24.0	18.0	5.04	4.92	4.80	4.68	4.56

Model: ARXG14KSLAP

Outdoor temperature		Indoor temperature (°CDB)				
		16.0	18.0	20.0	22.0	24.0
(°CDB)	(°CWB)	TC	TC	TC	TC	TC
-15.0	-16.0	3.65	3.56	3.47	3.39	3.30
-10.0	-11.0	4.23	4.13	4.03	3.93	3.83
-5.0	-7.0	4.47	4.36	4.26	4.15	4.04
0.0	-2.0	5.12	4.99	4.87	4.75	4.63
5.0	3.0	5.88	5.74	5.60	5.46	5.32
7.0	6.0	5.88	5.74	5.60	5.46	5.32
10.0	8.0	5.88	5.74	5.60	5.46	5.32
15.0	10.0	5.88	5.74	5.60	5.46	5.32
20.0	15.0	5.88	5.74	5.60	5.46	5.32
24.0	18.0	5.88	5.74	5.60	5.46	5.32

Model: ARXG18KSLAP

Outdoor temperature		Indoor temperature (°CDB)				
		16.0	18.0	20.0	22.0	24.0
(°CDB)	(°CWB)	TC	TC	TC	TC	TC
-15.0	-16.0	4.39	4.29	4.19	4.08	3.98
-10.0	-11.0	5.10	4.98	4.86	4.74	4.62
-5.0	-7.0	5.39	5.26	5.13	5.00	4.87
0.0	-2.0	6.17	6.02	5.87	5.73	5.58
5.0	3.0	7.09	6.92	6.75	6.58	6.41
7.0	6.0	7.09	6.92	6.75	6.58	6.41
10.0	8.0	7.09	6.92	6.75	6.58	6.41
15.0	10.0	7.09	6.92	6.75	6.58	6.41
20.0	15.0	7.09	6.92	6.75	6.58	6.41
24.0	18.0	7.09	6.92	6.75	6.58	6.41

NOTES:

- TC: Total Capacity (kW)
- Values mentioned in the table are based on the following conditions:
 - Pipe length: 5 m, Height difference: 0 m [Outdoor unit—Indoor unit]

● Slim duct type

Model: ARXG07KLLAP

Outdoor temperature		Indoor temperature (°CDB)				
		16.0	18.0	20.0	22.0	24.0
(°CDB)	(°CWB)	TC	TC	TC	TC	TC
-15.0	-16.0	1.82	1.78	1.74	1.69	1.65
-10.0	-11.0	2.12	2.07	2.02	1.97	1.92
-5.0	-7.0	2.23	2.18	2.13	2.07	2.02
0.0	-2.0	2.56	2.50	2.44	2.38	2.31
5.0	3.0	2.94	2.87	2.80	2.73	2.66
7.0	6.0	2.94	2.87	2.80	2.73	2.66
10.0	8.0	2.94	2.87	2.80	2.73	2.66
15.0	10.0	2.94	2.87	2.80	2.73	2.66
20.0	15.0	2.94	2.87	2.80	2.73	2.66
24.0	18.0	2.94	2.87	2.80	2.73	2.66

Model: ARXG09KLLAP

Outdoor temperature		Indoor temperature (°CDB)				
		16.0	18.0	20.0	22.0	24.0
(°CDB)	(°CWB)	TC	TC	TC	TC	TC
-15.0	-16.0	2.34	2.29	2.23	2.18	2.12
-10.0	-11.0	2.72	2.66	2.59	2.53	2.46
-5.0	-7.0	2.87	2.80	2.74	2.67	2.60
0.0	-2.0	3.29	3.21	3.13	3.05	2.98
5.0	3.0	3.78	3.69	3.60	3.51	3.42
7.0	6.0	3.78	3.69	3.60	3.51	3.42
10.0	8.0	3.78	3.69	3.60	3.51	3.42
15.0	10.0	3.78	3.69	3.60	3.51	3.42
20.0	15.0	3.78	3.69	3.60	3.51	3.42
24.0	18.0	3.78	3.69	3.60	3.51	3.42

Model: ARXG12KLLAP

Outdoor temperature		Indoor temperature (°CDB)				
		16.0	18.0	20.0	22.0	24.0
(°CDB)	(°CWB)	TC	TC	TC	TC	TC
-15.0	-16.0	3.12	3.05	2.98	2.90	2.83
-10.0	-11.0	3.63	3.54	3.46	3.37	3.28
-5.0	-7.0	3.83	3.74	3.65	3.56	3.47
0.0	-2.0	4.38	4.28	4.18	4.07	3.97
5.0	3.0	5.04	4.92	4.80	4.68	4.56
7.0	6.0	5.04	4.92	4.80	4.68	4.56
10.0	8.0	5.04	4.92	4.80	4.68	4.56
15.0	10.0	5.04	4.92	4.80	4.68	4.56
20.0	15.0	5.04	4.92	4.80	4.68	4.56
24.0	18.0	5.04	4.92	4.80	4.68	4.56

Model: ARXG14KLLAP

Outdoor temperature		Indoor temperature (°CDB)				
		16.0	18.0	20.0	22.0	24.0
(°CDB)	(°CWB)	TC	TC	TC	TC	TC
-15.0	-16.0	3.65	3.56	3.47	3.39	3.30
-10.0	-11.0	4.23	4.13	4.03	3.93	3.83
-5.0	-7.0	4.47	4.36	4.26	4.15	4.04
0.0	-2.0	5.12	4.99	4.87	4.75	4.63
5.0	3.0	5.88	5.74	5.60	5.46	5.32
7.0	6.0	5.88	5.74	5.60	5.46	5.32
10.0	8.0	5.88	5.74	5.60	5.46	5.32
15.0	10.0	5.88	5.74	5.60	5.46	5.32
20.0	15.0	5.88	5.74	5.60	5.46	5.32
24.0	18.0	5.88	5.74	5.60	5.46	5.32

Model: ARXG18KLLAP

Outdoor temperature		Indoor temperature (°CDB)				
		16.0	18.0	20.0	22.0	24.0
(°CDB)	(°CWB)	TC	TC	TC	TC	TC
-15.0	-16.0	4.39	4.29	4.19	4.08	3.98
-10.0	-11.0	5.10	4.98	4.86	4.74	4.62
-5.0	-7.0	5.39	5.26	5.13	5.00	4.87
0.0	-2.0	6.17	6.02	5.87	5.73	5.58
5.0	3.0	7.09	6.92	6.75	6.58	6.41
7.0	6.0	7.09	6.92	6.75	6.58	6.41
10.0	8.0	7.09	6.92	6.75	6.58	6.41
15.0	10.0	7.09	6.92	6.75	6.58	6.41
20.0	15.0	7.09	6.92	6.75	6.58	6.41
24.0	18.0	7.09	6.92	6.75	6.58	6.41

NOTES:

- TC: Total Capacity (kW)
- Values mentioned in the table are based on the following conditions:
 - Pipe length: 5 m, Height difference: 0 m (Outdoor unit—Indoor unit)

● Medium static pressure duct type**Model: ARXG22KMLB**

Outdoor temperature		Indoor temperature (°CDB)				
		16.0	18.0	20.0	22.0	24.0
(°CDB)	(°CWB)	TC	TC	TC	TC	TC
-15.0	-16.0	5.55	5.41	5.28	5.15	5.02
-10.0	-11.0	6.44	6.29	6.13	5.98	5.83
-5.0	-7.0	6.80	6.64	6.48	6.31	6.15
0.0	-2.0	7.78	7.60	7.41	7.23	7.04
5.0	3.0	8.95	8.73	8.52	8.31	8.09
7.0	6.0	8.95	8.73	8.52	8.31	8.09
10.0	8.0	8.95	8.73	8.52	8.31	8.09
15.0	10.0	8.95	8.73	8.52	8.31	8.09
20.0	15.0	8.95	8.73	8.52	8.31	8.09
24.0	18.0	8.95	8.73	8.52	8.31	8.09

NOTES:

- TC: Total Capacity (kW)
- Values mentioned in the table are based on the following conditions:
 - Pipe length: 5 m, Height difference: 0 m (Outdoor unit—Indoor unit)

● Wall mounted type

Model: ASYG07KGTB

Outdoor temperature		Indoor temperature (°CDB)				
		16.0	18.0	20.0	22.0	24.0
(°CDB)	(°CWB)	TC	TC	TC	TC	TC
-15.0	-16.0	1.82	1.78	1.74	1.69	1.65
-10.0	-11.0	2.12	2.07	2.02	1.97	1.92
-5.0	-7.0	2.23	2.18	2.13	2.07	2.02
0.0	-2.0	2.56	2.50	2.44	2.38	2.31
5.0	3.0	2.94	2.87	2.80	2.73	2.66
7.0	6.0	2.94	2.87	2.80	2.73	2.66
10.0	8.0	2.94	2.87	2.80	2.73	2.66
15.0	10.0	2.94	2.87	2.80	2.73	2.66
20.0	15.0	2.94	2.87	2.80	2.73	2.66
24.0	18.0	2.94	2.87	2.80	2.73	2.66

Model: ASYG09KGTB

Outdoor temperature		Indoor temperature (°CDB)				
		16.0	18.0	20.0	22.0	24.0
(°CDB)	(°CWB)	TC	TC	TC	TC	TC
-15.0	-16.0	2.34	2.29	2.23	2.18	2.12
-10.0	-11.0	2.72	2.66	2.59	2.53	2.46
-5.0	-7.0	2.87	2.80	2.74	2.67	2.60
0.0	-2.0	3.29	3.21	3.13	3.05	2.98
5.0	3.0	3.78	3.69	3.60	3.51	3.42
7.0	6.0	3.78	3.69	3.60	3.51	3.42
10.0	8.0	3.78	3.69	3.60	3.51	3.42
15.0	10.0	3.78	3.69	3.60	3.51	3.42
20.0	15.0	3.78	3.69	3.60	3.51	3.42
24.0	18.0	3.78	3.69	3.60	3.51	3.42

Model: ASYG12KGTB

Outdoor temperature		Indoor temperature (°CDB)				
		16.0	18.0	20.0	22.0	24.0
(°CDB)	(°CWB)	TC	TC	TC	TC	TC
-15.0	-16.0	3.12	3.05	2.98	2.90	2.83
-10.0	-11.0	3.63	3.54	3.46	3.37	3.28
-5.0	-7.0	3.83	3.74	3.65	3.56	3.47
0.0	-2.0	4.38	4.28	4.18	4.07	3.97
5.0	3.0	5.04	4.92	4.80	4.68	4.56
7.0	6.0	5.04	4.92	4.80	4.68	4.56
10.0	8.0	5.04	4.92	4.80	4.68	4.56
15.0	10.0	5.04	4.92	4.80	4.68	4.56
20.0	15.0	5.04	4.92	4.80	4.68	4.56
24.0	18.0	5.04	4.92	4.80	4.68	4.56

Model: ASYG14KGTB

Outdoor temperature		Indoor temperature (°CDB)				
		16.0	18.0	20.0	22.0	24.0
(°CDB)	(°CWB)	TC	TC	TC	TC	TC
-15.0	-16.0	3.65	3.56	3.47	3.39	3.30
-10.0	-11.0	4.23	4.13	4.03	3.93	3.83
-5.0	-7.0	4.47	4.36	4.26	4.15	4.04
0.0	-2.0	5.12	4.99	4.87	4.75	4.63
5.0	3.0	5.88	5.74	5.60	5.46	5.32
7.0	6.0	5.88	5.74	5.60	5.46	5.32
10.0	8.0	5.88	5.74	5.60	5.46	5.32
15.0	10.0	5.88	5.74	5.60	5.46	5.32
20.0	15.0	5.88	5.74	5.60	5.46	5.32
24.0	18.0	5.88	5.74	5.60	5.46	5.32

Model: ASYG18KMTB

Outdoor temperature		Indoor temperature (°CDB)				
		16.0	18.0	20.0	22.0	24.0
(°CDB)	(°CWB)	TC	TC	TC	TC	TC
-15.0	-16.0	4.39	4.29	4.19	4.08	3.98
-10.0	-11.0	5.10	4.98	4.86	4.74	4.62
-5.0	-7.0	5.39	5.26	5.13	5.00	4.87
0.0	-2.0	6.17	6.02	5.87	5.73	5.58
5.0	3.0	7.09	6.92	6.75	6.58	6.41
7.0	6.0	7.09	6.92	6.75	6.58	6.41
10.0	8.0	7.09	6.92	6.75	6.58	6.41
15.0	10.0	7.09	6.92	6.75	6.58	6.41
20.0	15.0	7.09	6.92	6.75	6.58	6.41
24.0	18.0	7.09	6.92	6.75	6.58	6.41

Model: ASYG22KMTB

Outdoor temperature		Indoor temperature (°CDB)				
		16.0	18.0	20.0	22.0	24.0
(°CDB)	(°CWB)	TC	TC	TC	TC	TC
-15.0	-16.0	5.55	5.41	5.28	5.15	5.02
-10.0	-11.0	6.44	6.29	6.13	5.98	5.83
-5.0	-7.0	6.80	6.64	6.48	6.31	6.15
0.0	-2.0	7.78	7.60	7.41	7.23	7.04
5.0	3.0	8.95	8.73	8.52	8.31	8.09
7.0	6.0	8.95	8.73	8.52	8.31	8.09
10.0	8.0	8.95	8.73	8.52	8.31	8.09
15.0	10.0	8.95	8.73	8.52	8.31	8.09
20.0	15.0	8.95	8.73	8.52	8.31	8.09
24.0	18.0	8.95	8.73	8.52	8.31	8.09

Model: ASYG24KMTB

Outdoor temperature		Indoor temperature (°CDB)				
		16.0	18.0	20.0	22.0	24.0
(°CDB)	(°CWB)	TC	TC	TC	TC	TC
-15.0	-16.0	6.05	5.90	5.76	5.62	5.47
-10.0	-11.0	7.02	6.86	6.69	6.52	6.35
-5.0	-7.0	7.41	7.24	7.06	6.88	6.71
0.0	-2.0	8.49	8.28	8.08	7.88	7.68
5.0	3.0	9.75	9.52	9.29	9.06	8.83
7.0	6.0	9.75	9.52	9.29	9.06	8.83
10.0	8.0	9.75	9.52	9.29	9.06	8.83
15.0	10.0	9.75	9.52	9.29	9.06	8.83
20.0	15.0	9.75	9.52	9.29	9.06	8.83
24.0	18.0	9.75	9.52	9.29	9.06	8.83

Model: ASYG07KMTB

Outdoor temperature		Indoor temperature (°CDB)				
		16.0	18.0	20.0	22.0	24.0
(°CDB)	(°CWB)	TC	TC	TC	TC	TC
-15.0	-16.0	1.82	1.78	1.74	1.69	1.65
-10.0	-11.0	2.12	2.07	2.02	1.97	1.92
-5.0	-7.0	2.23	2.18	2.13	2.07	2.02
0.0	-2.0	2.56	2.50	2.44	2.38	2.31
5.0	3.0	2.94	2.87	2.80	2.73	2.66
7.0	6.0	2.94	2.87	2.80	2.73	2.66
10.0	8.0	2.94	2.87	2.80	2.73	2.66
15.0	10.0	2.94	2.87	2.80	2.73	2.66
20.0	15.0	2.94	2.87	2.80	2.73	2.66
24.0	18.0	2.94	2.87	2.80	2.73	2.66

Model: ASYG09KMTB

Outdoor temperature		Indoor temperature (°CDB)				
		16.0	18.0	20.0	22.0	24.0
(°CDB)	(°CWB)	TC	TC	TC	TC	TC
-15.0	-16.0	2.34	2.29	2.23	2.18	2.12
-10.0	-11.0	2.72	2.66	2.59	2.53	2.46
-5.0	-7.0	2.87	2.80	2.74	2.67	2.60
0.0	-2.0	3.29	3.21	3.13	3.05	2.98
5.0	3.0	3.78	3.69	3.60	3.51	3.42
7.0	6.0	3.78	3.69	3.60	3.51	3.42
10.0	8.0	3.78	3.69	3.60	3.51	3.42
15.0	10.0	3.78	3.69	3.60	3.51	3.42
20.0	15.0	3.78	3.69	3.60	3.51	3.42
24.0	18.0	3.78	3.69	3.60	3.51	3.42

Model: ASYG12KMTB

Outdoor temperature		Indoor temperature (°CDB)				
		16.0	18.0	20.0	22.0	24.0
(°CDB)	(°CWB)	TC	TC	TC	TC	TC
-15.0	-16.0	3.12	3.05	2.98	2.90	2.83
-10.0	-11.0	3.63	3.54	3.46	3.37	3.28
-5.0	-7.0	3.83	3.74	3.65	3.56	3.47
0.0	-2.0	4.38	4.28	4.18	4.07	3.97
5.0	3.0	5.04	4.92	4.80	4.68	4.56
7.0	6.0	5.04	4.92	4.80	4.68	4.56
10.0	8.0	5.04	4.92	4.80	4.68	4.56
15.0	10.0	5.04	4.92	4.80	4.68	4.56
20.0	15.0	5.04	4.92	4.80	4.68	4.56
24.0	18.0	5.04	4.92	4.80	4.68	4.56

Model: ASYG14KMTB

Outdoor temperature		Indoor temperature (°CDB)				
		16.0	18.0	20.0	22.0	24.0
(°CDB)	(°CWB)	TC	TC	TC	TC	TC
-15.0	-16.0	3.65	3.56	3.47	3.39	3.30
-10.0	-11.0	4.23	4.13	4.03	3.93	3.83
-5.0	-7.0	4.47	4.36	4.26	4.15	4.04
0.0	-2.0	5.12	4.99	4.87	4.75	4.63
5.0	3.0	5.88	5.74	5.60	5.46	5.32
7.0	6.0	5.88	5.74	5.60	5.46	5.32
10.0	8.0	5.88	5.74	5.60	5.46	5.32
15.0	10.0	5.88	5.74	5.60	5.46	5.32
20.0	15.0	5.88	5.74	5.60	5.46	5.32
24.0	18.0	5.88	5.74	5.60	5.46	5.32

Model: ASYG07KMCC

Outdoor temperature		Indoor temperature (°CDB)				
		16.0	18.0	20.0	22.0	24.0
(°CDB)	(°CWB)	TC	TC	TC	TC	TC
-15.0	-16.0	1.82	1.78	1.74	1.69	1.65
-10.0	-11.0	2.12	2.07	2.02	1.97	1.92
-5.0	-7.0	2.23	2.18	2.13	2.07	2.02
0.0	-2.0	2.56	2.50	2.44	2.38	2.31
5.0	3.0	2.94	2.87	2.80	2.73	2.66
7.0	6.0	2.94	2.87	2.80	2.73	2.66
10.0	8.0	2.94	2.87	2.80	2.73	2.66
15.0	10.0	2.94	2.87	2.80	2.73	2.66
20.0	15.0	2.94	2.87	2.80	2.73	2.66
24.0	18.0	2.94	2.87	2.80	2.73	2.66

Model: ASYG09KMCC

Outdoor temperature		Indoor temperature (°CDB)				
		16.0	18.0	20.0	22.0	24.0
(°CDB)	(°CWB)	TC	TC	TC	TC	TC
-15.0	-16.0	2.34	2.29	2.23	2.18	2.12
-10.0	-11.0	2.72	2.66	2.59	2.53	2.46
-5.0	-7.0	2.87	2.80	2.74	2.67	2.60
0.0	-2.0	3.29	3.21	3.13	3.05	2.98
5.0	3.0	3.78	3.69	3.60	3.51	3.42
7.0	6.0	3.78	3.69	3.60	3.51	3.42
10.0	8.0	3.78	3.69	3.60	3.51	3.42
15.0	10.0	3.78	3.69	3.60	3.51	3.42
20.0	15.0	3.78	3.69	3.60	3.51	3.42
24.0	18.0	3.78	3.69	3.60	3.51	3.42

Model: ASYG12KMCC

Outdoor temperature		Indoor temperature (°CDB)				
		16.0	18.0	20.0	22.0	24.0
(°CDB)	(°CWB)	TC	TC	TC	TC	TC
-15.0	-16.0	3.12	3.05	2.98	2.90	2.83
-10.0	-11.0	3.63	3.54	3.46	3.37	3.28
-5.0	-7.0	3.83	3.74	3.65	3.56	3.47
0.0	-2.0	4.38	4.28	4.18	4.07	3.97
5.0	3.0	5.04	4.92	4.80	4.68	4.56
7.0	6.0	5.04	4.92	4.80	4.68	4.56
10.0	8.0	5.04	4.92	4.80	4.68	4.56
15.0	10.0	5.04	4.92	4.80	4.68	4.56
20.0	15.0	5.04	4.92	4.80	4.68	4.56
24.0	18.0	5.04	4.92	4.80	4.68	4.56

Model: ASYG14KMCC

Outdoor temperature		Indoor temperature (°CDB)				
		16.0	18.0	20.0	22.0	24.0
(°CDB)	(°CWB)	TC	TC	TC	TC	TC
-15.0	-16.0	3.65	3.56	3.47	3.39	3.30
-10.0	-11.0	4.23	4.13	4.03	3.93	3.83
-5.0	-7.0	4.47	4.36	4.26	4.15	4.04
0.0	-2.0	5.12	4.99	4.87	4.75	4.63
5.0	3.0	5.88	5.74	5.60	5.46	5.32
7.0	6.0	5.88	5.74	5.60	5.46	5.32
10.0	8.0	5.88	5.74	5.60	5.46	5.32
15.0	10.0	5.88	5.74	5.60	5.46	5.32
20.0	15.0	5.88	5.74	5.60	5.46	5.32
24.0	18.0	5.88	5.74	5.60	5.46	5.32

Model: ASYG07KETA, ASYG07KETA-B

Outdoor temperature		Indoor temperature (°CDB)				
		16.0	18.0	20.0	22.0	24.0
(°CDB)	(°CWB)	TC	TC	TC	TC	TC
-15.0	-16.0	1.82	1.78	1.74	1.69	1.65
-10.0	-11.0	2.12	2.07	2.02	1.97	1.92
-5.0	-7.0	2.23	2.18	2.13	2.07	2.02
0.0	-2.0	2.56	2.50	2.44	2.38	2.31
5.0	3.0	2.94	2.87	2.80	2.73	2.66
7.0	6.0	2.94	2.87	2.80	2.73	2.66
10.0	8.0	2.94	2.87	2.80	2.73	2.66
15.0	10.0	2.94	2.87	2.80	2.73	2.66
20.0	15.0	2.94	2.87	2.80	2.73	2.66
24.0	18.0	2.94	2.87	2.80	2.73	2.66

Model: ASYG09KETA, ASYG09KETA-B

Outdoor temperature		Indoor temperature (°CDB)				
		16.0	18.0	20.0	22.0	24.0
(°CDB)	(°CWB)	TC	TC	TC	TC	TC
-15.0	-16.0	2.34	2.29	2.23	2.18	2.12
-10.0	-11.0	2.72	2.66	2.59	2.53	2.46
-5.0	-7.0	2.87	2.80	2.74	2.67	2.60
0.0	-2.0	3.29	3.21	3.13	3.05	2.98
5.0	3.0	3.78	3.69	3.60	3.51	3.42
7.0	6.0	3.78	3.69	3.60	3.51	3.42
10.0	8.0	3.78	3.69	3.60	3.51	3.42
15.0	10.0	3.78	3.69	3.60	3.51	3.42
20.0	15.0	3.78	3.69	3.60	3.51	3.42
24.0	18.0	3.78	3.69	3.60	3.51	3.42

Model: ASYG12KETA, ASYG12KETA-B

Outdoor temperature		Indoor temperature (°CDB)				
		16.0	18.0	20.0	22.0	24.0
(°CDB)	(°CWB)	TC	TC	TC	TC	TC
-15.0	-16.0	3.12	3.05	2.98	2.90	2.83
-10.0	-11.0	3.63	3.54	3.46	3.37	3.28
-5.0	-7.0	3.83	3.74	3.65	3.56	3.47
0.0	-2.0	4.38	4.28	4.18	4.07	3.97
5.0	3.0	5.04	4.92	4.80	4.68	4.56
7.0	6.0	5.04	4.92	4.80	4.68	4.56
10.0	8.0	5.04	4.92	4.80	4.68	4.56
15.0	10.0	5.04	4.92	4.80	4.68	4.56
20.0	15.0	5.04	4.92	4.80	4.68	4.56
24.0	18.0	5.04	4.92	4.80	4.68	4.56

Model: ASYG14KETA, ASYG14KETA-B

Outdoor temperature		Indoor temperature (°CDB)				
		16.0	18.0	20.0	22.0	24.0
(°CDB)	(°CWB)	TC	TC	TC	TC	TC
-15.0	-16.0	3.65	3.56	3.47	3.39	3.30
-10.0	-11.0	4.23	4.13	4.03	3.93	3.83
-5.0	-7.0	4.47	4.36	4.26	4.15	4.04
0.0	-2.0	5.12	4.99	4.87	4.75	4.63
5.0	3.0	5.88	5.74	5.60	5.46	5.32
7.0	6.0	5.88	5.74	5.60	5.46	5.32
10.0	8.0	5.88	5.74	5.60	5.46	5.32
15.0	10.0	5.88	5.74	5.60	5.46	5.32
20.0	15.0	5.88	5.74	5.60	5.46	5.32
24.0	18.0	5.88	5.74	5.60	5.46	5.32

NOTES:

- TC: Total Capacity (kW)
- Values mentioned in the table are based on the following conditions:
 - Pipe length: 5 m, Height difference: 0 m (Outdoor unit—Indoor unit)

● Ceiling type

Model: ABYG18KRTA

Outdoor temperature		Indoor temperature (°CDB)				
		16.0	18.0	20.0	22.0	24.0
(°CDB)	(°CWB)	TC	TC	TC	TC	TC
-15.0	-16.0	4.39	4.29	4.19	4.08	3.98
-10.0	-11.0	5.10	4.98	4.86	4.74	4.62
-5.0	-7.0	5.39	5.26	5.13	5.00	4.87
0.0	-2.0	6.17	6.02	5.87	5.73	5.58
5.0	3.0	7.09	6.92	6.75	6.58	6.41
7.0	6.0	7.09	6.92	6.75	6.58	6.41
10.0	8.0	7.09	6.92	6.75	6.58	6.41
15.0	10.0	7.09	6.92	6.75	6.58	6.41
20.0	15.0	7.09	6.92	6.75	6.58	6.41
24.0	18.0	7.09	6.92	6.75	6.58	6.41

Model: ABYG22KRTA

Outdoor temperature		Indoor temperature (°CDB)				
		16.0	18.0	20.0	22.0	24.0
(°CDB)	(°CWB)	TC	TC	TC	TC	TC
-15.0	-16.0	5.55	5.41	5.28	5.15	5.02
-10.0	-11.0	6.44	6.29	6.13	5.98	5.83
-5.0	-7.0	6.80	6.64	6.48	6.31	6.15
0.0	-2.0	7.78	7.60	7.41	7.23	7.04
5.0	3.0	8.95	8.73	8.52	8.31	8.09
7.0	6.0	8.95	8.73	8.52	8.31	8.09
10.0	8.0	8.95	8.73	8.52	8.31	8.09
15.0	10.0	8.95	8.73	8.52	8.31	8.09
20.0	15.0	8.95	8.73	8.52	8.31	8.09
24.0	18.0	8.95	8.73	8.52	8.31	8.09

NOTES:

- TC: Total Capacity (kW)
- Values mentioned in the table are based on the following conditions:
 - Pipe length: 5 m, Height difference: 0 m (Outdoor unit—Indoor unit)

● Floor type

Model: AGYG09KVCA

Outdoor temperature		Indoor temperature (°CDB)				
		16.0	18.0	20.0	22.0	24.0
(°CDB)	(°CWB)	TC	TC	TC	TC	TC
-15.0	-16.0	2.34	2.29	2.23	2.18	2.12
-10.0	-11.0	2.72	2.66	2.59	2.53	2.46
-5.0	-7.0	2.87	2.80	2.74	2.67	2.60
0.0	-2.0	3.29	3.21	3.13	3.05	2.98
5.0	3.0	3.78	3.69	3.60	3.51	3.42
7.0	6.0	3.78	3.69	3.60	3.51	3.42
10.0	8.0	3.78	3.69	3.60	3.51	3.42
15.0	10.0	3.78	3.69	3.60	3.51	3.42
20.0	15.0	3.78	3.69	3.60	3.51	3.42
24.0	18.0	3.78	3.69	3.60	3.51	3.42

Model: AGYG12KVCA

Outdoor temperature		Indoor temperature (°CDB)				
		16.0	18.0	20.0	22.0	24.0
(°CDB)	(°CWB)	TC	TC	TC	TC	TC
-15.0	-16.0	3.12	3.05	2.98	2.90	2.83
-10.0	-11.0	3.63	3.54	3.46	3.37	3.28
-5.0	-7.0	3.83	3.74	3.65	3.56	3.47
0.0	-2.0	4.38	4.28	4.18	4.07	3.97
5.0	3.0	5.04	4.92	4.80	4.68	4.56
7.0	6.0	5.04	4.92	4.80	4.68	4.56
10.0	8.0	5.04	4.92	4.80	4.68	4.56
15.0	10.0	5.04	4.92	4.80	4.68	4.56
20.0	15.0	5.04	4.92	4.80	4.68	4.56
24.0	18.0	5.04	4.92	4.80	4.68	4.56

Model: AGYG14KVCA

Outdoor temperature		Indoor temperature (°CDB)				
		16.0	18.0	20.0	22.0	24.0
(°CDB)	(°CWB)	TC	TC	TC	TC	TC
-15.0	-16.0	3.65	3.56	3.47	3.39	3.30
-10.0	-11.0	4.23	4.13	4.03	3.93	3.83
-5.0	-7.0	4.47	4.36	4.26	4.15	4.04
0.0	-2.0	5.12	4.99	4.87	4.75	4.63
5.0	3.0	5.88	5.74	5.60	5.46	5.32
7.0	6.0	5.88	5.74	5.60	5.46	5.32
10.0	8.0	5.88	5.74	5.60	5.46	5.32
15.0	10.0	5.88	5.74	5.60	5.46	5.32
20.0	15.0	5.88	5.74	5.60	5.46	5.32
24.0	18.0	5.88	5.74	5.60	5.46	5.32

NOTES:

- TC: Total Capacity (kW)
- Values mentioned in the table are based on the following conditions:
 - Pipe length: 5 m, Height difference: 0 m (Outdoor unit—Indoor unit)

7. Capacity compensation rate for pipe length and height difference

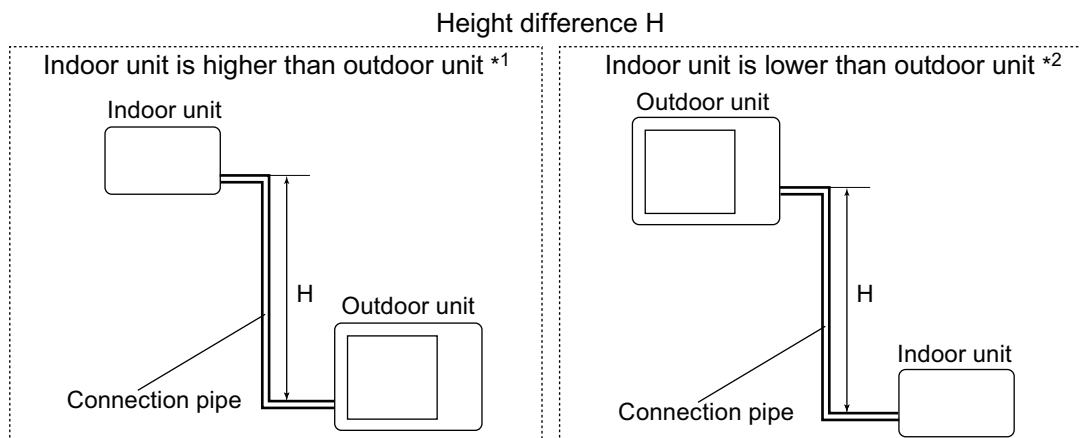

7-1. Model: AOYG36KBTA5

NOTE: Values mentioned in the table are calculated based on the maximum capacity.

■ Indoor unit: 7,000 Btu/h

Cooling		Pipe length						
		m	2.5	5	10	15	20	25
Height difference H (m)	Indoor unit is higher than outdoor unit *1	15	—	—	—	0.955	0.941	0.927
		10	—	—	0.976	0.962	0.949	0.935
		5	—	0.992	0.984	0.970	0.956	0.942
		2.5	0.996	0.996	0.988	0.974	0.960	0.946
	Indoor unit is lower than outdoor unit *2	0	1.000	1.000	0.992	0.978	0.964	0.950
		-2.5	1.000	1.000	0.992	0.978	0.964	0.950
		-5	—	1.000	0.992	0.978	0.964	0.950
		-10	—	—	0.992	0.978	0.964	0.950
		-15	—	—	—	0.978	0.964	0.950

Heating		Pipe length						
		m	2.5	5	10	15	20	25
Height difference H (m)	Indoor unit is higher than outdoor unit *1	15	—	—	—	0.976	0.957	0.938
		10	—	—	0.991	0.976	0.957	0.938
		5	—	1.000	0.991	0.976	0.957	0.938
		2.5	1.000	1.000	0.991	0.976	0.957	0.938
	Indoor unit is lower than outdoor unit *2	0	1.000	1.000	0.991	0.976	0.957	0.938
		-2.5	0.998	0.997	0.989	0.974	0.955	0.936
		-5	—	0.995	0.986	0.971	0.952	0.933
		-10	—	—	0.981	0.966	0.947	0.929
		-15	—	—	—	0.961	0.943	0.924

■ Indoor unit: 9,000 Btu/h

Cooling		Pipe length						
		m	2.5	5	10	15	20	25
Height difference H (m)	Indoor unit is higher than outdoor unit *1	15	—	—	—	0.956	0.942	0.928
		10	—	—	0.977	0.963	0.950	0.936
		5	—	0.992	0.985	0.971	0.957	0.943
		2.5	0.996	0.996	0.989	0.975	0.961	0.947
	Indoor unit is lower than outdoor unit *2	0	1.000	1.000	0.993	0.979	0.965	0.951
		-2.5	1.000	1.000	0.993	0.979	0.965	0.951
		-5	—	1.000	0.993	0.979	0.965	0.951
		-10	—	—	0.993	0.979	0.965	0.951
		-15	—	—	—	0.979	0.965	0.951

Heating		Pipe length						
		m	2.5	5	10	15	20	25
Height difference H (m)	Indoor unit is higher than outdoor unit *1	15	—	—	—	0.977	0.958	0.939
		10	—	—	0.993	0.977	0.958	0.939
		5	—	1.000	0.993	0.977	0.958	0.939
		2.5	1.000	1.000	0.993	0.977	0.958	0.939
	Indoor unit is lower than outdoor unit *2	0	1.000	1.000	0.993	0.977	0.958	0.939
		-2.5	0.998	0.997	0.991	0.975	0.956	0.937
		-5	—	0.995	0.988	0.972	0.954	0.934
		-10	—	—	0.983	0.967	0.949	0.930
		-15	—	—	—	0.962	0.944	0.925

■ Indoor unit: 12,000 Btu/h

Cooling		Pipe length						
		m	2.5	5	10	15	20	25
Height difference H (m)	Indoor unit is higher than outdoor unit *1	15	—	—	—	0.937	0.912	0.888
		10	—	—	0.970	0.944	0.919	0.896
		5	—	0.992	0.978	0.952	0.927	0.903
		2.5	0.996	0.996	0.982	0.956	0.930	0.907
	Indoor unit is lower than outdoor unit *2	0	1.000	1.000	0.986	0.960	0.934	0.910
		-2.5	1.000	1.000	0.986	0.960	0.934	0.910
		-5	—	1.000	0.986	0.960	0.934	0.910
		-10	—	—	0.986	0.960	0.934	0.910
		-15	—	—	—	0.960	0.934	0.910

Heating		Pipe length						
		m	2.5	5	10	15	20	25
Height difference H (m)	Indoor unit is higher than outdoor unit *1	15	—	—	—	0.977	0.958	0.938
		10	—	—	0.993	0.977	0.958	0.938
		5	—	1.000	0.993	0.977	0.958	0.938
		2.5	1.000	1.000	0.993	0.977	0.958	0.938
	Indoor unit is lower than outdoor unit *2	0	1.000	1.000	0.993	0.977	0.958	0.938
		-2.5	0.998	0.997	0.991	0.975	0.956	0.936
		-5	—	0.995	0.988	0.972	0.953	0.933
		-10	—	—	0.983	0.967	0.949	0.929
		-15	—	—	—	0.962	0.944	0.924

■ Indoor unit: 14,000 Btu/h

Cooling		Pipe length						
		m	2.5	5	10	15	20	25
Height difference H (m)	Indoor unit is higher than outdoor unit *1	15	—	—	—	0.955	0.937	0.922
		10	—	—	0.974	0.962	0.945	0.930
		5	—	0.992	0.982	0.970	0.952	0.937
		2.5	0.996	0.996	0.986	0.974	0.956	0.941
	Indoor unit is lower than outdoor unit *2	0	1.000	1.000	0.990	0.978	0.960	0.945
		-2.5	1.000	1.000	0.990	0.978	0.960	0.945
		-5	—	1.000	0.990	0.978	0.960	0.945
		-10	—	—	0.990	0.978	0.960	0.945
		-15	—	—	—	0.978	0.960	0.945

Heating		Pipe length						
		m	2.5	5	10	15	20	25
Height difference H (m)	Indoor unit is higher than outdoor unit *1	15	—	—	—	0.972	0.945	0.919
		10	—	—	0.992	0.972	0.945	0.919
		5	—	1.000	0.992	0.972	0.945	0.919
		2.5	1.000	1.000	0.992	0.972	0.945	0.919
	Indoor unit is lower than outdoor unit *2	0	1.000	1.000	0.992	0.972	0.945	0.919
		-2.5	0.998	0.997	0.990	0.970	0.943	0.917
		-5	—	0.995	0.987	0.967	0.940	0.914
		-10	—	—	0.982	0.962	0.935	0.910
		-15	—	—	—	0.957	0.930	0.905

■ Indoor unit: 18,000 Btu/h

Cooling		Pipe length						
		m	2.5	5	10	15	20	25
Height difference H (m)	Indoor unit is higher than outdoor unit *1	15	—	—	—	0.968	0.961	0.954
		10	—	—	0.982	0.976	0.969	0.962
		5	—	0.992	0.990	0.984	0.977	0.970
		2.5	0.996	0.996	0.994	0.988	0.981	0.974
	Indoor unit is lower than outdoor unit *2	0	1.000	1.000	0.998	0.992	0.985	0.978
		-2.5	1.000	1.000	0.998	0.992	0.985	0.978
		-5	—	1.000	0.998	0.992	0.985	0.978
		-10	—	—	0.998	0.992	0.985	0.978
		-15	—	—	—	0.992	0.985	0.978

Heating		Pipe length						
		m	2.5	5	10	15	20	25
Height difference H (m)	Indoor unit is higher than outdoor unit *1	15	—	—	—	0.967	0.943	0.917
		10	—	—	0.990	0.967	0.943	0.917
		5	—	1.000	0.990	0.967	0.943	0.917
		2.5	1.000	1.000	0.990	0.967	0.943	0.917
	Indoor unit is lower than outdoor unit *2	0	1.000	1.000	0.990	0.967	0.943	0.917
		-2.5	0.998	0.997	0.988	0.965	0.941	0.915
		-5	—	0.995	0.985	0.962	0.938	0.912
		-10	—	—	0.980	0.958	0.933	0.908
		-15	—	—	—	0.953	0.929	0.903

■ Indoor unit: 22,000 Btu/h

Cooling		Pipe length						
		m	2.5	5	10	15	20	25
Height difference H (m)	Indoor unit is higher than outdoor unit *1	15	—	—	—	0.978	0.969	0.953
		10	—	—	0.986	0.986	0.977	0.961
		5	—	0.992	0.994	0.994	0.984	0.968
		2.5	0.996	0.996	0.998	0.998	0.988	0.972
	Indoor unit is lower than outdoor unit *2	0	1.000	1.000	1.002	1.002	0.992	0.976
		-2.5	1.000	1.000	1.002	1.002	0.992	0.976
		-5	—	1.000	1.002	1.002	0.992	0.976
		-10	—	—	1.002	1.002	0.992	0.976
		-15	—	—	—	1.002	0.992	0.976

Heating		Pipe length						
		m	2.5	5	10	15	20	25
Height difference H (m)	Indoor unit is higher than outdoor unit *1	15	—	—	—	0.964	0.939	0.913
		10	—	—	0.988	0.964	0.939	0.913
		5	—	1.000	0.988	0.964	0.939	0.913
		2.5	1.000	1.000	0.988	0.964	0.939	0.913
	Indoor unit is lower than outdoor unit *2	0	1.000	1.000	0.988	0.964	0.939	0.913
		-2.5	0.998	0.997	0.986	0.962	0.937	0.911
		-5	—	0.995	0.983	0.959	0.934	0.909
		-10	—	—	0.978	0.954	0.929	0.904
		-15	—	—	—	0.949	0.925	0.899

■ Indoor unit: 24,000 Btu/h

Cooling		Pipe length						
		m	2.5	5	10	15	20	25
Height difference H (m)	Indoor unit is higher than outdoor unit *1	15	—	—	—	0.978	0.969	0.953
		10	—	—	0.986	0.986	0.977	0.961
		5	—	0.992	0.994	0.994	0.984	0.968
		2.5	0.996	0.996	0.998	0.998	0.988	0.972
	Indoor unit is lower than outdoor unit *2	0	1.000	1.000	1.002	1.002	0.992	0.976
		-2.5	1.000	1.000	1.002	1.002	0.992	0.976
		-5	—	1.000	1.002	1.002	0.992	0.976
		-10	—	—	1.002	1.002	0.992	0.976
		-15	—	—	—	1.002	0.992	0.976

Heating		Pipe length						
		m	2.5	5	10	15	20	25
Height difference H (m)	Indoor unit is higher than outdoor unit *1	15	—	—	—	0.964	0.939	0.913
		10	—	—	0.988	0.964	0.939	0.913
		5	—	1.000	0.988	0.964	0.939	0.913
		2.5	1.000	1.000	0.988	0.964	0.939	0.913
	Indoor unit is lower than outdoor unit *2	0	1.000	1.000	0.988	0.964	0.939	0.913
		-2.5	0.998	0.997	0.986	0.962	0.937	0.911
		-5	—	0.995	0.983	0.959	0.934	0.909
		-10	—	—	0.978	0.954	0.929	0.904
		-15	—	—	—	0.949	0.925	0.899

8. Additional charge calculation

8-1. Model: AOYG36KBTA5

Refrigerant type		R32
Refrigerant amount	g	2,500

Refrigerant charge							20 g/m
Total pipe length	m	40 or less	50	60	70	75 (Max.)	
Additional charge amount	g	0	200	400	600	700	

9. Airflow

9-1. Model: AOYG36KBTA5

● Cooling

m ³ /h	2,450
l/s	708
CFM	1,501

● Heating

m ³ /h	2,900
l/s	833
CFM	1,766

10. Operation noise (sound pressure)

10-1. Noise level curve

Model: AOYG36KBTA5

● Cooling

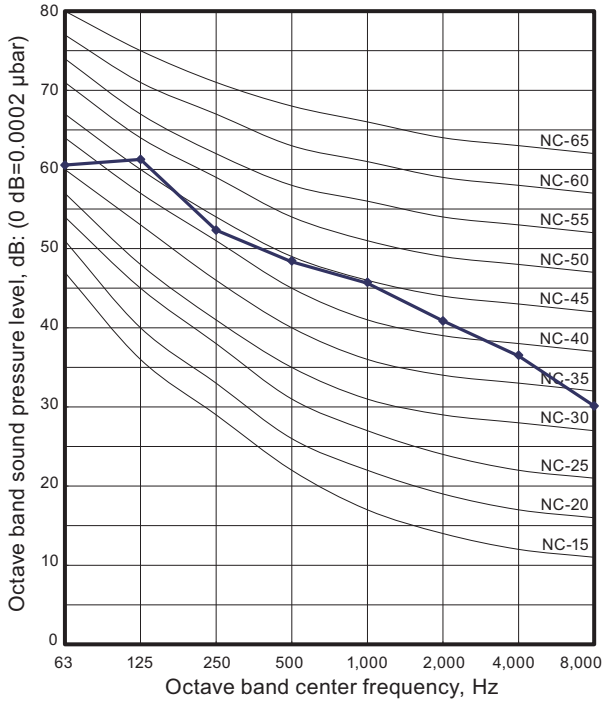

● Heating

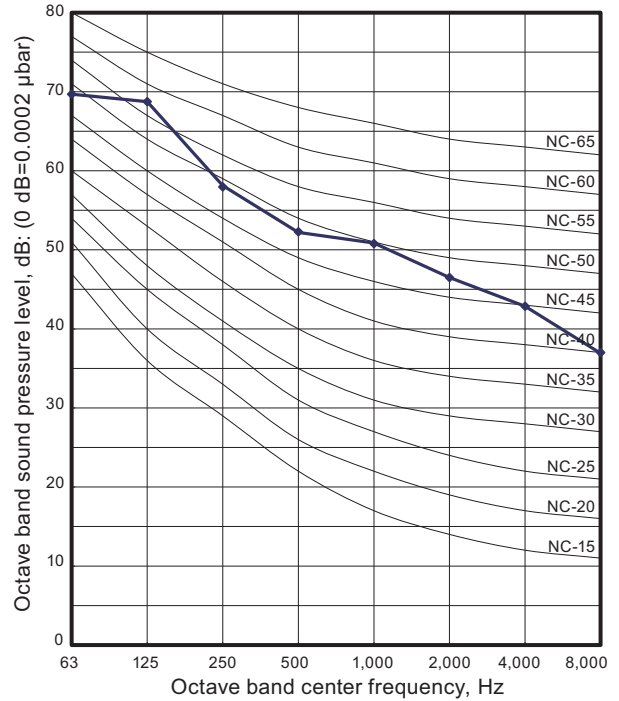

OUTDOOR UNIT
AOYG36KBTA5

OUTDOOR UNIT
AOYG36KBTA5

10-2. Sound level check point

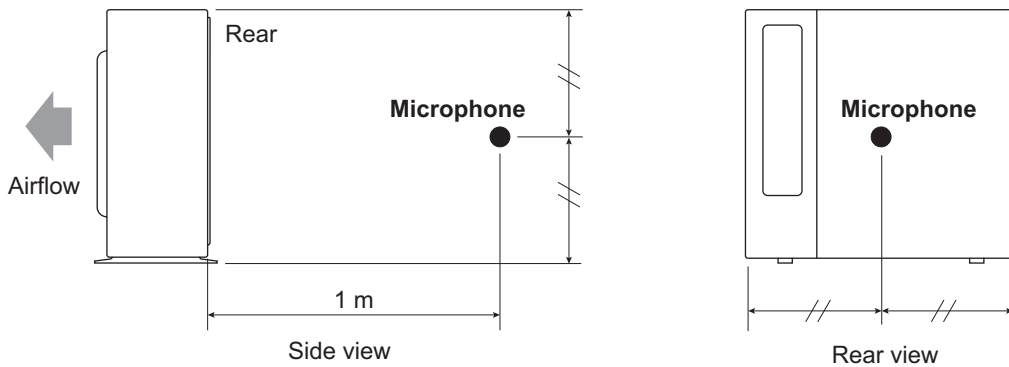

NOTE: Detailed shape of the actual outdoor unit might be slightly different from the one illustrated above.

11. Electrical characteristics

Model name			AOYG36KBTA5	
Power supply	Voltage	V	230 ~	
	Frequency	Hz	50	
Maximum operating current *1		A	20.0	
Starting current		A	11.1	
Wiring spec. *2	Main fuse (Circuit breaker) current		A	
	Power cable		mm ²	
	Connection cable *3	Cross-sectional area		1.5
		Limited wiring length	m	26

*1: Maximum operating current is the total current of the indoor unit and the outdoor unit.

*2: Selected sample based on Japan Electrotechnical Standards and Codes Committee E0005. As the regulations of wire size and circuit breaker differ in each country or region, select appropriate devices complied to the regional standard.

*3: This is the wiring length in case voltage descent is less than 2%. When the wiring length becomes longer, select the wiring of a more larger diameter.

12. Safety devices

Type of protection	Protection form		Model
			AOYG36KBTA5
Circuit protection	Current fuse (Main PCB)		250 V, 5 A 250 V, 20 A 250 V, 3.15 A
Fan motor protection	Thermal protector	Activate	125 ±10 °C Fan motor stop
		Reset	120 ±10 °C Fan motor restart
Compressor protection	Temperature thermistor (Discharge temp.)	Activate	110 °C Compressor stop
		Reset	After 7 minutes Compressor restart
	Temperature thermistor (Compressor bottom temp.)	Activate	108 °C Compressor stop
		Reset	After 3 minutes, and 80 °C or less Compressor restart
	Thermal protection program (Outdoor temp.) (Only in COOL or DRY mode)	Activate	-20 °C Compressor stop
		Reset	-15 °C Compressor restart

13. Function settings

13-1. Setting methods

⚠ WARNING

Never touch electrical components such as the terminal blocks or reactor except the switch on the display board. It may cause a serious accident such as electric shock.

⚠ CAUTION

- Once refrigerant charging is completed, be sure to open the valve prior to performing the local settings. Otherwise, the compressor may fail.
- Discharge any static electricity from your body before touching the push switches. Never touch any terminal or pattern of any parts on the control board.

The positions of the switches on the outdoor unit control board are shown in the figure below.

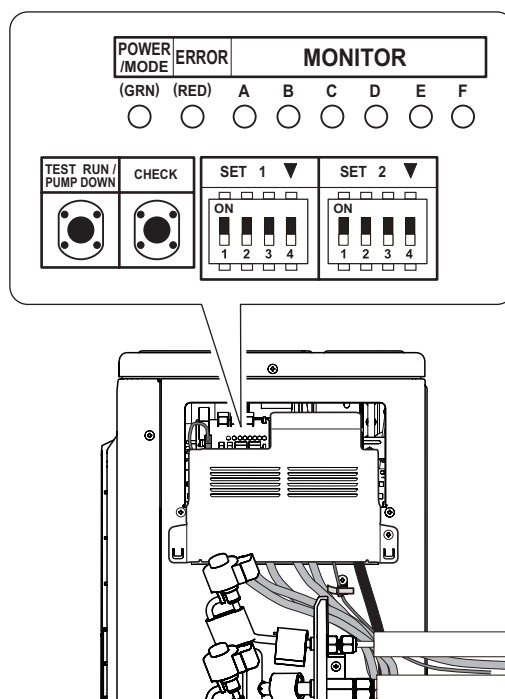

■ Setting method

Various settings can be adjusted by changing DIP switches and push switches on the PCB of the outdoor unit.

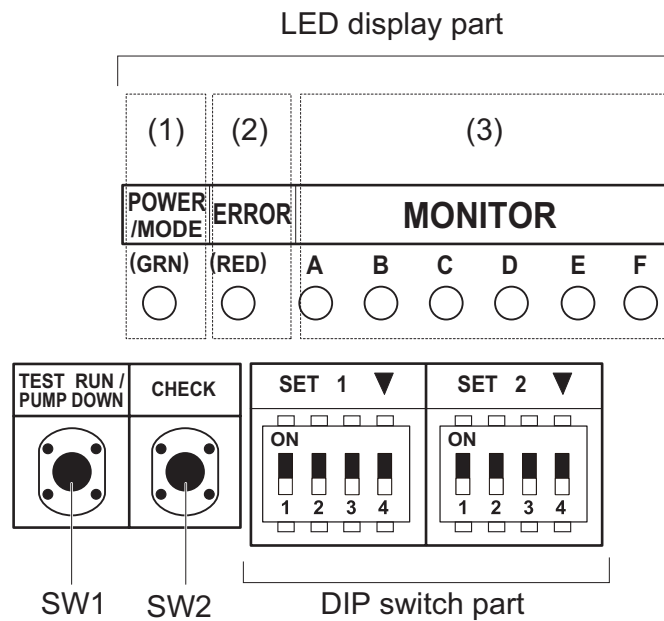

1. Be sure to disconnect the power supply or turn off the breaker.
2. Change the DIP switch setting according to the required setting.

■ Description of display

LED lamp			Function or operation method
(1)	POWER/MODE	Green	<ul style="list-style-type: none"> Turns on when the power supply is ON (Including when error occurs). Indicate the MODE by the number of flashes when the installation function is active.
(2)	ERROR	Red	Flashes at high-speed when there is an error.
(3)	MONITOR	A	<ul style="list-style-type: none"> Displays the location and contents of errors when there is an error. (Refer to "Error code" on page 446 for details.) Displays when check run is activated. (Refer to "Check run" on page 439 for details.)
		B	
		C	
		D	
		E	
		F	

Switch		Function or operation method	Factory setting
SW1	Push	<ul style="list-style-type: none"> For the test run start and stop. For the pump down start and stop. 	—
SW2	Push	<ul style="list-style-type: none"> For when check run function is activated. For displaying the check run. For resetting the Automatic wiring correction memory. 	—
SET1-1	DIP	For selecting cooling or heating during test operation.	OFF
SET1-2	DIP	For switching SW1 operation.	OFF
SET1-3	DIP	(Prohibited)	OFF (Do not change)
SET1-4	DIP	For outdoor unit low noise operation function.	OFF
SET2-1	DIP	For selecting outdoor unit low noise operation function.	OFF
SET2-2	DIP	(Prohibited)	OFF (Do not change)
SET2-3	DIP	Changing the current limit	OFF
SET2-4	DIP		

Be sure to disconnect the power supply or turn off the breaker before changing the DIP switch setting.

13-2. Outdoor unit low noise operation function (option)

Change the outdoor unit low noise operation by using this setting.

⚠ CAUTION

- When the low noise operation function is working, cooling and heating capacity will decrease.
- When changing the settings, explain to the customer beforehand that the capacity decreases.

NOTES:

- When SET1-4 is OFF, optional Central remote controller is required to use this function.
- When SET1-4 is ON, "Operation" and "Non-operation" mode of this function cannot be switched from the Central remote controller.

SET1-4	Setting	Factory setting
ON	Continuous operation	
OFF	Follow the Central remote controller settings	◆

SET2-1	Setting	Factory setting
ON	Lower	
OFF	Low	◆

13-3. Changing the current limit function

Change the outdoor unit current limit function by using this setting.

⚠ CAUTION

- When the current limited function is working, cooling and heating capacity will decrease.
- When changing the settings, explain to the customer beforehand that the capacity decreases.

SET2-3	SET2-4	Current	Factory setting
OFF	OFF	Full	◆
ON	OFF	16.0 A	
OFF	ON	12.0 A	

14. Check and test

14-1. Check run

- The check run is a function to screen and detect any wiring errors.
- After carrying out the check run, you can use the automatic wiring correction function to correct the wiring.
- Normal operation is possible without using the check run. In this case, use the test run or forced cooling function of the indoor unit to confirm any wiring errors.

■ Things to confirm before starting the check run

To ensure safety, check that the following work, inspections and operations have been completed.

	Check item	Check column
1	Check that all work on the piping connecting the outdoor unit, indoor units has been completed.	
2	Check that all work on the wiring connecting the outdoor unit, indoor units has been completed.	
3	Is there a gas leakage? (At pipe connections [flange connections and brazed areas])	
4	Is the system charged with the specified volume of refrigerant?	
5	Is a breaker installed at the power supply cable of outdoor unit?	
6	Are the wires connected to the terminals without looseness, and in accordance with the specifications?	
7	Is the 3-way valve of the outdoor unit open? (Gas pipe and liquid pipe)	
8	Is the power supply connected for more than 12 hours?	

■ Restrictions applicable when performing the check run

- When the check run starts, all indoor units connected to the outdoor unit will start to run automatically. During the check run, you cannot check the operation of the indoor units separately. After the check run, check the operation of the indoor units separately in normal operation.
- The check run can be used when the temperature is within the operable temperature of the air conditioner.
- In the check run, the air conditioner will automatically switch between cooling and heating depending on the external temperature and internal temperature.
- The check run can be completed in about 30 minutes (cooling) or about 1 hour (heating), but may take more depending on the external and internal temperature conditions etc.
- Do not conduct the check run with all the windows in the room closed. Otherwise the room temperature could get too low or too high.
- Depending on the difference of the room temperature of each room, a judgment may be impossible.
- Check run is a special operation so there may be a noise louder than the normal refrigerant noise or a creaking noise.

■ Operating procedure for check run

⚠ CAUTION

Initiate check run after more than 12 hours after the power supply is connected.

NOTE: Be sure that the indoor unit and outdoor unit are not operating before starting the check run.

1. Press the CHECK switch for 3 seconds or more.

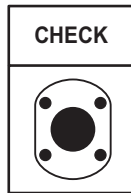

2. The number of indoor units (and the places) connected through the communication lines is displayed.
 - If the displayed number of units (places) and the installed number of units (places) is the same, proceed to step 3.
 - If the displayed number of units (places) and the installed number of units (places) is not the same, shut off the power and check whether the indoor and outdoor communication lines are properly connected.
 - If there is no operation for 1 minute, the LED will return to the original display. (POWER/MODE LED: ON)

Example: When 4 indoor units (A to D) are connected

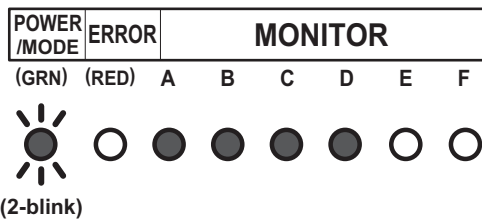

3. Press the CHECK switch for 3 seconds or more again. Check run is initiated.
 - When check run is initiated, all LEDs from A to F will flash. (Preliminary operation)
 - The LED for each indoor unit will switch off in order as check for each unit is completed.

NOTE: To interrupt the check run, press the CHECK switch.

Example: When 4 indoor units (A to D) are connected

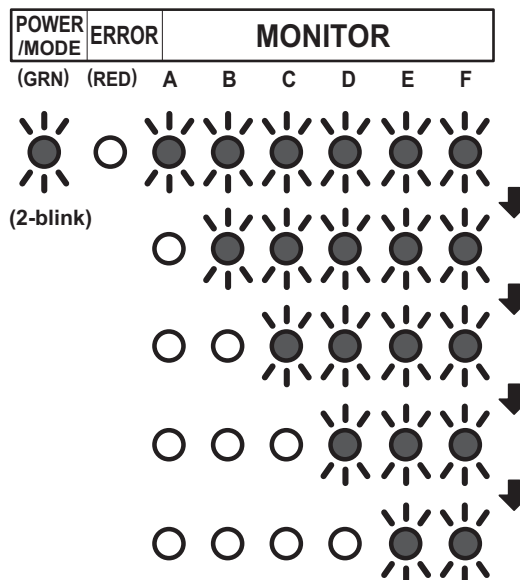

4. After the check run is completed, results will be displayed. Fill the displayed results in the result table accordingly.

- **If the connection is correct (Example: When 4 indoor units are connected)**

After the number of connected units are displayed, the LED for each unit will light up in order from A to D.

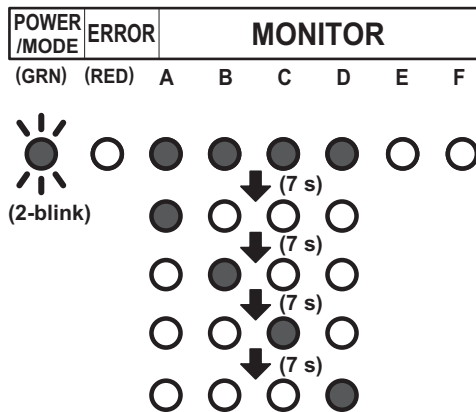

- **If the connection is incorrect (Example: When connection of B and C of the 4 units are reversed)**

After the number of connected units are displayed, B and C will light up in reverse.

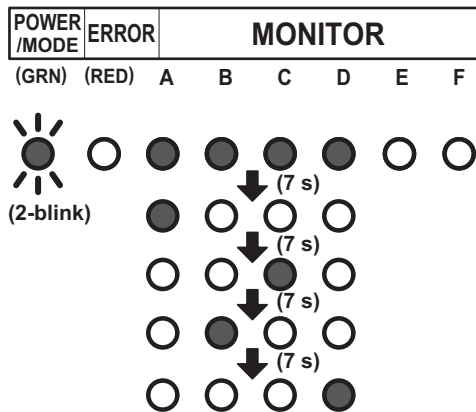

NOTES:

- Automatic wiring correction will not be completed if the power supply is disconnected while displaying the results. To confirm the automatic wiring correction, be sure to carry out step 5.
- If frost is formed on the outdoor unit while displaying the results, automatic defrost function will be operated. Proceed to step 5 after the defrost function is finished.

[How to record the contents]

- Fill the displayed results according to the following example.

Example: When piping A to D is connected but the wires for B and C are connected in reverse.

<Displayed results>

The LEDs will light up in 7 second intervals in the following order.

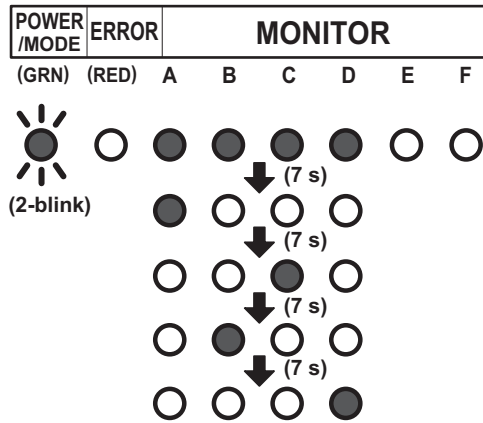

<Example of result table>

- Write a ● where the LEDs light up in the order that they light up.

	A	B	C	D	E	F
1	●	●	●	●	○	○
2	●	○	○	○	○	○
3	○	○	●	○	○	○
4	○	●	○	○	○	○
5	○	○	○	●	○	○
6	○	○	○	○	○	○
7	○	○	○	○	○	○

- Based on the results of step (a), record as follows.

- Trace the dotted circle with a pen if multiple places light up.

A	B	C	D	E	F
○	○	○	○	⋯	⋯

- Write the order from A to D in which the LEDs lit up inside the circle.

A	B	C	D	E	F
Ⓐ	Ⓒ	Ⓑ	Ⓓ	⋯	⋯

OUTDOOR UNIT
AOYG36KBTAs

OUTDOOR UNIT
AOYG36KBTAs

c. Select the correction method.

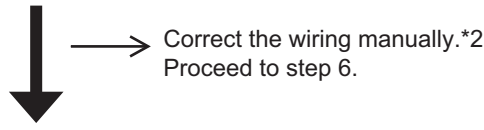

Use the Automatic wiring correction function.*1
Proceed to step 5.

Write down the same results in the label on the reverse side of the service panel.
The results recorded are needed at the time of servicing.

<Result Table>

	A	B	C	D	E	F
1	○	○	○	○	○	○
2	○	○	○	○	○	○
3	○	○	○	○	○	○
4	○	○	○	○	○	○
5	○	○	○	○	○	○
6	○	○	○	○	○	○
7	○	○	○	○	○	○

A	B	C	D	E	F
○	○	○	○	○	○

NOTES:

- *1: By using this function, the wiring is automatically corrected according to the piping.
- *2: When correcting the wiring manually, please disconnect the power supply or turn off the breaker during results display, and then change the wiring manually according to the obtained test results.

For example, in Example 1, the wirings connected to the terminals B and C is to be exchanged manually.

- During results display, press the CHECK switch for 3 seconds or more.
After LEDs A to F have lit in turn, all LEDs will light up indicating that the automatic wiring correction is completed.

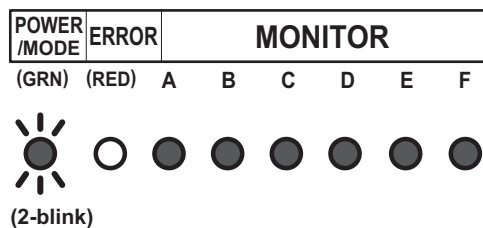

- Disconnect the power supply or turn off the breaker and wait 10 minutes then turn the power back on and perform test run.

NOTE: If you do not disconnect the power supply or turn off the breaker, normal operation is not possible.

Notices:

- If an error occurs during check run it will be suspended. Correct the error and start check run again.
- After the check run, if automatic wiring correction is carried out, the indoor unit's position will be modified to match the piping. (Note that the display of the optional remote controller changes.)
- If you start check run again after the automatic wiring correction is finished, the modification will be reset.

OUTDOOR UNIT
AOYG36KBT A5

OUTDOOR UNIT
AOYG36KBT A5

■ Failure indication of check-run judgment

The check run stops when there is an error, and the LED shows the relevant error indication. When you encounter the errors described here, perform checking by using the cooling test run of the indoor unit.

• Temperature out of range judgment

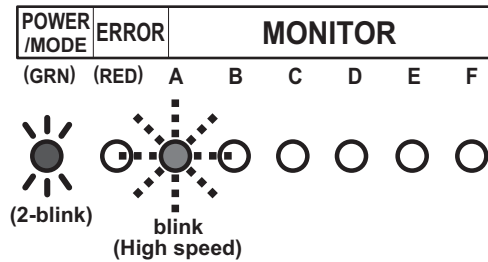

• Wiring/piping number difference

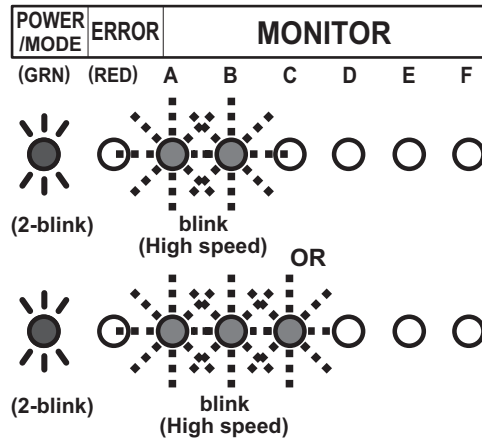

■ Redisplaying the results of check run

- When checking the content of automatic wiring correction, push the CHECK switch. The results of the check run is displayed. You can compare the result that is recorded in step (4) of "Chapter 14-1-3. ["Operating procedure for check run"](#) on page 364".
- If the automatic wiring correction is not completed, the POWER/MODE LED blinks twice and the MONITOR LED turns off.

■ Memory resetting of automatic wiring correction

⚠ CAUTION

When relocating the unit, reset the memory beforehand, or the unit may not function normally.

- Push the CHECK switch.
The LED lights as shown in ["Redisplaying the results of check run"](#) on page 368".
- When the LED is on, press the CHECK switch for more than 3 seconds.
- The LEDs from A to F light in sequence, and then all LEDs light to indicate the completion of the memory resetting of automatic wiring correction.
- Disconnect the power supply or turn off the breaker.

14-2. Test run

⚠ CAUTION

Always connect the power supply 12 hours prior to the start of the operation in order to protect the compressor.

1. Indoor unit
 - a. Is the drain normal?
 - b. Is there any abnormal noise and vibration during operation?
 2. Outdoor unit
 - a. Is there any abnormal noise and vibration during operation?
 - b. Will noise, wind, or drain water from the unit disturb the neighbors?
 - c. Is there any gas leakage?
- Do not operate the air conditioner in the test running state for a long time.
 - For the operation method of the test run for indoor unit and central remote controller, refer to the operating manual and perform operation check.

■ Test run method

Be sure to temporarily disconnect the power supply or turn off the breaker before changing the DIP switch settings.

1. Check the 3-way valves (both at the liquid side and gas side) are opened. Confirm that the DIP switch SET1-2 is switched off.
2. Set the operation mode to COOL or HEAT. When switching the DIP switch SET1-1 between HEAT and COOL, disconnect the power supply or turn off the circuit breaker beforehand.

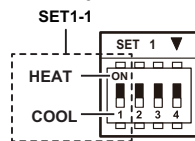

- In the first test run, be sure to set the operation mode to COOL.
 - The operation mode cannot be switched between COOL and HEAT during the test run. To switch the operation mode between COOL and HEAT, stop the test run, switch the operation mode, and then start the test run again.
3. Push TEST RUN switch for more than 3 seconds. The POWER / MODE LED flashes once.

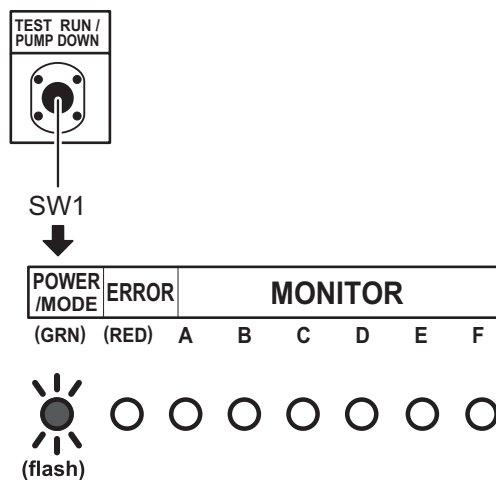

4. Confirm operating status.

5. Push TEST RUN switch for more than 3 seconds.

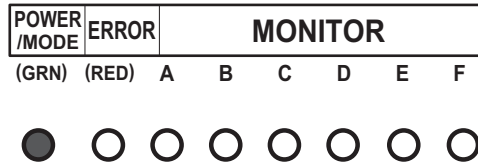

POWER/MODE LED will turn on, and test run stops.

14-3. Error code

If an error occurs, the LED lights to inform the relevant location and the code. When error occurs, the error LED blinks at high speed.

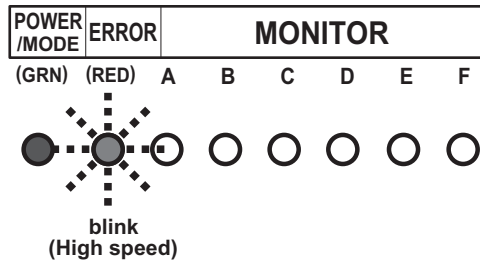

■ Error location

LEDs A to F of MONITOR light and indicate the location of the error. In the case of an overall error, LEDs A to F of MONITOR do not light.

Example: Coil error on indoor unit B

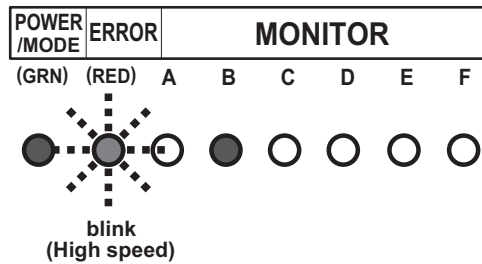

■ Error code display

While the error is occurring, briefly push the SW1. The error code is displayed.

Example: Coil error (Error cord = 9A.1)

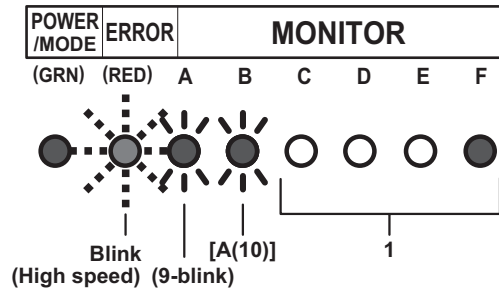

Display mode

LED on: ●

LED off: ○

Blink: 
 (0.5s Light on / 0.5s Light off)

Number of blinking: ()

For MONITOR (A and B)

- A: 10-blink
- C: 11-blink
- F: 12-blink
- J: 13-blink
- P: 14-blink
- U: 15-blink

C	D	E	F	
○	○	○	●	→ 1
○	○	●	○	→ 2
○	○	●	●	→ 3
○	●	○	○	→ 4
○	●	○	●	→ 5
○	●	●	○	→ 6
○	●	●	●	→ 7
●	○	○	○	→ 8
●	○	○	●	→ 9
●	○	●	○	→ A
●	○	●	●	→ C
●	●	○	○	→ F
●	●	○	●	→ J
●	●	●	○	→ P
●	●	●	●	→ U

OUTDOOR UNIT
AOYG36KBT A5

OUTDOOR UNIT
AOYG36KBT A5

Error code	Error type
11.3	Serial communication error
11.4	Serial communication error during operation
16.5	Communication error between controller and outdoor unit
22.1	Indoor unit capacity error
23.1	Connection prohibited (Series error)
5U.1	Indoor unit error
62.1	PCB model information error
62.3	EEPROM access error
62.8	EEPROM data corruption error
63.1	Inverter error
65.3	IPM error (Trip terminal L error)
71.1	Discharge temp. sensor error
72.1	Compressor temp. sensor error
73.2	Heat exchanger middle temp. sensor error
73.3	Heat exchanger liquid temp. sensor error
74.1	Outdoor temp. sensor error
75.1	Suction gas temp. sensor error
76.1	Valve sensor error
76.2	
77.1	Heat sink temp. sensor error
84.1	Current sensor 1 error (stoppage permanently)
86.1	Discharge pressure sensor error
86.4	High pressure switch 1 error
94.1	Trip detection
95.1	Compressor motor control error (stoppage permanently)
97.3	Fan motor 1 error (Duty error)
98.3	Fan motor 2 error (Duty error)
99.1	4-way valve error
9A.1	Coil 1 (expansion valve 1) error
A1.1	Discharge temperature 1 error (stoppage permanently)
A3.1	Compressor 1 temperature error

14-4. Pump down

⚠ WARNING

During the pump down operation, make sure that compressor is off before you remove the refrigerant piping. Do not remove the connection pipe while the compressor is in operation with valve open. This may cause abnormal pressure in the refrigeration cycle that leads to breakage and even injury.

■ Pump down operation

When moving or discarding the air conditioner, in order to consider the environment and avoid the discharge of refrigerant to the atmosphere, pump down according to the following procedure.

1. Connect the pressure gauge to the charging port.
2. Change the DIP switch on the board (SET1-2) to ON.
*Be sure the power supply is disconnected on the breaker is turned off when changing the DIP switch.

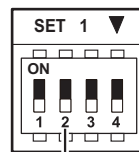

DIP switch
(SET1-2)

3. To start operation, push the PUMP DOWN switch (SW1) for 3 seconds or push the switch after the power has been on for 3 minutes.



Push switch (SW1)

During pump down, the LED (POWER/MODE) blinks 3 times consecutively.



(3-blink)

NOTE: If the PUMP DOWN switch (SW1) is pushed while the compressor is in operation, the compressor stops and the operation restart after about 3 minutes.

4. Close the liquid pipe valve.
5. When the value between 7.3 psi and 0 psi (0.05 Mpa to 0 Mpa) is shown, close the gas pipe valve.
6. Stop the pump down operation by pushing the PUMP DOWN switch (SW1) for 3 seconds. The LED light as follows.

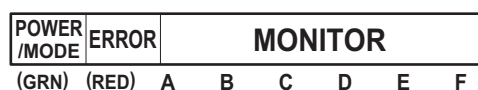

(3-blink)

7. Disconnect the power supply or turn off the breaker.



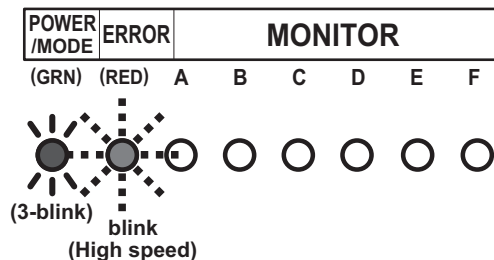

- NOTE:**
- Even if the pump down operation is not stopped by pushing the switch as in step 6, the operation stops automatically after 15 minutes, and the LED light as follows.

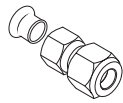

- After completing the pump down operation, disconnect the power supply or turn off the breaker.
 - If the pump down operation still continues, open the liquid pipe valve. Then perform the procedure again starting from step 3.
- To cancel the pump down operation, push the PUMP DOWN switch (SW1) again. The indication of the LED returns to the original state which is before starting the pump down operation.
(POWER/MODE LED: On)
 - The pump down may stop before completion due to an error. To complete the pump down operation, correct the error, open the liquid pipe valve and then start from step 1 again. Otherwise, the refrigerant can be recovered from the service port.

15. Accessories

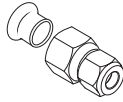
15-1. Model: AOYG36KBTA5

Part name	Exterior	Q'ty	Part name	Exterior	Q'ty
Installation manual		1	Adapter K: mm (in) 12.70 (1/2) to 9.52 (3/8)		2
Drain pipe		1	Adapter H: mm (in) 9.52 (3/8) to 12.70 (1/2)		1
Cable tie (small)		1			

16. Optional parts

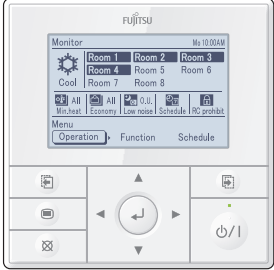
Exterior	Part name	Model name	Summary
	Central remote controller	UTY-DMMYM1	<p>Set temperatures on timers to best meet individuals' needs. Includes a large backlit LCD and 4-way navigation pad. Remote controller cable: 0.33 mm² (22AWG)</p> <p>NOTES:</p> <ul style="list-style-type: none"> The remote controller cable supplied with this controller is for indoor use. If the cable for outdoor use is required, purchase an appropriate cable locally. Material is not specified. However, it should be selected considering the installing environment (temperature, humidity), and regional regulations (RoHS Directive, etc.). The cable from the central remote controller should be connected to connector (P400) of the outdoor unit.

17. Outdoor unit installation precautions

NOTE: The information listed below are general precautions.
Some models also include items that do not apply.

17-1. Places where prohibited for use

- Places where there is a danger of combustible gas leakage.
- Places where sulfur gas, chlorine gas, acid, alkali, or other matter which effects equipment is generated.
- Places affected by heat radiation from other heat sources.
- Places where the air is stagnant.
- Places where machinery which generates high frequencies is used.
- Ocean beaches and other areas where there is a lot of salt.
- Inside of vehicles, ships, and other conveyances.
- Places where voltage fluctuations are large such as a factory.

17-2. Points to remember when installing

- The product shall be installed at a place which can withstand the weight and vibration of the outdoor unit.
- To allow maintenance after refrigerant piping, drain piping, and electric wiring connection and installation, provide an installation service space.
*Installation service space is shown in "[Installation space](#)" on page 307.
- Be careful when installing the set at the following places.

Condition	Contents	Countermeasures (Reference)
When installed near adjacent houses.	Perform installation work so that operating sound does not disturb the neighbors.	<ol style="list-style-type: none"> 1. Install a soundproof barrier. 2. Change the installation site.
When there is the possibility of strong wind.	<ul style="list-style-type: none"> • If the outdoor unit is exposed to strong wind, capacity may drop, frost may form during heating, and operation may be stopped by high pressure rise. In addition, when a very strong wind blows, the fan may be damaged. • When a very strong wind blows, there is the possibility of the outdoor unit being toppled over if held only by foundation bolts. 	<ol style="list-style-type: none"> 1. Install the outdoor unit with keeping a sufficient distance between the outlet side of the unit and a facing wall or fence. 2. Make the outlet direction and wind direction perpendicular. 3. Fasten the outdoor unit using toppling prevention hardware (purchased locally).
When snow accumulates.	If the outdoor unit is covered by accumulated snow, it may not be able to operate.	<ol style="list-style-type: none"> 1. Make the foundation as high as possible. 2. Perform snow prevention work.
When installing the inverter type.	It may generate noise in TV sets, stereos and PCs.	The inverter type should be installed at a sufficient distance from these equipments.