

AIR CONDITIONER

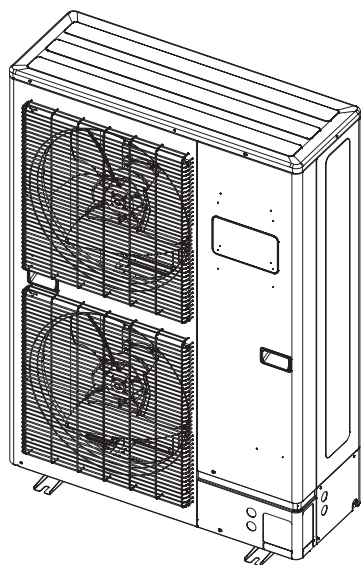

INSTALLATION MANUAL

OUTDOOR UNIT (3 Phase Type)

For authorized service personnel only.

English

INSTALLATIONSANLEITUNG

AUSSENGERÄT (3-Phasen-Typ)

Nur für autorisiertes Fachpersonal.

Deutsch

MANUEL D'INSTALLATION

APPAREIL EXTÉRIEUR (type 3 phases)

Pour le personnel d'entretien autorisé uniquement.

Français

MANUAL DE INSTALACIÓN

UNIDAD EXTERIOR (Tipo trifásico)

Únicamente para personal de servicio autorizado.

Español

MANUALE DI INSTALLAZIONE

UNITÀ ESTERNA (tipo a 3 fasi)

A uso esclusivo del personale tecnico autorizzato.

Italiano

ΕΓΧΕΙΡΙΔΙΟ ΕΓΚΑΤΑΣΤΑΣΗΣ

ΕΞΩΤΕΡΙΚΗ ΜΟΝΑΔΑ (Τριφασικού Τύπου)

Μόνο για εξουσιοδοτημένο τεχνικό προσωπικό.

Ελληνικά

MANUAL DE INSTALAÇÃO

UNIDADE EXTERIOR (Tipo trifásica)

Apenas para pessoal de assistência autorizado.

Português

РУКОВОДСТВО ПО УСТАНОВКЕ

ВНЕШНИЙ МОДУЛЬ (3-фазного типа)

Только для авторизованного обслуживающего персонала.

Русский

MONTAJ KILAVUZU

DIŞ ÜNİTE (3 Faz Tipi)

Yalnızca yetkili servis personeli için.

Türkçe



PART No. 9379069274-05

Contents

| | |
|---|----|
| 1. SAFETY PRECAUTIONS..... | 2 |
| 2. ABOUT THE UNIT | |
| 2.1. Precautions for using R410A refrigerant..... | 2 |
| 2.2. Special tools for R410A..... | 3 |
| 2.3. Accessories..... | 3 |
| 3. INSTALLATION WORK | |
| 3.1. Selecting an installation location..... | 3 |
| 3.2. Drain installation..... | 4 |
| 3.3. Installation dimensions..... | 4 |
| 3.4. Transporting the unit..... | 5 |
| 3.5. Installation..... | 5 |
| 4. PIPE SELECTION | |
| 4.1. Selecting the pipe material..... | 5 |
| 4.2. Protection of pipes..... | 5 |
| 4.3. Refrigerant pipe size and allowable piping length..... | 5 |
| 4.4. Connectable pipe diameter and max. piping length..... | 6 |
| 5. PIPE INSTALLATION-1 | |
| 5.1. Opening a knock out hole..... | 7 |
| 5.2. Brazing..... | 7 |
| 5.3. Indoor unit pipe connections..... | 7 |
| 5.4. Flare connection (pipe connection)..... | 7 |
| 5.5. Sealing test..... | 8 |
| 5.6. Vacuum process..... | 8 |
| 5.7. Additional charging..... | 9 |
| 6. ELECTRICAL WIRING | |
| 6.1. Notes for electrical wiring..... | 10 |
| 6.2. Selecting circuit breaker and wiring..... | 11 |
| 6.3. Knock out holes for wiring..... | 11 |
| 6.4. Wiring method..... | 11 |
| 7. PIPE INSTALLATION-2 | |
| 7.1. Installing insulation..... | 12 |
| 7.2. Filling with putty..... | 12 |
| 8. HOW TO OPERATE DISPLAY UNIT | |
| 8.1. Various setting methods..... | 12 |
| 8.2. Description of display..... | 13 |
| 9. LOCAL SETTING | |
| 9.1. Low noise mode (Local work)..... | 13 |
| 9.2. Peak cut mode (Local work)..... | 14 |
| 10. TEST RUN | |
| 10.1. Check items before performing the test run..... | 14 |
| 10.2. Test run method..... | 14 |
| 11. PUMP DOWN | |
| 11.1. Preparation for pump down..... | 15 |
| 11.2. Pump down procedure..... | 15 |
| 12. ERROR CODE DISPLAY | |
| 12.1. How to check error code..... | 16 |
| 12.2. Error code check table..... | 16 |

1. SAFETY PRECAUTIONS

- Be sure to read this manual carefully before installation.
- The warnings and precautions indicated in this manual contain important information pertaining to your safety. Be sure to observe them.
- Hand this manual, together with the operating manual, to the customer. Request the customer to keep them on hand for future use, such as for relocating or repairing the unit.

WARNING

This mark indicates procedures which, if improperly performed, might lead to the death or serious injury of the user.

CAUTION

This mark indicates procedures which, if improperly performed, might possibly result in personal harm to the user, or damage to property.

WARNING

Never touch electrical components immediately after the power supply has been turned off. Electrical shock may occur. After turning off the power, always wait 10 minutes or more before touching electrical components.

Request your dealer or a professional installer to install the outdoor unit in accordance with this installation manual. An improperly installed unit can cause serious accidents such as water leakage, electric shock, or fire.
 If the outdoor unit is installed in disregard of the instructions in the installation manual, it will void the manufacturer's warranty.

Do not turn ON the power until all work has been completed. Turning ON the power before the work is completed can cause serious accidents such as electric shock or fire.

If refrigerant leaks while work is being carried out, ventilate the area. If the refrigerant comes in contact with a flame, it produces a toxic gas.

Installation work must be performed in accordance with national wiring standards by authorized personnel only.

WARNING

Do not use this equipment with air or any other unspecified refrigerant in the refrigerant lines.
 Excess pressure can cause a rupture.

During installation, make sure that the refrigerant pipe is attached firmly before you run the compressor.

Do not operate the compressor under the condition of refrigerant piping not attached properly with 2-way or 3-way valve open. This may cause abnormal pressure in the refrigeration cycle that leads to rupture and even injury.

When installing and relocating the air conditioner, do not mix gases other than the specified refrigerant (R410A) to enter the refrigerant cycle.
 If air or other gas enters the refrigerant cycle, the pressure inside the cycle will rise to an abnormally high value and cause rupture, injury, etc.

For the air conditioner to operate satisfactorily, install it as outlined in this installation manual.

Connect the indoor unit and outdoor unit with the air conditioner piping and cable available standards parts.

This installation manual describes the correct connections using the installation set available from our standard parts.

Also, do not use an extension cable.

Do not purge the air with refrigerants but use a vacuum pump to vacuum the installation.

There is not extra refrigerant in the outdoor unit for air purging.

Use a vacuum pump for R410A exclusively.

Using the same vacuum pump for different refrigerants may damage the vacuum pump or the unit.

Use a clean gauge manifold and charging hose for R410A exclusively.

During the pump-down operation, make sure that the compressor is turned off before you remove the refrigerant piping.

Do not remove the connection pipe while the compressor is in operation with 2 way or 3 way valve open. This may cause abnormal pressure in the refrigeration cycle that leads to rupture and even injury.

CAUTION

Read carefully all security information before use or install the air conditioner.

Do not attempt to install the air conditioner or a part of the air conditioner by yourself.

This unit must be installed by qualified personnel with a capacity certificate for handling refrigerant fluids. Refer to regulation and laws in use on installation place.

The installation must be carried out in compliance with regulations in force in the place of installation and the installation instructions of the manufacturer.

This unit is part of a set constituting an air conditioner. It must not be installed alone or with non-authorized by the manufacturer.

Always use a separate power supply line protected by a circuit breaker operating on all wires with a distance between contact of 3mm for this unit.

The unit must be correctly earthed (grounded) and the supply line must be equipped with a differential breaker in order to protect the persons.

The units are not explosion proof and therefore should not be installed in explosive atmosphere.

This unit contains no user-serviceable parts. Always consult authorized service personnel to repairs.

When moving, consult authorized service personnel for disconnection and installation of the unit.

Children should be monitored to ensure they do not play with the device.

This appliance is not intended for use by persons (including children) with reduced physical, sensory or mental capabilities, or lack of experience and knowledge, unless they have been given supervision or instruction concerning use of the appliance by a person responsible for their safety. Children should be supervised to ensure that they do not play with the appliance.

Do not touch the aluminum fins of heat exchanger built-in the indoor or outdoor unit to avoid personal injury when you install or maintain the unit.

Do not place any other electrical products or household belongings under indoor unit or outdoor unit. Dripping condensation from the unit might get them wet, and may cause damage or malfunction of your property.

2. ABOUT THE UNIT

2.1. Precautions for using R410A refrigerant

WARNING

Do not introduce any substance other than the prescribed refrigerant into the refrigeration cycle. If air enters the refrigeration cycle, the pressure in the refrigeration cycle will become abnormally high and cause the piping to rupture.

If there is a refrigerant leak, make sure that it does not exceed the concentration limit. If a refrigerant leak exceeds the concentration limit, it can lead to accidents such as oxygen starvation.

| ⚠ WARNING |
|--|
| Do not touch refrigerant that has leaked from the refrigerant pipe connections or other areas. Touching the refrigerant directly can cause frostbite. |
| If a refrigerant leak occurs during operation, immediately vacate the premises and thoroughly ventilate the area. If the refrigerant comes in contact with a flame, it produces a toxic gas. |
| The basic installation work procedures are the same as conventional refrigerant models. However, pay careful attention to the following points: |
| <ul style="list-style-type: none"> Since the working pressure is 1.6 times higher than that of conventional refrigerant (R22) models, some of the piping and installation and service tools are special. (See the table below.) Especially, when replacing a conventional refrigerant (R22) model with a new refrigerant R410A model, always replace the conventional piping and flare nuts with the R410A piping and flare nuts. Models that use refrigerant R410A have a different charging port thread diameter to prevent erroneous charging with conventional refrigerant (R22) and for safety. Therefore, check beforehand. [The charging port thread diameter for R410A is 1/2 UNF 20 threads per inch.] Be careful that foreign matter (oil, water, etc.) does not enter the piping than with refrigerant models. Also, when storing the piping, securely seal the openings by pinching, taping, etc. When charging the refrigerant, take into account the slight change in the composition of the gas and liquid phases. And always charge from the liquid phase where refrigerant composition is stable. |

2.2. Special tools for R410A

| ⚠ WARNING |
|--|
| To install a unit that uses R410A refrigerant, use dedicated tools and piping materials that have been manufactured specifically for R410A use. Because the pressure of R410A refrigerant is approximately 1.6 times higher than R22, failure to use dedicated piping material or improper installation can cause rupture or injury. Furthermore, it can cause serious accidents such as water leakage, electric shock, or fire. |

| Tool name | Changes |
|----------------------|--|
| Gauge manifold | Pressure is high and cannot be measured with a conventional gauge. To prevent erroneous mixing of other refrigerants, the diameter of each port has been changed. It is recommended the gauge with seals -0.1 to 5.3 MPa (-1 to 53 bar) for high pressure. -0.1 to 3.8 MPa (-1 to 38 bar) for low pressure. |
| Charging hose | To increase pressure resistance, the hose material and base size were changed. |
| Vacuum pump | A conventional vacuum pump can be used by installing a vacuum pump adapter. |
| Gas leakage detector | Special gas leakage detector for HFC refrigerant R410A. |

Copper pipes

It is necessary to use seamless copper pipes and it is desirable that the amount of residual oil is less than 40 mg/10 m. Do not use copper pipes having a collapsed, deformed or discolored portion (especially on the interior surface). Otherwise, the expansion valve or capillary tube may become blocked with contaminants.
As an air conditioner using R410A incurs pressure higher than when using conventional refrigerant, it is necessary to choose adequate materials.
Thicknesses of copper pipes used with R410A are as shown in the table. Never use copper pipes thinner than that in the table even when it is available on the market.

Thicknesses of Annealed Copper Pipes (R410A)





| Pipe outside diameter [mm (in.)] | Thickness [mm] |
|----------------------------------|----------------|
| 6.35 (1/4) | 0.80 |
| 9.52 (3/8) | 0.80 |
| 12.70 (1/2) | 0.80 |
| 15.88 (5/8) | 1.00 |
| 19.05 (3/4) | 1.20 |

2.3. Accessories

| ⚠ WARNING |
|---|
| For installation purposes, be sure to use the parts supplied by the manufacturer or other prescribed parts. The use of non-prescribed parts can cause serious accidents such as the unit falling, water leakage, electric shock, or fire. |

Following installation parts are supplied. Use them as required.

Keep this manual in a safe place, and do not discard any other accessories until the installation work has been completed.

| Name and shape | Q'ty | Description |
|---|------|---|
| Installation manual  | 1 | This manual |
| Drain pipe  | 1 | For outdoor unit drain piping work (May not be supplied, depending on the model.) |
| Drain cap  | 2 | |
| One-touch bush  | 2 | For power supply cable and connection cable installation |

3. INSTALLATION WORK

Make sure to obtain the customer's approval for selecting and installing the outdoor unit.

3.1. Selecting an installation location

| ⚠ WARNING |
|---|
| Securely install the outdoor unit at a location that can withstand the weight of the unit. Otherwise, the outdoor unit may fall and cause injury. |
| Be sure to install the outdoor unit as prescribed, so that it can withstand earthquakes and typhoons or other strong winds. Improper installation can cause the unit to topple or fall, or other accidents. |
| Do not install the outdoor unit near the edge of a balcony. Otherwise, children may climb onto the outdoor unit and fall off of the balcony. |

| ⚠ CAUTION |
|--|
| Do not install the outdoor unit in the following areas: <ul style="list-style-type: none"> Area with high salt content, such as at the seaside. It will deteriorate metal parts, causing the parts to fail or the unit to leak water. Area filled with mineral oil or containing a large amount of splashed oil or steam, such as a kitchen. It will deteriorate plastic parts, causing the parts to fail or the unit to leak water. Area that generates substances that adversely affect the equipment, such as sulfuric gas, chlorine gas, acid, or alkali. It will cause the copper pipes and brazed joints to corrode, which can cause refrigerant leakage. Area containing equipment that generates electromagnetic interference. It will cause the control system to malfunction, preventing the unit from operating normally. Area that can cause combustible gas to leak, contains suspended carbon fibers or flammable dust, or volatile inflammables such as paint thinner or gasoline. If gas leaks and settles around the unit, it can cause a fire. Area where small animals may live. It may cause failure, smoke or fire if small animals enter and touch internal electrical parts. Area where animals may urinate on the unit or ammonia may be generated. |

| |
|---|
| Do not tilt the outdoor unit more than 3 degrees. |
| Install the outdoor unit in a well-ventilated location away from rain or direct sunlight. |
| If the outdoor unit must be installed in an area within easy reach of the general public, install as necessary a protective fence or the like to prevent their access. |
| Install the outdoor unit in a location that would not inconvenience your neighbors, as they could be affected by the airflow coming out from the outlet, noise, or vibration. If it must be installed in proximity to your neighbors, be sure to obtain their approval. |
| If the outdoor unit is installed in a cold region that is affected by snow accumulation, snow fall, or freezing, take appropriate measures to protect it from those elements. To ensure a stable operation, install inlet and outlet ducts. |
| Install the outdoor unit in a location that is away from exhaust or the vent ports that discharge vapor, soot, dust, or debris. |
| Install the indoor unit, outdoor unit, power supply cable, transmission cable, and remote control cable at least 1 m away from a television or radio receivers. The purpose of this is to prevent TV reception interference or radio noise. (Even if they are installed more than 1 m apart, you could still receive noise under some signal conditions.) |

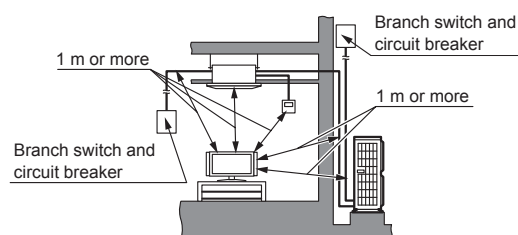

CAUTION

If children under 10 years old may approach the unit, take preventive measures so that they cannot reach the unit.

Keep the length of the piping of the indoor and outdoor units within the allowable range.

For maintenance purposes, do not bury the piping.

3.2. Drain installation

CAUTION

Perform drain work in accordance with this Manual, and ensure that the drain water is properly drained. If the drain work is not carried out correctly, water may drip down from the unit, wetting the furniture.

When the outdoor temperature is 0 °C or less, do not use the accessory drain pipe and drain cap. If the drain pipe and drain cap are used, the drain water in the pipe may freeze in extremely cold weather. (Reverse cycle model only)

- As the drain water flows out of the outdoor unit during heating operation, install the drain pipe and connect it to a commercial 16 mm hose. (Reverse cycle model only)
- When installing the drain pipe, plug all the holes other than the drain pipe mounting hole in the bottom of the outdoor unit with putty so there is no water leakage. (Reverse cycle model only)

(Unit : mm)

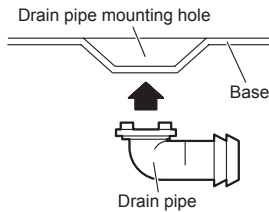
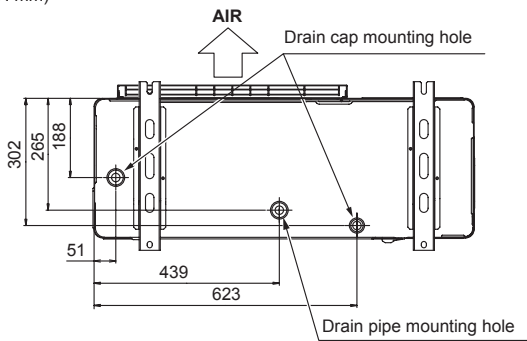

3.3. Installation dimensions

CAUTION

The installation space shown in the following examples is based on an ambient temperature under cooling operation of 35 °C (DB) at the air intake of the outdoor unit. Provide more space around the air intake than shown in the examples if the ambient temperature exceeds 35 °C (DB) or if the thermal load of all of the outdoor units exceeds the capacity.

Consider the transportation route, installation space, maintenance space, and access, and install the unit in a location with sufficient space for the refrigerant piping.

Observe the installation space specifications that are shown in the figures.

Keep the same space at rear air intake.

Provide the same space for the air intake at the rear of the outdoor unit.

If the installation is not performed according to the specifications, it could cause a short circuit and result in a lack of operating performance. As a result, the outdoor unit might easily be stopped by high-pressure protection.

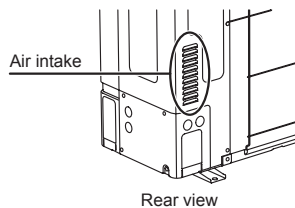

Installation methods not shown in the following examples are not recommended. Performance may drop significantly.

3.3.1. Single outdoor unit installation

When the upward area is open (Unit : mm)

(1) Obstacles at rear only

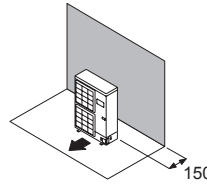

(2) Obstacles at rear and sides only

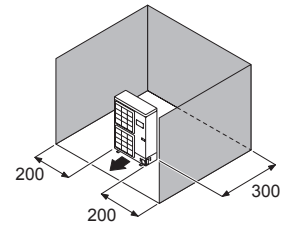

(3) Obstacles at front only

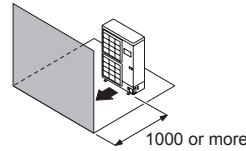

(4) Obstacles at front and rear only

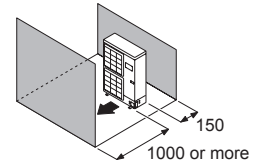

When an obstruction is present also in the upward area (Unit : mm)

(1) Obstacles at rear and above only

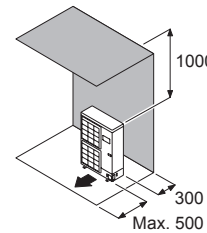

(2) Obstacles at rear, sides, and above only

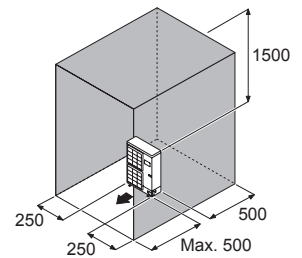

3.3.2. Multiple outdoor unit installation

- Provide at least 15 mm of space between the outdoor units if multiple units are installed.
- When routing the piping from the side of an outdoor unit, provide space for the piping.
- No more than 3 units must be installed side by side. When 3 units or more are arranged in a line, provide the space as shown in the following example when an obstruction is present also in the upward area.

When the upward area is open (Unit : mm)

(1) Obstacles at rear only

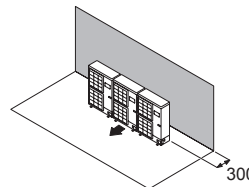

(2) Obstacles at front only

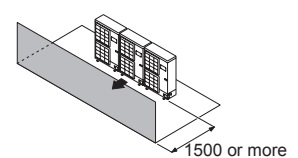

(3) Obstacles at front and rear only

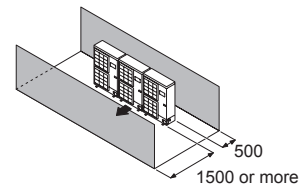

When an obstruction is present also in the upward area (Unit : mm)

Obstacles at rear and above only

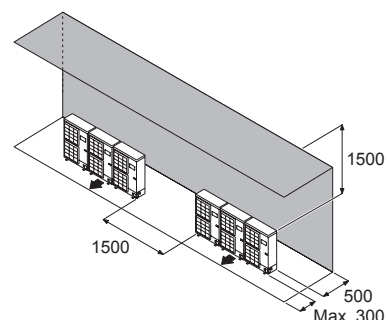

3.3.3. Outdoor units installation in multi row (Unit : mm)

(1) Single parallel unit arrangement

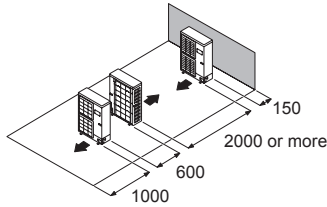

(2) Multiple parallel unit arrangement

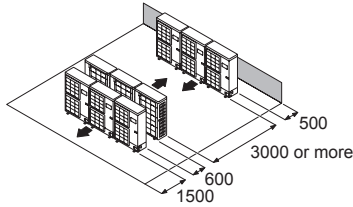

3.4. Transporting the unit

⚠ WARNING

Do not touch the fins.
Otherwise, personal injury could result.

⚠ CAUTION

When carrying the unit, hold the handles on the right and left sides and be careful.
If the outdoor unit is carried from the bottom, hands or fingers may be pinched.

- Carry slowly in the manner as shown on "Fig. B" holding the handles "Fig. A" in right and left sides. (Be careful not to touch with hands or objects.)
- Be sure to hold the handles on the sides of the unit. Otherwise, the suction grilles on the sides of the unit may be deformed.

Fig. A

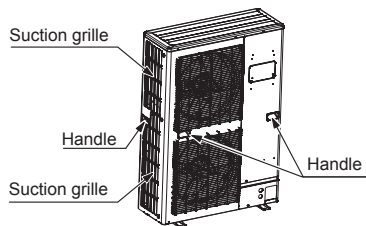
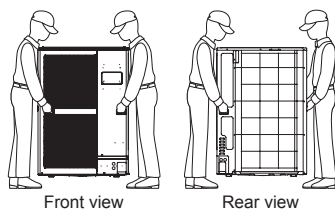
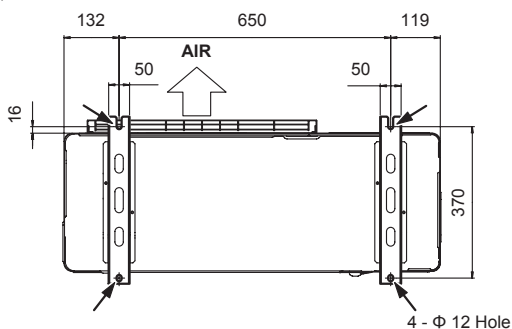

Fig. B



3.5. Installation

(Unit : mm)



- Install 4 anchor bolts at the locations indicated with arrows in the above figure.
- To reduce vibration, do not install the unit directly on the ground. Install it on a secure base (such as concrete blocks).

- The foundation shall support the legs of the unit and have a width of 50 mm or more.
- Depending on the installation conditions, the outdoor unit may spread its vibration during operation, which may cause noise and vibration. Therefore, attach damping materials (such as damping pads) to the outdoor unit during installation.
- Install the foundation, making sure that there is enough space for installing the connection pipes.
- Secure the unit to a solid block using foundation bolts. (Use 4 sets of commercially available M10 bolts, nuts, and washers.)
- The bolts should protrude 20 mm.
(Refer to the figure below.)
- If overturning prevention is required, purchase the necessary commercially available items.

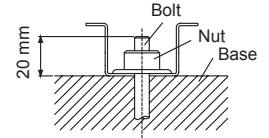

Fix securely with bolts on a solid block. (Use 4 sets of commercially available M10 bolt, nut and washer.)

4. PIPE SELECTION

4.1. Selecting the pipe material

⚠ CAUTION

Do not use existing pipes.

Use pipes that have clean external and internal sides without any contamination which may cause trouble during use, such as sulfur, oxide, dust, cutting waste, oil, or water.

It is necessary to use seamless copper pipes.
Material: Phosphor deoxidized seamless copper pipes.
It is desirable that the amount of residual oil is less than 40 mg/10 m.

Do not use copper pipes that have a collapsed, deformed, or discolored portion (especially on the interior surface). Otherwise, the expansion valve or capillary tube may become blocked with contaminants.

Improper pipe selection will degrade performance. As an air conditioner using R410A incurs pressure higher than when using conventional refrigerant, it is necessary to choose adequate materials.

Note:

Thicknesses of copper pipes used with R410A are as shown in the table.

Never use copper pipes thinner than those indicated in the table even if they are available on the market.

Thicknesses of Annealed Copper Pipes (R410A)

| Pipe outside diameter [mm (in.)] | Thickness [mm] |
|-------------------------------------|----------------|
| 6.35 (1/4) | 0.8 |
| 9.52 (3/8) | |
| 12.70 (1/2) | |
| 15.88 (5/8) | 1.0 |
| 19.05 (3/4) | 1.2 |

4.2. Protection of pipes

Protect the pipes to prevent the entry of moisture and dust.

Especially, pay attention when passing the pipes through a hole or connecting the end of a pipe to the outdoor unit.

| Location | Working period | Protection method |
|----------|-------------------|---------------------|
| Outdoor | 1 month or more | Pinch pipes |
| | Less than 1 month | Pinch or tape pipes |
| Indoor | - | Pinch or tape pipes |

4.3. Refrigerant pipe size and allowable piping length

⚠ CAUTION

Keep the piping length between the indoor unit and outdoor unit within the allowable tolerance.

4.3.1. Single type installation

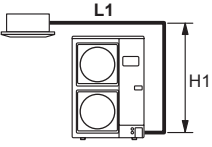
| Capacity [Btu/h class] | 36,000 | 45,000 | 54,000 |
|---|---|--------|--------|
| Pipe diameter <Liquid/Gas> (Standard) [mm (in.)] | 9.52 (3/8) / 15.88 (5/8) | | |
| Max. piping length (L1) [m] | 75 ^{*1} | | |
| Min. piping length (L1) [m] | 5 | | |
| Max. height difference (H1) <Indoor unit to outdoor unit> [m] | 30 | | |
| View (Example) |  | | |

*1: For the standard pipe diameter.

4.3.2. Simultaneous operation multi type installation

| CAUTION | |
|--|--|
| Be certain to install indoor units in the same room because the combinations are for simultaneous operation. | |
| The lengths after branching should be equal if possible. | |

Twin type

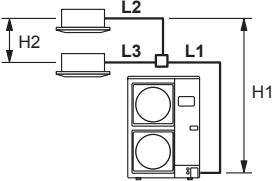
| Capacity [Btu/h class] | 36,000 | 45,000 | 54,000 |
|---|---|-----------------------------|--------------------|
| Indoor unit capacity [Btu/h class] | 18,000 + 18,000 | 22,000 + 22,000 | 24,000 + 24,000 |
| Main pipe diameter (L1) <Liquid/Gas> (Standard) [mm (in.)] | 9.52 (3/8) / 15.88 (5/8) | | |
| Branch pipe diameter (L2, L3) <Liquid/Gas> [mm (in.)] | 6.35 (1/4) / 12.70 (1/2) | 9.52 (3/8) / 15.88 (5/8) | |
| Max. piping length (L1+L2+L3) [m] | 75 ^{*1} | | |
| Min. piping length (L1+L2+L3) [m] | 5 | | |
| Max. branch piping length (L2, L3) [m] | 20 | | |
| Max. difference between branch lengths (L2 to L3) [m] | 8 | | |
| Max. height difference (H1) <Indoor unit to outdoor unit> [m] | 30 | | |
| Max. height difference (H2) <Indoor unit to indoor unit> [m] | 0.5 | | |
| View (Example) |  | | |

*1: For the standard pipe diameter.

Triple type

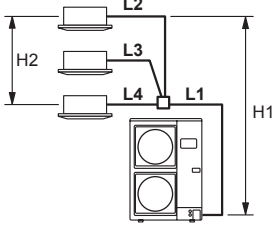
| Capacity [Btu/h class] | 54,000 | | | |
|---|---|--|--|--|
| Indoor unit capacity [Btu/h class] | 18,000 + 18,000 + 18,000 | | | |
| Main pipe diameter (L1) <Liquid/Gas> (Standard) [mm (in.)] | 9.52 (3/8) / 15.88 (5/8) | | | |
| Branch pipe diameter (L2, L3, L4) <Liquid/Gas> [mm (in.)] | 6.35 (1/4) / 12.70 (1/2) | | | |
| Max. piping length (L1+L2+L3+L4) [m] | 75 ^{*1} | | | |
| Min. piping length (L1+L2+L3+L4) [m] | 5 | | | |
| Max. branch piping length (L2, L3, L4) [m] | 20 | | | |
| Max. difference between branch lengths (L2 to L4) [m] | 8 | | | |
| Max. height difference (H1) <Indoor unit to outdoor unit> [m] | 30 | | | |
| Max. height difference (H2) <Indoor unit to indoor unit> [m] | 0.5 | | | |
| View (Example) |  | | | |

*1: For the standard pipe diameter.

4.4. Connectable pipe diameter and max. piping length

The figures enclosed by a thick-lined frame indicate the standard pipe diameter and max. piping length.

4.4.1. Single type installation

| Capacity [Btu/h class] | | 36,000 / 45,000 / 54,000 | | | |
|-----------------------------|--|--------------------------|-------------|-------------|-------------|
| Pipe diameter [mm (in.)] | Liquid pipes | 9.52 (3/8) | | 12.70 (1/2) | |
| | Gas pipes | 15.88 (5/8) | 19.05 (3/4) | 15.88 (5/8) | 19.05 (3/4) |
| Piping length [m (m)] | Max. piping length < L1 > ^{*1} (Pre-charge length) | 75 [30] | 50 [30] | 35 [15] | 35 [15] |

*1: Refer to "View" in the table of "4.3.1. Single type installation".

4.4.2. Simultaneous operation multi type installation

Twin type

| Capacity [Btu/h class] | | 36,000 | | | |
|-----------------------------|--|-------------|-----------------|-------------|-------------|
| Main piping [mm (in.)] | Liquid pipes | 9.52 (3/8) | | 12.70 (1/2) | |
| | Gas pipes | 15.88 (5/8) | 19.05 (3/4) | 15.88 (5/8) | 19.05 (3/4) |
| Branch piping [mm (in.)] | Liquid pipes | 6.35 (1/4) | | | |
| | Gas pipes | 12.70 (1/2) | | | |
| Piping length [m (m)] | Max. piping length < L1+L2+L3 > ^{*1} (Pre-charge length) | 75 [30] | 50 [30] | 35 [15] | 35 [15] |
| | Capacity [Btu/h class] | | 45,000 / 54,000 | | |
| Main piping [mm (in.)] | Liquid pipes | 9.52 (3/8) | | 12.70 (1/2) | |
| | Gas pipes | 15.88 (5/8) | 19.05 (3/4) | 15.88 (5/8) | 19.05 (3/4) |
| Branch piping [mm (in.)] | Liquid pipes | 9.52 (3/8) | | | |
| | Gas pipes | 15.88 (5/8) | | | |
| Piping length [m (m)] | Max. piping length < L1+L2+L3 > ^{*1} (Pre-charge length) | 75 [30] | 50 [30] | 35 [15] | 35 [15] |

*1: Refer to "View" in Twin type of 4.3.2. Simultaneous operation multi type installation.

Triple type

| Capacity [Btu/h class] | | 54,000 | | | |
|-----------------------------|---|-------------|-------------|-------------|-------------|
| Main piping [mm (in.)] | Liquid pipes | 9.52 (3/8) | | 12.70 (1/2) | |
| | Gas pipes | 15.88 (5/8) | 19.05 (3/4) | 15.88 (5/8) | 19.05 (3/4) |
| Branch piping [mm (in.)] | Liquid pipes | 6.35 (1/4) | | | |
| | Gas pipes | 12.70 (1/2) | | | |
| Piping length [m (m)] | Max. piping length < L1+L2+L3+L4 > ^{*1} (Pre-charge length) | 75 [30] | 50 [30] | 35 [15] | 35 [15] |

*1: Refer to "View" in Triple type of 4.3.2. Simultaneous operation multi type installation.

5. PIPE INSTALLATION-1

5.1. Opening a knock out hole

CAUTION

Be careful not to deform or scratch the panel while opening the knock out holes.

To protect the piping insulation after opening a knock out hole, remove any burrs from the edge of the hole. It is recommended to apply rust prevention paint to the edge of the hole.

- Pipes can be connected from 4 directions, front, lateral side, rear side and bottom. (Fig. A)
- When connecting at the bottom, remove the service panel and piping cover on the front of the outdoor unit, and open the knock out hole provided at the bottom corner of the piping outlet.
- It can be installed as shown on "Fig. B" cutting out the 2 slits as indicated on "Fig. C". (When cutting slits, use a steel saw.)

Fig. A

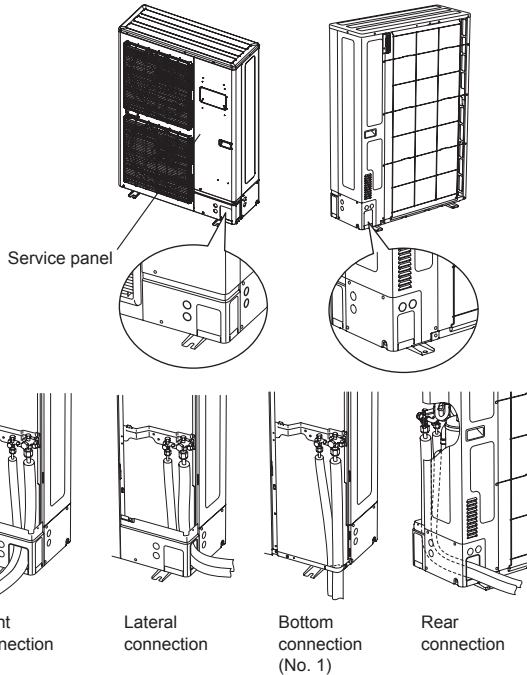

Fig. B

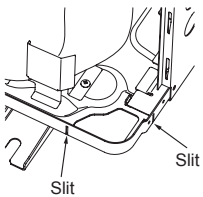
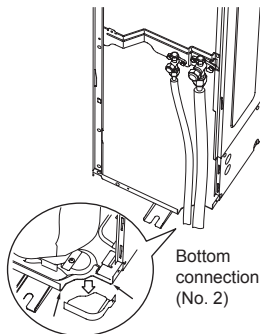

Fig. C



5.2. Brazing

CAUTION

If air or another type of refrigerant enters the refrigeration cycle, the internal pressure in the refrigeration cycle will become abnormally high and prevent the unit from exerting its full performance.

Apply nitrogen gas while brazing the pipes. If a pipe is brazed without applying nitrogen gas, an oxidation film will be created. This can degrade performance or damage the parts in the unit (such as the compressor or valves).

Nitrogen gas pressure: 0.02 MPa
(= pressure felt sufficiently on the back of the hand)

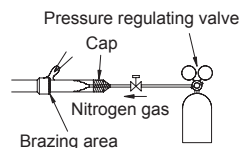

CAUTION

For brazing material, use phosphor copper that does not require flux. Do not use flux to braze pipes. If the flux is the chlorine type, it will cause the pipes to corrode. Furthermore, if the flux contains fluoride, it will adversely affect the refrigerant pipe system such as by degrading the refrigerant. If fluoride is contained, quality of refrigerant deteriorates and affects the refrigerant piping system.

5.3. Indoor unit pipe connections

5.3.1. Precautions for connecting simultaneous operation multi

CAUTION

Use genuine branch pipes for the refrigerant piping branches. Branch pipes are twin or triple type for concurrent operation, and may be used for piping between the outdoor and indoor units.

Select a twin or triple type branch pipe and purchase it before starting the installation work.

Shorten the length of branch pipes from a branch to indoor unit as short as possible. Maximum length: within 20 m.

Branch pipes shall be connected by welding (brazing).

Any vertical piping shall be in the part of the main piping. If a main pipe is bent, keep the straight part more than 10 times the diameter of the connected pipe. A variance in the amount of refrigerant may be caused if the straight part is short.

For details, refer to the Installation Manual of branch pipes.

5.3.2. Type of branch pipes

In case of a simultaneous operation multi (twin connection)

The liquid pipes and gas pipes shall be selected from the table below according to the diameter, and welded.

| Small pipe diameter | |
|---------------------|----------|
| Liquid pipe | Gas pipe |
| Large pipe diameter | |
| Liquid pipe | Gas pipe |

In case of a simultaneous operation multi (triple connection)

Weld the branch pipe shown at the left for liquid pipes, and the branch pipe shown at the right for gas pipes.

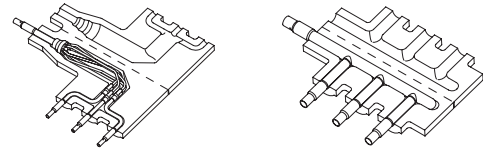

5.4. Flare connection (pipe connection)

CAUTION

Do not use mineral oil on a flared part. Prevent mineral oil from getting into the system as this would reduce the lifetime of the units.

While welding the pipes, be sure to blow dry nitrogen gas through them.

The maximum lengths of this product are shown in the table. If the units are further apart than this, correct operation cannot be guaranteed.

5.4.1. Flaring

Use special pipe cutter and flare tool exclusive for R410A.

- (1) Cut the connection pipe to the necessary length with a pipe cutter.
- (2) Hold the pipe downward so that the cuttings will not enter the pipe and remove any burrs.
- (3) Insert the flare nut (always use the flare nut attached to the indoor and outdoor units respectively) onto the pipe and perform the flare processing with a flare tool. Leakage of refrigerant may result if other flare nuts are used.
- (4) Protect the pipes by pinching them or with tape to prevent dust, dirt, or water from entering the pipes.

Check if [L] is flared uniformly and is not cracked or scratched.

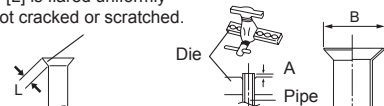

| Pipe outside diameter [mm (in.)] | Dimension A [mm] |
|-------------------------------------|-----------------------------------|
| | Flare tool for R410A, clutch type |
| 6.35 (1/4) | 0 to 0.5 |
| 9.52 (3/8) | |
| 12.70 (1/2) | |
| 15.88 (5/8) | |
| 19.05 (3/4) | |

| Pipe outside diameter [mm (in.)] | Dimension B _{0-0.4} [mm] |
|-------------------------------------|-----------------------------------|
| 6.35 (1/4) | 9.1 |
| 9.52 (3/8) | 13.2 |
| 12.70 (1/2) | 16.6 |
| 15.88 (5/8) | 19.7 |
| 19.05 (3/4) | 24.0 |

When using conventional flare tools to flare R410A pipes, the dimension A should be approximately 0.5 mm more than indicated in the table (for flaring with R410A flare tools) to achieve the specified flaring. Use a thickness gauge to measure the dimension A.

Width across flats



| Pipe outside diameter [mm (in.)] | Width across flats of Flare nut [mm] |
|----------------------------------|--------------------------------------|
| 6.35 (1/4) | 17 |
| 9.52 (3/8) | 22 |
| 12.70 (1/2) | 26 |
| 15.88 (5/8) | 29 |
| 19.05 (3/4) | 36 |

5.4.2. Bending pipes

CAUTION

To prevent breaking of the pipe, avoid sharp bends. Bend the pipe with a radius of curvature of 100 mm to 150 mm.

If the pipe is bent repeatedly at the same place, it will break.

- If pipes are shaped by hand, be careful not to collapse them.
- Do not bend the pipes at an angle of more than 90°.
- When pipes are repeatedly bent or stretched, the material will harden, making it difficult to bend or stretch them any more.
- Do not bend or stretch the pipes more than three times.

5.4.3. Pipe connection

CAUTION

Be sure to install the pipe against the port on the indoor unit and the outdoor unit correctly. If the centering is improper, the flare nut cannot be tightened smoothly. If the flare nut is forced to turn, the threads will be damaged.

Do not remove the flare nut from the outdoor unit pipe until immediately before connecting the connection pipe.

After installing the piping, make sure that the connection pipes do not touch the compressor or outer panel. If the pipes touch the compressor or outer panel, they will vibrate and produce noise.

- (1) Detach the caps and plugs from the pipes.
- (2) Center the pipe against the port on the outdoor unit, and then turn the flare nut by hand.
- (3) Tighten the flare nut of the connection pipe at the outdoor unit valve connector.

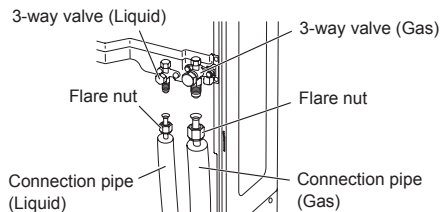

- (4) After tightening the flare nut by hand, use a torque wrench to fully tighten it.

CAUTION

Hold the torque wrench at its grip, keeping it in a right angle with the pipe, in order to tighten the flare nut correctly.

- Outer panel may be distorted if fastened only with a wrench. Be sure to fix the elementary part with a spanner and fasten with a wrench (refer to below diagram).
- Do not apply force to the blank cap of the valve or hang a wrench, etc., on the cap. It may cause leakage of refrigerant.

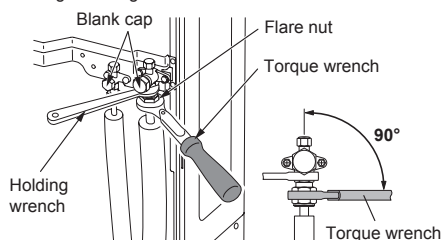

| Flare nut [mm (in.)] | Tightening torque [N·m (kgf·cm)] |
|----------------------|----------------------------------|
| 6.35 (1/4) dia. | 16 to 18 (160 to 180) |
| 9.52 (3/8) dia. | 32 to 42 (320 to 420) |
| 12.70 (1/2) dia. | 49 to 61 (490 to 610) |
| 15.88 (5/8) dia. | 63 to 75 (630 to 750) |
| 19.05 (3/4) dia. | 90 to 110 (900 to 1100) |

5.4.4. Handling precautions for the valves

- Mounted part of Blank cap is sealed for protection.
- Fasten blank cap tightly after opening valves.

Table A

| Blank cap [mm (in.)] | Tightening torque [N·m (kgf·cm)] |
|----------------------|----------------------------------|
| 6.35 (1/4) | 20 to 25 (200 to 250) |
| 9.52 (3/8) | 20 to 25 (200 to 250) |
| 12.70 (1/2) | 25 to 30 (250 to 300) |
| 15.88 (5/8) | 30 to 35 (300 to 350) |
| 19.05 (3/4) | 35 to 40 (350 to 400) |

Operating the valves

- Use a hexagon wrench (size 4 mm).
- Opening
 - (1) Insert the hexagon wrench into the valve shaft, and turn it counterclockwise.
 - (2) Stop turning when the valve shaft can no longer be turned. (Open position)
- Closing
 - (1) Insert the hexagon wrench into the valve shaft, and turn it clockwise.
 - (2) Stop turning when the valve shaft can no longer be turned. (Closed position)

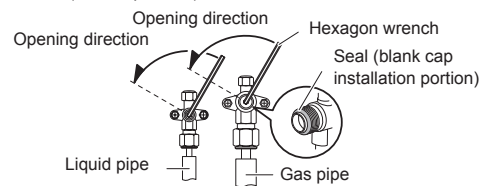

5.5. Sealing test

WARNING

Before operating the compressor, install the pipes and securely connect them. Otherwise, if the pipes are not installed and if the valves are open when the compressor operates, air could enter the refrigeration cycle. If this happens, the pressure in the refrigeration cycle will become abnormally high and cause damage or injury.

After the installation, make sure there is no refrigerant leakage. If the refrigerant leaks into the room and becomes exposed to a source of fire such as a fan heater, stove, or burner, it produces a toxic gas.

Do not subject the pipes to strong shocks during the sealing test. It can rupture the pipes and cause serious injury.

CAUTION

Do not block the walls and the ceiling until the sealing test and the charging of the refrigerant gas have been completed.

For maintenance purposes, do not bury the piping of the outdoor unit.

- After connecting the pipes, perform a sealing test.
- Make sure that the 3-way valves are closed before performing a sealing test.
- Pressurize nitrogen gas to 4.15 MPa to perform the sealing test.
- Add nitrogen gas to both the liquid pipes and the gas pipes.
- Check all flare connections and welds. Then, check that the pressure has not decreased.
- Compare the pressures after pressurizing and letting it stand for 24 hours, and check that the pressure has not decreased.
 - * When the outdoor air temperature changes 5 °C, the test pressure changes 0.05 MPa. If the pressure has dropped, the pipe joints may be leaking.
- If a leak is found, immediately repair it and perform the sealing test again.
- After completing the sealing test, release the nitrogen gas from both valves.
- Release the nitrogen gas slowly.

5.6. Vacuum process

CAUTION

Perform a refrigerant leakage test (air tightness test) to check for leaks using nitrogen gas while all valves in the outdoor unit are closed. (Use the test pressure indicated on the nameplate.)

Be sure to evacuate the refrigerant system using a vacuum pump.

The refrigerant pressure may sometimes not rise when a closed valve is opened after the system is evacuated using a vacuum pump. This is caused by the closure of the refrigerant system of the outdoor unit by the electronic expansion valve. This will not affect the operation of the unit.

If the system is not evacuated sufficiently, its performance will drop.

CAUTION

Use a clean gauge manifold and charging hose that were designed specifically for use with R410A. Using the same vacuum equipment for different refrigerants may damage the vacuum pump or the unit.

Do not purge the air with refrigerants, but use a vacuum pump to evacuate the system.

- (1) Check that the valves are closed by removing the blank caps from the gas and liquid pipes.
- (2) Remove the charging port cap, and connect the gauge manifold and the vacuum pump to the charging valve with the service hoses.
- (3) Vacuum the indoor unit and the connecting pipes until the pressure gauge indicates -0.1 MPa (-76 cmHg).
- (4) When -0.1 MPa (-76 cmHg) is reached, operate the vacuum pump for at least 60 minutes.
- (5) Disconnect the service hoses and fit the charging port cap to the charging valve to the specified torque. (Refer to below table)
- (6) Remove the blank caps, and fully open the 3-way valves with a hexagon wrench [Torque: 6 to 7 N·m (60 to 70 kgf·cm)].
- (7) Tighten the blank caps of the 3-way valve to the specified torque. (Refer to Table A on page 8.)

| | Tightening torque [N·m (kgf·cm)] |
|-------------------|----------------------------------|
| Charging port cap | 10 to 12 (100 to 120) |

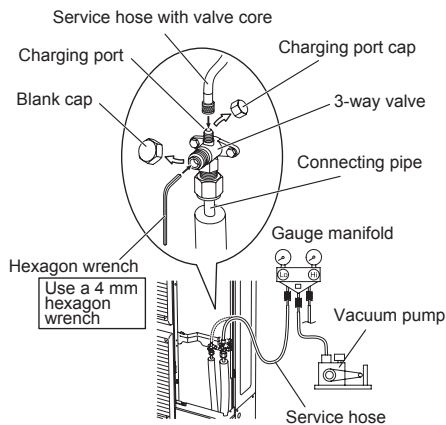

Single type

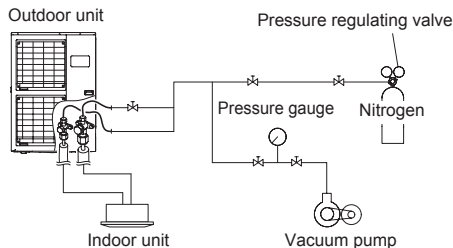

Simultaneous operation multi type

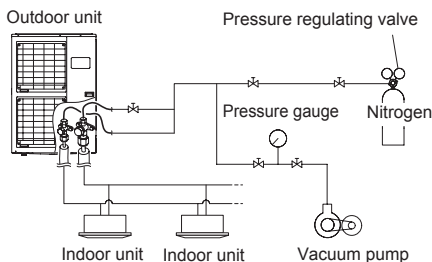

5.7. Additional charging

CAUTION

After vacuuming the system, add refrigerant.

Do not reuse recovered refrigerant.

When charging the refrigerant R410A, always use an electronic scales for refrigerant charging (to measure the refrigerant by weight). Adding more refrigerant than the specified amount will cause a malfunction.

When charging the refrigerant, take into account the slight change in the composition of the gas and liquid phases, and always charge from the liquid phase side whose composition is stable. Adding refrigerant through the gas pipe will cause a malfunction.

Check if the steel cylinder has a siphon installed or not before filling. (There is an indication "with siphon for filling liquid" on the steel cylinder.)

Filling method for cylinder with siphon

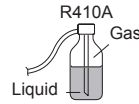

Set the cylinder vertical and fill with the liquid. (Liquid can be filled without turning bottom up with the siphon inside.)

Filling method for other cylinders

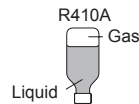

Turn bottom up and fill with liquid. (Be careful to avoid turning over the cylinder.)

Be sure to use the special tools for R410A for pressure resistance and to avoid mixing of impure substances.

If the units are further apart than the maximum pipe length, correct operation can not be guaranteed.

Make sure to back closing valve after refrigerant charging. Otherwise, the compressor may fail.

Minimize refrigerant release to the air. Excessive release is prohibited under the Freon Collection and Destruction Law.

5.7.1. For Pre-charge length

| Refrigerant pipe size | Piping length (L) *Pre-Charge [m] |
|-----------------------|-----------------------------------|
| Standard | 30 |
| Size up (Liquid pipe) | 15 |

5.7.2. If additional refrigerant is required

- When the piping is longer than Pre-charge length, additional charging is necessary.
- For the additional amount, see the table below.

Additional charging amount

Single type

L1 (*1) > Pre-charge length

| | Refrigerant pipe size [mm (in.)] | Piping length | | | | | | g/m |
|----------|----------------------------------|---------------|---------|---------|---------|---------|---------|-----|
| | | ~30 m | 40 m | 50 m | 60 m | 70 m | | |
| Standard | Liquid 9.52 (3/8) | None | 500 g | 1,000 g | 1,500 g | 2,000 g | 50 g/m | |
| | Gas 15.88 (5/8) | None | 500 g | 1,000 g | 1,500 g | 2,000 g | 50 g/m | |
| Size up | Liquid 9.52 (3/8) | ~30 m | 40 m | 50 m | | | g/m | |
| | Gas 19.05 (3/4) | None | 500 g | 1,000 g | | | 50 g/m | |
| | Liquid 12.70 (1/2) | ~15 m | 25 m | 35 m | | | g/m | |
| | Gas 15.88 (5/8) 19.05 (3/4) | None | 1,000 g | 2,000 g | | | 100 g/m | |

*1: Refer to "View" in the table of "4.3.1. Single type installation".

Simultaneous operation multi type

Twin : L1+L2+L3 (*2) > Pre-charge length

Triple : L1+L2+L3+L4 (*3) > Pre-charge length

*2 : Refer to "View" in the table of "4.3.2. Simultaneous operation multi type installation."

*3 : Refer to "View" in the table of "4.3.2. Simultaneous operation multi type installation."

The additional charging amount for twin / triple type will be calculated as follows:

$$\text{Additional charging amount (g)} = (A \times 100) + (B \times 50) + (C \times 30) - 1,500$$

- A = Piping length (m) of liquid pipe [12.70 mm (1/2 in.)]
- B = Piping length (m) of liquid pipe [9.52 mm (3/8 in.)]
- C = Piping length (m) of liquid pipe [6.35 mm (1/4 in.)]

Do not remove refrigerant, even if the additional amount calculated is negative.

(Example 1)

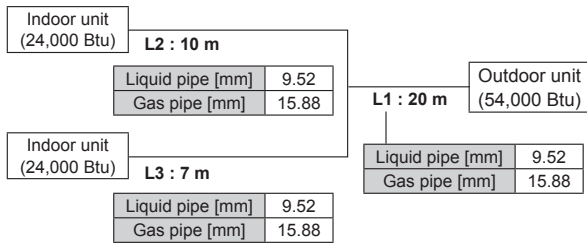

Additional charging amount

| Liquid pipe diameter [mm] | Piping length [m] | Coefficient |
|---------------------------|-------------------|-------------|
| 12.70 | 0 | A = 0 |
| 9.52 | 37 | B = 37 |
| 6.35 | 0 | C = 0 |

Applying the formula,
 $(0 \times 100) + (37 \times 50) + (0 \times 30) - 1500 = 350$
 The additional charging amount is 350 g.

(Example 2)

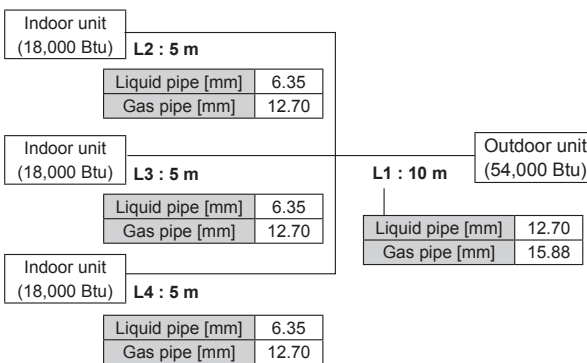

Additional charging amount

| Liquid pipe diameter [mm] | Piping length [m] | Coefficient |
|---------------------------|-------------------|-------------|
| 12.70 | 10 | A = 10 |
| 9.52 | 0 | B = 0 |
| 6.35 | 15 | C = 15 |

Applying to the formula,
 $(10 \times 100) + (0 \times 50) + (15 \times 30) - 1500 = -50$
 The calculated value is negative. Do not add or remove any refrigerant.

6. ELECTRICAL WIRING

6.1. Notes for electrical wiring

⚠ WARNING

Wiring connections must be performed by a qualified person in accordance with the specifications. The voltage rating for this product is 400 V at 50 Hz. It should be operated within the range of 342 to 456 V.

Before connecting the wires, make sure the power supply is OFF.

Use a dedicated power supply circuit. Insufficient power capacity in the electrical circuit or improper wiring may cause electric shock or fire.

Install a breaker at the power supply for each outdoor unit. Improper breaker selection can cause electric shock or fire.

Install a leakage circuit breaker in accordance with the related laws and regulations. An improperly installed electrical box cover can cause serious accidents such as electric shock or fire through exposure to dust or water.

A circuit breaker is installed in the permanent wiring. Always use a circuit that can trip all the poles of the wiring and has an isolation distance of at least 3 mm between the contacts of each pole.

Use designated cables and power cables. Improper use may cause electric shock or fire by poor connection, insufficient insulation, or over current.

Do not modify power cable, use extension cable or branch wiring. Improper use may cause electric shock or fire by poor connection, insufficient insulation or over current.

Connect the connector cable securely to the terminal. Check no mechanical force bears on the cables connected to the terminals. Faulty installation can cause a fire.

Use crimp-type terminals and tighten the terminal screws to the specified torques, otherwise, abnormal overheating may be produced and possibly cause serious damage inside the unit.

⚠ WARNING

Make sure to secure the insulation portion of the connector cable with the cable clamp. Damaged insulation can cause a short circuit.

Fix cables so that cables do not make contact with the pipes (especially on high pressure side). Do not make power supply cable and transmission cable come in contact with valves (Gas).

Never install a power factor improvement condenser. Instead of improving the power factor, the condenser may overheat.

Be sure to perform the earthing (grounding) work. Do not connect earthing (grounding) wires to a gas pipe, water pipe, lightning rod or earthing (grounding) wire for a telephone.

- Connection to a gas pipe may cause a fire or explosion if gas leaks.
- Connection to a water pipe is not an effective earthing (grounding) method if PVC pipe is used.
- Connection to the earthing (grounding) wire of a telephone or to a lightning rod may cause a dangerously abnormal rise in the electrical potential if lightning strikes. Improper earthing (grounding) work can cause electric shocks.

Securely install the electrical box cover on the unit. An improperly installed service panel can cause serious accidents such as electric shock or fire through exposure to dust or water.

⚠ CAUTION

The primary power supply capacity is for the air conditioner itself, and does not include the concurrent use of other devices.

Do not start operation until the refrigerant is charged completely. The compressor will fail if it is operated before the refrigerant piping charging is complete.

Transmission cable between indoor unit and outdoor unit is 230 V.

Be sure not to remove thermistor sensor etc. from power wiring and connection wiring. Compressor may fail if operated while removed.

Start wiring work after closing branch switch and over current breaker.

Use an earth leakage breaker that is capable of handling high frequencies. Because the outdoor unit is inverter controlled, a high-frequency earth leakage breaker is necessary to prevent a malfunction of the breaker itself.

When using an earth leakage breaker that has been designed solely for earth (ground) fault protection, be sure to install a fuse-equipped switch or circuit breaker.

Do not connect the AC power supply to the transmission line terminal board. Improper wiring can damage the entire system.

Do not use crossover power supply wiring for the outdoor unit.

If the temperature surrounding the breaker is too high, the amperage at which the breaker cuts out may decrease.

How to connect wiring to the terminal

Caution when wiring cable

When stripping off the coating of a lead wire, always use a special tool such as a wire stripper. If there is no special tool available, carefully strip the coating with a knife etc.

- (1) Use crimp-type terminals with insulating sleeves as shown in the figure below to connect to the terminal block.
- (2) Securely clamp the crimp-type terminals to the wires using an appropriate tool so that the wires do not come loose.

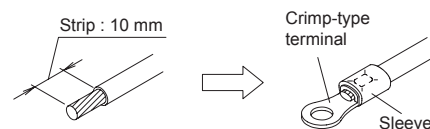

- (3) Use the specified wires, connect them securely, and fasten them so that there is no stress placed on the terminals.
- (4) Use an appropriate screwdriver to tighten the terminal screws. Do not use a screwdriver that is too small, otherwise, the screw heads may be damaged and prevent the screws from being properly tightened.
- (5) Do not tighten the terminal screws too much, otherwise, the screws may break.

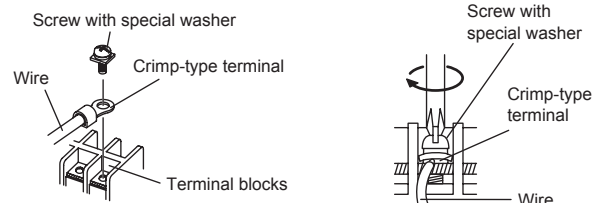

- (6) See the table below for the terminal screw tightening torques.

| Tightening torque [N·m (kgf·cm)] | |
|----------------------------------|-----------------------|
| M4 screw | 1.2 to 1.8 (12 to 18) |
| M5 screw | 2.0 to 3.0 (20 to 30) |

6.2. Selecting circuit breaker and wiring

CAUTION

Be sure to install a breaker with specified capacity.

Before the electrical working, confirm electrical standards and regulations in each country, region, or installing place. Then select appropriate cables and breakers that comply with them.

Decide the diameter of wire referring to below table "Breaker and wiring specifications" in accordance with local and national codes.

Breaker and wiring specifications

| Breaker capacity [A] | Power supply cable | Transmission cable* | |
|----------------------|-----------------------------------|-----------------------------------|-----------------|
| | Conductor size [mm ²] | Conductor size [mm ²] | Max. length [m] |
| 16 | 2.5 (Min.) | 1.5 (Min.) | 75 |

*: If the transmission wire is longer than 50 m, use the bigger conductor size.

- Max. wire length: Set a length so that the voltage drop is less than 2%. Increase the wire diameter when the wire length is long.
- Use confirmed cable with type 60245 IEC 57.
- Install a circuit breaker with a contact gap of at least 3 mm in all poles nearby the units. (Both indoor units and outdoor units)

6.3. Knock out holes for wiring

CAUTION

Be careful not to deform or scratch the panel while opening the knock out holes.

When cables are routed from the unit, a protection sleeve for the conduits can be inserted at the knock out hole.

If you do not use a wire conduit, be sure to protect the wires to prevent the edge of the knock out hole from cutting the wires.

It is recommended to apply anti-rust paint to the edge of the knock out hole.

- Knock out holes are provided for wiring. (Fig. A)
- Knock out holes are provided 2 each in the same size in front, lateral and rear sides. (Fig. B)

Fig. A

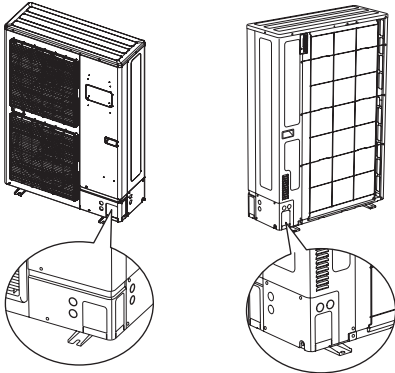
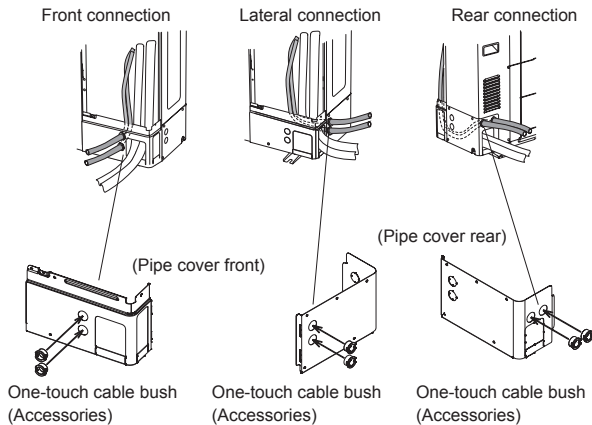

Fig. B

Installation method of One-touch bush

Please fix the One-touch bush (accessory) as shown in the figure below.



Note : Please ensure that the power cable and interconnecting cables are not installed through the same cable bush hole opening. They must be installed into the two separate hole openings to prevent damage to the cable.

6.4. Wiring method

6.4.1. Connection diagrams

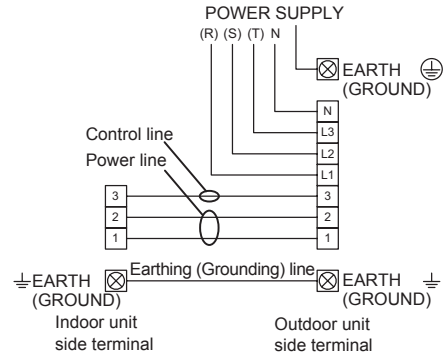

6.4.2. Connection cable preparation

Keep the earth (ground) wire longer than the other wires.

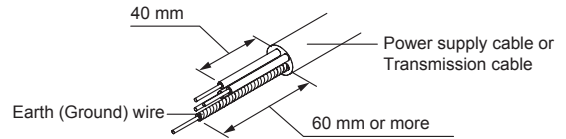

6.4.3. Wiring procedure

- (1) Remove the service panel cover, insulation sheet and connect the wires to the terminal in accordance with the terminal nameplate. (Fig. A, Fig. B)

Fig. A

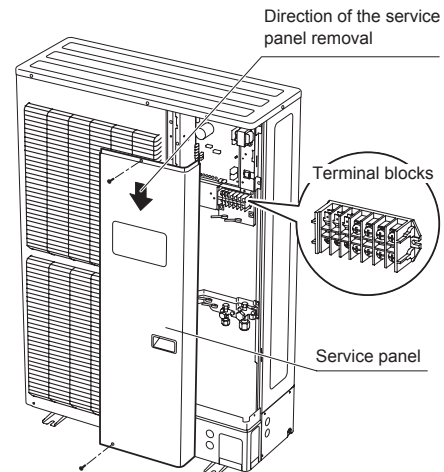

- (2) After connecting the wires, use cable clips to secure the wires. (Fig. B)
 - Connect the wires without applying excessive tension.

Fig. B

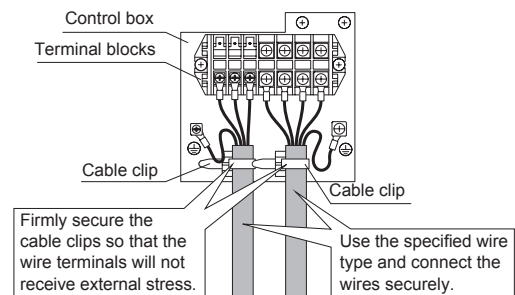

- (3) Secure the cables using the cable clips under the terminal blocks, and then secure the cables using the cable clips attached to the base of the valves.

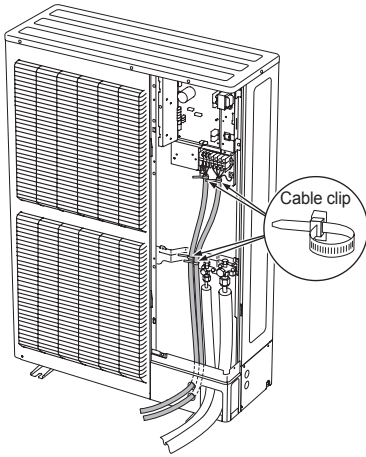

- (4) Be sure to install the insulation sheet after the wiring is complete.

7. PIPE INSTALLATION-2

⚠ WARNING

Install the insulated pipes so that they do not touch the compressor.

7.1. Installing insulation

- Use an insulation on the refrigerant pipes to prevent condensation and dripping. (Fig. A)
- Determine the thickness of the insulation material by referring to Table A.

Table A, Selection of insulation
(for using an insulation material with equal heat transmission rate or below 0.040 W/(m·k))

| Relative humidity [mm (in.)] | | Insulation material | | | |
|---------------------------------|-------------|------------------------|----------------|----------------|----------------|
| | | Minimum thickness [mm] | | | |
| | | 70% or more | 75% or more | 80% or more | 85% or more |
| Pipe diameter | 6.35 (1/4) | 8 | 10 | 13 | 17 |
| | 9.52 (3/8) | 9 | 11 | 14 | 18 |
| | 12.70 (1/2) | 10 | 12 | 15 | 19 |
| | 15.88 (5/8) | 10 | 12 | 16 | 20 |
| | 19.05 (3/4) | 10 | 13 | 16 | 21 |

If the ambient temperature and relative humidity exceed 32 °C, increase the level of heat insulation for the refrigerant pipes.

7.2. Filling with putty

⚠ WARNING

Fill the piping holes with putty (supplied locally) to avoid any gap (Fig A). If small animals such as insects enter the external unit, a short circuit may be caused near electrical components in the service panel.

If the outdoor unit is installed at a level that is higher than the indoor unit, the water that has condensed in the 3-way valve of the outdoor unit could travel to the indoor unit. Therefore, use putty in the space between the pipe and the insulation to prevent the entry of water.

Fig. A

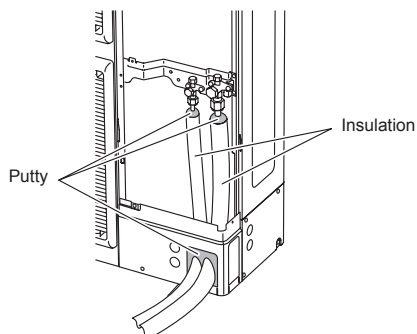

8. HOW TO OPERATE DISPLAY UNIT

8.1. Various setting methods

⚠ WARNING

Never touch electrical components such as the terminal blocks or reactor except the switch on the display board. It may cause a serious accident such as electric shock.

⚠ CAUTION

Once refrigerant charging is completed, be sure to open the valve prior to performing the local settings. Otherwise, the compressor may fail.

Discharge any static electricity from your body before touching the push switches. Never touch any terminal or pattern of any parts on the control board.

- The positions of the switches on the outdoor unit control board are shown in the figure below.

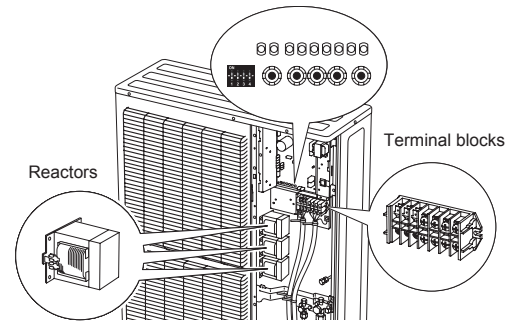

- Various settings can be adjusted by changing DIP switches and push switches on the board of the outdoor unit.

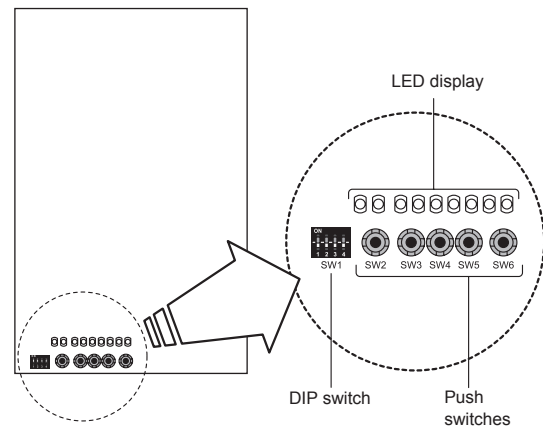

- The printed characters for the LED display are shown below.

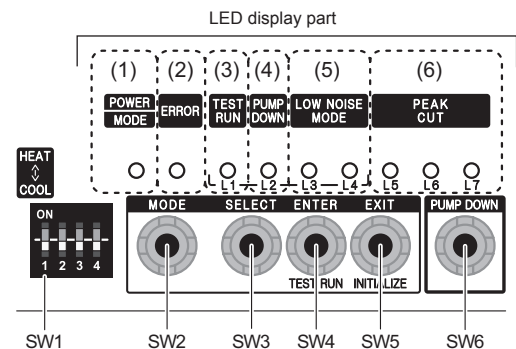

8.2. Description of display

| Display lamp | | Function or operation method |
|-----------------------------|--------|---|
| (1) POWER/MODE | Green | Lights on while power on Local setting in outdoor unit or error code is displayed with blink. |
| (2) ERROR | Red | Blinks during abnormal air-conditioner operation. |
| (3) TEST RUN (L1) | Orange | Lights on during test operation. |
| (4) PUMP DOWN (L2) | Orange | Lights on during pump down operation. |
| (5) LOW NOISE MODE (L3, L4) | Orange | Lights on during "Low noise" function when local setting is activated. (Lighting pattern of L3 and L4 indicates low noise level) ⇒ Refer to "9. LOCAL SETTING". |
| (6) PEAK CUT (L5, L6, L7) | Orange | Lights on during "Peak cut" function when local setting is activated. (Lighting pattern of L5, L6 and L7 indicates peak cut level) ⇒ Refer to "9. LOCAL SETTING". |

| Switch | | Function or operation method |
|--------|-------------|--|
| SW1 | DIP switch | For selecting cooling or heating during test operation. Positions 2 to 4 of DIP switch are not used. |
| SW2 | Push switch | To switch between "Local setting" and "Error code display". |
| SW3 | Push switch | To switch between the individual "Local settings" and the "Error code displays". |
| SW4 | Push switch | To fix the individual "Local settings", "Test run" and the "Error code displays". |
| SW5 | Push switch | EXIT |
| SW6 | Push switch | To start the pump down operation. |

• DIP switches 1 to 4 at shipment from the factory are set as follows.

| DIP switch | | | |
|------------|-----|-----|-----|
| 1 | 2 | 3 | 4 |
| COOL | OFF | OFF | OFF |

9. LOCAL SETTING

⚠ CAUTION

Discharge the static electricity from your body before setting up the switches. Never touch the terminals or the patterns on the parts that are mounted on the board.

9.1. Low noise mode (Local work)

Outdoor unit may be operated with lower noise than normal operation when following below local work.

• Low noise operation is available by installation of an additional commercially available timer or contact input from the ON-OFF switch to the CN19 connector (an external contact input sold separately) on the control board of the outdoor unit.

* Performance may be deficient depending on outdoor temperature or conditions etc.

< Example of circuit diagram >

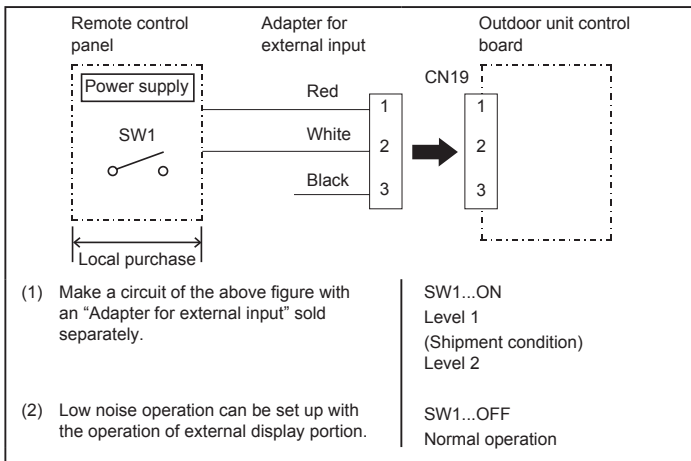

9.1.1. Setting for low noise

LED display part

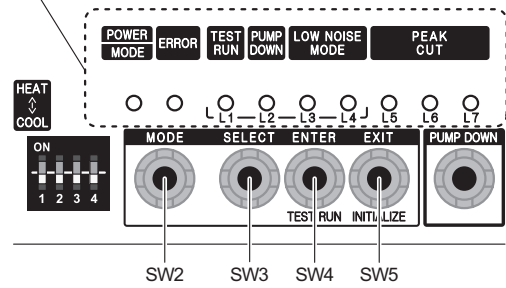

- Switch to "Local setting mode" by pressing **MODE** switch (SW2) for 3 seconds or more.
- Confirm POWER/MODE LED blinks 9 times, and press **ENTER** switch (SW4).

| POWER/MODE | ERROR | TEST RUN (L1) | PUMP DOWN (L2) | LOW NOISE (L3) (L4) | PEAK CUT (L5) (L6) (L7) |
|------------------|-------|---------------|----------------|---------------------|-------------------------|
| Blinks (9 times) | ○ | ○ | ○ | ○ | ○ |

Sign "○": Lights off

- Press **SELECT** switch (SW3), and adjust LED display as shown below. (Current setting is displayed)

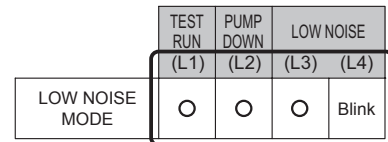

- Press **ENTER** switch (SW4).

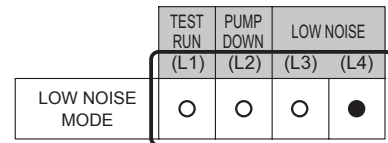

Sign "●": Lights on

- Press **SELECT** switch (SW3), and adjust LED display as shown in below figure.

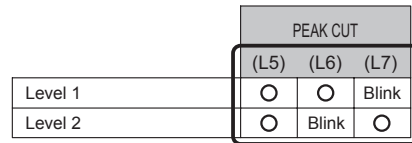

- Press **ENTER** switch (SW4) and fix it.

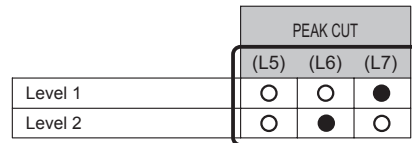

- Return to "Operating status display (Normal operation)" by pressing **EXIT** switch (SW5).

In case of missing how many times **SELECT** and **ENTER** switch are pressed, restart from the beginning of operation procedure after returning to "Operation status display (normal operation)" by pressing the **EXIT** switch once.

9.2. Peak cut mode (Local work)

Efficient operation while reducing power supply and power consumption with below local work.

- Peak cut function can be effective with contact installation of an additional ON-OFF switch to the CN19 connector on the outdoor control board.

< Example of circuit diagram >

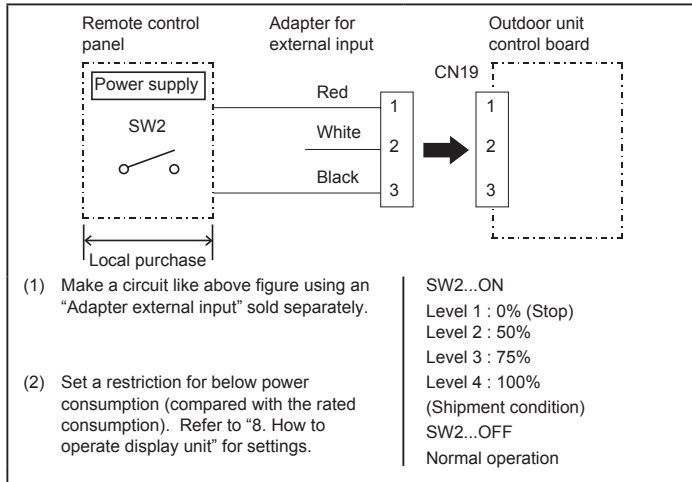

9.2.1. Setting for peak cut

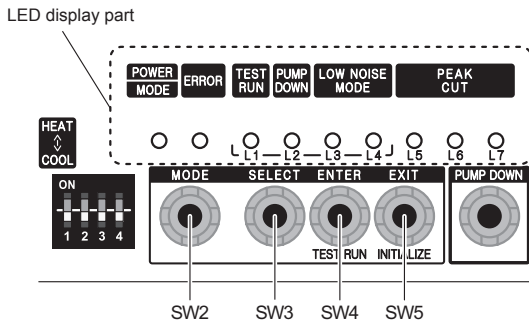

- Switch to "Local setting mode" by pressing **MODE** switch (SW2) for 3 seconds or more.
- Confirm **POWER/MODE** LED blinks 9 times, and press **ENTER** switch (SW4).

| POWER MODE | ERROR | TEST RUN (L1) | PUMP DOWN (L2) | LOW NOISE (L3) (L4) | PEAK CUT (L5) (L6) (L7) | | |
|------------------|-------|---------------|----------------|---------------------|-------------------------|---|---|
| Blinks (9 times) | ○ | ○ | ○ | ○ | ○ | ○ | ○ |

Sign "○" : Lights off

- Press **SELECT** switch (SW3), and adjust LED display as shown below. (Current setting is displayed)

| PEAK CUT MODE | TEST RUN (L1) | PUMP DOWN (L2) | LOW NOISE (L3) (L4) |
|---------------|---------------|----------------|---------------------|
| | ○ | ○ | Blink |

- Press **ENTER** switch (SW4).

| PEAK CUT MODE | TEST RUN (L1) | PUMP DOWN (L2) | LOW NOISE (L3) (L4) |
|---------------|---------------|----------------|---------------------|
| | ○ | ○ | ● |

Sign "●" : Lights on

- Press **SELECT** switch (SW3), and adjust LED display as shown in below figure.

| | PEAK CUT | | |
|---------------------------|----------|-------|-------|
| | (L5) | (L6) | (L7) |
| 0% of rated input ratio | ○ | ○ | Blink |
| 50% of rated input ratio | ○ | Blink | ○ |
| 75% of rated input ratio | ○ | Blink | Blink |
| 100% of rated input ratio | Blink | ○ | ○ |

- Press **ENTER** switch (SW4) and fix it.

| | PEAK CUT | | |
|---------------------------|----------|------|------|
| | (L5) | (L6) | (L7) |
| 0% of rated input ratio | ○ | ○ | ● |
| 50% of rated input ratio | ○ | ● | ○ |
| 75% of rated input ratio | ○ | ● | ● |
| 100% of rated input ratio | ● | ○ | ○ |

- Return to "Operating status display (Normal operation)" by pressing **EXIT** switch (SW5).

When pressed number is lost during operation, restart from the beginning of operation procedure after returning to "Operation status display (normal operation)" by pressing the **EXIT** switch once.

10. TEST RUN

CAUTION

Always turn on the power 6 hours prior to the start of the operation in order to protect the compressor.

10.1. Check items before performing the test run

- Make sure to perform the test run.
- Before performing the test run, be sure to check the following points.
 - Is gas leaking?
 - Check connection of each pipe (flare connection part, brazing part).
 - Is a breaker installed to the power cable of the outdoor unit?
 - Has each cable been securely connected to the terminal according to the specifications?
 - Are the 3-way valves (gas pipes and liquid pipes) of the outdoor units open?
 - Has the power been supplied to the unit for at least 6 hours?
 - Has the necessary local setting been done?
 - Check insulation resistance of 1 MΩ or more using a 500 V mega tester.
- If no problems are found with the above items, perform the test run according to "Test run method".
- If any problems are found, immediately resolve the problem and re-check the items.

10.2. Test run method

CAUTION

If the test run is performed for 1 outdoor unit in a group control system installation, the test run will also be performed for the other units. Therefore, make sure that all of the units have been installed before starting a test run. (Group control system installation described in "SPECIAL INSTALLATION METHODS" in the installation manual of the indoor unit.)

- Operate **ENTER** (TEST RUN) switch on the display board by the following procedure.

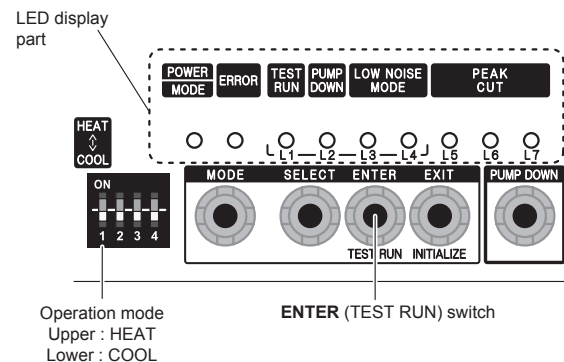

10.2.1. Operating procedures for the test run

- Check the 3-way valves (both at the liquid side and gas side) are opened.
- Set the operation mode to "COOL" or "HEAT".

| POWER MODE | ERROR | TEST RUN (L1) | PUMP DOWN (L2) | LOW NOISE (L3) (L4) | PEAK CUT (L5) (L6) (L7) | | |
|------------|-------|---------------|----------------|---------------------|-------------------------|---|---|
| ● | ○ | ○ | ○ | ○ | ○ | ○ | ○ |

- In the first test run, be sure to set the operation mode to "COOL".
- The operation mode cannot be switched between "COOL" and "HEAT" during the test run. To switch the operation mode between "COOL" and "HEAT", stop the test run, switch the operation mode, and then start the test run again.

(3) Press **ENTER** (TEST RUN) switch for more than 3 seconds.

| POWER | ERROR | TEST RUN (L1) | PUMP DOWN (L2) | LOW NOISE (L3) (L4) | | PEAK CUT (L5) (L6) (L7) | | |
|-------|-------|---------------|----------------|---------------------|---|-------------------------|---|---|
| MODE | | | | | | | | |
| ● | ○ | ● | ○ | ○ | ○ | ○ | ○ | ○ |

TEST RUN LED will light on.

- If the compressor is operating at starting the test run, the compressor will stop and, after a while, the test run will start.
- Either of the above LOW NOISE or PEAK CUT LED will light on during the test run if local setting function is selected.

(4) Confirm operating status.

(5) Press **ENTER** (TEST RUN) switch again.

| POWER | ERROR | TEST RUN (L1) | PUMP DOWN (L2) | LOW NOISE (L3) (L4) | | PEAK CUT (L5) (L6) (L7) | | |
|-------|-------|---------------|----------------|---------------------|---|-------------------------|---|---|
| MODE | | | | | | | | |
| ● | ○ | ○ | ○ | ○ | ○ | ○ | ○ | ○ |

TEST RUN LED lights off, and TEST RUN stops.

- Test run will finish after about 60 minutes automatically. At the same time, TEST RUN LED will light off.
- Test run may be stopped before operating for 60 minutes if an error occurs after a starting test run.

11. PUMP DOWN

⚠ WARNING

Never touch electrical components such as the terminal blocks or reactor except the switch on the display board. It may cause a serious accident such as electric shock.

⚠ CAUTION

Perform the pump down operation before disconnecting any refrigerant pipe or electric cable.

Collect refrigerant from the service port or the 3-way valve if pump down cannot be performed.

In case of a group control system installation, do not turn the power off pump down is completed in all outdoor units.
(Group control system installation described in "SPECIAL INSTALLATION METHODS" in the installation manual of the indoor unit.)

Operate **PUMP DOWN** switch on the display board in the manner described below.

LED display part

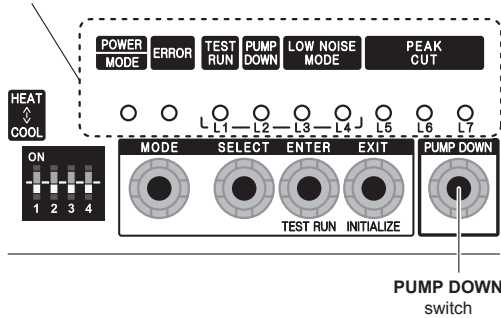

PUMP DOWN switch

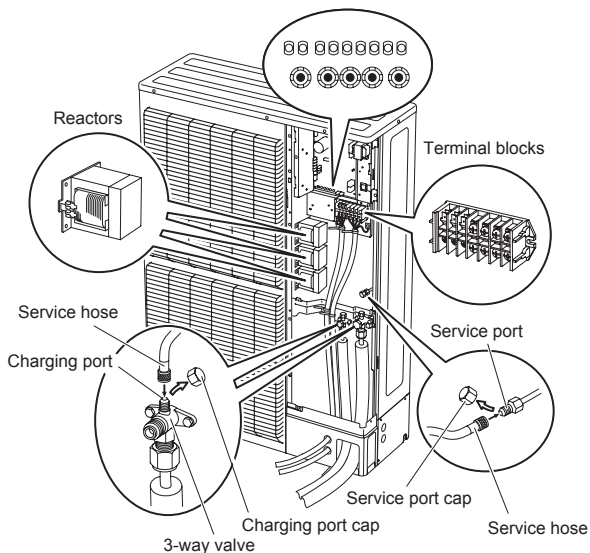

11.1. Preparation for pump down

Confirm that the power is off, and then open the service panel.

11.2. Pump down procedure

- (1) Check the 3-way valves (both at the liquid side and gas side) are opened.
- (2) Turn the power on.

| POWER | ERROR | TEST RUN (L1) | PUMP DOWN (L2) | LOW NOISE (L3) (L4) | | PEAK CUT (L5) (L6) (L7) | | |
|-------|-------|---------------|----------------|---------------------|---|-------------------------|---|---|
| MODE | | | | | | | | |
| ● | ○ | ○ | ○ | ○ | ○ | ○ | ○ | ○ |

- (3) Press **PUMP DOWN** switch for 3 seconds or more after 3 minutes after power on.

| POWER | ERROR | TEST RUN (L1) | PUMP DOWN (L2) | LOW NOISE (L3) (L4) | | PEAK CUT (L5) (L6) (L7) | | |
|-------|-------|---------------|----------------|---------------------|---|-------------------------|---|---|
| MODE | | | | | | | | |
| ● | ○ | ○ | ● | ○ | ○ | ○ | ○ | ○ |

LED display lights on as shown in the above figure, and the fans and the compressor start operating.

- (4) LED display will change as shown below about 3 minutes after the compressor starts. Fully close the 3-way valve on the liquid pipe side at this stage.

| POWER | ERROR | TEST RUN (L1) | PUMP DOWN (L2) | LOW NOISE (L3) (L4) | | PEAK CUT (L5) (L6) (L7) | | |
|-------|-------|---------------|----------------|---------------------|---|-------------------------|---|---|
| MODE | | | | | | | | |
| ● | ○ | ○ | ● | ○ | ○ | ○ | ● | ○ |

- If the valve on the liquid pipe side is not closed, the pump down cannot be performed.
- (5) When LED display changes as shown in the below figure, close the 3-way valve on the gas pipe side tightly.

| POWER | ERROR | TEST RUN (L1) | PUMP DOWN (L2) | LOW NOISE (L3) (L4) | | PEAK CUT (L5) (L6) (L7) | | |
|-------|-------|---------------|----------------|---------------------|---|-------------------------|---|---|
| MODE | | | | | | | | |
| ● | ○ | ○ | ● | ○ | ○ | ○ | ○ | ● |

If the valve on the gas pipe side is not closed, refrigerant may flow into the piping after the compressor stops.

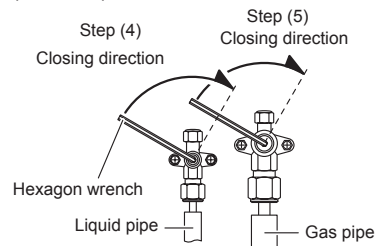

- (6) LED display changes after 1 minute as shown in the figure below.

| POWER | ERROR | TEST RUN (L1) | PUMP DOWN (L2) | LOW NOISE (L3) (L4) | | PEAK CUT (L5) (L6) (L7) | | |
|-------|-------|---------------|----------------|---------------------|---|-------------------------|---|---|
| MODE | | | | | | | | |
| ● | ○ | ○ | ● | ○ | ○ | ○ | ○ | ○ |

Fans and compressor stop automatically.

If the pump down is successfully completed (the above LED display is shown), the outdoor unit remains stopped until the power is turned off.

- (7) Turn the power off.

| POWER | ERROR | TEST RUN (L1) | PUMP DOWN (L2) | LOW NOISE (L3) (L4) | | PEAK CUT (L5) (L6) (L7) | | |
|-------|-------|---------------|----------------|---------------------|---|-------------------------|---|---|
| MODE | | | | | | | | |
| ○ | ○ | ○ | ○ | ○ | ○ | ○ | ○ | ○ |

PUMP DOWN is completed.

Notes:

- To stop pump down, press the **PUMP DOWN** switch again.
- To start the pump down again after the compressor is automatically stopped due to an error, turn the power off and open the 3-way valves. Wait 3 minutes, turn the power on and start the pump down again.
- When starting the operation after completion of the pump down, turn the power off, and then open the 3-way valves. Wait 3 minutes, turn the power on and perform a test run in the "COOL" operation mode.

12. ERROR CODE DISPLAY

When an error occurs, "short-press" the **ENTER** switch once. The number of blinks of the LED indicates the type of error.

12.1. How to check error code

12.1.1. Display when an error occurs

| POWER MODE | ERROR | TEST RUN (L1) | PUMP DOWN (L2) | LOW NOISE (L3) (L4) | | PEAK CUT (L5) (L6) (L7) | | |
|------------|-------------------|---------------|----------------|---------------------|---|-------------------------|---|---|
| ● | Blinks (Hi-speed) | ○ | ○ | ○ | ○ | ○ | ○ | ○ |

Check that the ERROR LED blinks, and then short-press the **ENTER** switch once.

12.2. Error code check table

| POWER MODE | ERROR | TEST RUN (L1) | PUMP DOWN (L2) | LOW NOISE (L3) (L4) | | PEAK CUT (L5) (L6) (L7) | | | Description |
|------------|-------|---------------|----------------|---------------------|---|-------------------------|---|---|---|
| ◆(2) | ● | ◆(1) | ◆(1) | ○ | ○ | ○ | ● | ● | Serial forward transmission error immediately after operation |
| ◆(2) | ● | ◆(1) | ◆(1) | ○ | ○ | ● | ○ | ○ | Serial forward transmission error during operation |
| ◆(2) | ● | ◆(2) | ◆(2) | ○ | ○ | ○ | ○ | ● | Indoor unit capacity error |
| ◆(2) | ● | ◆(5) | ◆(15) | ○ | ○ | ○ | ○ | ● | Indoor unit error |
| ◆(2) | ● | ◆(6) | ◆(1) | ○ | ○ | ○ | ○ | ● | Over voltage |
| ◆(2) | ● | ◆(6) | ◆(1) | ○ | ○ | ○ | ● | ● | Power supply frequency error |
| ◆(2) | ● | ◆(6) | ◆(2) | ○ | ○ | ○ | ○ | ● | Outdoor unit PCB model information error |
| ◆(2) | ● | ◆(6) | ◆(2) | ○ | ○ | ● | ● | ○ | Outdoor unit inverters communication error |
| ◆(2) | ● | ◆(6) | ◆(2) | ○ | ○ | ● | ● | ● | PFC communication error |
| ◆(2) | ● | ◆(6) | ◆(3) | ○ | ○ | ○ | ○ | ● | Inverter error |
| ◆(2) | ● | ◆(6) | ◆(4) | ○ | ○ | ● | ● | ● | PFC AD detection error |
| ◆(2) | ● | ◆(6) | ◆(4) | ○ | ● | ○ | ○ | ○ | PFC hardware error |
| ◆(2) | ● | ◆(6) | ◆(5) | ○ | ○ | ○ | ● | ● | IPM error (Trip terminal L error) |
| ◆(2) | ● | ◆(6) | ◆(8) | ○ | ○ | ○ | ● | ○ | Rush current limiting resistor temp rise protection |
| ◆(2) | ● | ◆(7) | ◆(1) | ○ | ○ | ○ | ○ | ● | Discharge temp. sensor error |
| ◆(2) | ● | ◆(7) | ◆(2) | ○ | ○ | ○ | ○ | ● | Compressor temp. sensor error |
| ◆(2) | ● | ◆(7) | ◆(3) | ○ | ○ | ○ | ● | ○ | Heat Ex. middle temp. sensor error |
| ◆(2) | ● | ◆(7) | ◆(3) | ○ | ○ | ○ | ● | ● | Outdoor unit Heat Ex. liquid temp. sensor error |
| ◆(2) | ● | ◆(7) | ◆(4) | ○ | ○ | ○ | ○ | ● | Outdoor temp. sensor error |
| ◆(2) | ● | ◆(7) | ◆(7) | ○ | ○ | ○ | ○ | ● | Heat sink temp. sensor error |
| ◆(2) | ● | ◆(7) | ◆(7) | ○ | ○ | ○ | ● | ○ | PFC heat sink temp. sensor error |
| ◆(2) | ● | ◆(8) | ◆(4) | ○ | ○ | ○ | ○ | ● | Current sensor 1 error (stoppage permanently) |
| ◆(2) | ● | ◆(8) | ◆(6) | ○ | ○ | ● | ○ | ○ | High pressure switch 1 error |
| ◆(2) | ● | ◆(8) | ◆(6) | ○ | ○ | ● | ● | ○ | Pressure sensor error |
| ◆(2) | ● | ◆(9) | ◆(4) | ○ | ○ | ○ | ○ | ● | Trip detection (stoppage permanently) |
| ◆(2) | ● | ◆(9) | ◆(5) | ○ | ○ | ○ | ○ | ● | Compressor motor control error (stoppage permanently) |
| ◆(2) | ● | ◆(9) | ◆(5) | ○ | ○ | ● | ○ | ● | Compressor motor loss of synchronization (stoppage permanently) |
| ◆(2) | ● | ◆(9) | ◆(7) | ○ | ○ | ○ | ● | ● | Outdoor unit fan motor 1 error (Duty error) |
| ◆(2) | ● | ◆(9) | ◆(8) | ○ | ○ | ○ | ● | ● | Outdoor unit fan motor 2 error (Duty error) |
| ◆(2) | ● | ◆(9) | ◆(9) | ○ | ○ | ○ | ○ | ● | 4-way valve error |
| ◆(2) | ● | ◆(10) | ◆(1) | ○ | ○ | ○ | ○ | ● | Discharge temp. 1 error (stoppage permanently) |
| ◆(2) | ● | ◆(10) | ◆(3) | ○ | ○ | ○ | ○ | ● | Compressor 1 temp. error (stoppage permanently) |
| ◆(2) | ● | ◆(10) | ◆(5) | ○ | ○ | ○ | ○ | ● | Low pressure error |

Display mode ● : Lights on
 ○ : Lights off
 ◆ : Blink (0.5s Lights on / 0.5s Lights off)
 () : Number of flashing