

ARXA024GLEH
ARXA030GLEH
ARXA036GLEH
ARXA045GLEH

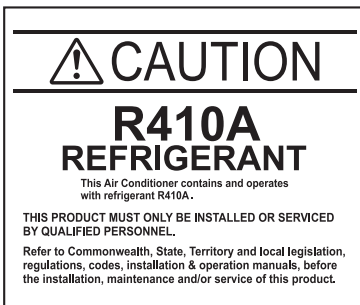

Refer to the rating label for the serial number, manufactured year and month.

FUJITSU GENERAL LIMITED

INSTALLATION MANUAL

INDOOR UNIT (Duct type)

For authorized service personnel only.

English

INSTALLATIONSANLEITUNG

INNENGERÄT (Kanaltyp)

Nur für autorisiertes Fachpersonal.

Deutsch

MANUEL D'INSTALLATION

UNITÉ INTÉRIEURE (type conduit)

Pour le personnel agréé uniquement.

Français

MANUAL DE INSTALACIÓN

UNIDAD INTERIOR (Tipo conducto)

Únicamente para personal de servicio autorizado.

Español

MANUALE DI INSTALLAZIONE

UNITÀ INTERNA (tipo a condotto)

A uso esclusivo del personale tecnico autorizzato.

Italiano

ΕΓΧΕΙΡΙΔΙΟ ΕΓΚΑΤΑΣΤΑΣΗΣ

ΕΣΩΤΕΡΙΚΗ ΜΟΝΑΔΑ (Τύπος αγωγού)

Μόνο για εξουσιοδοτημένο τεχνικό προσωπικό.

Ελληνικά

MANUAL DE INSTALAÇÃO

UNIDADE INTERIOR (Tipo de tubagem)

Apenas para técnicos autorizados.

Português

РУКОВОДСТВО ПО УСТАНОВКЕ

ВНУТРЕННИЙ МОДУЛЬ (Короб)

Только для авторизованного обслуживающего персонала.

Русский

MONTAJ KILAVUZU

İÇ ÜNİTE (Kanal tipi)

Yalnızca yetkili servis personeli için.

Türkçe

MADE IN P.R.C.



[Original instructions]

PART No. 9373385257

INSTALLATION MANUAL

PART No. 9373385257

VRF system indoor unit (Duct type)

Contents

1. SAFETY PRECAUTIONS.....	1
2. ABOUT THIS PRODUCT.....	1
2.1. Precautions for using the R410A refrigerant.....	1
2.2. Special tool for R410A.....	1
2.3. Accessories	2
2.4. Optional parts	2
3. INSTALLATION WORK	3
3.1. Selecting an installation location	3
3.2. Installation dimensions	3
3.3. Installing the unit.....	3
4. PIPE INSTALLATION	5
4.1. Selecting the pipe material	5
4.2. Pipe requirement	5
4.3. Flare connection (pipe connection)	5
4.4. Installing heat insulation	6
5. INSTALLING DRAIN PIPES	6
6. ELECTRICAL WIRING	8
6.1. Electrical requirement.....	8
6.2. Wiring method	9
6.3. Unit wiring	9
6.4. Connection of wiring	10
6.5. Optional parts wiring.....	10
6.6. External input and external output (Optional parts).....	11
6.7. Remote sensor (Optional parts)	12
6.8. IR receiver unit (Optional parts).....	12
6.9. Drain pump unit (Optional parts)	12
7. FIELD SETTING.....	13
7.1. Setting the address.....	13
7.2. Custom code setting.....	13
7.3. Static pressure mode.....	13
7.4. Function setting	14
8. TEST RUN.....	14
8.1. Test run using Outdoor unit (PCB).....	14
8.2. Test run using Remote Controller.....	14
9. CHECK LIST	14
10. ERROR CODES	15

1. SAFETY PRECAUTIONS

- Be sure to read this Manual thoroughly before installation.
- The warnings and precautions indicated in this Manual contain important information pertaining to your safety. Be sure to observe them.
- Hand this Manual, together with the Operating Manual to the customer. Request the customer to keep them on hand for future use, such as for relocating or repairing the unit.

 WARNING	This mark indicates procedures which, if improperly performed, might lead to the death or serious injury of the user.
Request your dealer or a professional installer to install the unit in accordance with this Manual. An improperly installed unit can cause serious accidents such as water leakage, electric shock, or fire. If the unit is installed in disregard of the instructions in the Installation Manual, it will void the manufacturer's warranty.	
Do not turn ON the power until all work has been completed. Turning ON the power before the work is completed can cause serious accidents such as electric shock or fire.	
If refrigerant leaks while work is being carried out, ventilate the area. If the refrigerant comes in contact with a flame, it produces a toxic gas.	
Installation work must be performed in accordance with national wiring standards by authorized personnel only.	
Except for EMERGENCY, never turn off main as well as sub breaker of the indoor units during operation. It will cause compressor failure as well as water leakage. First, stop the indoor unit by operating the control unit, converter or external input device and then cut the breaker. Make sure to operate through the control unit, converter or external input device. When the breaker is designed, locate it at a place where the users cannot start and stop in the daily work.	

 CAUTION	This mark indicates procedures which, if improperly performed, might possibly result in personal harm to the user, or damage to property.
Read carefully all security information before use or install the air conditioner.	
Do not attempt to install the air conditioner or a part of the air conditioner by yourself.	
This unit must be installed by qualified personnel with a capacity certificate for handling refrigerant fluids. Refer to regulation and laws in use on installation place.	
The installation must be carried out in compliance with regulations in force in the place of installation and the installation instructions of the manufacturer.	
This unit is part of a set constituting an air conditioner. It must not be installed alone or with non-authorized by the manufacturer.	
Always use a separate power supply line protected by a circuit breaker operating on all wires with a distance between contact of 3mm for this unit.	
The unit must be correctly grounded and the supply line must be equipped with a differential breaker in order to protect the persons.	
The units are not explosion proof and therefore should not be installed in explosive atmosphere.	
Never touch electrical components immediately after the power supply has been turned off. Electric shock may occur. After turning off the power, always wait 5 minutes before touching electrical components.	
This unit contains no user-serviceable parts. Always consult authorized service personnel to repairs.	
When moving, consult authorized service personnel for disconnection and installation of the unit.	

2. ABOUT THIS PRODUCT

2.1. Precautions for using the R410A refrigerant

 WARNING
Do not introduce any substance other than the prescribed refrigerant into the refrigeration cycle. If air enters the refrigeration cycle, the pressure in the refrigeration cycle will become abnormally high and cause the piping to rupture.
If there is a refrigerant leakage, make sure that it does not exceed the concentration limit. If a refrigerant leakage exceeds the concentration limit, it can lead to accidents such as oxygen starvation.
Do not touch refrigerant that has leaked from the refrigerant pipe connections or other area. Touching the refrigerant directly can cause frostbite.
If a refrigerant leakage occurs during operation, immediately vacate the premises and thoroughly ventilate the area. If the refrigerant comes in contact with a flame, it produces a toxic gas.

2.2. Special tool for R410A

 WARNING
To install a unit that uses the R410A refrigerant, use dedicated tools and piping materials that have been manufactured specifically for R410A use. Because the pressure of the R410A refrigerant is approximately 1.6 times higher than the R22, failure to use dedicated piping material or improper installation can cause rupture or injury. Furthermore, it can cause serious accidents such as water leakage, electric shock, or fire.

Tool name	Contents of change
Gauge manifold	Pressure is huge and cannot be measured with a conventional (R22) gauge. To prevent erroneous mixing of other refrigerants, the diameter of each port has been changed. It is recommended to use a gauge manifold with a high pressure display range -0.1 to 5.3 MPa and a low pressure display range -0.1 to 3.8 MPa.
Charging hose	To increase pressure resistance, the hose material and base size were changed.
Vacuum pump	A conventional (R22) vacuum pump can be used by installing a vacuum pump adapter. Be sure that the pump oil does not backflow into the system. Use one capable for vacuum suction of -100.7 kPa (5 Torr, -755 mmHg).
Gas leakage detector	Special gas leakage detector for HFC refrigerant R410A.

2.3. Accessories











⚠ WARNING

For installation purposes, be sure to use the parts supplied by the manufacturer or other prescribed parts.
The use of non-prescribed parts can cause serious accidents such as the unit to fall, water leakage, electric shock, or fire.

The following installation parts are furnished. Use them as required.

Keep the Installation Manual in a safe place and do not discard any other accessories until the installation work has been completed.

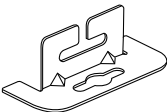
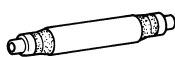
Do not discard any accessories needed for installation until the installation work has been completed.

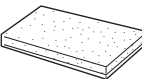
Name and Shape	Q'ty	Application
Operating manual 	1	
Installation manual 	1	(This book)
Cable tie (Large) 	5	For fixing the connection pipe (Large and Small) and drain cap
Cable tie (Medium) 	3	For transmission and remote controller cable binding
Coupler heat insulation (Small) 	1	For indoor side pipe joint (Small)
Coupler heat insulation (Large) 	1	For indoor side pipe joint (Large)
Special nut A (Large flange) 	4	For suspending the indoor unit from ceiling
Special nut B (Small flange) 	4	
Hanger 	4	For suspending the indoor unit from ceiling
Drain hose 	1	For installing drain pipe VP25 (O.D.32, I.D.25)
Hose band 	1	For installing drain hose
Drain hose insulation 	2	Insulates the drain hose and drain cap

2.4. Optional parts

When connecting the square duct and round duct, use the optional square flange or round flange.

Square flange

Model name : UTD-SF045T (P/N 9098180007)

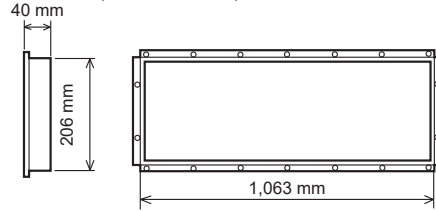

Round flange

Model name : UTD-RF204 (P/N 9093160004)

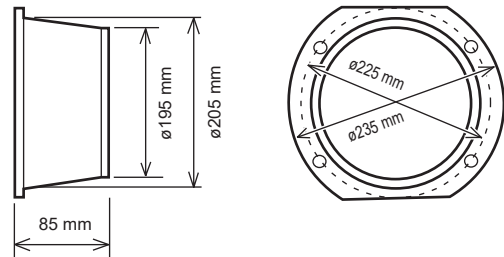

Long-life filter

Model name : UTD-LF25NA (P/N 9079892004)

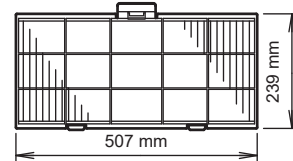

Other optional parts

Description	Model	Application
External connect kit	UTY-XWZXZC	For output function (Output terminal / CNB01)
	UTY-XWZXZB	For control input function (Apply voltage terminal / CNA01)
	UTY-XWZXZD	For control input function (Dry contact terminal / CNA02)
	UTY-XWZXZ7	For forced thermostat off function (Apply voltage terminal / CNA03)
	UTY-XWZXZE	For forced thermostat off function (Dry contact terminal / CNA04)
Remote sensor	UTY-XSZX	Room temperature sensor
IR receiver unit	UTY-TRHX	For the wireless remote controller.
Drain pump unit	UTZ-PX1NBA	
Wireless LAN adapter	UTY-TFSXZ*	For wireless LAN control.
External power supply unit	UTZ-GXXA	Supply power to the indoor unit PCB when the indoor unit is turned off to prevent errors.

When installing, please refer to the installation manual of each optional part.

3. INSTALLATION WORK

Correct initial installation location is important because it is difficult to move unit after it is installed.

3.1. Selecting an installation location

⚠ WARNING

Select installation locations that can properly support the weight of the indoor. Install the units securely so that they do not topple or fall.

⚠ CAUTION

Do not install the unit in the following areas:

- Area with high salt content, such as at the seaside.
It will deteriorate metal parts, causing the parts to fail or the unit to leak water.
- Area filled with mineral oil or containing a large amount of splashed oil or steam, such as a kitchen.
It will deteriorate plastic parts, causing the parts to fail or the unit to leak water.
- Area that generates substances that adversely affect the equipment, such as sulfuric gas, chlorine gas, acid, or alkali.
It will cause the copper pipes and brazed joints to corrode, which can cause refrigerant leakage.
- Area that can cause combustible gas to leak, contains suspended carbon fibers or flammable dust, or volatile inflammables such as paint thinner or gasoline.
If gas leaks and settles around the unit, it can cause a fire.
- Area where animals may urinate on the unit or ammonia may be generated.

Do not use the unit for special purposes, such as storing food, raising animals, growing plants, or preserving precision devices or art objects.
It can degrade the quality of the preserved or stored objects.

Do not install where there is the danger of combustible gas leakage.

Do not install the unit near a source of heat, steam, or flammable gas.

Install the unit where drainage does not cause any trouble.

Install the indoor unit, power supply cable, transmission cable, and remote controller cable at least 1 m away from a television or radio receivers. The purpose of this is to prevent TV reception interference or radio noise.
(Even if they are installed more than 1 m apart, you could still receive noise under some signal conditions.)

If children under 10 years old may approach the unit, take preventive measures so that they cannot reach the unit.

Decide the mounting position with the customer as follows:

- (1) Install the indoor unit on a place having a sufficient strength so that it withstands against the weight of the indoor unit.
- (2) The inlet and outlet ports should not be obstructed; the air should be able to blow all over the room.
- (3) Leave the space required to service the air conditioner.
- (4) A place from where the air can be distributed evenly throughout the room by the unit.
- (5) Install the unit where connection to the outdoor unit (or RB unit) is easy.
- (6) Install the unit where the connection pipe can be easily installed.
- (7) Install the unit where the drain pipe can be easily installed.
- (8) Install the unit where noise and vibrations are not amplified.
- (9) Take servicing, etc., into consideration and leave the spaces. Also install the unit where the filter can be removed.
- (10) Providing as much space as possible between the indoor unit and the ceiling will make work much easier.
- (11) If installing in a place where its humidity exceeds 80%, use heat insulation to prevent condensation.

3.2. Installation dimensions

- Provide the space around the unit as shown in the following figure.

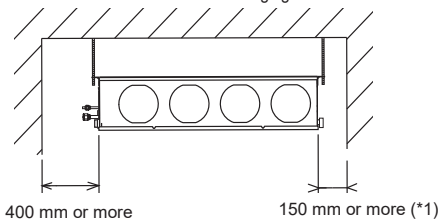

*1: 400 mm or more when drain from drain pipe.

- Provide a service access for inspection purposes.
- Do not place any wiring or illumination in the service space, as they will impede service.
- When an air filter is installed on the air inlet, provide enough service space to replace the filter.

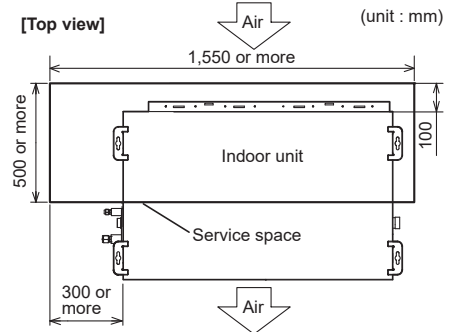
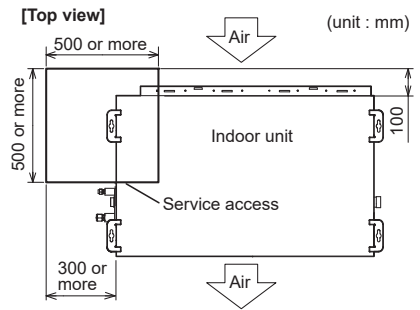

3.3. Installing the unit

⚠ WARNING

Install the air conditioner in a location which can withstand a load of at least 5 times the weight of the main unit and which will not amplify sound or vibration. If the installation location is not strong enough, the indoor unit may fall and cause injuries.

If the job is done with the panel frame only, there is a risk that the unit will come loose. Please take care.

3.3.1. Installing the hangers

Hanging bolt installation diagram.

(Top side)

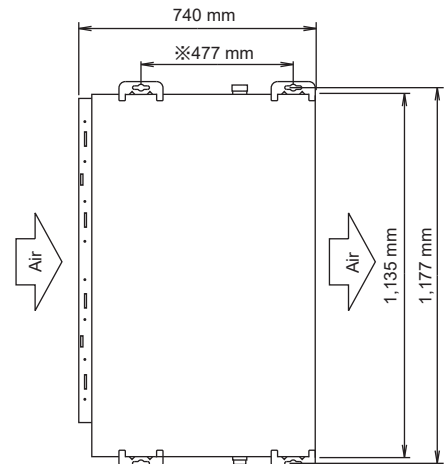

(Right side)

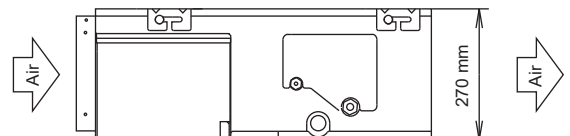

⚠ WARNING

When fastening the hangers, make the bolt positions uniform.

The distance of ※ is adjustable according to the place of the hanging bolts.

(MAX : 550 mm, MIN : 410 mm)

Slide the unit in the arrow direction and fasten it.

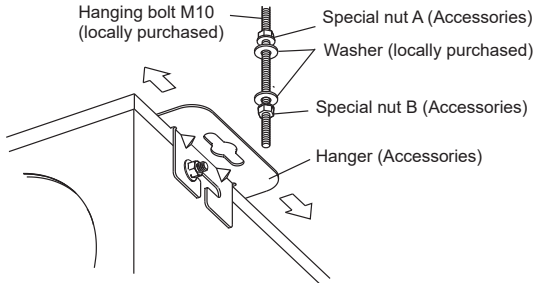

Bolt Strength	9.81 to 14.71 N.m
----------------------	-------------------

⚠ WARNING

Fasten the unit securely with special nuts A and B.

3.3.2. Leveling

Base vertical direction leveling on the unit (right and left).

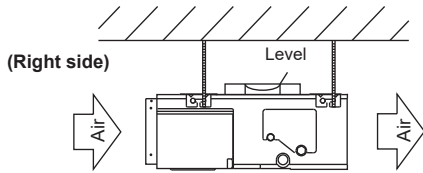

Base horizontal direction leveling on top of the unit.

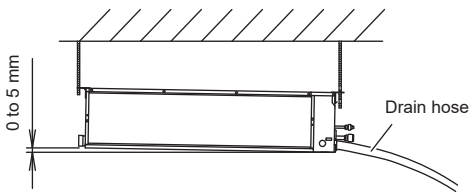

Give a slight tilt to the side to which the drain hose is connected. The tilt should be in the range of 0 mm to 5 mm.

3.3.3. Intake duct

Follow the procedure in the following figure to the ducts.

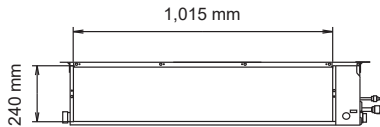

The air inlet duct can be changed by replacing the intake grille and flange. For the bottom air intake, follow the procedure of ① → ② for installation. (The factory setting is back air intake.)

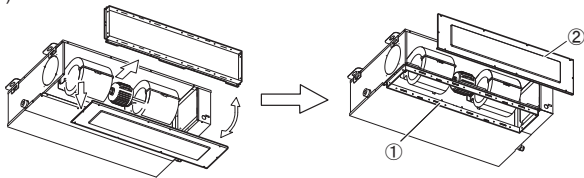

⚠ CAUTION

When air is taken in from the bottom side, the operating sound of the product will easily enter the room. Install the product and intake grilles where the affect of the operating sound is small.

Install the product and intake grilles where the affect of the operating sound is small.

3.3.4. Outlet duct

Duct installation pattern (■ CUT PART)

Round duct outlet × 4 (Factory setting.)



Square duct



• When using the square duct, follow the procedure below to process outlet duct.

(1) Cut the slit seam with a cutter.

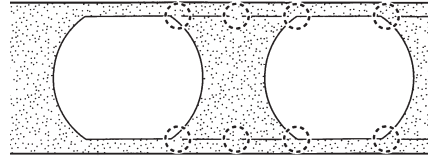

(2) Turn up the insulation around the points to be cut according to the outlet port shape working points so that the insulation does not stick out at the part.

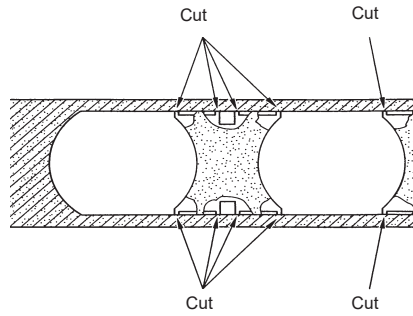

(3) Cut with nippers and remove the sheet metal.

• The screw holes to install the flange are located behind the round cutouts in the insulation.

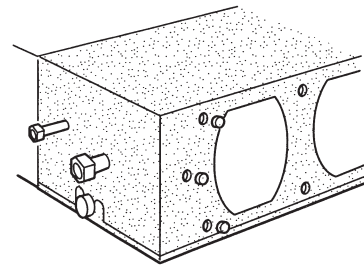

⚠ CAUTION

To prevent people from touching the parts inside the unit, be sure to install grilles on the inlet and outlet ports. The grilles must be designed in such a way that cannot be removed without tools.

If an intake duct is installed, take care not to damage the temperature sensor (the temperature sensor is attached to the intake port flange).

Install the air inlet grille for air circulation. The correct temperature can not be detected.

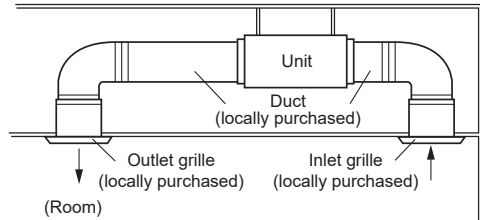

Be sure to install the air filter in the air inlet. If the air filter is not installed, the heat exchanger may be clogged and its performance may decrease.

3.3.5. Fresh air intake

(Processing before use)

- (1) When taking in fresh air, cut a slit shaped cabinet in the left side of the outer case with nippers.

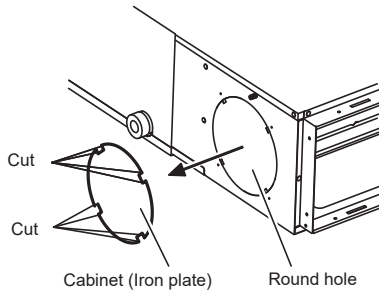

⚠ CAUTION

When removing the cabinet (iron plate), be careful not to damage the indoor unit internal parts and surrounding area (outer case).

When processing the cabinet (iron plate), be careful not to injure yourself with burrs, etc.

- (2) Install the round flange (optional parts) to the fresh air intake.

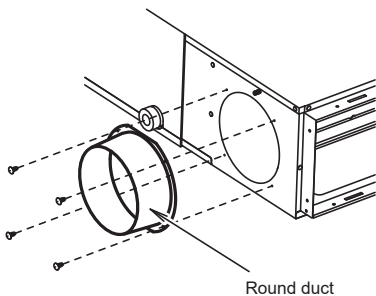

- (3) Connect the duct to the round flange.
- (4) Seal with a band and vinyl tape, etc. so that air does not leak from the connection.

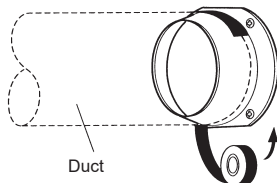

4. PIPE INSTALLATION

⚠ CAUTION

Be more careful that foreign matter (oil, water, etc.) does not enter the piping than with refrigerant R410A models. Also, when storing the piping, securely seal the openings by pinching, taping, etc.

While welding the pipes, be sure to blow dry nitrogen gas through them.

4.1. Selecting the pipe material

⚠ CAUTION

Do not use existing pipes from another refrigeration system or refrigerant.

Use pipes that have clean external and internal sides without any contamination which may cause trouble during use, such as sulfur, oxide, dust, cutting waste, oil, or water.

It is necessary to use seamless copper pipes.
Material : Phosphor deoxidized seamless copper pipes
It is desirable that the amount of residual oil is less than 40 mg/10 m.

Do not use copper pipes that have a collapsed, deformed, or discolored portion (especially on the interior surface). Otherwise, the expansion valve or capillary tube may become blocked with contaminants.

Improper pipe selection will degrade performance. As an air conditioner using R410A incurs pressure higher than when using conventional (R22) refrigerant, it is necessary to choose adequate materials.

- Thicknesses of copper pipes used with R410A are as shown in the table.
- Never use copper pipes thinner than those indicated in the table even if they are available on the market.

Thicknesses of Annealed Copper Pipes (R410A)

Pipe outside diameter [mm (in)]	Thickness [mm]
6.35 (1/4)	0.80
9.52 (3/8)	0.80
12.70 (1/2)	0.80
15.88 (5/8)	1.00
19.05 (3/4)	1.20

4.2. Pipe requirement

⚠ CAUTION

Refer to the Installation Manual of the outdoor unit for description of the length of connecting pipe or for difference of its elevation.

- Use pipe with water-resistant heat insulation.

⚠ CAUTION

Install heat insulation around both the gas and liquid pipes. Failure to do so may cause water leaks.

Use heat insulation with heat resistance above 120 °C. (Reverse cycle model only)
In addition, if the humidity level at the installation location of the refrigerant piping is expected to exceed 70 %, install heat insulation around the refrigerant piping. If the expected humidity level is 70 to 80 %, use heat insulation that is 15 mm or thicker and if the expected humidity exceeds 80 %, use heat insulation that is 20 mm or thicker. If heat insulation is used that is not as thick as specified, condensation may form on the surface of the insulation. In addition, use heat insulation with heat conductivity of 0.045 W/(m·K) or less (at 20 °C).

4.3. Flare connection (pipe connection)

⚠ WARNING

Tighten the flare nuts with a torque wrench using the specified tightening method. Otherwise, the flare nuts could break after a prolonged period, causing refrigerant to leak and generate hazardous gas if the refrigerant comes into contact with a flame.

4.3.1. Flaring

- Use special flare tool exclusive for R410A.

- (1) Cut the connection pipe to the necessary length with a pipe cutter.
- (2) Hold the pipe downward so that cuttings will not enter the pipe and remove any burrs.
- (3) Insert the flare nut (always use the flare nut attached to the indoor and outdoor units (or RB unit) respectively) onto the pipe and perform the flare processing with a flare tool. Use the special R410A flare tool. Leakage of refrigerant may result if other flare nuts are used.
- (4) Protect the pipes by pinching them or with tape to prevent dust, dirt, or water from entering the pipes.

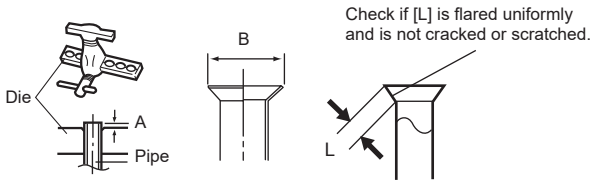

Pipe outside diameter [mm (in)]	Dimension A [mm]	Dimension B _{0.4} [mm]
	Flare tool for R410A, clutch type	
6.35 (1/4)	0 to 0.5	9.1
9.52 (3/8)		13.2
12.70 (1/2)		16.6
15.88 (5/8)		19.7
19.05 (3/4)		24.0

When using conventional (R22) flare tools to flare R410A pipes, the dimension A should be approximately 0.5 mm more than indicated in the table (for flaring with R410A flare tools) to achieve the specified flaring. Use a thickness gauge to measure the dimension A. It is recommended that a R410A flaring tool is used.

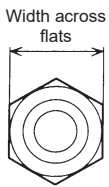

Pipe outside diameter [mm (in)]	Width across flats of Flare nut [mm]
6.35 (1/4)	17
9.52 (3/8)	22
12.70 (1/2)	26
15.88 (5/8)	29
19.05 (3/4)	36

4.3.2. Bending pipes

- If pipes are shaped by hand, be careful not to collapse them.
- Do not bend the pipes in an angle more than 90°.
- When pipes are repeatedly bend or stretched, the material will harden, making it difficult to bend or stretch them any more.
- Do not bend or stretch the pipes more than 3 times.

⚠ CAUTION

To prevent breaking of the pipe, avoid sharp bends.

If the pipe is bent repeatedly at the same place, it will break.

4.3.3. Pipe connection

When the flare nut is tightened properly by your hand, hold the body side coupling with a separate spanner, then tighten with a torque wrench. (See the table below for the flare nut tightening torques.)

⚠ CAUTION

Be sure to install the pipe against the port on the indoor unit correctly. If the centering is improper, the flare nut cannot tighten smoothly. If the flare nut is forced to turn, the threads will be damaged.

Do not remove the flare nut from the indoor unit pipe until immediately before connecting the connection pipe.

Hold the torque wrench at its grip, keeping at a the right angle with the pipe, in order to tighten the flare nut correctly.

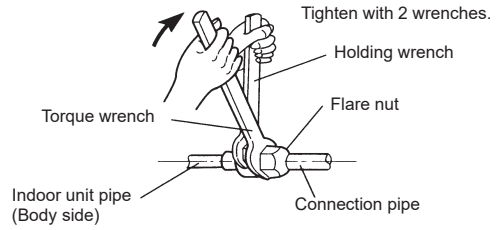

Flare nut [mm (in)]	Tightening torque [N·m (kgf·cm)]
6.35 (1/4) dia.	16 to 18 (160 to 180)
9.52 (3/8) dia.	32 to 42 (320 to 420)
12.70 (1/2) dia.	49 to 61 (490 to 610)
15.88 (5/8) dia.	63 to 75 (630 to 750)
19.05 (3/4) dia.	90 to 110 (900 to 1,100)

4.4. Installing heat insulation

- Insulate by the coupler heat insulation (Accessories) around the gas pipe and liquid pipe of indoor side.
- After installing the coupler heat insulation, wrap both end with vinyl tape so that there is no gap.
- After affixing the coupler heat insulation, secure it with 2 cable ties (large), one on each end of the insulation.
- Make sure that the cable ties overlap the heat insulation pipe.

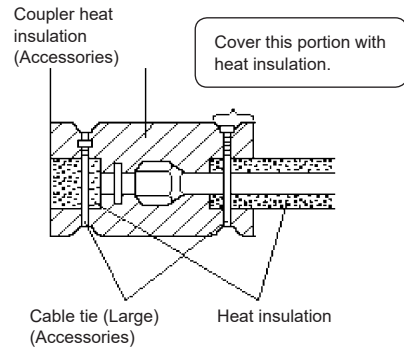

⚠ CAUTION

After checking for gas leaks (refer to the Installation Manual of the outdoor unit), perform this section.

Install heat insulation around both the large (gas) and small (liquid) pipes. Failure to do so may cause water leaks.

5. INSTALLING DRAIN PIPES

Use general hard polyvinyl chloride pipe and connect it with adhesive (polyvinyl chloride) so that there is no leakage.

Always heat insulate the indoor side of the drain hose.

Use a drain hose that matches the size of the drain pipe.

- Do not perform a rise, trap and air bleeding.
- Provide a downward gradient (1/100 or more).
- Provide supporters when long pipes are installed.
- Use an insulation material as needed, to prevent the pipes from freezing.
- Install the pipes in a way that allows for the removal of the control box.

(Right side)

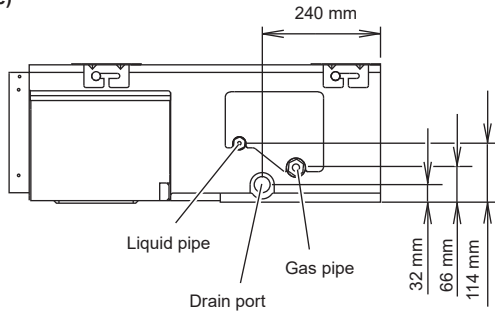

(Left side)

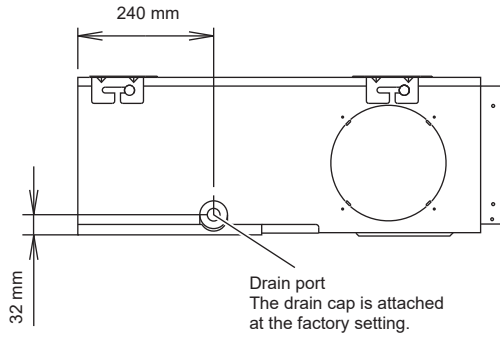

	O.D.
Drain pipe	32 mm (VP25)

- When the unit is shipped from the factory, the drain port is on the right side (control box side).
- When using the drain port on the left side of the unit, reinstall the drain cap to the right side drain port.

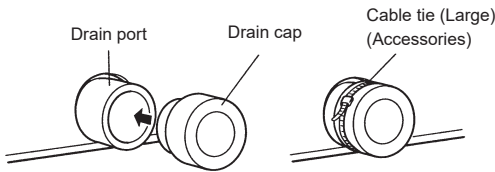

- Cover the drain cap with the drain hose insulation.

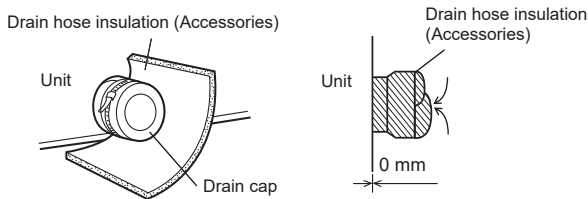

Install the drain hose

Working procedure

- 1) Install the attached drain hose to the drain port of the body. Install the hose band from the top of the hose within the graphic display area. Secure firmly with the hose band.
- 2) Use vinyl adhesive agent to glue the drain piping (PVC pipe VP25) which is prepared on site or socket. (Apply color adhesive agent evenly until the gauge line and seal)
- 3) Check the drainage.
- 4) Install the heat insulation.
- 5) Use the attached heat insulation to insulate the drain port and band parts of the body.

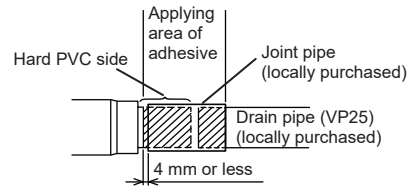
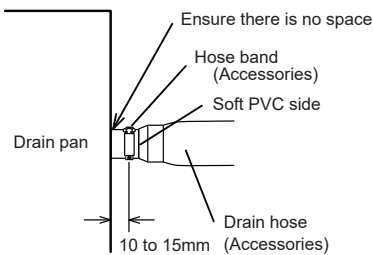

Wrap the Drain hose insulation around the drain hose connection.

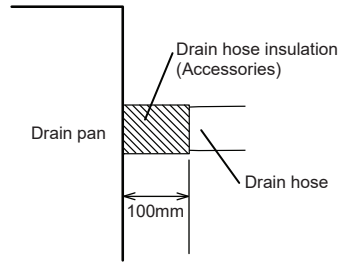

Hose opening view

Wind the attached heat insulation around the hose band. Make sure the alignment is on top.



After installing the Drain hose, check if the drainage is smooth.

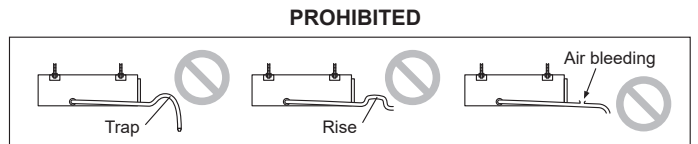
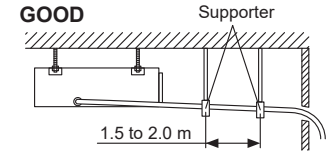
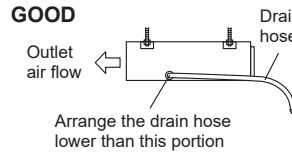
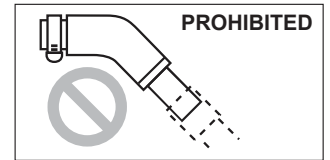
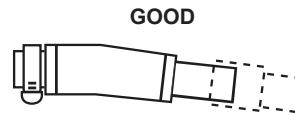
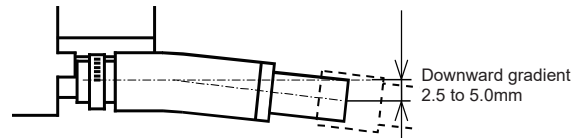

CAUTION

Always check that the drain cap is installed to the unused drain port and is fastened with the cable tie.
If the drain cap is not installed, or is not sufficiently fastened by the cable tie, water may drip during the cooling operation.

6. ELECTRICAL WIRING

WARNING

Electrical work must be performed in accordance with this Manual by a person certified under the national or regional regulations. Be sure to use a dedicated circuit for the unit.

An insufficient power supply circuit or improperly performed electrical work can cause serious accidents such as electric shock or fire.

Before starting work, check that power is not being supplied to the all units.

For wiring, use the prescribed type of wires, connect them securely, making sure that there are no external forces of the wires applied to the terminal connections. Improperly connected or secured wires can cause serious accidents such as overheating the terminals, electric shock, or fire.

Securely install the electrical box cover on the unit. An improperly installed electrical box cover can cause serious accidents such as electric shock or fire through exposure to dust or water.

Install sleeves into any holes made in the walls for wiring. Otherwise, a short circuit could result.

Use the included connection cables and power cables or ones specified by the manufacturer. Improper connections, insufficient insulation, or exceeding the allowable current can cause electric shock or fire.

Do not modify the power cables, use extension cables, or use any branches in the wiring. Improper connections, insufficient insulation, or exceeding the allowable current can cause electric shock or fire.

Match the terminal block numbers and connection cable colors with those of the outdoor unit (or RB unit). Erroneous wiring may cause burning of the electric parts.

Securely connect the connection cables to the terminal board. In addition, secure the cables with wiring holders. Improper connections, either in the wiring or at the ends of the wiring, can cause a malfunction, electric shock, or fire.

Always fasten the outside covering of the connection cable with the cable clamp. (If the insulator is chafed, electric leakage may occur.)

Install an earth leakage breaker. In addition, install the earth leakage breaker so that the entire AC main power supply is cut off at the same time. Otherwise, electric shock or fire could result.

Always connect the earth (ground) cable. Improper earthing (grounding) work can cause electric shocks.

Install the remote controller cables so as not to be direct touched with your hand.

Perform wiring work in accordance with standards so that the air conditioner can be operated safely and positively.

Connect the connection cables firmly to the terminal board. Imperfect installation may cause a fire.

If the supply cable is damaged, it must be replaced by the manufacturer, its service agent or similarly qualified persons in order to avoid a hazard.

CAUTION

Earth (Ground) the unit. Do not connect the earth (ground) cable to a gas pipe, water pipe, lightning rod, or a telephone earth (ground) cable. Improper earthing (grounding) may cause electric shock.

Do not connect power supply cables to the transmission or remote controller terminals, as this will damage the product.

Never bundle the power supply cable and transmission cable, remote controller cable together. Separate these cable by 50 mm or more. Bundling these cables together will cause miss operation or breakdown.

When handling PCB, static electricity charged in the body may cause malfunction of the PCB. Follow the cautions below:

- Establish an earth (ground) for the indoor and outdoor units and peripheral devices.
- Cut power (breaker) off.
- Touch metal part of the indoor unit for more than 10 seconds to discharge static electricity charged in the body.
- Do not touch terminals of parts and patterns implemented on PCB.

6.1. Electrical requirement

Voltage rating	230 V
Operating range	198 to 264 V (50 Hz) 198 to 253 V (60 Hz)

- Select the power cable type and size in accordance with relevant local and national regulations.
- Specifications for local wiring power cord and branch wiring are in compliance with local code.
- Max. wire length: Set a length so that the voltage drop is less than 2%. Increase the wire diameter when the wire length is long.

Breaker should be installed at every refrigerant system. Do not use a breaker in a different refrigerant system.

Refer to the table for the breaker specifications of each installation condition. Perform the power crossover wiring within the range of the same refrigerant system. When the crossover wiring is done, make a connection for indoor units to satisfy conditions A and B below.

A. Current breaker requirements

Model	MCA	MFA
ARXA024GLEH	1.00	20 A
ARXA030GLEH	1.12	
ARXA036GLEH	1.68	
ARXA045GLEH	2.12	

MCA: Minimum Circuit Ampacity

MFA: Main Fuse Ampacity

When the power crossover wiring is done, make it so that the total of the MCA of the connected RB units and indoor units does not exceed the 15 A. For RB unit MCA, refer to the RB unit installation manual.

If the capacity of connected RB units and indoor units exceeds the upper limit, either add breakers or use a breaker with a greater capacity.

B. Earth leakage breaker requirements

Breaker capacity	* Maximum connectable "indoor units" or "indoor units + RB units"
30 mA, 0.1 sec or less	44 or less
100 mA, 0.1 sec or less	45 to 148 **

* Heat pump type: indoor units, Heat recovery type: indoor units and RB units.

** If the 100 mA capacity breaker is not provided, split the quantity of the indoor units into small groups of 44 units or less and provide a breaker with capacity of 30 mA for each group.

6.1.1. Cable specifications

Follow the specifications below for the power supply, transmission and remote controller cable.

	Recommended cable size (mm ²)	Cable type	Remark
Power supply cable	2.5	Type 60245 IEC57 or equivalent	2 Cable + earth (ground)
Transmission cable	0.33	LONWORKS compatible cable	22 AWG LEVEL 4 (NEMA) non-polar 2 core, twisted pair solid core diameter 0.65 mm
Remote controller cable (2-wire type)	0.33 to 1.25	Sheathed PVC cable*	Non-polar 2 core, twisted pair

*: Use shielded cable in accordance with local rules for remote controller cable.

6.2. Wiring method

Example

Outdoor unit or RB unit *1

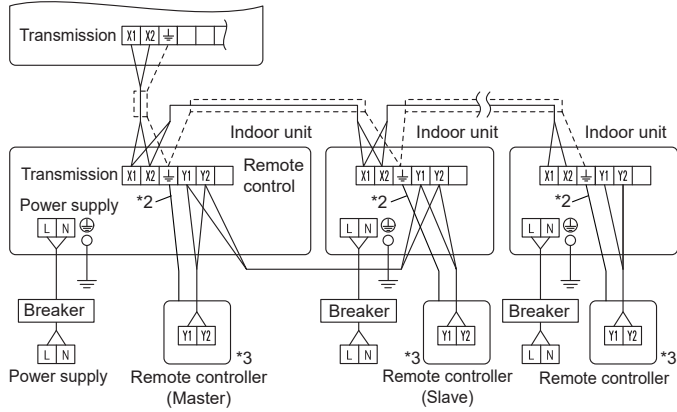

*1: When connecting to the Heat Recovery System, refer to the installation manual of the RB unit.

*2: Earth (Ground) the remote controller if it has an earth (ground) cable.

*3: The 3-wire type remote controller is not used.

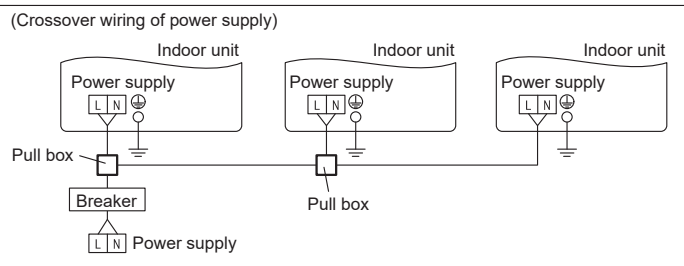

* Earth (Ground) the remote controller if it has an earth (ground) wire.

Connect the earth (ground) wire of the remote controller to the earth (ground) terminal of transmission.

6.3. Unit wiring

Before attaching the cable to terminal block.

6.3.1. Power supply cable

Adjust the length of power supply cable to avoid excessive tension with referring figure below.

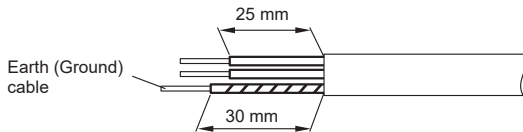

A. For solid core wiring

- To connect the electrical terminal, follow the below diagram and connect after looping it around the end of the cable.
- Use the specified cables, connect them securely, and fasten them so that there is no stress placed on the terminals.
- Use an appropriate screwdriver to tighten the terminal screws.
Do not use a screwdriver that is too small, otherwise, the screw heads may be damaged and prevent the screws from being properly tightened.
- Do not tighten the terminal screws too much, otherwise, the screws may break.
- See the table for the terminal screw tightening torques.
- Please do not fix 2 power supply cables with 1 screw.

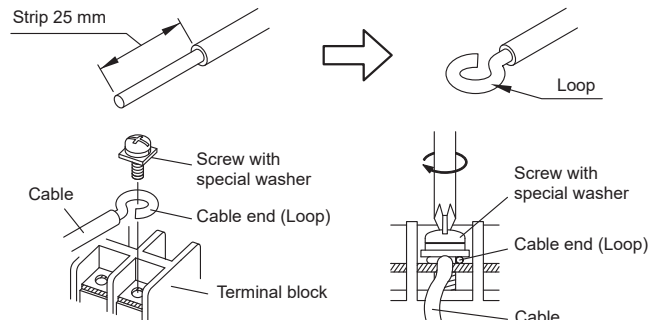

⚠ WARNING

When using solid core cables, do not use the ring terminal. If you use the solid core cables with the ring terminal, the ring terminal's pressure bonding may malfunction and cause the cables to abnormally heat up.

B. For strand wiring

- Use ring terminals with insulating sleeves as shown in the figure below to connect to the terminal block.
- Securely clamp the ring terminals to the cables using an appropriate tool so that the cables do not come loose.
- Use the specified cables, connect them securely, and fasten them so that there is no stress placed on the terminals.
- Use an appropriate screwdriver to tighten the terminal screws.
Do not use a screwdriver that is too small, otherwise, the screw heads may be damaged and prevent the screws from being properly tightened.
- Do not tighten the terminal screws too much, otherwise, the screws may break.
- See the table for the terminal screw tightening torques.
- Please do not fix 2 power supply cables with 1 screw.

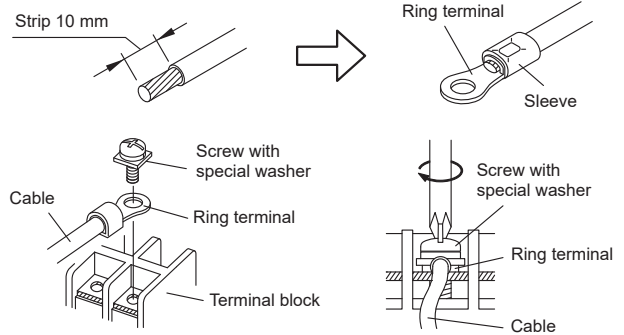

⚠ WARNING

Use ring terminals and tighten the terminal screws to the specified torques, otherwise, abnormal overheating may be produced and possibly cause heavy damage inside the unit.

Tightening torque

M4 screw (Power supply /L, N, GND)	1.2 to 1.8 N·m (12 to 18 kgf·cm)
---------------------------------------	-------------------------------------

6.3.2. Transmission and Remote controller cable

Transmission cable

Remote controller cable



- Connect remote controller and transmission cables as shown in Fig. A.

Fig. A

GOOD

PROHIBITED

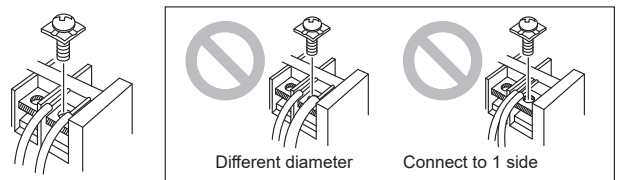

⚠ WARNING

Tighten the terminal screws to the specified torques, otherwise, abnormal overheating may be produced and possibly cause heavy damage inside the unit.

Tightening torque

M3 screw (Transmission /X1, X2) (Remote controller /Y1, Y2)	0.5 to 0.6 N·m (5 to 6 kgf·cm)
--	-----------------------------------

⚠ CAUTION

To peel the film from the lead cable, use a dedicated tool that will not damage the conductor cable.

When installing a screw on the terminal block, do not cut the cable by overtightening the screw. On the other hand, an undertightened screw can cause faulty contact, which will lead to a communication failure.

6.4. Connection of wiring

(1) Remove the control box cover and install each connection cable.

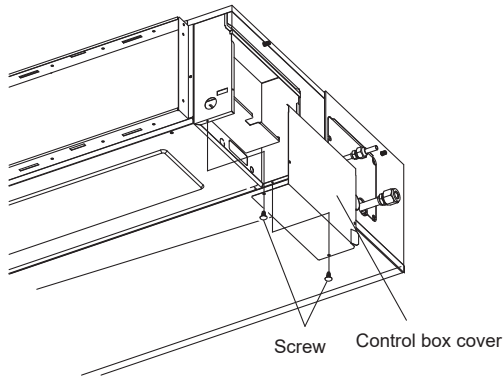

(2) After wiring is complete, secure the remote controller cable, connection cable, and power cable with the cable clamps.

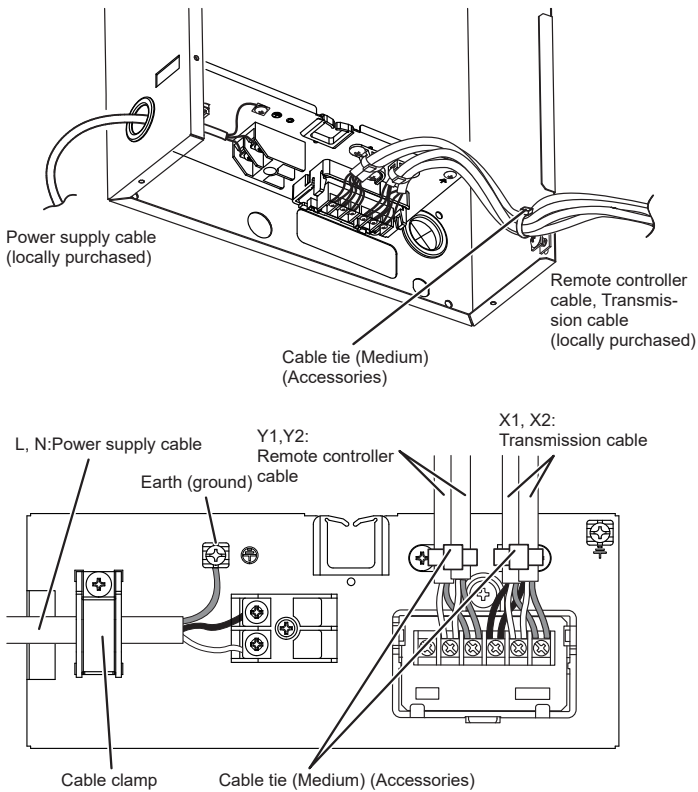

6.5. Optional parts wiring

6.5.1. Layout of the indoor unit PCB

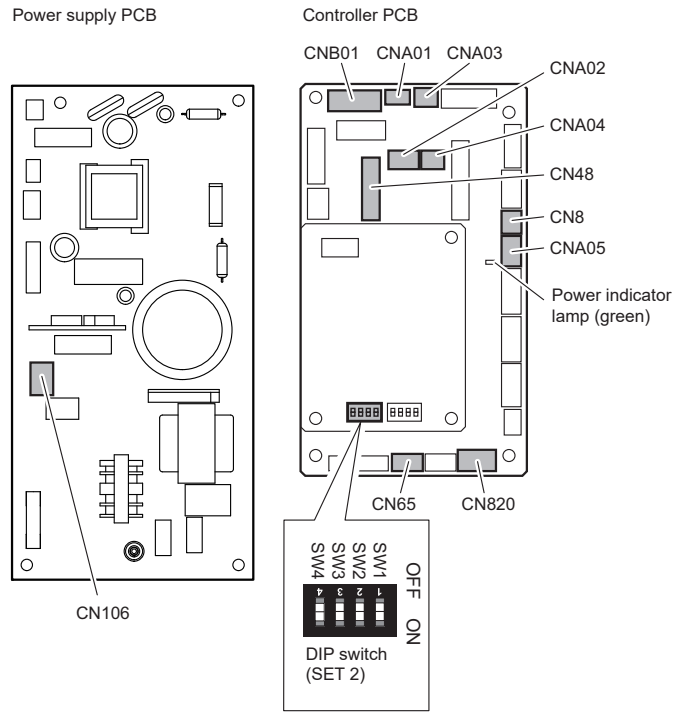

Name	Application
Power indicator lamp (green)	Indicates the state of the power supply. Refer to "Power indicator lamp status" following.
CNA01	Apply voltage terminal
CNA02	Dry contact terminal
CNA03	For external input
CNA04	
DIP switch SET 2 (SW2)	Input signal type switching
CNB01	Output terminal
CN8	For Remote sensor unit (*1)
CN48	For IR receiver unit (*1)
CN65	For one of the following. • MODBUS® converter (*1) • Wireless LAN adapter (*1)
CNA05	For Drain pump unit (*1)
CN106	
CN820	For External power supply unit (*1)

*1: For details, refer to each installation manual.

6.5.2. Power indicator lamp status

Power indicator lamp (Green)	Status contents
○ Lit	Lit when the power is turned on.
● Fast flashing (every 0.1 second)	There is a fault with the communication board or the main board.
● Blinking (repeat 3 seconds ON and 1 second OFF)	The indoor unit is turned off and power is supplied from the External power supply unit (optional) to the indoor unit PCB.

6.5.3. Connection methods

Wire modification for External input/output wire

- Remove insulation from wire attached to wire kit connector.
- Remove insulation from field supplied cable. Use crimp type insulated butt connector to join field cable and wire kit wire.
- Connect the wire with connecting wire with solder.

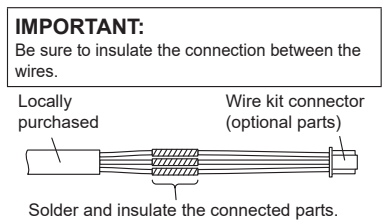

Wiring arrangement

In following figure, all the possible connectors are connected for description.
In actual installation, you cannot connect all the connectors at once.

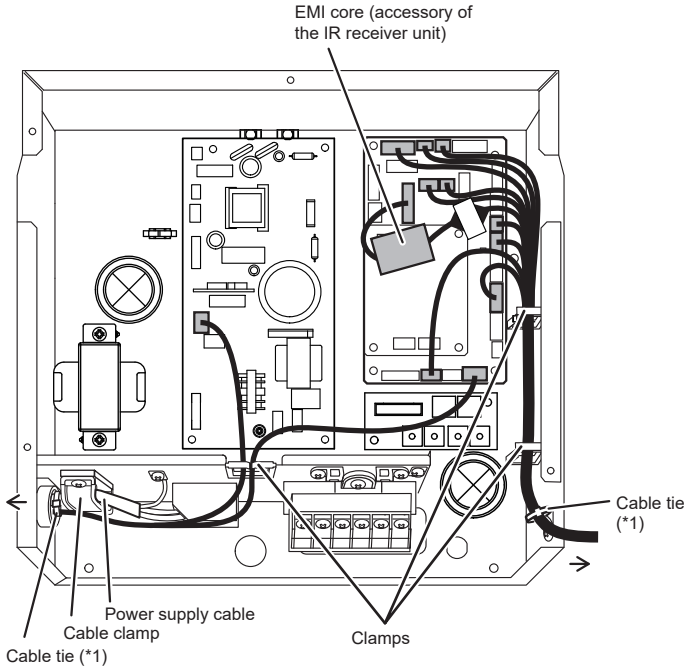

*1: Cable ties for Drain pump unit are accessories of the Drain pump unit.
Cable ties for other optional parts are locally purchased.

6.6. External input and external output (Optional parts)

(1) External input

- Indoor unit can be Operation/Stop, Emergency stop or Forced stop by using indoor unit PCB CNA01 or CNA02.
- "Operation/Stop" mode, "Emergency stop" mode or "Forced stop" mode can be selected with function setting of indoor unit.
- Indoor unit can be Forced thermostat off by using indoor unit PCB CNA03 or CNA04.
- A twisted pair cable (22 AWG) should be used. Maximum length of cable is 150 m.
- Use an external input and output cable with appropriate external dimension, depending on the number of cables to be installed.
- The wire connection should be separate from the power cable line.

Input select

Use either one of these types of terminal according to the application. (Both types of terminals cannot be used simultaneously.)

• Apply voltage terminal ([CNA01], [CNA03])

When a power supply must be provided at the input device you want to connect, use the Apply voltage terminal ([CNA01], [CNA03]).

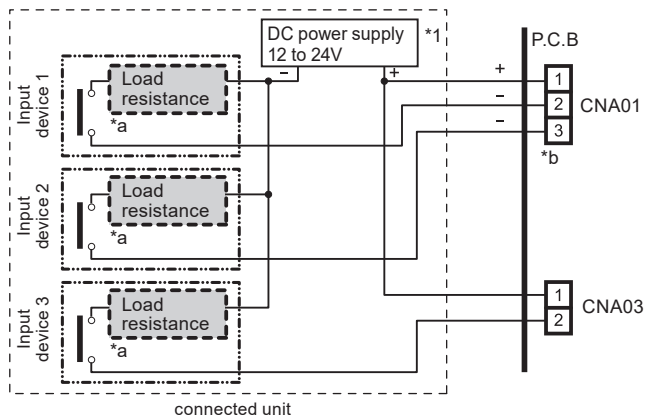

*1 Make the power supply DC12 to 24V. Select a power supply capacity with an ample surplus for the connected load.

Do not impress a voltage exceeding 24V across pins 1-2, and 1-3.

*a The allowable current is DC 5mA to 10mA. (Recommended: DC5mA)
Provide a load resistance such that the current becomes DC10mA or less.
Select very low current use contacts (usable at DC12V, DC1mA or less).

*b The polarity is [+] for pin 1 and [-] for pin 2 and 3. Connect correctly.

When connected to Apply voltage terminals of multiple indoor units with a connected unit, be sure to make a branch outside the indoor unit using a pull box, etc. as shown on below example.

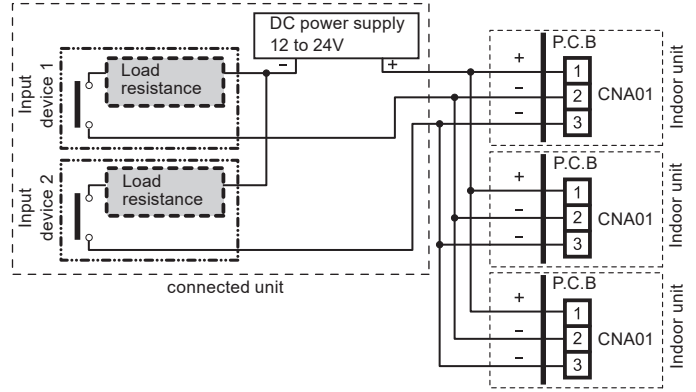

• Dry contact terminal ([CNA02], [CNA04])

When a power supply is unnecessary at the input device you want to connect, use the Dry contact terminal ([CNA02], [CNA04]).

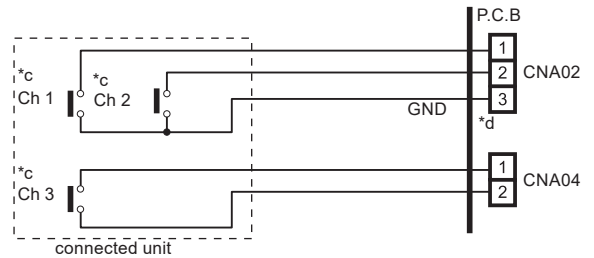

*c Select very low current use contacts (usable at DC12V, DC1mA or less).

*d The wiring is different from Apply voltage terminals. Be sufficiently careful when wiring.

When connected to Dry contact terminals of multiple indoor units with a connected unit, insulate each indoor unit with relay, etc. as shown on below example.

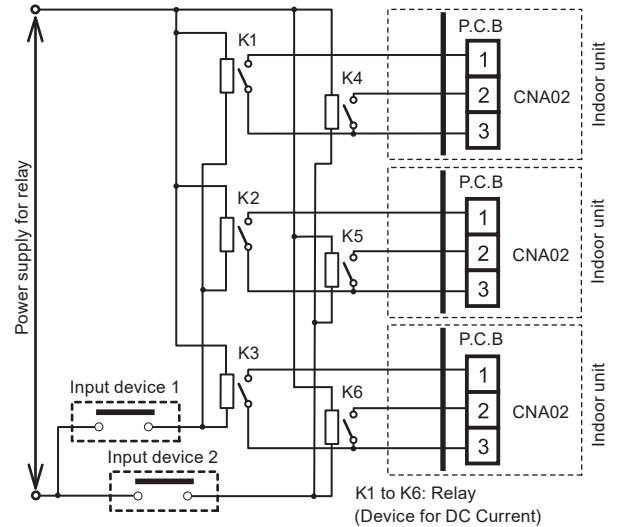

NOTE :

When connected to multiple indoor units directly, it will cause breakdown.

Operation behavior

• Input signal type

The input signal type can be selected.
It is switched by DIP switch on the indoor unit PCB.

DIP switch [Set 2 SW2]	Input signal type
OFF (Factory setting)	Edge
ON	Pulse

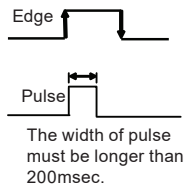

The width of pulse must be longer than 200msec.

- When function setting is "Operation/Stop" mode.
[In the case of "Edge" input]

Connector	Input signal	Command
Ch1 of CNA01 or CNA02	OFF → ON	Operation
	ON → OFF	Stop

[In the case of "Pulse" input]

Connector	Input signal	Command
CNA01 or CNA02	Ch1	OFF → ON Operation
	Ch2	OFF → ON Stop

- * The last command has priority.
- * The indoor units within the same remote controller group operates in the same mode.

- When function setting is "Emergency stop" mode.
[In the case of "Edge" input]

Connector	Input signal	Command
Ch1 of CNA01 or CNA02	OFF → ON	Emergency stop
	ON → OFF	Normal

[In the case of "Pulse" input]

Connector	Input signal	Command
CNA01 or CNA02	Ch1	OFF → ON Emergency stop
	Ch2	OFF → ON Normal

- * All indoor units of same refrigerant system stops when Emergency stop operates.

- When function setting is "Forced stop" mode.
[In the case of "Edge" input]

Connector	Input signal	Command
Ch1 of CNA01 or CNA02	OFF → ON	Forced stop
	ON → OFF	Normal

[In the case of "Pulse" input]

Connector	Input signal	Command
CNA01 or CNA02	Ch1	OFF → ON Forced stop
	Ch2	OFF → ON Normal

- * When the forced stop is triggered, indoor unit stops and Operation/Stop operation by a remote controller is restricted.
- * When forced stop function is used with forming a remote controller group, connect the same equipment to each indoor unit within the group.

- Selection method of functions
"Operation/Stop" mode or "Emergency stop" mode, "Forced stop" mode can be selected with function setting of indoor unit.

- Forced thermostat off function
["Edge" input only]

Function setting	Connector	Input signal	Command
60-00	Ch3 of CNA03 or CNA04	OFF → ON	Thermostat off
		ON → OFF	Normal

- Refrigerant leak detection function (only for J-III series)
["Edge" input only]

Function setting	Connector	Input signal	Command
60-09	Ch3 of CNA03 or CNA04	OFF → ON	No command
		ON → OFF	Refrigerant leak

(2) External output

- A twisted pair cable (22AWG) should be used. Maximum length of cable is 25m.
- Use an external input and output cable with appropriate external dimension, depending on the number of cables to be installed.
- Output voltage: Hi DC12V±2V, Lo 0V.
- Permissible current: 50mA

Output select

- When indicator etc. are connected directly

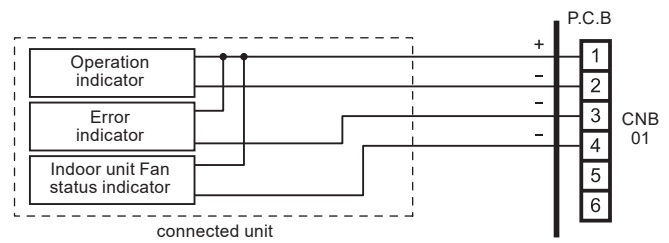

- When connecting with unit equipped with a power supply

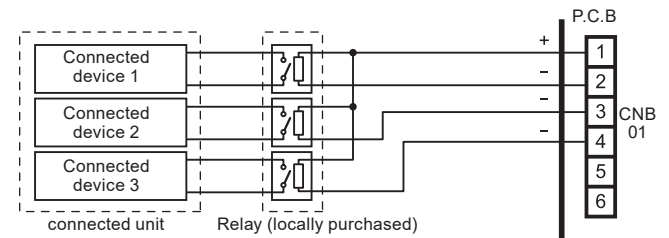

Operation behavior

Connector	Output voltage	Status	
CNB01	External output1 Pins 1-2	0V	Stop
		DC 12 V	Operation
	External output2 Pins 1-3	0V	Normal
		DC 12 V	Error
	External output3 Pins 1-4	0V	Indoor unit fan stop
		DC 12 V	Indoor unit fan operation

6.7. Remote sensor (Optional parts)

- For the installation method, please refer to the INSTALLATION MANUAL of remote sensor.

Connection methods

- Remove the existing connector and replace it with the remote sensor connector (ensure that the correct connector is used).
- The original connector should be insulated to ensure that it does not come into contact with other electrical circuitry.
- Use conduit hole when external output cable is used.

Setting for room temperature correction

When a remote sensor is connected, set the function setting of indoor unit as indicated below.

- Function Number "30":
Set the Setting Number to "00". (Default)
- Function Number "31":
Set the Setting Number to "02".
- * Refer to "7.4. Function setting" for details about Function Number and Setting Number.

6.8. IR receiver unit (Optional parts)

Connection method

- For the installation method, please refer to the INSTALLATION MANUAL of IR receiver unit.
- (1) Use 9 pins for receiver unit cable.
- (2) At first, connect the receiver unit cable to the controller PCB.
- (3) Attach the core that comes between controller PCB and the clamp.
- (4) Use conduit hole when external output cable is used.

6.9. Drain pump unit (Optional parts)

- For the installation method, please refer to the INSTALLATION MANUAL of drain pump unit.

7. FIELD SETTING

There are 3 methods for address setting by FIELD SETTING as follows.
Set by either of the methods.

Each setting method is described (1) to (3) below.

- (1) IU AD, REF AD SW settings..... This section (7.1. Setting the address)
- (2) Remote controller settings Refer to the wired or wireless remote controller manual for detailed setting information. (Set IU AD, REF AD SW to 0)
- (3) Automatic address settings Refer to the outdoor unit manual for detailed setting information. (Set IU AD, REF AD SW to 0)

CAUTION

- Be sure to turn OFF the power before performing the field setting.

7.1. Setting the address

Manual address setting method

- If the receiver unit is attached, the indoor unit address and the refrigerant circuit address can also be set up through the wireless remote controller.

CAUTION

Use an insulated screwdriver to set the DIP switches.

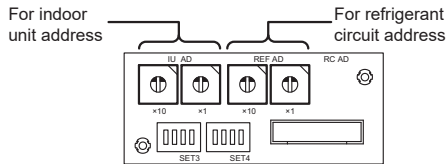

Setting	Setting range	Type of switch
Indoor unit address	0 to 63	<div style="display: flex; justify-content: space-around;"> <div style="text-align: center;"> <p>IU AD × 10</p> </div> <div style="text-align: center;"> <p>IU AD × 1</p> </div> </div>
Refrigerant circuit address	0 to 99	<div style="display: flex; justify-content: space-around;"> <div style="text-align: center;"> <p>REF AD × 10</p> </div> <div style="text-align: center;"> <p>REF AD × 1</p> </div> </div>

(1) Indoor unit address

Rotary switch (IU AD × 1)...Factory setting "0"

Rotary switch (IU AD × 10)...Factory setting "0"

When connecting multiple indoor units to 1 refrigerant system, set the address at IU AD SW as shown in the Table A.

(2) Refrigerant circuit address

Rotary switch (REF AD × 1)...Factory setting "0"

Rotary switch (REF AD × 10)...Factory setting "0"

In the case of multiple refrigerant systems, set REF AD SW as shown in the Table A for each refrigerant system.

Set to the same refrigerant circuit address as the outdoor unit.

- If working in an environment where the wireless remote controller can be used, the addresses can also be set using the remote controller.
- If setting the addresses using the wireless remote controller, set the indoor unit address and refrigerant circuit address to "00".
(For information on setting using the wireless remote controller.)

- * Do not set the indoor unit address (IU AD SW) at 64 to 99. It may result in failure.

Table A

Refrigerant circuit	Rotary switch setting		Indoor unit	Rotary switch setting	
	REF AD SW × 10	REF AD SW × 1		IU AD SW × 10	IU AD SW × 1
0	0	0	0	0	0
1	0	1	1	0	1
2	0	2	2	0	2
3	0	3	3	0	3
4	0	4	4	0	4
5	0	5	5	0	5
⋮	⋮	⋮	⋮	⋮	⋮
10	1	0	10	1	0
11	1	1	11	1	1
⋮	⋮	⋮	⋮	⋮	⋮
99	9	9	63	6	3

7.2. Custom code setting

Selecting the custom code prevents the indoor unit mix-up.
(Up to 4 codes can be set.)

Perform the setting for both the indoor unit and the remote controller.

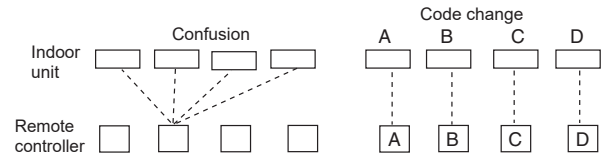

Custom code setting for indoor unit

Set the DIP switch SET 3 SW1, SW2 referring to the Table B.

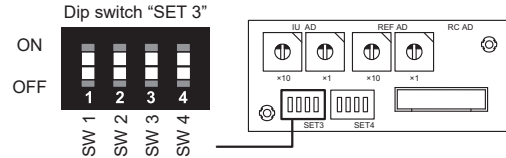

Table B

	Custom code			
	A (Factory setting)	B	C	D
DIP switch SET3 SW1	OFF	ON	OFF	ON
DIP switch SET3 SW2	OFF	OFF	ON	ON

7.3. Static pressure mode

CAUTION

If the applicable static pressure does not match the static pressure mode, the static pressure mode may be changed to another mode manually.

It is necessary to set up a static pressure mode for each usage of static pressure.
Static pressure can be set at site.

Relation between set values and static pressure are as the following table.

- FUNCTION SETTING can be performed with the wired or wireless remote controller.
(The remote controller is optional equipment)
- Refer to the wired or wireless remote controller manual for detailed setting information.

Function Number	Setting Number	Setting Static Pressure			
		AR024	AR030	AR036	AR045
26	00	SP mode 00			
	01	SP mode 01			
	02	SP mode 02			
	03	SP mode 03			
	04	SP mode 04			
	05	SP mode 05			
	06	SP mode 06			
	07	SP mode 07			
	08	SP mode 08			
	09	SP mode 09			
	10	SP mode 10			
	11	SP mode 11			
	12	SP mode 12			
	13	SP mode 13			
14	SP mode 14				
31	SP mode 31 (Factory setting)	40 Pa	50 Pa		60 Pa

- * Please refer to FAN PERFORMANCE CURVE within Design & Technical Data for the features of each setting.

7.4. Function setting

- FUNCTION SETTING can be performed with the wired or wireless remote controller. (The remote controller is optional equipment)
- Refer to the wired or wireless remote controller manual for detailed setting information.
- Refer to "7.1. Setting the address" for indoor unit address and refrigerant circuit address settings.
- Turn the power of the indoor unit ON before starting the setting.
- * Turning on the power to the indoor units initializes EEV, so make sure the piping air tight test and vacuuming have been conducted before turning on the power.
- * Also check again to make sure no wiring mistakes were made before turning on the power.

Function details

Function	Function number	Setting number	Default	Details
Filter indicator interval	11	00 Standard	○	Adjust the filter cleaning interval notification. If the notification is too early, change to setting 01. If the notification is too late, change to setting 02.
		01 Longer		
		02 Shorter		
Filter indicator action	13	00 Enable	○	Enable or disable the filter indicator. Setting 02 is for use with a central remote controller.
		01 Disable		
		02 Display only on central remote controller		
(Forbidden)	20	00	○	
(Forbidden)	23	00	○	
(Forbidden)	24	00	○	
Static pressure	26	Refer to "7.3. Static pressure mode"		
(Forbidden)	27		○	
Cool air temperature trigger	30	00 Standard	○	Adjust the cool air trigger temperature. To lower the trigger temperature, use setting 01. To raise the trigger temperature, use setting 02.
		01 Adjust (1)		
		02 Adjust (2)		
Heat air temperature trigger	31	00 Standard	○	Adjust the heat air trigger temperature. To lower the trigger temperature by 6 degrees C, use setting 01. To lower the trigger temperature by 4 degrees C, use setting 02. To raise the trigger temperature, use setting 03.
		01 Adjust (1)		
		02 Adjust (2)		
		03 Adjust (3)		
Auto restart	40	00 Enable		Enable or disable automatic system restart after a power outage.
		01 Disable	○	
Cool Air Prevention	43	00 Super low	○	Restrain the cold airflow with making the airflow lower when starting heating operation. To correspond to the ventilation, set to 01.
		01 Follow the setting on the remote controller		
External control	46	00 Start/Stop	○	Allow an external controller to start or stop the system, or to perform an emergency stop. * If an emergency stop is performed from an external controller, all refrigerant systems will be disabled. * If forced stop is set, indoor unit stops by the input to the external input terminals, and Start/Stop by a remote controller is restricted.
		01 Emergency stop		
		02 Forced stop		
Error report target	47	00 All	○	Change the target for reporting errors. Errors can either be reported in all locations, or only on the central remote controller.
		01 Display only on central remote controller		
Fan setting when cooling thermostat OFF	49	00 Follow the setting on the remote controller	○	When set to 01, the fan stops when the thermostat is OFF in cooling operation. Connection of the wired remote controller (2-wire type or 3-wire type) and switching its thermostat are necessary.
		01 Stop		
Switching function for external inputs	60	00 Forced thermostat off	○	Setting is required when connecting a refrigerant-leak detecting device. (only for J-III L series)
		01		
		02		
		03		
		04 (Forbidden)		
		05		
		06		
		07		
		08		
09 Refrigerant leak detection				
(Forbidden)	61	00	○	
(Forbidden)	62	00	○	
Auto mode type	68	00 Single setpoint auto mode (traditional)	○	Switch the setting method of auto mode to single or dual (cooling/heating). For heat pump systems, it is necessary to set the master indoor unit (by wired remote controller).
		01 Dual setpoint auto mode		

Function	Function number	Setting number	Default	Details
Deadband value	69	00 0°C	○	Choose the minimum temperature between cooling and heating settings (deadband) for Dual setpoint auto mode (set in No. 68).
		01 0.5°C		
		02 1.0°C		
		03 1.5°C		
		04 2.0°C		
		05 2.5°C		
		06 3.0°C		
		07 3.5°C		
		08 4.0°C		
		09 4.5°C		
(Forbidden)	70	00	○	
(Forbidden)	72	00	○	
(Forbidden)	73	00	○	
(Forbidden)	74	00	○	
(Forbidden)	75	00	○	

8. TEST RUN

8.1. Test run using Outdoor unit (PCB)

- Refer to the Installation Manual for the outdoor unit if the PCB for the outdoor unit is to be used for the test run.

8.2. Test run using Remote Controller

- Refer to the Installation Manual for the remote controller to perform the test run using the wireless remote controller.
- When the air conditioner is being test run, the OPERATION and TIMER indicator lamps flash slowly at the same time.

For details, please refer to the Manual of "IR Receiver Unit" or "Wired Remote Controller".

9. CHECK LIST

Pay special attention to the check items below when installing the indoor unit(s). After installation is complete, be sure to check the following check items again.

CHECK ITEMS	If not performed correctly	CHECK BOX
Has the indoor unit been installed correctly?	Vibration, noise, indoor unit may drop	
Has there been a check for gas leaks (refrigerant pipes)?	No cooling, No heating	
Has heat insulation work been completed?	Water leakage	
Does water drain easily from the indoor units?	Water leakage	
Is the voltage of the power source the same as that indicated on the label on the indoor unit?	No operation, heat or burn damage	
Are the wires and pipes all connected completely?	No operation, heat or burn damage	
Is the indoor unit earthed (grounded)?	Short circuit	
Is the connection cable the specified thickness?	No operation, heat or burn damage	
Are the inlets and outlets free of any obstacles?	No cooling, No heating	
Does start and stop air conditioner operation by remote controller or external device?	No operation	
After installation is completed, has the proper operation and handling been explained to the user?		

10. ERROR CODES

If you use a wired type remote controller, error codes will appear on the remote controller display. If you use a wireless remote controller, the lamp on the photodetector unit will output error codes by way of blinking patterns. See the lamp blinking patterns and error codes in the table below.

Error indications			Wired remote controller error code	Error contents
OPERATION lamp (green)	TIMER lamp (orange)	FILTER lamp (red)		
● (1)	● (2)	◇	12	Remote controller communication error
● (1)	● (4)	◇	14	Network communication error
● (1)	● (6)	◇	16	Peripheral unit communication error
● (2)	● (6)	◇	26	Indoor unit address setting error
● (2)	● (9)	◇	29	Connection unit number error in wired remote controller system
● (3)	● (1)	◇	31	Indoor unit power supply abnormal
● (3)	● (2)	◇	32	Indoor unit main PCB error
● (3)	● (10)	◇	3A	Indoor unit communication circuit (wired remote controller) error
● (4)	● (1)	◇	41	Indoor unit room temp. thermistor error
● (4)	● (2)	◇	42	Indoor unit heat ex. temp. thermistor error
● (5)	● (1)	◇	51	Indoor unit fan motor 1 error
● (5)	● (2)	◇	52	Indoor unit coil (expansion valve) error
● (5)	● (3)	◇	53	Indoor unit water drain abnormal
● (9)	● (15)	◇	9U	Outdoor unit miscellaneous error
● (10)	● (8)	◇	AB	Poor refrigerant circulation
● (13)	● (1)	◇	J1	RB unit error

Display mode ● : 0.5s ON / 0.5s OFF
 ◇ : 0.1s ON / 0.1s OFF
 () : Number of flashing

Wired remote controller display

UTY-RNR*Z* (2-wire type)

Touch the [Status]. Touch the [Error Information].

2-digit numbers are corresponding to the error code in the preceding table. Error Code [14,16]

For more information, refer to the installation manual of the remote controller.

UTY-RLR* (2-wire type)

Error icon Error code

For more information, refer to the installation manual of the remote controller.

For details on marking the ERROR CODES, please refer to the Manual of "IR Receiver Unit" or "Wired Remote Controller".