











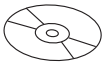
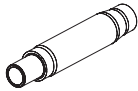

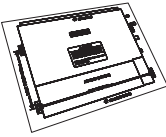
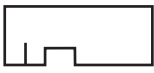



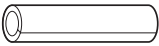

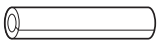

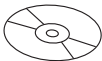
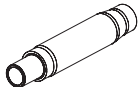
## 10. Accessories

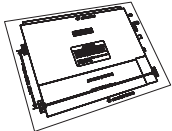
### 10-1. Models: ARXG09KLLAP, ARXG12KLLAP, and ARXG14KLLAP

Part name	Exterior	Q'ty	Part name	Exterior	Q'ty
Operating manual		1	Filter (small)		2
Operating manual (CD-ROM)		1	Drain hose		1
Installation manual		1	Hose band		1
Installation template		1	Drain hose insulation B		1
Washer		8	Insulation (for electrical wiring)		2
Cable tie (large)		4	Coupler heat insulation (large)		1
Cable tie (medium)		3	Coupler heat insulation (small)		1

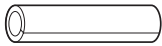
## 10-2. Model: ARXG18KLLAP

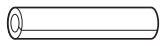
Part name	Exterior	Q'ty	Part name	Exterior	Q'ty
Operating manual		1	Filter (large)		2
Operating manual (CD-ROM)		1	Drain hose		1
Installation manual		1	Hose band		1
Installation template		1	Drain hose insulation B		1
Washer		8	Insulation (for electrical wiring)		2
Cable tie (large)		4	Coupler heat insulation (large)		1
Cable tie (medium)		3	Coupler heat insulation (small)		1

# 11. Optional parts



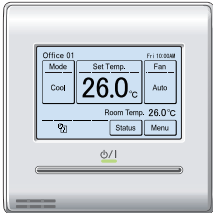
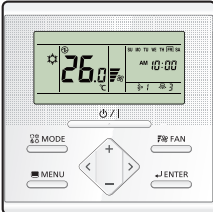
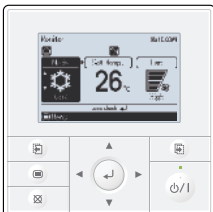
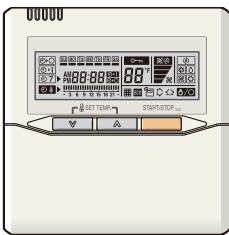
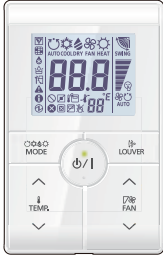
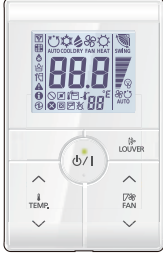
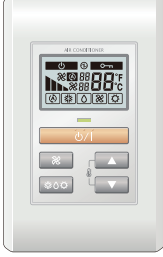



## 11-1. Controllers



Exterior	Part name	Model name	Summary
	Wired remote controller	UTY-RNRYZ*	Easy finger touch operation with LCD panel. Backlit LCD enables easy operation in a dark room. Wire type: Non-polar 2-wire
	Wired remote controller	UTY-RLRY	High visibility and easy operation. Room temperature can be accurately controlled using the built-in thermo sensor. Wire type: Non-polar 2-wire
	Wired remote controller	UTY-RVNYM	Large and full-dot liquid crystal screen, wide and large keys easy to press, user-intuitive arrow key. Wire type: Polar 3-wire
	Wired remote controller	UTY-RNNYM	Room temperature can be controlled by detecting the temperature accurately with built-in thermo sensor. Wire type: Polar 3-wire
	Simple remote controller	UTY-RSRY	Compact remote controller concentrates on the basic functions such as Start/Stop, fan control, temperature setting, and operation mode. Wire type: Non-polar 2-wire
	Simple remote controller	UTY-RHRY	Compact remote controller concentrates on the basic functions such as Start/Stop, fan control, and temperature setting. Wire type: Non-polar 2-wire
	Simple remote controller	UTY-RSNYM	Compact remote controller concentrates on the basic functions such as Start/Stop, fan control, temperature setting, and operation mode. Wire type: Polar 3-wire

Exterior	Part name	Model name	Summary
	IR receiver kit with wireless remote controller	UTY-LBTYM	Unit control is performed by wireless remote controller.

**NOTE:** Available functions may differ by the remote controller. For details, refer to the operation manual.

## 11-2. Others

Exterior	Part name	Model name	Summary
	Remote sensor unit	UTY-XSZX	Thermo-sensor for sensing the temperature of arbitrary place in the room.
	Auto louver grille kit	UTD-GXTA-W	Width: 683 mm For 09, 12, and 14 models
	Auto louver grille kit	UTD-GXTB-W	Width: 883 mm For 18 model
	External connect kit	UTY-XWZXZG	Use to connect with various peripheral devices and air conditioner PCB. For control output port.
	Wireless LAN adapter	UTY-TFSXZ1	Remotely manage an air conditioning system using mobile devices such as smartphones and tablets. For connection indoor unit with UART interface.
	Modbus converter	UTY-VMSX	For connection between indoor unit with UART interface and a Modbus open network.

Exterior	Part name	Model name	Summary
	KNX converter	UTY-VKSX	For connection between indoor unit with UART interface and a KNX open network.
	External switch controller	UTY-TERX	Air conditioner switching can be controlled by connecting other external sensor switches.

**NOTE:** Combined use of following optional parts and Wireless LAN adapter (UTY-TFSXZ1) is not allowed.

- Modbus converter
- KNX converter