

8. External input and output

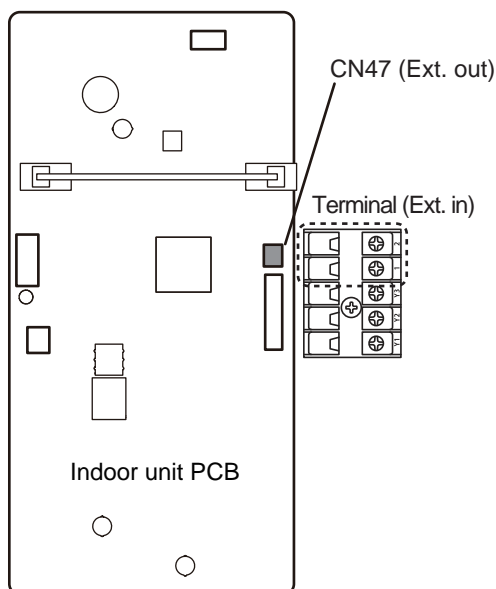

External input and output		Connector	Input select	Input signal	External connect kit (Optional parts)
External input	Operation/Stop Forced stop	Terminal	Dry contact	Edge	—
External output	Operation status	CN47	—	—	UTY-XWZXZG
	Error status				
	Indoor unit fan operation status				
	External heater output				

8-1. External input

- “Operation/Stop” mode or “Forced stop” mode can be selected with function setting of indoor unit.
- A twisted pair cable (22AWG) should be used. Maximum length of cable is 150 m.
- The wire connection should be separate from the power cable line.

Indoor unit functions such as Operation/Stop can be done by using indoor unit terminals.

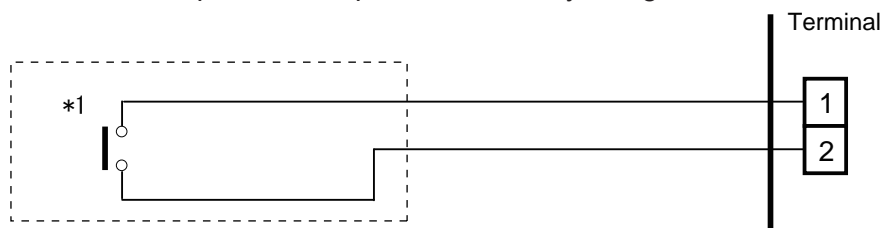

*1: The switch can be used on the following condition: DC 12 V to 24 V, 1 mA to 15 mA.

8-2. External output

Use an external output cable with appropriate external dimension, depending on the number of cables to be installed.

- A twisted pair cable (22AWG) should be used. Maximum length of cable is 25 m.
- Output voltage: High DC 12 V \pm 2 V, Low 0 V.
- Permissible current: 50 mA
- For details, refer to "[Combination of external input and output](#)" on page 37.

● When indicator, etc. are connected directly

Example: Function setting 60 is set to "00"

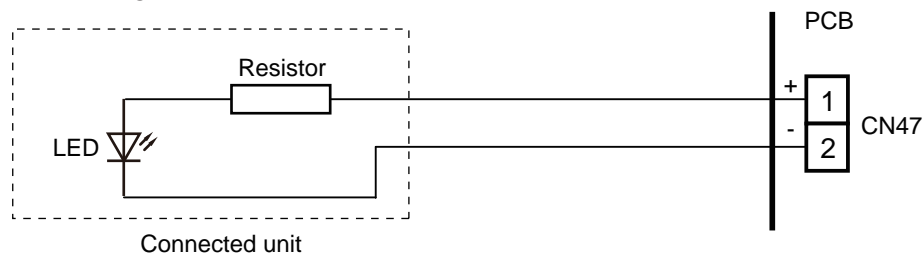

● When connecting with a device equipped with a power supply

Example: Function setting 60 is set to "00"

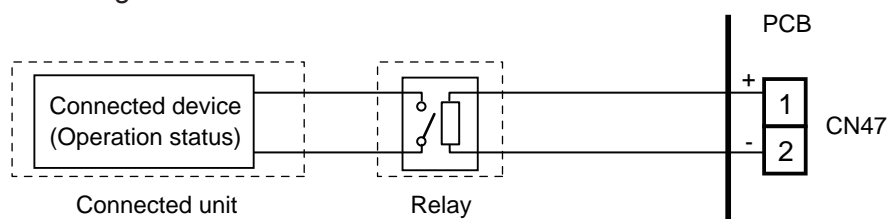

8-3. Combination of external input and output

By combining the function setting of the indoor unit, you can select various combinations of functions.

Combination examples of external input and output are as follows:

Mode	Function setting	External input	External output
		Terminal	CN47
0	60—00	Operation/Stop	
1—8	60—01 to 60—08	(Setting prohibited)	
9	60—09	Operation/Stop	Error status
10	60—10	Operation/Stop	Indoor unit fan operation status
11	60—11	Operation/Stop	External heater output

NOTE: Input of Operation/Stop depends on the setting of function setting 46.

- 00: Operation/Stop mode 1 (R.C. enabled)
- 01: (Setting prohibited)
- 02: Forced stop
- 03: Operation/Stop mode 2 (R.C. disabled)

■ Input signal type

- Indoor unit
Input signal type is only "Edge".



8-4. Details of function

■ Control input function

- When function setting is "Operation/Stop" mode 1

Function setting	External input	Input signal	Command
46—00	Terminal	Off → On	Operation
		On → Off	Stop

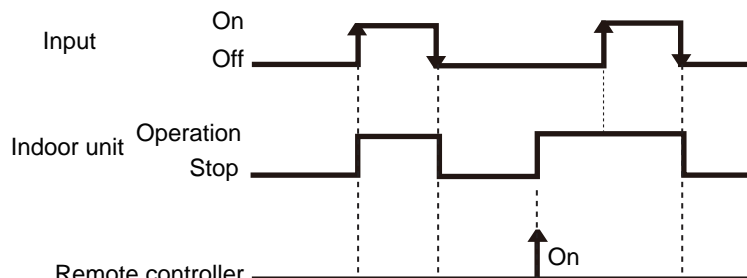

NOTES:

- The last command has priority.
- The indoor units within the same remote controller group operates in the same mode.

- When function setting is "Forced stop" mode

Function setting	External input	Input signal	Command
46—02	Terminal	Off → On	Forced stop
		On → Off	Normal

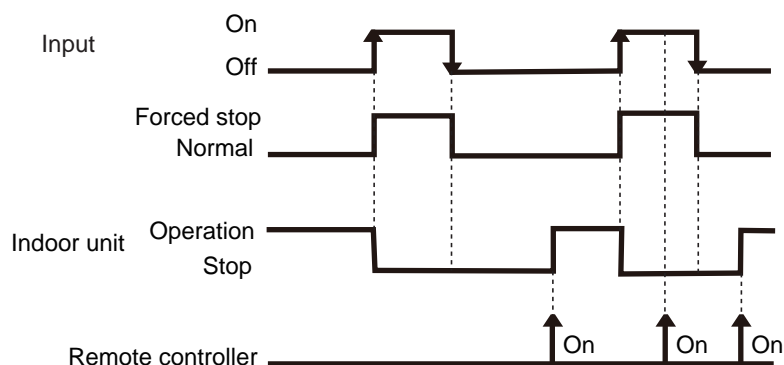

NOTES:

- When the forced stop is triggered, indoor unit stops and Operation/Stop operation by the remote controller is restricted.
- When forced stop function is used with forming a remote controller group, connect the same equipment to each indoor unit within the group.

- When function setting is "Operation/Stop" mode 2

Function setting	External input	Input signal	Command
46—03	Terminal	Off → On	Operation
		On → Off	Stop (R.C. disabled)

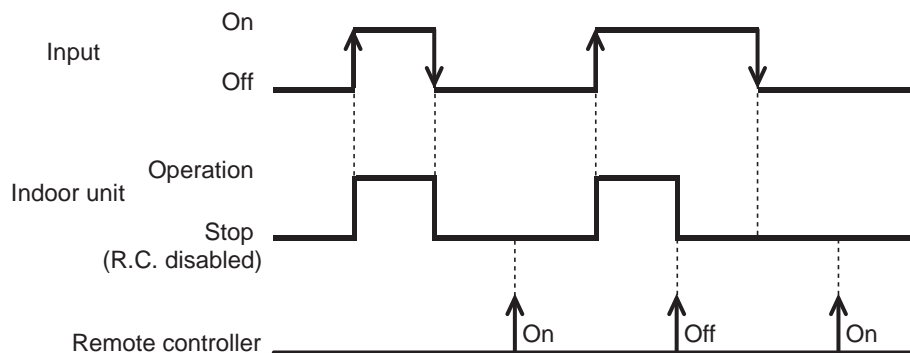

NOTE: When "Operation/Stop" mode 2 function is used with forming a remote controller group, connect the same equipment to each indoor unit within the group.

Control output function

Function setting	External output	Output signal	Command
60—00	CN47	Low → High	Operation
		High → Low	Stop

The output is low when the unit is stopped.

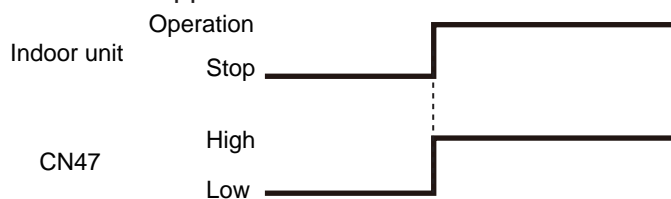

Error status

Function setting	External output	Output signal	Command
60—09	CN47	Low → High	Error
		High → Low	Normal

The output is ON when an error is generated for the indoor unit.

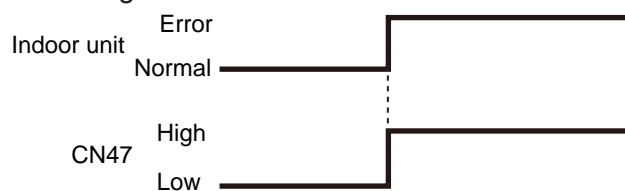

Indoor unit fan operation status

Function setting	External output	Output signal	Command
60—10	CN47	Low → High	Fan run
		High → Low	Fan stop

Output signal	Condition
On	The indoor unit fan is operating.
Low → High	
Off	The fan is stopped or during cold air prevention. During thermostat off when in dry mode operation.
High → Low	

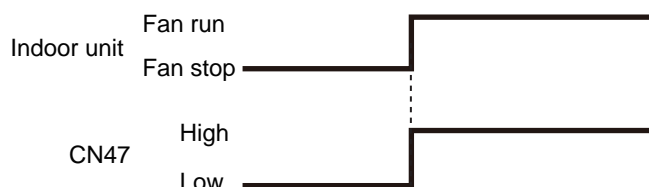

External heater output

Function setting	External output	Output signal	Command
60—11	CN47	Low → High	Heater on
		High → Low	Heater off

Output signal	Condition
Low → High	Heater turns on as shown in diagram of heating temperature
Off → On	
High → Low	Heater turns off as shown in diagram of heating temperature
On → Off	<ul style="list-style-type: none"> • Other than Heating mode • Error occurred • Forced thermo off • Fan stop protection

Specifications of the signal output performance are as shown as follows:

Example When set temperature (T_s) is set at 22 °C;

- And room temperature (T_r) increase above 12 °C, signal output is on.
- And T_r increase above 21 °C, signal output is off.
- And T_r decrease below 19 °C, signal output is on.
- And T_r decrease below 10 °C, signal output is off.

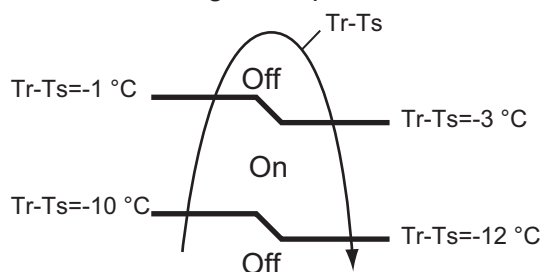

The output also turns off in defrost operation.