

8. External input and output

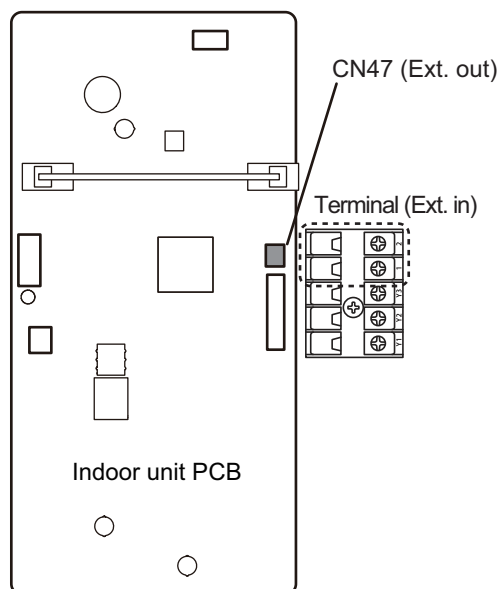

| External input and output | | Connector | Input select | Input signal | External connect kit (Optional parts) |
|---------------------------|----------------------------------|-----------|--------------|--------------|---------------------------------------|
| External input | Operation/Stop Forced stop | Terminal | Dry contact | Edge | — |
| External output | Operation status | CN47 | — | — | UTY-XWZXZG |
| | Error status | | | | |
| | Indoor unit fan operation status | | | | |
| | External heater output | | | | |

8-1. External input

- “Operation/Stop” mode or “Forced stop” mode can be selected with function setting of indoor unit.
- A twisted pair cable (22AWG) should be used. Maximum length of cable is 150 m.
- The wire connection should be separate from the power cable line.

Indoor unit functions such as Operation/Stop can be done by using indoor unit terminals.

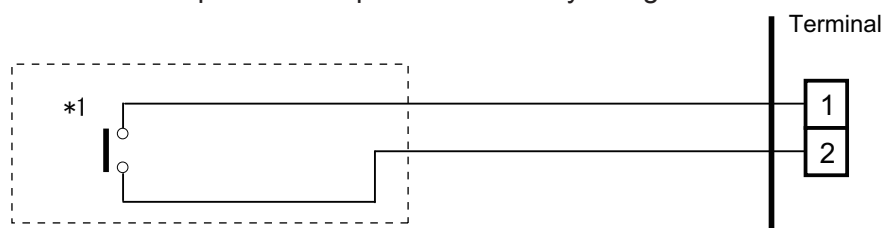

*1: The switch can be used on the following condition: DC 12 V to 24 V, 1 mA to 15 mA.

8-2. External output

Use an external output cable with appropriate external dimension, depending on the number of cables to be installed.

- A twisted pair cable (22AWG) should be used. Maximum length of cable is 25 m.
- Output voltage: High DC 12 V \pm 2 V, Low 0 V.
- Permissible current: 50 mA
- For details, refer to "[Combination of external input and output](#)" on page 16.

● When indicator, etc. are connected directly

Example: Function setting 60 is set to "00"

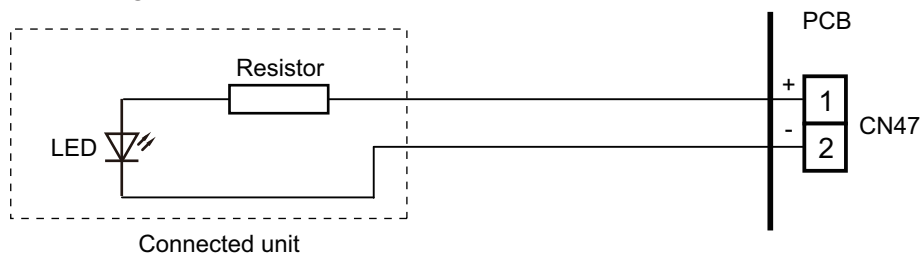

● When connecting with a device equipped with a power supply

Example: Function setting 60 is set to "00"

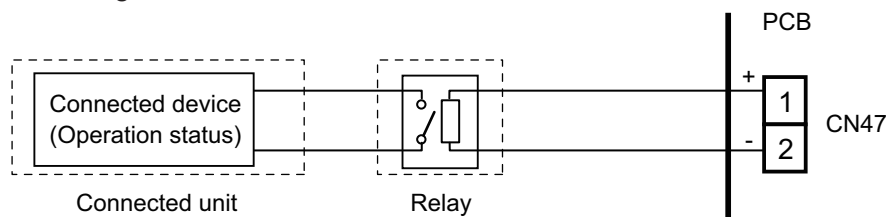

8-3. Combination of external input and output

By combining the function setting of the indoor unit, you can select various combinations of functions.

Combination examples of external input and output are as follows:

| Mode | Function setting | External input | External output |
|------|------------------|----------------------|----------------------------------|
| | | Terminal | CN47 |
| 0 | 60—00 | Operation/Stop | |
| 1—8 | 60—01 to 60—08 | (Setting prohibited) | |
| 9 | 60—09 | Operation/Stop | Error status |
| 10 | 60—10 | Operation/Stop | Indoor unit fan operation status |
| 11 | 60—11 | Operation/Stop | External heater output |

NOTE: Input of Operation/Stop depends on the setting of function setting 46.

- 00: Operation/Stop mode 1 (R.C. enabled)
- 01: (Setting prohibited)
- 02: Forced stop
- 03: Operation/Stop mode 2 (R.C. disabled)

■ Input signal type

- Indoor unit
Input signal type is only "Edge".



8-4. Details of function

■ Control input function

- When function setting is "Operation/Stop" mode 1

| Function setting | External input | Input signal | Command |
|------------------|----------------|--------------|-----------|
| 46—00 | Terminal | Off → On | Operation |
| | | On → Off | Stop |

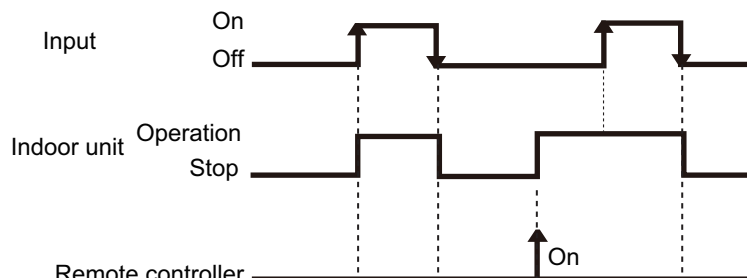

NOTES:

- The last command has priority.
- The indoor units within the same remote controller group operates in the same mode.

- When function setting is "Forced stop" mode

| Function setting | External input | Input signal | Command |
|------------------|----------------|--------------|-------------|
| 46—02 | Terminal | Off → On | Forced stop |
| | | On → Off | Normal |

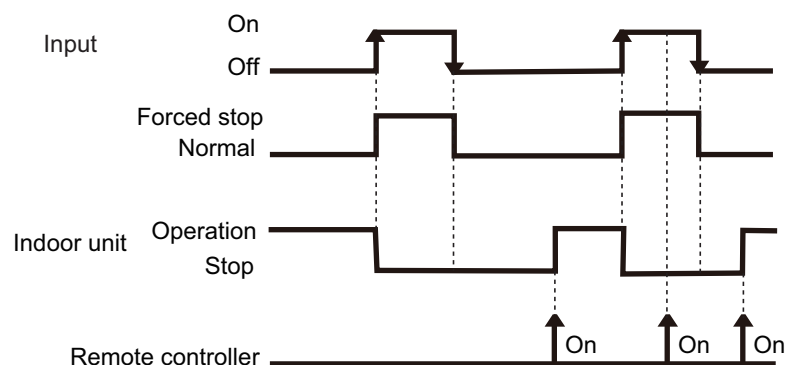

NOTES:

- When the forced stop is triggered, indoor unit stops and Operation/Stop operation by the remote controller is restricted.
- When forced stop function is used with forming a remote controller group, connect the same equipment to each indoor unit within the group.

- When function setting is "Operation/Stop" mode 2

| Function setting | External input | Input signal | Command |
|------------------|----------------|--------------|----------------------|
| 46—03 | Terminal | Off → On | Operation |
| | | On → Off | Stop (R.C. disabled) |

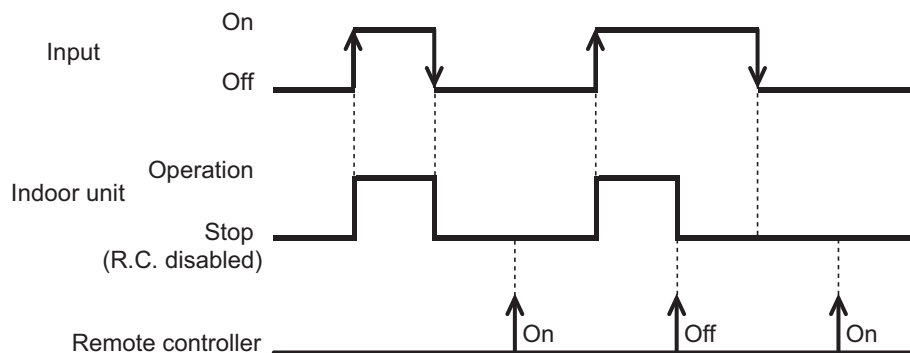

NOTE: When "Operation/Stop" mode 2 function is used with forming a remote controller group, connect the same equipment to each indoor unit within the group.

Control output function

| Function setting | External output | Output signal | Command |
|------------------|-----------------|---------------|-----------|
| 60—00 | CN47 | Low → High | Operation |
| | | High → Low | Stop |

The output is low when the unit is stopped.

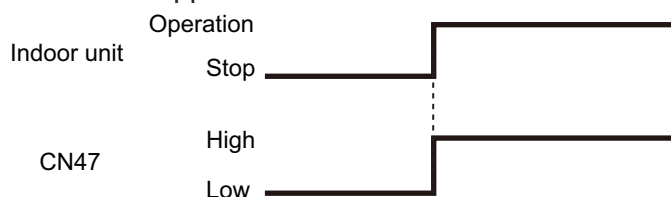

Error status

| Function setting | External output | Output signal | Command |
|------------------|-----------------|---------------|---------|
| 60—09 | CN47 | Low → High | Error |
| | | High → Low | Normal |

The output is ON when an error is generated for the indoor unit.

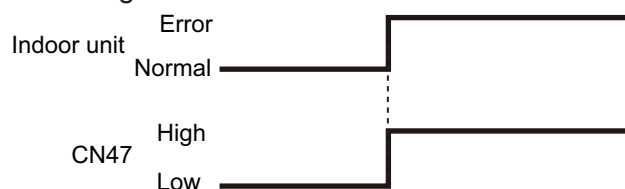

Indoor unit fan operation status

| Function setting | External output | Output signal | Command |
|------------------|-----------------|---------------|----------|
| 60—10 | CN47 | Low → High | Fan run |
| | | High → Low | Fan stop |

| Output signal | Condition |
|---------------|--|
| On | The indoor unit fan is operating. |
| Low → High | |
| Off | The fan is stopped or during cold air prevention. During thermostat off when in dry mode operation. |
| High → Low | |

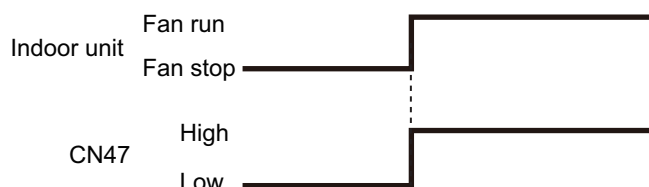

External heater output

| Function setting | External output | Output signal | Command |
|------------------|-----------------|---------------|------------|
| 60—11 | CN47 | Low → High | Heater on |
| | | High → Low | Heater off |

| Output signal | Condition |
|---------------|---|
| Low → High | Heater turns on as shown in diagram of heating temperature |
| Off → On | |
| High → Low | Heater turns off as shown in diagram of heating temperature |
| On → Off | <ul style="list-style-type: none"> • Other than Heating mode • Error occurred • Forced thermo off • Fan stop protection |

Specifications of the signal output performance are as shown as follows:

Example When set temperature (T_s) is set at 22 °C;

- And room temperature (T_r) increase above 12 °C, signal output is on.
- And T_r increase above 21 °C, signal output is off.
- And T_r decrease below 19 °C, signal output is on.
- And T_r decrease below 10 °C, signal output is off.

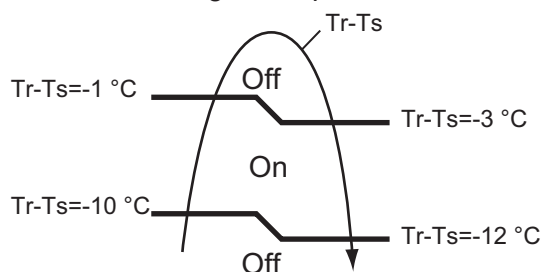

The output also turns off in defrost operation.