

# AIR CONDITIONER INDOOR UNIT (Duct type)

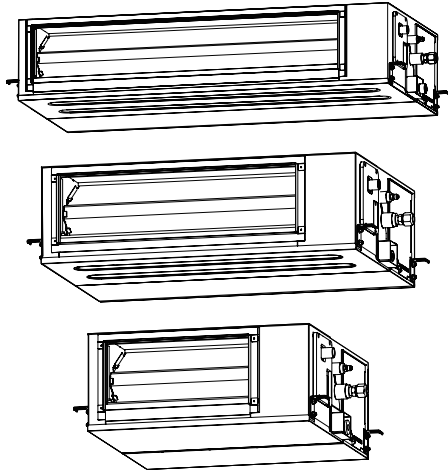

## Contents

1. SAFETY PRECAUTIONS .....	1
2. PRODUCT SPECIFICATION .....	4
2.1. Installation tools .....	4
2.2. Accessories .....	4
2.3. Pipe requirement .....	5
2.4. Electrical requirement .....	5
2.5. Optional parts .....	5
3. INSTALLATION WORK .....	5
3.1. Selecting an installation location .....	5
3.2. Installation dimension .....	6
3.3. Installing the unit .....	6
3.4. Intake duct connection .....	7
3.5. Drain installation .....	7
3.6. Pipe installation .....	8
3.7. Fresh air intake .....	9
3.8. Electrical wiring .....	10
3.9. Remote controller installation .....	11
4. OPTIONAL INSTALLATION WORK .....	11
4.1. Optional kit installation .....	11
4.2. External input and output .....	11
4.3. Remote sensor .....	12
5. REMOTE CONTROL INSTALLATION .....	12
5.1. Group control .....	12
5.2. Multiple remote control .....	13
5.3. DIP switch 101 setting .....	13
6. FUNCTION SETTING .....	13
6.1. Function details .....	13
6.2. Static pressure .....	14
7. CHECK LIST .....	15
8. TEST RUN .....	15
8.1. Check items .....	15
8.2. Operation method .....	15
9. FINISHING .....	15
10. CUSTOMER GUIDANCE .....	15
11. ERROR CODES .....	16

**NOTE:** This manual describes how to install the air conditioner described above. Handling and installation shall only be done by professionals as outlined in this manual.

## 1. SAFETY PRECAUTIONS

- Be sure to read this manual thoroughly before installation.
- The warnings and precautions indicated in this manual contain important information pertaining to your safety. Be sure to observe them.
- Hand this manual, together with the operating manual, to the customer. Request the customer to keep them on hand for future use, such as for relocating or repairing the unit.

# INSTALLATION MANUAL



PART No. 9381386215-02

[Original instructions]

For authorized service personnel only.

### ! WARNING

Indicates a potentially or imminently hazardous situation which, if not avoided, could result in death or serious injury.

### ! CAUTION

Indicates a potentially hazardous situation that may result in minor or moderate injury or damage to property.

### ! WARNING

- The appliance shall be installed, operated and stored in a room with a floor area larger than X m<sup>2</sup>.

Amount of refrigerant charge M (kg)	Minimum room area X (m <sup>2</sup> )
M ≤ 1.22	-
1.22 < M ≤ 1.23	1.45
1.23 < M ≤ 1.50	2.15
1.50 < M ≤ 1.75	2.92
1.75 < M ≤ 2.0	3.82
2.0 < M ≤ 2.5	5.96
2.5 < M ≤ 3.0	8.59
3.0 < M ≤ 3.5	11.68
3.5 < M ≤ 4.0	15.26

(IEC 60335-2-40)

- Installation of this product must be done by experienced service technicians or professional installers only in accordance with this manual. Installation by non-professional or improper installation of the product might cause serious accidents such as injury, water leakage, electric shock, or fire. If the product is installed in disregard of the instructions in this manual, it will void the manufacturer's warranty.
- Do not turn on the power until all work has been completed. Turning on the power before the work is completed can cause serious accidents such as electric shock or fire.
- If refrigerant leaks when you are working, ventilate the area. If the leaking refrigerant is exposed to a direct flame, it may produce a toxic gas.
- Installation must be performed in accordance with regulations, codes, or standards for electrical wiring and equipment in each country, region, or the installation place.
- Do not use means to accelerate the defrosting process or to clean, other than those recommended by the manufacturer.
- This appliance is not intended for use by persons (including children) with reduced physical, sensory or mental capabilities, or lack of experience and knowledge, unless they have been given supervision or instruction concerning use of the appliance by a person responsible for their safety. Children should be supervised to ensure that they do not play with the appliance.
- To avoid danger of suffocation, keep the plastic bag or thin film used as the packaging material away from young children.
- The appliance shall be stored in a room without continuously operating ignition sources (for example: open flames, an operating gas appliance or an operating electric heater).
- Do not pierce or burn.
- Be aware that refrigerants may not contain an odour.

English

Deutsch

Français

Español

Italiano

Ελληνικά

Português

Русский

Türkçe

**CAUTION**

- Read carefully all safety information written in this manual before you install or use the air conditioner.
- Install the product by following local codes and regulations in force at the place of installation, and the instructions provided by the manufacturer.
- This product is part of a set constituting an air conditioner. The product must not be installed alone or be installed with a device not authorized by the manufacturer.
- Always use a separate power supply line protected by a circuit breaker operating on all wires with a distance between contact of 3 mm for this product.
- To protect the persons, earth (ground) the product correctly, and use the power cable combined with an Earth Leakage Circuit Breaker (ELCB).
- This product is not explosion proof, and therefore should not be installed in an explosive atmosphere.
- To avoid getting an electric shock, never touch the electrical components soon after the power supply has been turned off. After turning off the power, always wait 5 minutes or more before you touch the electrical components.
- This product contains no user-serviceable parts. Always consult experienced service technicians for repairing.
- When moving or relocating the air conditioner, consult experienced service technicians for disconnection and reinstallation of the product.
- Do not touch the aluminum fins of heat exchanger built-in the indoor or outdoor unit to avoid personal injury when you install or maintain the unit.
- Do not place any other electrical products or household belongings under the product. Condensation dripping from the product might get them wet, and may cause damage or malfunction to the property.

- Be careful not to scratch the air conditioner when handling it.

**Precautions for using R32 refrigerant**

The basic installation work procedures are the same as conventional refrigerant (R410A, R22) models.

However, pay careful attention to the following points:

Since the working pressure is 1.6 times higher than that of refrigerant R22 models, some of the piping and installation and service tools are special. (See "2. 1. Installation tools".)

Especially, when replacing a refrigerant R22 model with a new refrigerant R32 model, always replace the conventional piping and flare nuts with the R32 and R410A piping and flare nuts on the outdoor unit side.

For R32 and R410A, the same flare nut on the outdoor unit side and pipe can be used.

Models that use refrigerant R32 and R410A have a different charging port thread diameter to prevent erroneous charging with refrigerant R22 and for safety. Therefore, check beforehand. [The charging port thread diameter for R32 and R410A is 1/2-20 UNF.]

Be more careful than R22 so that foreign matter (oil, water, etc.) does not enter the piping. Also, when storing the piping, securely seal the opening by pinching, taping, etc. (Handling of R32 is similar to R410A.)

**CAUTION**

1-Installation (Space)

- That the installation of pipe-work shall be kept to a minimum.
- That pipe-work shall be protected from physical damage.
- The appliance shall not be installed in an unventilated space, if that space is smaller than X m<sup>2</sup>.

Amount of refrigerant charge M (kg)	Minimum room area X (m <sup>2</sup> )
M ≤ 1.22	-
1.22 < M ≤ 1.23	1.45
1.23 < M ≤ 1.50	2.15
1.50 < M ≤ 1.75	2.92
1.75 < M ≤ 2.0	3.82
2.0 < M ≤ 2.5	5.96
2.5 < M ≤ 3.0	8.59
3.0 < M ≤ 3.5	11.68
3.5 < M ≤ 4.0	15.26

(IEC 60335-2-40)

- That compliance with national gas regulations shall be observed.
- That mechanical connections shall be accessible for maintenance purposes.
- In cases that require mechanical ventilation, ventilation openings shall be kept clear of obstruction.
- When disposing of the product is used, be based on national regulations, properly processed.

**CAUTION**

2- Servicing

2-1 Service personnel

- Any person who is involved with working on or breaking into a refrigerant circuit should hold a current valid certificate from an industry-accredited assessment authority, which authorises their competence to handle refrigerants safely in accordance with an industry recognised assessment specification.
- Servicing shall only be performed as recommended by the equipment manufacturer. Maintenance and repair requiring the assistance of other skilled personnel shall be carried out under the supervision of the person competent in the use of flammable refrigerants.
- Servicing shall be performed only as recommended by the manufacturer.

2-2 Work

- Prior to beginning work on systems containing flammable refrigerants, safety checks are necessary to ensure that the risk of ignition is minimized. For repair to the refrigerating system, the precautions in 2-2 to 2-8 shall be complied with prior to conducting work on the system.
- Work shall be undertaken under a controlled procedure so as to minimize the risk of a flammable gas or vapour being present while the work is being performed.
- All maintenance staff and others working in the local area shall be instructed on the nature of work being carried out.
- Work in confined spaces shall be avoided.
- The area around the workspace shall be sectioned off.
- Ensure that the conditions within the area have been made safe by control of flammable material.

2-3 Checking for presence of refrigerant

- The area shall be checked with an appropriate refrigerant detector prior to and during work, to ensure the technician is aware of potentially flammable atmospheres.
- Ensure that the leak detection equipment being used is suitable for use with flammable refrigerants, i.e. nonsparking, adequately sealed or intrinsically safe.

2-4 Presence of fire extinguisher

- If any hot work is to be conducted on the refrigeration equipment or any associated parts, appropriate fire extinguishing equipment shall be available at hand.
- Have a dry powder or CO<sub>2</sub> fire extinguisher adjacent to the charging area.

2-5 No ignition sources

- No person carrying out work in relation to a refrigeration system which involves exposing any pipe work that contains or has contained flammable refrigerant shall use any sources of ignition in such a manner that it may lead to the risk of fire or explosion.
- All possible ignition sources, including cigarette smoking, should be kept sufficiently far away from the site of installation, repairing, removing and disposal, during which flammable refrigerant can possibly be released to the surrounding space.
- Prior to work taking place, the area around the equipment is to be surveyed to make sure that there are no flammable hazards or ignition risks. "No Smoking" signs shall be displayed.

2-6 Ventilated area

- Ensure that the area is in the open or that it is adequately ventilated before breaking into the system or conducting any hot work.
- A degree of ventilation shall continue during the period that the work is carried out.
- The ventilation should safely disperse any released refrigerant and preferably expel it externally into the atmosphere.

2-7 Checks to the refrigeration equipment

- Where electrical components are being changed, they shall be fit for the purpose and to the correct specification.
- At all times the manufacturer's maintenance and service guidelines shall be followed.
- If in doubt consult the manufacturer's technical department for assistance.
- The following checks shall be applied to installations using flammable refrigerants.
  - The charge size is in accordance with the room size within which the refrigerant containing parts are installed.
  - The ventilation machinery and outlets are operating adequately and are not obstructed.
  - If an indirect refrigerating circuit is being used, the secondary circuit shall be checked for the presence of refrigerant.
  - Marking to the equipment continues to be visible and legible. Markings and signs that are illegible shall be corrected.
  - Refrigeration pipe or components are installed in a position where they are unlikely to be exposed to any substance which may corrode refrigerant containing components, unless the components are constructed of materials which are inherently resistant to being corroded or are suitably protected against being so corroded.

 **CAUTION**

**2-8 Checks to electrical devices**

- Repair and maintenance to electrical components shall include initial safety checks and component inspection procedures.
- If a fault exists that could compromise safety, then no electrical supply shall be connected to the circuit until it is satisfactorily dealt with.
- If the fault cannot be corrected immediately but it is necessary to continue operation, an adequate temporary solution shall be used.
- This shall be reported to the owner of the equipment so all parties are advised.
- Initial safety checks shall include:
  - That capacitors are discharged: this shall be done in a safe manner to avoid possibility of sparking.
  - That there no live electrical components and wiring are exposed while charging, recovering or purging the system.
  - That there is continuity of earth bonding.

**3-Repairs to sealed components**

- During repairs to sealed components, all electrical supplies shall be disconnected from the equipment being worked upon prior to any removal of sealed covers, etc.
- If it is absolutely necessary to have an electrical supply to equipment during servicing, then a permanently operating form of leak detection shall be located at the most critical point to warn of a potentially hazardous situation.
- Particular attention shall be paid to the following to ensure that by working on electrical components, the casing is not altered in such a way that the level of protection is affected.
- This shall include damage to cables, excessive number of connections, terminals not made to original specification, damage to seals, incorrect fitting of glands, etc.
- Ensure that apparatus is mounted securely.
- Ensure that seals or sealing materials have not degraded such that they no longer serve the purpose of preventing the ingress of flammable atmospheres.
- Replacement parts shall be in accordance with the manufacturer's specifications.

NOTE: The use of silicon sealant may inhibit the effectiveness of some types of leak detection equipment.  
Intrinsically safe components do not have to be isolated prior to working on them.

**4-Repair to intrinsically safe components**

- Do not apply any permanent inductive or capacitance loads to the circuit without ensuring that this will not exceed the permissible voltage and current permitted for the equipment in use.
- Intrinsically safe components are the only types that can be worked on while live in the presence of a flammable atmosphere.
- The test apparatus shall be at the correct rating.
- Replace components only with parts specified by the manufacturer.
- Other parts may result in the ignition of refrigerant in the atmosphere from a leak.

**5-Cabling**

- Check that cabling will not be subject to wear, corrosion, excessive pressure, vibration, sharp edges or any other adverse environmental effects.
- The check shall also take into account the effects of aging or continual vibration from sources such as compressors or fans.

**6-Detection of flammable refrigerants**

- Under no circumstances shall potential sources of ignition be used in the searching for or detection of refrigerant leaks.
- A halide torch (or any other detector using a naked flame) shall not be used.

**7-Leak detection methods**

- Electronic leak detectors shall be used to detect flammable refrigerants, but the sensitivity may not be adequate, or may need re-calibration. (Detection equipment shall be calibrated in a refrigerant-free area.)
- Ensure that the detector is not a potential source of ignition and is suitable for the refrigerant used.
- Leak detection equipment shall be set at a percentage of the LFL of the refrigerant and shall be calibrated to the refrigerant employed and the appropriate percentage of gas (25 % maximum) is confirmed.
- Leak detection fluids are suitable for use with most refrigerants but the use of detergents containing chlorine shall be avoided as the chlorine may react with the refrigerant and corrode the copper pipe-work.
- If a leak is suspected, all naked flames shall be removed/extinguished.
- If a leakage of refrigerant is found which requires brazing, all of the refrigerant shall be recovered from the system, or isolated (by means of shut off valves) in a part of the system remote from the leak.  
Oxygen free nitrogen (OFN) shall then be purged through the system both before and during the brazing process.

 **CAUTION**

**8-Removal and evacuation**

- When breaking into the refrigerant circuit to make repairs – or for any other purpose –conventional procedures shall be used.  
However, it is important that best practice is followed since flammability is a consideration.  
The following procedure shall be adhered to:
  - remove refrigerant
  - purge the circuit with inert gas
  - evacuate
  - purge again with inert gas
  - open the circuit by cutting or brazing
- The refrigerant charge shall be recovered into the correct recovery cylinders.
- The system shall be "flushed" with OFN to render the unit safe.
- This process may need to be repeated several times.
- Compressed air or oxygen shall not be used for this task.
- Flushing shall be achieved by breaking the vacuum in the system with OFN and continuing to fill until the working pressure is achieved, then venting to atmosphere, and finally pulling down to a vacuum.
- This process shall be repeated until no refrigerant is within the system.
- When the final OFN charge is used, the system shall be vented down to atmospheric pressure to enable work to take place.
- This operation is absolutely vital if brazing operations on the pipe work are to take place.
- Ensure that the outlet for the vacuum pump is not close to any ignition sources and there is ventilation available.

**9-Charging procedures**

- In addition to conventional charging procedures, the following requirements shall be followed.
  - Ensure that contamination of different refrigerants does not occur when using charging equipment.  
Hoses or lines shall be as short as possible to minimize the amount of refrigerant contained in them.
  - Cylinders shall be kept upright.
  - Ensure that the refrigeration system is earthed prior to charging the system with refrigerant.
  - Label the system when charging is complete (if not already).
  - Extreme care shall be taken not to overfill the refrigeration system.
- Prior to recharging the system it shall be pressure tested with OFN.
- The system shall be leak tested on completion of charging but prior to commissioning.
- A follow up leak test shall be carried out prior to leaving the site.

**10-Decommissioning**

- Before carrying out this procedure, it is essential that the technician is completely familiar with the equipment and all its details.
- It is recommended good practice that all refrigerants are recovered safely.
- Prior to the task being carried out, an oil and refrigerant sample shall be taken in case analysis is required prior to re-use of reclaimed refrigerant.
- It is essential that electrical power is available before the task is commenced.
  - a) Become familiar with the equipment and its operation.
  - b) Isolate system electrically.
  - c) Before attempting the procedure ensure that:
    - mechanical handling equipment is available, if required, for handling refrigerant cylinders;
    - all personal protective equipment is available and being used correctly;
    - the recovery process is supervised at all times by a competent person;
    - recovery equipment and cylinders conform to the appropriate standards.
  - d) Pump down refrigerant system, if possible.
  - e) If a vacuum is not possible, make a manifold so that refrigerant can be removed from various parts of the system.
  - f) Make sure that cylinder is situated on the scales before recovery takes place.
  - g) Start the recovery machine and operate in accordance with manufacturer's instructions.
  - h) Do not overfill cylinders. (No more than 80 % volume liquid charge).
  - i) Do not exceed the maximum working pressure of the cylinder, even temporarily.
  - j) When the cylinders have been filled correctly and the process completed, make sure that the cylinders and the equipment are removed from site promptly and all isolation valves on the equipment are closed off.
  - k) Recovered refrigerant shall not be charged into another refrigeration system unless it has been cleaned and checked.

**11- Labelling**





- Equipment shall be labelled stating that it has been de-commissioned and emptied of refrigerant.
- The label shall be dated and signed.
- Ensure that there are labels on the equipment stating the equipment contains flammable refrigerant.

**CAUTION**

12-Recovery

- When removing refrigerant from a system, either for servicing or decommissioning, it is recommended good practice that all refrigerants are removed safely.
- When transferring refrigerant into cylinders, ensure that only appropriate refrigerant recovery cylinders are employed.
- Ensure that the correct number of cylinders for holding the total system charge are available.
- All cylinders to be used are designated for the recovered refrigerant and labelled for that refrigerant (i.e. special cylinders for the recovery of refrigerant).
- Cylinders shall be complete with pressure relief valve and associated shut-off valves in good working order.
- Empty recovery cylinders are evacuated and, if possible, cooled before recovery occurs.
- The recovery equipment shall be in good working order with a set of instructions concerning the equipment that is at hand and shall be suitable for the recovery of flammable refrigerants.
- In addition, a set of calibrated weighing scales shall be available and in good working order.
- Hoses shall be complete with leak-free disconnect couplings and in good condition.
- Before using the recovery machine, check that it is in satisfactory working order, has been properly maintained and that any associated electrical components are sealed to prevent ignition in the event of a refrigerant release.  
Consult manufacturer if in doubt.
- The recovered refrigerant shall be returned to the refrigerant supplier in the correct recovery cylinder, and the relevant Waste Transfer Note arranged.
- Do not mix refrigerants in recovery units and especially not in cylinders.
- If compressors or compressor oils are to be removed, ensure that they have been evacuated to an acceptable level to make certain that flammable refrigerant does not remain within the lubricant.
- The evacuation process shall be carried out prior to returning the compressor to the suppliers.
- Only electric heating to the compressor body shall be employed to accelerate this process.
- When oil is drained from a system, it shall be carried out safely.

Explanation of symbols displayed on the indoor unit or outdoor unit.

	<b>WARNING</b>	This symbol shows that this appliance uses a flammable refrigerant. If the refrigerant is leaked and exposed to an external ignition source, there is a risk of fire.
	<b>CAUTION</b>	This symbol shows that the operation manual should be read carefully.
	<b>CAUTION</b>	This symbol shows that a service personnel should be handling this equipment with reference to the installation manual.
	<b>CAUTION</b>	This symbol shows that information is available such as the operating manual or installation manual.

**2. PRODUCT SPECIFICATION**

**2.1. Installation tools**

Tool name	Change from R22 to R32 (R410A)
<b>Gauge manifold</b>	Pressure is high and cannot be measured with a R22 gauge. To prevent erroneous mixing of other refrigerants, the diameter of each port has been changed. It is recommended to use gauge with seals -0.1 to 5.3 MPa (-1 to 53 bar) for high pressure. -0.1 to 3.8 MPa (-1 to 38 bar) for low pressure.
<b>Charge hose</b>	To increase pressure resistance, the hose material and base size were changed. (R32/R410A)
<b>Vacuum pump</b>	A conventional vacuum pump can be used by installing a vacuum pump adapter. (Use of a vacuum pump with a series motor is prohibited.)
<b>Gas leakage detector</b>	Special gas leakage detector for HFC refrigerant R410A or R32.

**Copper pipes**

It is necessary to use seamless copper pipes and it is desirable that the amount of residual oil is less than 40 mg/10 m. Do not use copper pipes having a collapsed, deformed or discolored portion (especially on the interior surface). Otherwise, the expansion valve or capillary tube may become blocked with contaminants.  
As an air conditioner using R32 (R410A) incurs pressure higher than when using R22, it is necessary to choose adequate materials.

**WARNING**

- Do not use the existing (for R22) piping and flare nuts.  
If the existing materials are used, the pressure inside the refrigerant cycle will rise and cause failure, injury, etc. (Use the special R32/R410A materials.)
- Use (refill or replace with) specified refrigerant (R32) only. Use of unspecified refrigerant can cause product malfunction, burst, or injury.
- Do not mix any gas or impurities except specified refrigerant (R32). Inflow of air or application of unspecified material makes the internal pressure of the refrigerant cycle too high, and may cause product malfunction, burst of piping, or injury.
- For installation purposes, be sure to use the parts supplied by the manufacturer or other prescribed parts. The use of non-prescribed parts can cause serious accidents such as the unit falling, water leakage, electric shock, or fire.
- Do not turn on the power until all work has been completed.

**CAUTION**











This manual describes how to install the indoor unit only. To install the outdoor unit or branch box, (if any), refer to the installation manual included in each product.

**2.2. Accessories**

**WARNING**

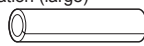
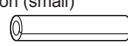
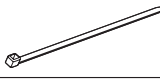
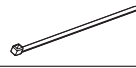
For installation purposes, be sure to use the parts supplied by the manufacturer or other prescribed parts.  
The use of non-prescribed parts can cause serious accidents such as the unit falling, water leakage, electric shock, or fire.

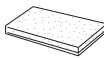
- The following installation parts are furnished. Use them as required.
- Keep the Installation Manual in a safe place and do not discard any other accessories until the installation work has been completed.

Name and Shape	Q'ty	Description
Operating Manual 	1	
Operating Manual (CD-ROM) 	1	
Installation Manual (indoor unit) 	1	(This book)
Special nut A (large flange) 	4	For suspending the indoor unit from ceiling
Special nut B (small flange) 	4	
Washer 	8	
Coupler heat insulation (large) 	1	For indoor side pipe joint (gas pipe)
Coupler heat insulation (small) 	1	For indoor side pipe joint (liquid pipe)
Cable tie (large) 	4	For fixing the heat insulation
Cable tie (medium) 	1	For fixing the remote controller cable
Cable tie (small) 	1	For fixing the remote controller cable
Drain hose insulation 	1	Insulates the drain hose and vinyl hose
Drain hose 	1	For installing drain pipe VP25 (O.D.32, I.D.25)
Hose Band 	1	For installing drain hose



## 2. 3. Pipe requirement

### CAUTION

Refer to the installation manual of the outdoor unit for description of the length of connecting pipe or for difference of its elevation.

Model	Diameter [mm (in)]	
	Gas pipe	Liquid pipe
12/14	9.52 (3/8)	6.35 (1/4)
18/22/24	12.70 (1/2)	6.35 (1/4)
30/36/45/54	15.88 (5/8)	9.52 (3/8)

- Use pipe with water-resistant heat insulation.

### CAUTION

- Wrap heat insulation around both gas pipe and liquid pipe. No heat-insulation work or incorrect heat-insulation work may cause water leaks.
- In a reverse cycle model, use heat insulation with heat resistance above 120 °C.
- If expected humidity of the installation location of refrigerant pipes is higher than 70 %, wrap the heat insulation around the refrigerant pipes. If the expected humidity is between 70 % and 80 %, use heat insulation that has a thickness of 15 mm or more. If the expected humidity is higher than 80 %, use heat insulation that has a thickness of 20 mm or more.
- The use of thinner heat insulation than specified above, may cause a condensation on the surface of the insulation.
- Use heat insulation with thermal conductivity of 0.045 W/(m·K) or less, at 20 °C.

## 2. 4. Electrical requirement

The indoor unit is powered from the outdoor unit. Do not power indoor unit from separate power source.

### WARNING

Standard for electrical wiring and equipment differs in each country or region. Before you start electrical working, confirm related regulations, codes, or standards.

Cable	Conductor size (mm <sup>2</sup> )	Type	Remarks
Connection cable	1.5 (MIN.)	Type 60245 IEC57	3Wire+Earth (Ground), 1φ 230V

Cable Length: Limit voltage drop to less than 2%. Increase cable gauge if voltage drop is 2% or more.

Cable	Conductor size (mm <sup>2</sup> )	Type	Remarks
Remote controller cable (2-wire type)	0.33 to 1.25	Sheathed PVC cable	Non-polar 2-wired, twisted pair
Remote controller cable (3-wire type)	0.33	Sheathed PVC cable	Polar 3-wired

## 2. 5. Optional parts

Refer to each installation manual for the method of installing optional parts.

Parts name	Model No.	Application
Wired remote controller	UTY-RNR*Z*	For air conditioner operation (2-wired type)
	UTY-RLR*	
	UTY-RVN*M	For air conditioner operation (3-wired type)
	UTY-RNN*M	
W-LAN interface	UTY-TFSXZ1	For wireless LAN control
IR receiver unit	UTY-LBT*M	For air conditioner operation
Remote sensor	UTY-XSZX	Room temperature sensor
External input and output PCB	UTY-XCSX	For connecting external devices

External input and output PCB bracket	UTZ-GXNA	For installing the External input and output PCB
External connect kit	UTY-XWZXZG	For control output port
Air filter kit	UTD-LFNA/B/C	LFNA : 36/45/54 model LFNB : 18/22/24/30 model LFNC : 12/14 model

## 3. INSTALLATION WORK

### WARNING

- Do not turn on the power until all installation work is complete.
- Carrying and installation of the unit should be performed by a sufficient number of people and with sufficient equipment that is adequate for the weight of the unit. Performing such work with an insufficient number of people or with inadequate equipment could result in dropping of the unit or personal injury.

### CAUTION

For installation details, refer to the technical data.

### 3. 1. Selecting an installation location

Decide the mounting position together with the customer as follows.

### WARNING

Install the indoor unit where is capable to support the weight of the unit. Secure the unit firmly so that the unit does not topple or fall.

### CAUTION

- Do not install the unit in the following areas:
- Area with high salt content, such as at the seaside. It will deteriorate metal parts, causing the parts to fail or the unit to leak water.
  - Area filled with mineral oil or containing a large amount of splashed oil or steam, such as a kitchen. It will deteriorate plastic parts, causing the parts to fail or the unit to leak water.
  - Area where is close to heat sources.
  - Area that generates substances that adversely affect the equipment, such as sulfuric gas, chlorine gas, acid, or alkali. It will cause the copper pipes and brazed joints to corrode, which can cause refrigerant leakage.
  - Area that can cause combustible gas to leak, contains suspended carbon fibers or flammable dust, or volatile in flammables such as paint thinner or gasoline.
  - If gas leaks and settles around the unit, it can cause a fire.
  - Area where animals may urinate on the unit or ammonia may be generated.

- Do not use the unit for special purposes, such as storing food, raising animals, growing plants, or preserving precision devices or art objects. It can degrade the quality of the preserved or stored objects.
- Install the unit where drainage does not cause any trouble.
- Install the indoor unit, outdoor unit, power supply cable, transmission cable, and remote control cable at least 1 m away from a television or radio receivers. The purpose of this is to prevent TV reception interference or radio noise. (Even if they are installed more than 1 m apart, you could still receive noise under some signal conditions.)
- If children under 10 years old may approach the unit, take preventive measures so that they cannot reach the unit.
- Install the unit where ambient temperature does not reach 60°C or more. Take a measure such as ventilation for an environment in which heat is retained.

- (1) The inlet and outlet ports should not be obstructed; the air should be able to blow all over the room.
- (2) Leave the space required to service the air conditioner.
- (3) Install the unit where connection to the outdoor unit is easy.
- (4) Install the unit where the connection pipe can be easily installed.
- (5) Install the unit where the drain pipe can be easily installed.
- (6) Install the unit where noise and vibrations are not amplified.
- (7) Take servicing, etc., into consideration and leave the spaces. Also install the unit where the filter can be removed.
- (8) Do not install the unit where it will be exposed to direct sunlight.

Correct initial installation location is important because it is difficult to move unit after it is installed.

### 3.2. Installation dimension

Unit: mm

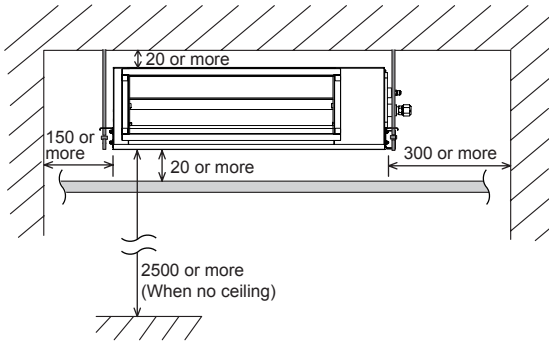

Provide a service access for maintenance purposes.

(Bottom side)

Unit: mm

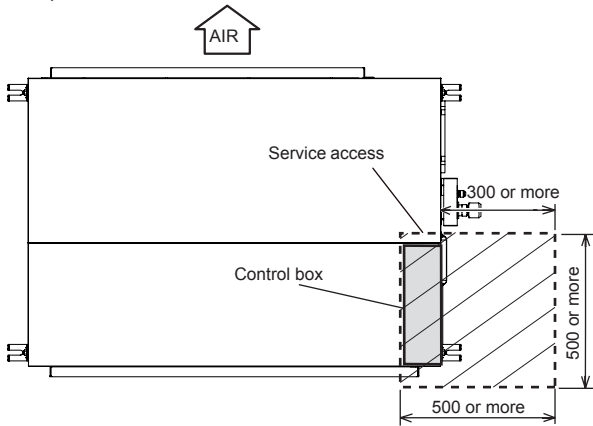

\* The service access necessary for fan units and filter maintenance.

(Bottom side)

Unit: mm

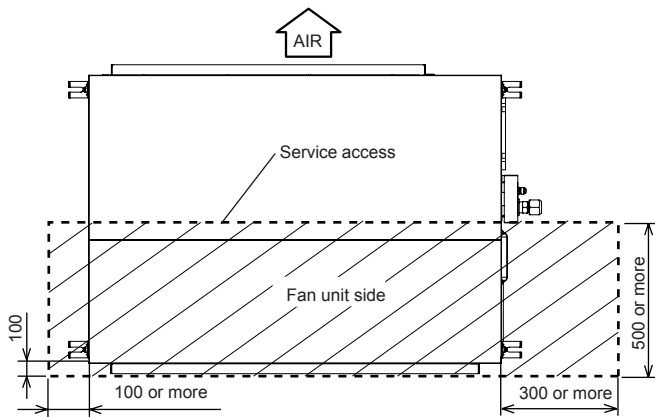

### 3.3. Installing the unit

#### ! WARNING

- Carrying and installation of the unit should be performed by a sufficient number of people and with sufficient equipment that is adequate for the weight of the unit. Performing such work with an insufficient number of people or with inadequate equipment could result in dropping of the unit or personal injury.
- If the job is done with the panel frame only, there is a risk that the unit will come loose. Please take care.
- When fastening the hangers, make the bolt positions uniform.

#### ! CAUTION

Confirm the directions of the air intake and outlet before installing the unit.

### 3.3.1. Position the ceiling hole

Hanging bolt installation diagram.

Unit: mm

(Top side)

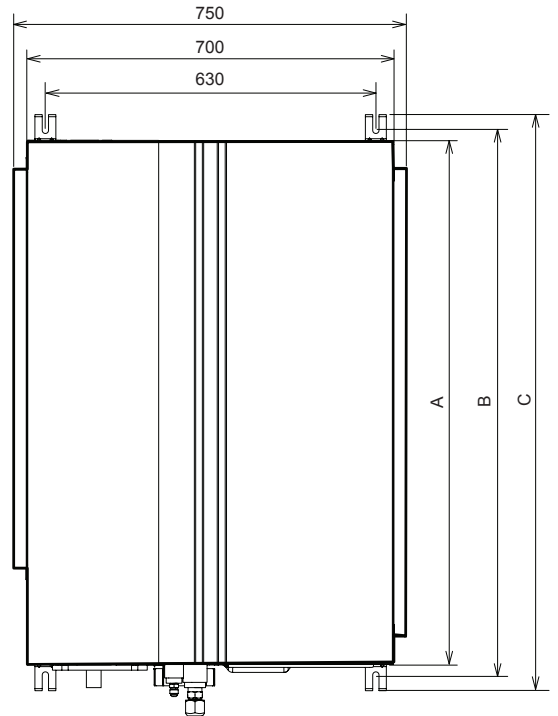

Model	Dimension (mm)		
	A	B	C
12/14	700	740	800
18/22/24/30	1000	1040	1100
36/45/54	1400	1440	1500

(Right side)

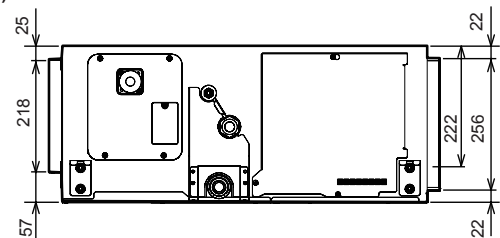

### 3.3.2. Body installation

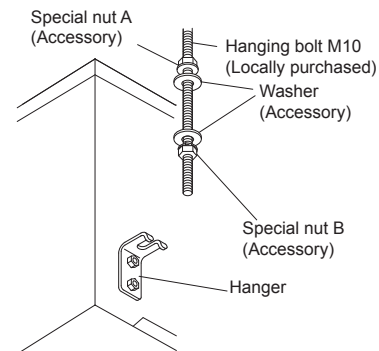

<b>Bolt Strength</b>	9.81 to 14.71 N·m (100 to 150 kgf·cm)
----------------------	---------------------------------------

**CAUTION**

Fasten the unit securely with special nuts A and B so that the unit does not fall.

**3.3.3. Leveling**

Base vertical direction leveling on the unit (right and left).

(Right side)

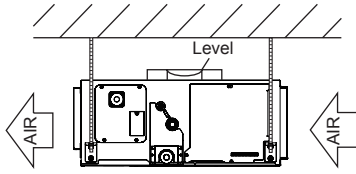

Base horizontal direction leveling on top of the unit.

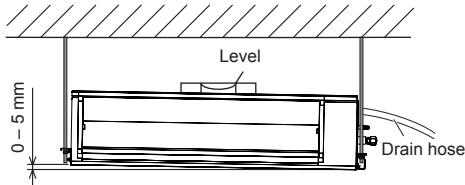

Give a slight tilt to the side to which the drain hose is connected. The tilt should be in the range of 0 mm to 5 mm.

**3.4. Intake duct connection**

Follow the procedure in the following figure.  
\*12/14/36/45/54 model is different from the figure.  
(Back side)

- 12/14 model : 700 mm
- 18/22/24/30 model : 1000 mm
- 36/45/54 model : 1400 mm

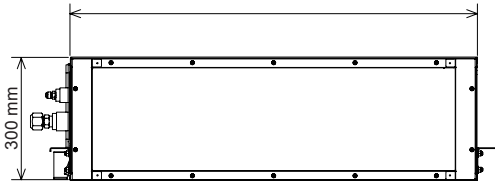

The air inlet duct can be changed by replacing the intake grille and service panel.

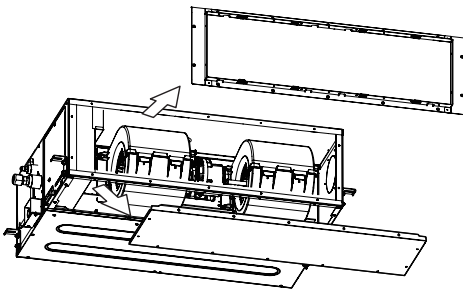

For the bottom air intake, position (1) the intake grille, and (2) the service panel, as shown in the following figure. (The factory setting is back air intake.)

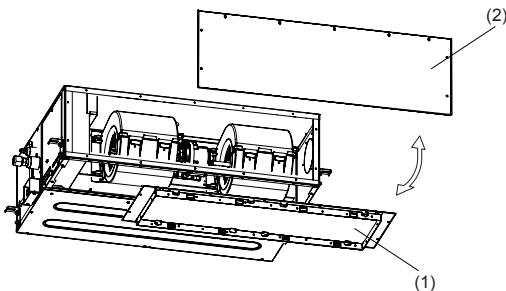

**CAUTION**

- Make sure the drain water is properly drained.
- To prevent people from touching the parts inside the unit, be sure to install grilles on the inlet and outlet ports. The grilles must be designed in such a way that cannot be removed without tools.
- Set the appropriate external static pressure within the permissible range. (Refer to "6. FUNCTION SETTING")
- If an intake duct is installed, take care not to damage the temperature sensor (the temperature sensor is attached to the intake port flange).
- Be sure to Install the air inlet grille and air outlet grille for air circulation. The correct temperature cannot be detected.

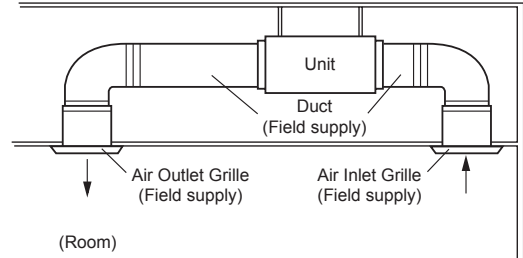

- When connecting the duct, perform duct-insulation appropriate for the installing environment. Inappropriate insulation work may cause condensation on the surface of the insulating material, and may lead to condensation dripping.

**3.5. Drain installation**

**CAUTION**

- Install the drain hose in accordance with the instructions in this installation manual and keep the area warm enough to prevent condensation. Problems with the piping may lead to water leaks.
- Be sure to properly insulate the drain hose so that the water will not drip from the connected parts.
- The position of the installed drain hose should have a downward gradient of 1/100 or more.
- Do not connect the drain hose in which ammonia or other types of gas affecting the unit is generated. Heat exchange erosion may occur.

Install the drain hose according to the measurements given in the following figure.

Unit: mm

(Right side)

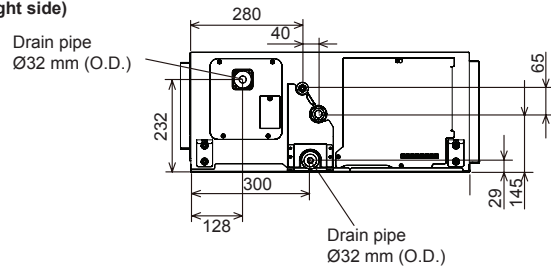

**3.5.1. Installing the drain hose**

- (1) Install the drain hose (accessory) to the drain port of the indoor unit. Attach the hose band around the hose within the dimension shown. Secure firmly with the hose band.
- (2) Attach the drain pipe (locally purchased). Use general hard polyvinyl chloride pipe (VP25) [outside diameter 32 mm] and connect it with adhesive (polyvinyl chloride) so that there is no leakage.
- (3) Check the drainage.
- (4) Wrap the drain hose insulation around the drain hose connection.

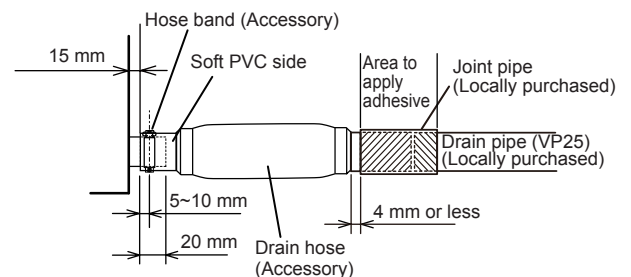

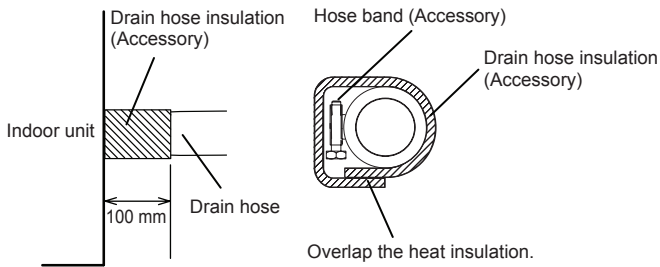

■ When drain pump is used

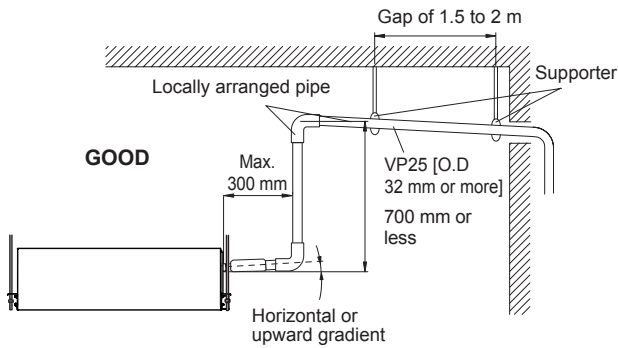

GOOD

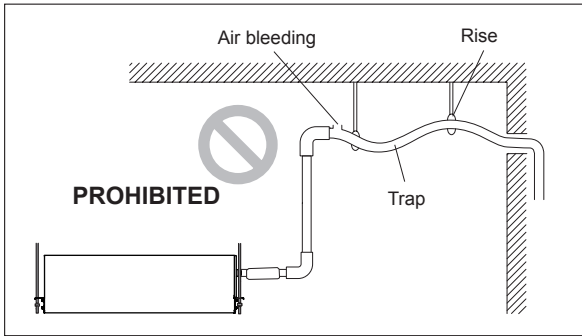

Observe the following procedures to construct centralized drain pipe fittings.

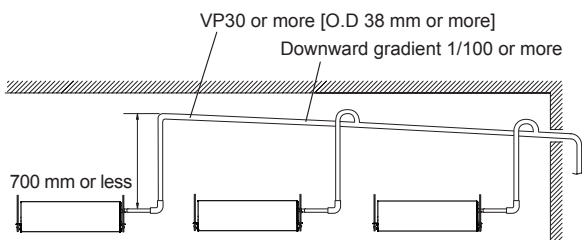

■ When drain pump is not used (Natural drainage)

If the drain pump is not used, please move the position of the drain cap and insulation.

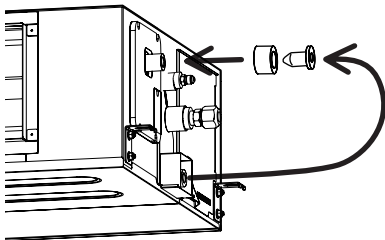

NOTE:

- Install the drain pipe with downward gradient (1/50 to 1/100) and so there are no rises or traps in the pipe.

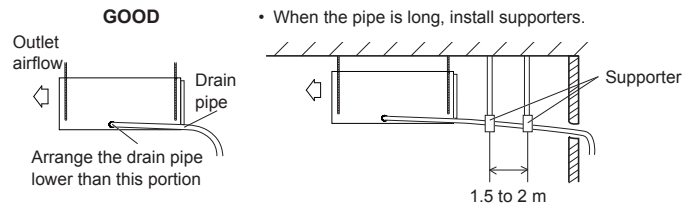

- When the pipe is long, install supporters.

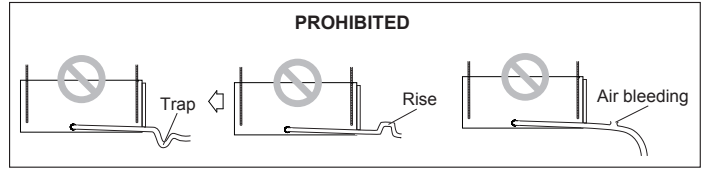

3. 5. 2. Check for drainage

Pour about 1 liter of water from the position shown in the diagram or from the airflow outlet to the dew tray. Check for any abnormalities such as strange noises and whether the drain pump functions normally.

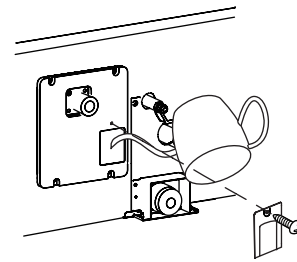

⚠ CAUTION

Make sure the drain water is properly drained.

3. 6. Pipe installation

⚠ WARNING

- During installation, make sure that the refrigerant pipe is attached firmly before you run the compressor. Do not operate the compressor under the condition of refrigerant piping not attached properly with 2-way or 3-way valve open. This may cause abnormal pressure in the refrigeration cycle that leads to breakage and even injury.
- During the pump-down operation, make sure that the compressor is turned off before you remove the refrigerant piping. Do not remove the connection pipe while the compressor is in operation with 2-way or 3-way valve open. This may cause abnormal pressure in the refrigeration cycle that leads to breakage and even injury.
- When installing and relocating the air conditioner, do not mix gases other than the specified refrigerant (R32) to enter the refrigerant cycle. If air or other gas enters the refrigerant cycle, the pressure inside the cycle will rise to an abnormally high value and cause breakage, injury, etc.
- If refrigerant leaks while work is being carried out, ventilate the area. If the refrigerant comes in contact with a flame, it produces a toxic gas.

⚠ CAUTION

- Be more careful so that foreign matter (oil, water, etc.) does not enter the piping than with refrigerant R32 models. Also, when storing the piping, securely seal the openings by pinching, taping, etc.
- While brazing the pipes, be sure to blow dry nitrogen gas through them.



### 3. 6. 1. Pipe connection

#### ■ Flaring

Use special pipe cutter and flare tool designed for R410A or R32 pipework.

- (1) Cut the connection pipe to the necessary length with a pipe cutter.
- (2) Hold the pipe downward so that cuttings will not enter the pipe and remove any burrs.
- (3) Insert the flare nut (always use the flare nut attached to the indoor unit(s) and outdoor unit or branch box respectively) onto the pipe and perform the flare processing with a flare tool. Use the special R410A or R32 flare tool, or the conventional flare tool. Leakage of refrigerant may result if other flare nuts are used.
- (4) Protect the pipes by pinching them or with tape to prevent dust, dirt, or water from entering the pipes.

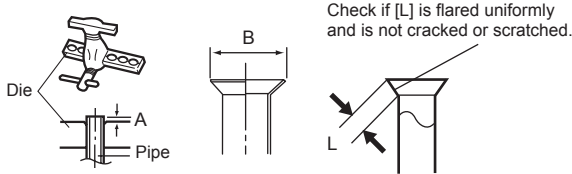

Pipe outside diameter [mm (in.)]	Dimension A [mm]	Dimension B <sub>0.4</sub> [mm]
	Flare tool for R32, clutch type	
6.35 (1/4)	0 to 0.5	9.1
9.52 (3/8)		13.2
12.70 (1/2)		16.6
15.88 (5/8)		19.7
19.05 (3/4)		24.0

When using conventional flare tools to flare R32 pipes, the dimension A should be approximately 0.5 mm more than indicated in the table (for flaring with R32 flare tools) to achieve the specified flaring. Use a thickness gauge to measure the dimension A.

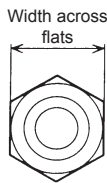

Pipe outside diameter [mm (in.)]	Width across flats of Flare nut [mm]
6.35 (1/4)	17
9.52 (3/8)	22
12.70 (1/2)	26
15.88 (5/8)	29
19.05 (3/4)	36

**NOTE:** The flare nut specification is compliant with ISO14903.

#### ■ Bending pipes

- If pipes are shaped by hand, be careful not to collapse them.
- Do not bend the pipes in an angle more than 90°.
- When pipes are repeatedly bend or stretched, the material will harden, making it difficult to bend or stretch them any more.
- Do not bend or stretch the pipes more than 3 times.

#### ⚠ CAUTION

- To prevent breaking of the pipe, avoid sharp bends. Bend the pipe with a radius of curvature of 150 mm or over.
- If the pipe is bent repeatedly at the same place, it will break.

#### ■ Flare connection

#### ⚠ CAUTION

- Be sure to apply the pipe against the port on the indoor unit correctly. If the centering is improper, the flare nut cannot be tightened smoothly. If the flare nut is forced to turn, the threads will be damaged.
- Do not remove the flare nut from the indoor unit pipe until immediately before connecting the connection pipe.
- Do not use mineral oil on flared part. Prevent mineral oil from getting into the system as this would reduce the lifetime of the units.

- (1) Detach the caps and plugs from the pipes.
- (2) Centering the pipe against port on the indoor unit, turn the flare nut with your hand.
- (3) When the flare nut is tightened properly by your hand, hold the body side coupling with a separate spanner, then tighten with a torque wrench. (See the table below for the flare nut tightening torques.)

#### ⚠ CAUTION

- Hold the torque wrench at its grip, keeping it in the right angle with the pipe, in order to tighten the flare nut correctly.
- Tighten the flare nuts with a torque wrench using the specified tightening method. Otherwise, the flare nuts could break after a prolonged period, causing refrigerant to leak and generate a hazardous gas if the refrigerant comes into contact with a flame.

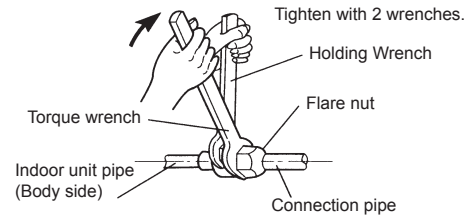

Flare nut [mm (in.)]	Tightening torque [N·m (kgf·cm)]
6.35 (1/4) dia.	16 to 18 (160 to 180)
9.52 (3/8) dia.	32 to 42 (320 to 420)
12.70 (1/2) dia.	49 to 61 (490 to 610)
15.88 (5/8) dia.	63 to 75 (630 to 750)
19.05 (3/4) dia.	90 to 110 (900 to 1,100)

### 3. 7. Fresh air intake

#### ■ Processing before use

- (1) When taking in fresh air, cut out the slit of the cabinet on the left side of the outer case with nippers.

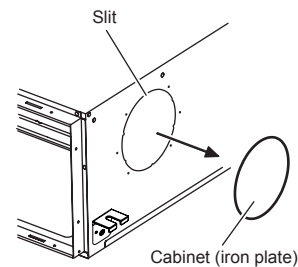

#### ⚠ CAUTION

- When removing the cabinet (iron plate), be careful not to damage the indoor unit internal parts and surrounding area (outer case).
- When processing the cabinet (iron plate), be careful not to injure yourself with burrs, etc.
- When using the Fresh air intake, set the Room temperature sensor switching (Aux.) to "Wired Remote Controller" (01), or to use the Remote sensor.

- (2) Install the round flange to the fresh air intake.

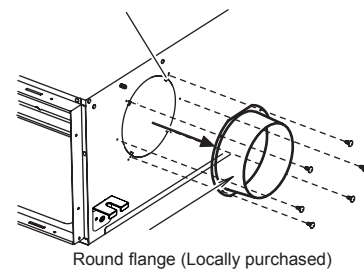

- (3) Connect the duct to the round flange.
- (4) Seal with a band and vinyl tape, etc. so that air does not leak from the connection.

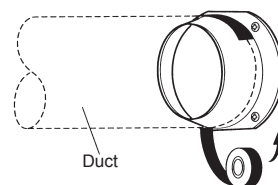

### 3. 8. Electrical wiring

#### ⚠ WARNING

- Electrical work must be performed in accordance with this Manual by a person certified under the national or regional regulations. Be sure to use a dedicated circuit for the unit.  
An insufficient power supply circuit or improperly performed electrical work can cause serious accidents such as electric shock or fire.
- Before starting work, check that power is not being supplied to the indoor unit and outdoor unit.
- Use the included connection cables and power cables or ones specified by the manufacturer. Improper connections, insufficient insulation, or exceeding the allowable current can cause electric shock or fire.
- For wiring, use the prescribed type of cables, connect them securely, making sure that there are no external forces of the cables applied to the terminal connections. Improperly connected or secured cables can cause serious accidents such as overheating the terminals, electric shock, or fire.
- Do not modify the power cables, use extension cables, or use any branches in the wiring. Improper connections, insufficient insulation, or exceeding the allowable current can cause electric shock or fire.
- Match the terminal board numbers and connection cable colors with those of the outdoor unit. Erroneous wiring may cause burning of the electric parts.
- Securely connect the connection cables to the terminal board. In addition, secure the cables with wiring holders. Improper connections, either in the wiring or at the ends of the wiring, can cause a malfunction, electric shock, or fire.
- Always fasten the outside covering of the connection cable with the cable clamp. (If the insulator is chafed, electric leakage may occur.)
- Securely install the electrical box cover on the unit. An improperly installed electrical box cover can cause serious accidents such as electric shock or fire through exposure to dust or water.
- Install sleeves into any holes made in the walls for wiring. Otherwise, a short circuit could result.
- Install a ground leakage breaker. In addition, install the ground leakage breaker so that the entire AC main power supply is cut off at the same time. Otherwise, electric shock or fire could result.
- Always connect the earth (ground) cable.
- Improper earthing (grounding) work can cause electric shocks.
- Install the remote control cables so as not to be touched directly with your hand.
- Perform wiring work in accordance with standards so that the air conditioner can be operated safely and positively.
- Connect the connection cable firmly to the terminal board. Imperfect installation may cause a fire.

#### ⚠ CAUTION

- Ground the unit.  
Do not connect the earth (ground) cable to a gas pipe, water pipe, lightning rod, or a telephone earth (ground) cable.  
Improper earthing (grounding) may cause electric shocks.
- Do not connect power supply cables to the transmission or remote control terminals, as this will damage the product.
- Never bundle the power supply cable and transmission cable together. Bundling these cables together will cause miss operation.
- When handling PCB, static electricity charged in the body may cause malfunction of the PCB. Follow the cautions below:
  - Establish a ground for the indoor and outdoor units and peripheral devices.
  - Cut power (breaker) off.
  - Touch metal part of the indoor and outdoor units for more than 10 seconds to discharge static electricity charged in the body.
  - Do not touch terminals of parts and patterns implemented on PCB.

#### 3. 8. 1. Wiring system diagram

##### ■ Connection cable (to outdoor unit)

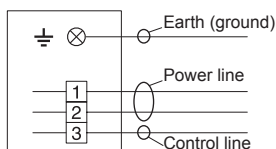

##### ■ Wired remote controller cable

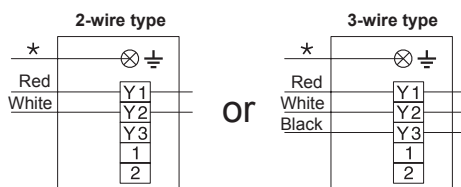

#### 3. 8. 2. Connection cable preparation

##### ■ Connection cable

Keep the earth (ground) wire longer than the other wires.

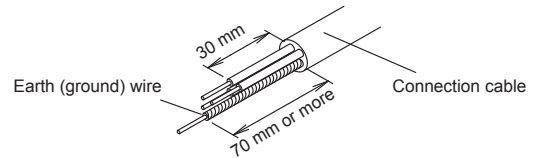

- Use a 4-core wire cable.

##### ■ Remote controller cable

###### For 2-wire type

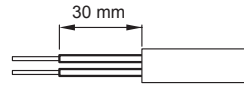

###### For 3-wire type

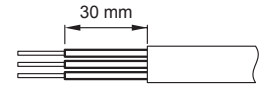

#### 3. 8. 3. How to connect wiring to the terminals.

- (1) Use ring terminals with insulating sleeves as shown in the figure below to connect to the terminal block.
- (2) Securely crimp the ring terminals to the wires using an appropriate tool so that the wires do not come loose.

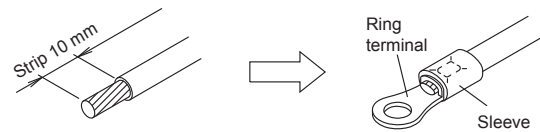

- (3) Use the specified wires, connect them securely, and fasten them so that there is no stress placed on the terminals.
- (4) Use an appropriate screwdriver to tighten the terminal screws.  
Do not use a screwdriver that is too small, otherwise, the screw heads may be damaged and prevent the screws from being properly tightened.
- (5) Do not tighten the terminal screws too much, otherwise, the screws may break.
- (6) See the table below for the terminal screw tightening torques.

#### ⚠ WARNING

Use ring terminals and tighten the terminal screws to the specified torques, otherwise, abnormal overheating may be produced and possibly cause serious damage inside the unit.

Tightening torque [N·m (kgf·cm)]	
M4 screw	1.2 to 1.8 (12 to 18)
M5 screw	2.0 to 3.0 (20 to 30)

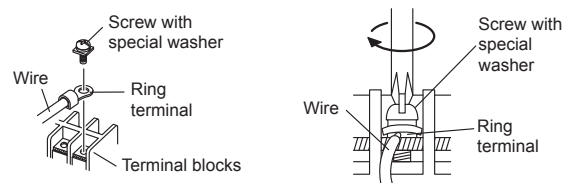

#### 3. 8. 4. Connection wiring

#### ⚠ CAUTION

- Be careful not to mistake the power supply cable and connection wires when installing.
- Install so that the wires for the remote controller will not come in contact with other connection wires.

- (1) Remove the control box cover and install each connection wire.

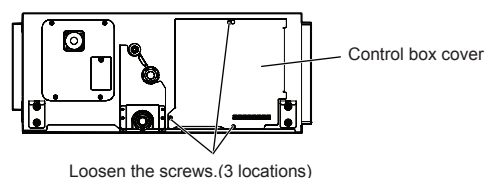

### ■ Connection cable

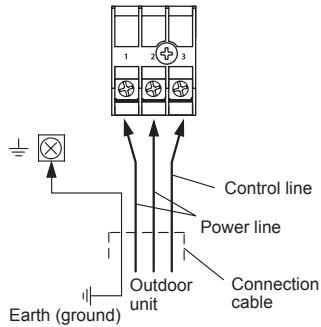

### ■ Remote controller cable

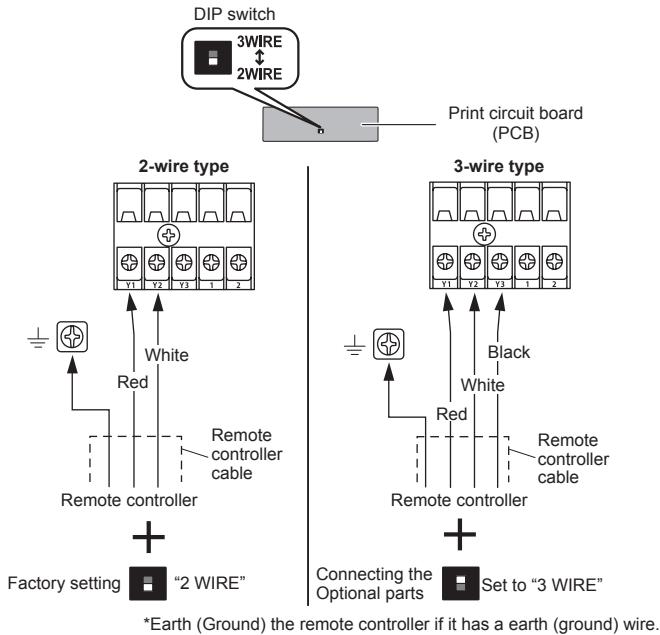

- (2) After wiring is complete, secure the remote controller cable, connection cable, and power supply cable with the cable clamps.

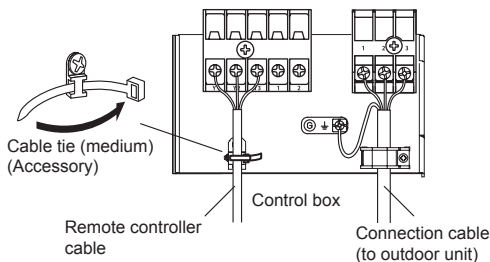

- (3) Seal the cable outlet or other gaps with putty to prevent dew condensation or insect from entering the electric control box.  
 (4) Replace the control box cover.

### ⚠ CAUTION

Do not bundle the remote controller cable, or wire the remote controller cable in parallel, with the indoor unit connection wire (to the outdoor unit) and the power supply cable. It may cause erroneous operation.

### 3.9. Remote controller installation

To install and set the remote controller, refer to the installation manual of the remote controller (wired type).

## 4. OPTIONAL INSTALLATION WORK

### 4.1. Optional kit installation

#### ⚠ WARNING

Regulation of cable differs from each locality, refer in accordance with local rules.

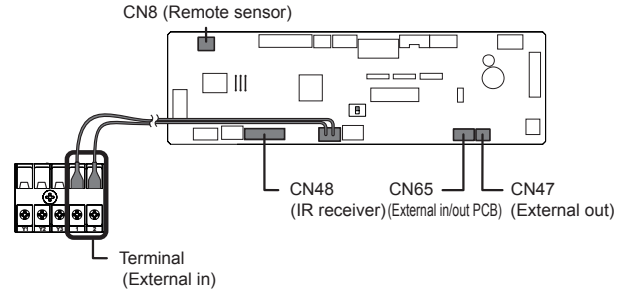

This air conditioner can be connected with the following optional kits. For details on how to install optional parts, refer to the installation manual included in each item.

Connector No.	Option type
CN48	IR Receiver (UTY-LBT*M)
CN8	Remote sensor (UTY-XSZX)
CN47*1	Connect wire (UTY-XWZXZG)
CN65*2	External input and output PCB (UTY-XCSX)

\*1: For external output terminal setting, refer to Function No.60 in "6. FUNCTION SETTING".  
 \*2: Other options (WLAN adapter, converters, etc.) may be available by using the optional External input and output PCB.

### 4.2. External input and output

#### 4.2.1. External input

- Indoor unit functions such as Operation/Stop or Forced stop can be done by using indoor unit terminals.
- "Operation/Stop" mode or "Forced stop" mode can be selected with function setting of indoor unit.
- A twisted pair cable (22 AWG) should be used. Maximum length of cable is 150 m (492 ft.).
- Use an external input and output cable with appropriate external dimension, depending on the number of cables to be installed.
- The wire connection should be separate from the power cable line.

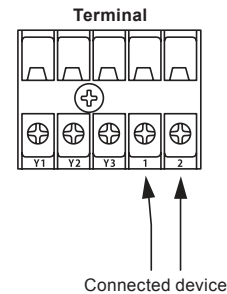

#### ● Dry contact terminal

When a power supply is unnecessary at the input device you want to connect, use the Dry contact terminal.

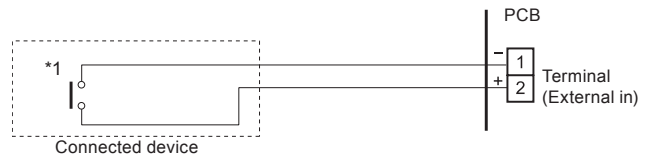

\*1: The switch can be used on the following condition: DC 12 V to 24 V, 1 mA to 15 mA.

#### ■ Operation behavior

##### ● Input signal type



When function setting is "Operation/Stop" mode 1.

Input signal	Command
OFF → ON	Operation
ON → OFF	Stop

**When function setting is "Forced stop" mode.**

Input signal	Command
OFF → ON	Forced stop
ON → OFF	Normal

\* When the forced stop is triggered, indoor unit stops and Operation/Stop operation by a remote controller is restricted.

**When function setting is "Operation/Stop" mode 2.**

Input signal	Command
OFF → ON	Operation
ON → OFF	Stop (R.C. disabled)

**4. 2. 2. External output**

- A twisted pair cable (22AWG) should be used. Maximum length of cable is 25 m (82 ft.).
- Use an external input and output cable with appropriate external dimension, depending on the number of cables to be installed.
- Output voltage: Hi DC12V±2V, Lo 0V.
- Permissible current: 50mA

**■ Output select**

**• When interlocking with external device**

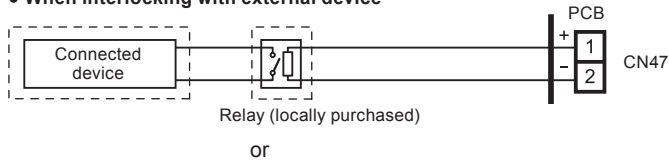

OR

**• When displaying "Operation/Stop"**

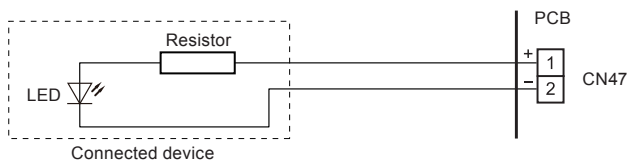

**■ Operation behavior**

\*If function setting "60" is set to "00"

Function setting	Status	Output voltage	
60	00	Stop	0V
		Operation	DC 12 V
	09	Normal	0V
		Error	DC 12 V
	10	Indoor unit fan stop	0V
		Indoor unit fan operation	DC 12 V
11	External heater OFF	0 V	
	External heater ON	DC 12V	

**4. 2. 3. Connection methods**

**■ Wire modification**

- Remove insulation from wire attached to wire kit connector.
- Remove insulation from locally purchased cable. Use crimp type insulated butt connector to join field cable and wire kit wire.
- Connect the wire with connecting wire with solder.

**IMPORTANT:** Be sure to insulate the connection between the wires.

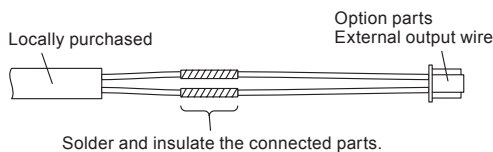

- Connecting wires to the terminals.  
Use ring terminals with insulating sleeves to connect to the terminal block.
- Connection terminals and wiring arrangement

In following figure, all the possible connections are done for description.  
In actual installation, connections will differ according to each installation requirements.

**4. 3. Remote sensor**

**Remote sensor**

- Remove the existing connector and replace it with the remote sensor connector (ensure that the correct connector is used).
- The original connector should be insulated to ensure that it does not come into contact with other electrical circuitry.

**Setting for room temperature correction**

When a remote sensor is connected, set the function setting of indoor unit as indicated below.

- Set Function Number "30" (Room temperature control for cooling) to "00"
- Set Function Number "31" (Room temperature control for heating) to "01"

**5. REMOTE CONTROL INSTALLATION**

**⚠ CAUTION**

- Be sure to turn off the electrical breaker before making settings.
- When setting DIP switches, do not touch any other parts on the circuit board directly with your bare hands.

**5. 1. Group control**

**⚠ CAUTION**

Group control is only possible between units with remote controllers of the same type. To confirm the type of remote controller, see the back of the remote controller or "2. 5. Optional parts".

A number of indoor units can be operated at the same time using a single remote controller.

- (1) Connect up to 16 indoor units in a system. (indoor unit to remote controller)

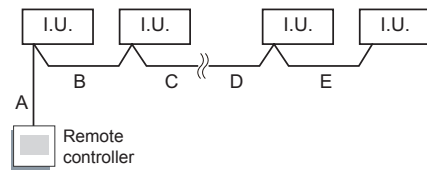

A, B, C, D, E : Remote controller cable. (Refer to "2. 4. Electrical requirement")  
A+B+C+D+E ≤ 500 m.

Example of wiring method (2-wire type)

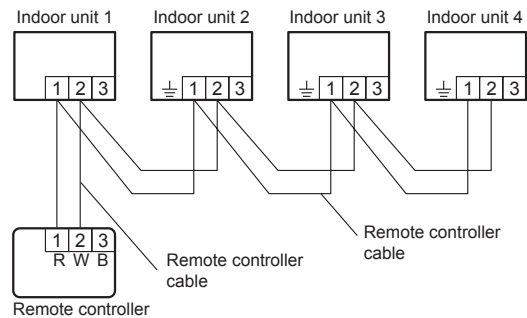

- (2) Set the R.C. address (DIP switch setting)  
Set the R.C. address of each indoor unit using the DIP switch on the indoor unit circuit board.

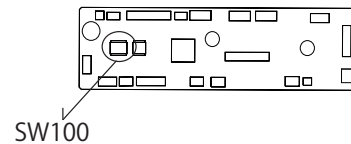

- (a) 2-wire type  
DIP switch (RC AD SW)...Factory setting "00"  
Since the remote controller address settings are automatically configured, you do not need to configure them.  
If configuring manually, it is necessary to configure both the indoor unit and the remote controller. For details, please refer to the remote controller installation manual.
- (b) 3-wire type  
DIP switch (RC AD SW)...Factory setting "00"  
When connecting multiple indoor units to 1 standard wired remote controller, set the address at RC AD SW in sequence from "00".

Setting	Setting range	Switch 100
Remote controller address	00 to 15	Setting example 00  RC AD

**Example** If 4 indoor units are connected.

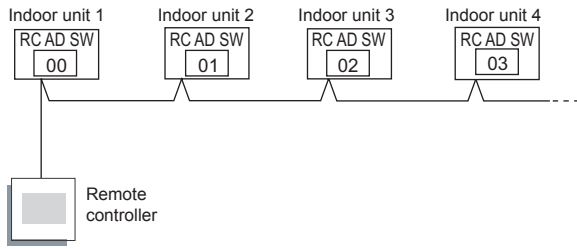

Set the R.C. address in accordance with the table below.

Indoor unit	R.C. address	DIP SWITCH No.			
		1	2	3	4
1	00	OFF	OFF	OFF	OFF
2	01	ON	OFF	OFF	OFF
3	02	OFF	ON	OFF	OFF
4	03	ON	ON	OFF	OFF
5	04	OFF	OFF	ON	OFF
6	05	ON	OFF	ON	OFF
7	06	OFF	ON	ON	OFF
8	07	ON	ON	ON	OFF
9	08	OFF	OFF	OFF	ON
10	09	ON	OFF	OFF	ON
11	10	OFF	ON	OFF	ON
12	11	ON	ON	OFF	ON
13	12	OFF	OFF	ON	ON
14	13	ON	OFF	ON	ON
15	14	OFF	ON	ON	ON
16	15	ON	ON	ON	ON

**NOTE:**

Be sure to set consecutive R.C. address.  
The indoor units cannot be operated if a number is skipped.

**5. 2. Multiple remote control**

Up to 2 remote controllers can be used to operate one indoor unit



Multiple installation method described above is prohibited to combine 3 Wired type with 2 Wired Type.

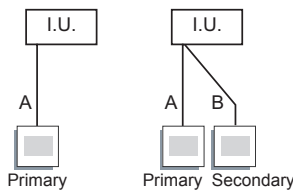

A, B : Remote controller cable. (Refer to "2. 4. Electrical requirement")  
A ≤ 500 m, A+B ≤ 500 m

**5. 3. DIP switch 101 setting**

**Fan delay setting**

This setting can be used when the auxiliary heater is mounted.  
When the operation is stopped when the indoor unit is operating with an auxiliary heater, the operation continues 1 minutes.

**Drainage function setting**

If contained drain pump is not used, set the drainage function to "Disable" in the drainage function switching.

Change the following settings by using the DIP switch.

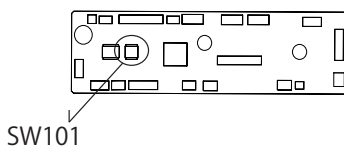

(♦... Factory setting)

DIP switch 101	DIP SW state		Details
	ON	OFF	
1	Disable	Enable ♦	Drainage function setting
2	-	-	Cannot be used (Do not Change)
3	Enable	Disable ♦	Fan delay setting

**6. FUNCTION SETTING**

To change the function settings, refer to the procedures described in the installation manual of the remote controller (wired type).  
The function settings are as follows.

**6. 1. Function details**

**Filter sign**

Select appropriate intervals for displaying the filter sign on the indoor unit according to the estimated amount of dust in the air of the room.

If the indication is not required, select "No indication" (03).

(♦... Factory setting)

Function Number	Setting Value	Setting Description
11	00	Standard (2500 hours)
	01	Long interval (4400 hours)
	02	Short interval (1250 hours)
	03	No indication ♦

**Room temperature control for indoor unit sensor**

Depending on the installed environment, correction of the room temperature sensor may be required.

Select the appropriate control setting according to the installed environment.

The temperature correction values show the difference from the Standard setting "00" (manufacturer's recommended value).

(♦... Factory setting)

Function Number	Setting Value	Setting Description
30 (For cooling)	00	Standard setting ♦
	01	No correction 0.0 °C (0 °F)
	02	-0.5 °C (-1 °F)
	03	-1.0 °C (-2 °F)
	04	-1.5 °C (-3 °F)
	05	-2.0 °C (-4 °F)
	06	-2.5 °C (-5 °F)
	07	-3.0 °C (-6 °F)
	08	-3.5 °C (-7 °F)
	09	-4.0 °C (-8 °F)
	10	+0.5 °C (+1 °F)
	11	+1.0 °C (+2 °F)
	12	+1.5 °C (+3 °F)
	13	+2.0 °C (+4 °F)
	14	+2.5 °C (+5 °F)
	15	+3.0 °C (+6 °F)
	16	+3.5 °C (+7 °F)
17	+4.0 °C (+8 °F)	

**Room temperature control for wired remote controller sensor**

Depending on the installed environment, correction of the wire remote temperature sensor may be required.

Select the appropriate control setting according to the installed environment.

To change this setting, set Function 42 to Both "01".

Ensure that the Thermo Sensor icon is displayed on the remote controller screen.

(♦... Factory setting)

Function number	Setting value	Setting description
35 (For cooling)	00	No correction ♦
	01	No correction 0.0 °C (0 °F)
	02	-0.5 °C (-1 °F)
	03	-1.0 °C (-2 °F)
	04	-1.5 °C (-3 °F)
	05	-2.0 °C (-4 °F)
	06	-2.5 °C (-5 °F)
	07	-3.0 °C (-6 °F)
	08	-3.5 °C (-7 °F)
	09	-4.0 °C (-8 °F)
	10	+0.5 °C (+1 °F)
	11	+1.0 °C (+2 °F)
	12	+1.5 °C (+3 °F)
	13	+2.0 °C (+4 °F)
	14	+2.5 °C (+5 °F)
	15	+3.0 °C (+6 °F)
	16	+3.5 °C (+7 °F)
17	+4.0 °C (+8 °F)	



### ■ Auto restart

Enable or disable automatic restart after a power interruption.

(◆... Factory setting)

Function Number	Setting Value	Setting Description
40	00	Enable
	01	Disable

\* Auto restart is an emergency function such as for power outage etc. Do not attempt to use this function in normal operation. Be sure to operate the unit by remote controller or external device.

### ■ Room temperature sensor switching

(Only for wireless remote controller)

When using the Wired remote controller temperature sensor, change the setting to "Both" (01).

(◆... Factory setting)

Function Number	Setting Value	Setting Description
42	00	Indoor unit
	01	Both

00: Sensor on the indoor unit is active.

01: Sensors on both indoor unit and wired remote controller are active.

\* Remote controller sensor must be turned on by using the remote controller

### ■ Cold air prevention

\*This setting is to disable the cold air prevention function during heating operation. When disabled, the fan setting will always follow the setting on the remote controller. (Excluding defrost mode).

(◆... Factory setting)

Function Number	Setting Value	Setting Description
43	00	Enable
	01	Disable

### ■ External input control

"Operation/Stop" mode or "Forced stop" mode can be selected.

(◆... Factory setting)

Function Number	Setting Value	Setting Description
46	00	Operation/Stop mode 1
	01	(Setting prohibited)
	02	Forced stop mode
	03	Operation/Stop mode 2

### ■ Room temperature sensor switching (Aux.)

To use the temperature sensor on the wired remote controller only, change the setting to "Wired remote controller" (01). This function will only work if the function setting 42 is set at "Both" (01)

(◆... Factory setting)

Function Number	Setting Value	Setting Description
48	00	Both
	01	Wired remote controller

### ■ Indoor unit fan control for energy saving for cooling

Enables or disables the power-saving function by controlling the indoor unit fan rotation when the outdoor unit is stopped during cooling operation.

(◆... Factory setting)

Function Number	Setting Value	Setting description
49	00	Disable
	01	Enable
	02	Remote controller

00: When the outdoor unit is stopped, the indoor unit fan operates continuously following the setting on the remote controller.

01: When the outdoor unit is stopped, the indoor unit fan operates intermittently at a very low speed.

02: Enable or disable this function by remote controller setting.

\*When using a wired remote controller without Indoor unit fan control for energy saving for cooling function, or when connecting a single split converter, the setting cannot be made by using the remote controller. Set to "00" or "01".

To confirm if the remote controller has this function, refer to the operating manual of each remote controller.

### ■ Switching functions for external output terminal

Functions of the external output terminal can be switched.

(◆... Factory setting)

Function Number	Setting Value	Setting Description
60	00	Operation status
	01 to 08	(Setting prohibited)
	09	Error status
	10	Fresh air control
	11	Auxiliary heater

### ■ Setting record

Record any changes to the settings in the following table.

Function setting	Setting Value
Filter sign	
Static pressure	
Room temperature control for indoor unit sensor	cooling
	heating
Room temperature control for wired remote controller sensor	cooling
	heating
Auto restart	
Room temperature sensor switching	
Cold air prevention	
External input control	
Room temperature sensor switching (Aux.)	
Indoor unit fan control for energy saving for cooling	
Switching functions for external output terminal	

After completing the Function Setting, be sure to turn off the power and turn it on again.

## 6. 2. Static pressure

The static pressure can be set by the following 2 methods. Choose accordingly.

### a. Manual setting (Function setting)

Select the appropriate static pressure according to the installation conditions.

(◆... Factory setting)

Function Number	Setting Value	Setting Description
26	03	30 Pa
	04	40 Pa
	05	50 Pa
	06	60 Pa
	07	70 Pa
	08	80 Pa
	09	90 Pa
	10	100 Pa
	11	110 Pa
	12	120 Pa
	13	130 Pa
	14	140 Pa
	15	150 Pa
	16	160 Pa
	17	170 Pa
	18	180 Pa
	19	190 Pa
	20	200 Pa
	31	Standard (35 Pa: 12/14/18/22/24 model) (47 Pa: 30/36 model) (60 Pa: 45/54 model)
	32	Automatic airflow adjustment

\* The range of static pressure is different by model.

For details, see the Fan performance curve of the technical data.

Model name	Range of static pressure
12/14/18/22/24/30/36 model	30 to 200 Pa
45/54 model	30 to 160 Pa

Record the setting value of Function 26 in the Setting record table in "6. 1. Function details".

## b. Automatic airflow adjustment

### ⚠ CAUTION

- This function cannot be used when there is a booster fan between the ducts.
- Be sure that the static pressure is within the allowed range. Incorrect setting may cause incorrect adjustment and may result in insufficient airflow or water leakage.
- When the external static pressure is changeable in the installation by use of automatic changeable dampers, etc., set so that the external static pressure is the lowest.

#### NOTE:

Be sure to conduct this setting before any other operation. If the motor is warm or the heat exchanger is wet, false detection may lead to incorrect adjustments. Check if the electrical wirings and duct installations are complete. If there is a damper installed in the system, make sure the damper is open. Check if the air filter (optional) is attached. If there are several inlet, outlet ports, make sure the airflow rates of each port match the designed airflow rate by adjusting the throttles.

Automatic airflow adjustment is possible by the following procedures.

- 1) Change the setting of Function 26 to "Automatic airflow adjustment" (32).
- 2) Run the air conditioner on Fan mode (High).
  - \* For instructions on how to operate the air conditioner, refer to the operation manual of the remote controller.
  - During Automatic airflow adjustment, the mode will be fixed at Fan mode (High). When this function is active, do not operate the Outdoor unit.
- 3) The air conditioner will run for about 1 to 8 min. then stop automatically.
  - \* Do not change the throttles of the inlet and outlet ports during operation. When used in a Group control system, the setting will take about 10 min.
- 4) Turn the air conditioner off and on again.
- 5) Check the setting value of Function 26 and record the obtained setting value in the following table.
  - \* If the setting value has not changed, repeat the procedure from step 1.

Function Number	Setting value
26	

### ⚠ CAUTION

- If the detected setting value is not within the range of static pressure, please check and re-arrange the installation, then repeat the procedure from step 1. Incorrect setting may result in insufficient airflow or water leakage.
- When the duct or outlet installations are changed after the Automatic airflow adjustment is completed, repeat the procedure from step 1.

## 7. CHECK LIST

Pay special attention to the check items below when installing the indoor unit(s). After installation is complete, be sure to check the following check items again.

Check items	Check box
Has the indoor unit been installed correctly?	
Has there been a check for gas leaks (refrigerant pipes)?	
Has heat insulation work been completed?	
Does water drain easily from the indoor units?	
Is the voltage of the power source the same as that indicated on the label on the indoor unit?	
Are the wires and pipes all connected completely?	
Is the indoor unit grounded?	
Is the connection cable the specified thickness?	
Are the inlets and outlets free of any obstacles?	
After installation is completed, has the proper operation and handling been explained to the user?	
Operate the unit according to the operating manual provided, and check that it is operating normally.	

## 8. TEST RUN

### 8.1. Check items

- Is operation of each button on the remote control unit normal?
- Does each lamp light normally?
- Is the drain normal?
- Do not have an abnormal noise and vibration during operation?

Do not operate the air conditioner in test run for a long time.

## 8.2. Operation method

Depending on your installation, choose from the following:

### ■ By the wireless remote controller (with [TEST RUN] button)

- To start test run, press the [START/STOP] button and the [TEST RUN] button on the remote controller.
- To end test run, press the remote controller [START/STOP] button.

### ■ By the indoor unit or IR receiver unit

- To start test run, press the [MANUAL AUTO] button of the unit for more than 10 seconds (forced cooling).
- To end test run, press the [MANUAL AUTO] button for more than 3 seconds or press the remote controller [START/STOP] button.
- The Operation indicator lamp and Timer indicator lamp will simultaneously flash during the test run mode.

### ■ By the wired remote controller

- For the operation method, refer to the installation manual and the operating manual of the wired remote controller.

Heating test run will begin in a few minutes when HEAT is selected by the remote controller [reverse cycle model only].

## 9. FINISHING

Install the heat insulation material after performing a refrigerant leak check (see the installation manual for the outdoor unit for details).

### Coupler heat insulation

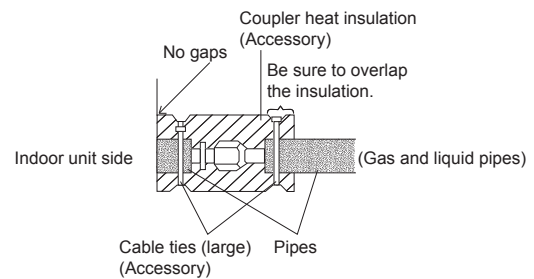

### ⚠ CAUTION

There should be no gaps between the insulation and the product.

### ⚠ CAUTION

- After connecting the piping, check the all joints for gas leakage with gas leak detector.
- Once the pressure checking has been completed using nitrogen, please refer to the outdoor unit installation manual to complete the evacuation process.
- Install heat insulation around both the large (gas) and small (liquid) pipes. Failure to do so may cause water leaks.

## 10. CUSTOMER GUIDANCE

Explain the following to the customer in accordance with the operating manual:

- (1) Starting and stopping method, operation switching, temperature adjustment, timer, air flow switching, and other remote controller operations.
- (2) Cleaning and maintenance of the product, and other items such as air filters and air louvers if applicable.
- (3) Give the operating and installation manuals to the customer.
- (4) If the indoor unit custom code is changed, and the installation includes a wireless remote controller, inform the customer the changed code. (On some wireless remote controllers, the custom code may return to A when batteries are replaced.)

## 11. ERROR CODES

If you use a wired type remote controller, error codes will appear on the remote controller display. If you use a wireless remote controller, the lamps on the IR receiver unit will output error codes by way of blinking patterns. See the lamp blinking patterns and error codes in the table below. An error display is displayed only during operation. For more details, refer to the installation manual of the remote controller.

Error display			Wired remote controller Error code	Description
OPERATION lamp (green)	TIMER lamp (orange)	ECONOMY lamp (green)		
●(1)	●(1)	◇	11	Serial communication error
●(1)	●(2)	◇	12	Wired remote controller communication error
●(1)	●(5)	◇	15	Check run unfinished Automatic airflow adjustment error
●(1)	●(6)	◇	16	Peripheral unit transmission PCB connection error
●(1)	●(8)	◇	18	External communication error
●(2)	●(1)	◇	21	Unit number or Refrigerant circuit address setting error [Simultaneous Multi]
●(2)	●(2)	◇	22	Indoor unit capacity error
●(2)	●(3)	◇	23	Combination error
●(2)	●(4)	◇	24	• Connection unit number error (indoor secondary unit) [Simultaneous Multi] • Connection unit number error (indoor unit or branch unit) [Flexible Multi]
●(2)	●(6)	◇	26	Indoor unit address setting error
●(2)	●(7)	◇	27	Primary unit, secondary unit setup error [Simultaneous Multi]
●(2)	●(9)	◇	29	Connection unit number error in wired remote controller system
●(3)	●(1)	◇	31	Power supply interruption error
●(3)	●(2)	◇	32	Indoor unit PCB model information error
●(3)	●(3)	◇	33	Indoor unit motor electricity consumption detection error
●(3)	●(5)	◇	35	Manual auto switch error
●(3)	●(9)	◇	39	Indoor unit power supply error for fan motor
●(3)	●(10)	◇	3A	Indoor unit communication circuit (wired remote controller) error
●(4)	●(1)	◇	41	Room temp. sensor error
●(4)	●(2)	◇	42	Indoor unit heat ex. middle temp. sensor error
●(4)	●(4)	◇	44	Human sensor error
●(5)	●(1)	◇	51	Indoor unit fan motor error
●(5)	●(3)	◇	53	Drain pump error
●(5)	●(7)	◇	57	Damper error
●(5)	●(15)	◇	5U	Indoor unit error
●(6)	●(1)	◇	61	Outdoor unit reverse/missing phase and wiring error

Error display			Wired remote controller Error code	Description
OPERATION lamp (green)	TIMER lamp (orange)	ECONOMY lamp (green)		
●(6)	●(2)	◇	62	Outdoor unit main PCB model information error or communication error
●(6)	●(3)	◇	63	Inverter error
●(6)	●(4)	◇	64	Active filter error, PFC circuit error
●(6)	●(5)	◇	65	Trip terminal L error
●(6)	●(8)	◇	68	Outdoor unit rush current limiting resistor temp. rise error
●(6)	●(10)	◇	6A	Display PCB microcomputers communication error
●(7)	●(1)	◇	71	Discharge temp. sensor error
●(7)	●(2)	◇	72	Compressor temp. sensor error
●(7)	●(3)	◇	73	Outdoor unit Heat Ex. liquid temp. sensor error
●(7)	●(4)	◇	74	Outdoor temp. sensor error
●(7)	●(5)	◇	75	Suction Gas temp. sensor error
●(7)	●(6)	◇	76	• 2-way valve temp. sensor error • 3-way valve temp. sensor error
●(7)	●(7)	◇	77	Heat sink temp. sensor error
●(8)	●(2)	◇	82	• Sub-cool Heat Ex. gas inlet temp. sensor error • Sub-cool Heat Ex. gas outlet temp. sensor error
●(8)	●(3)	◇	83	Liquid pipe temp. sensor error
●(8)	●(4)	◇	84	Current sensor error
●(8)	●(6)	◇	86	• Discharge pressure sensor error • Suction pressure sensor error • High pressure switch error
●(9)	●(4)	◇	94	Trip detection
●(9)	●(5)	◇	95	Compressor rotor position detection error (permanent stop)
●(9)	●(7)	◇	97	Outdoor unit fan motor 1 error
●(9)	●(8)	◇	98	Outdoor unit fan motor 2 error
●(9)	●(9)	◇	99	4-way valve error
●(9)	●(10)	◇	9A	Coil (expansion valve) error
●(10)	●(1)	◇	A1	Discharge temp. error
●(10)	●(3)	◇	A3	Compressor temp. error
●(10)	●(4)	◇	A4	High pressure error
●(10)	●(5)	◇	A5	Low pressure error
●(13)	●(2)	◇	J2	Branch boxes error [Flexible Multi]

Display mode ● : 0.5s ON / 0.5s OFF  
◇ : 0.1s ON / 0.1s OFF  
( ) : Number of flashing