

### ARXG24KHTAP

Please visit our webstore for full product and technical documentation 

Unit Type	Medium Static Ducted
Remote Controller	Option
Nominal Cooling Capacity (kW)	6.8
Nominal Heating Capacity (kW)	7.5
Height (mm)	300
Width (mm)	1000
Depth (mm)	700
Weight (kg)	36
Filter	UTDLFNB
Standard Static Pressure (Pa)	35
Static Pressure Ranget (Pa)	30 to 200
Airflow Rate - Cooling - High (m3/h)	1360
Airflow Rate - Heating - High (m3/h)	1360
Sound Pressure Level - Cooling - High (dB(A))	32
Sound Pressure Level - Cooling - Low (dB(A))	21
Sound Pressure Level - Heating - High (dB(A))	32
Sound Pressure Level - Heating - Low (dB(A))	21
Sound Power Level - Cooling - High (dB(A))	57
Sound Power Level - Heating - High (dB(A))	57
Moisture Removal (l/h)	1.8
Refrigerant Type (Global Warming Potential)	R32 (675)
Liquid Pipe Size	1/4"
Gas Pipe Size	1/2"
Unit Power Supply	From Outdoor Unit

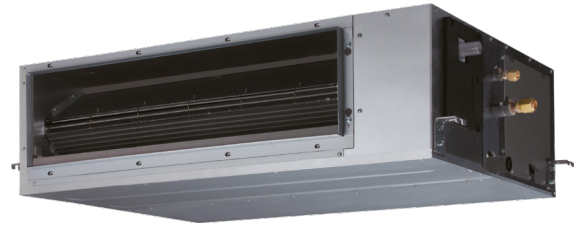

#### Document Downloads

- [Airflow - Fan Curve](#)
- [Controls & Accessories](#)
- [Dimensional Drawing](#)
- [Function Settings](#)
- [Inputs & Outputs](#)
- [Installation Manual](#)
- [Noise Curve](#)
- [Operation Manual](#)
- [Product Image](#)
- [Spare Parts List All Pages](#)
- [Specifications](#)
- [Wiring Diagram](#)

#### Related Items

- [AOYG24KBTB](#)
- [UTYRNRYZ5](#)
- [UTYTF SXZ1](#)
- [UTDLFNB](#)
- [UTYRCRYZ1](#)
- [UTYRVNYM](#)
- [UTYRHRY](#)
- [UTYRSRY](#)
- [UTYRSNYM](#)
- [UTYXCSX](#)
- [UTYXWZXZG](#)
- [UTZGXNA](#)
- [UTYTERX](#)
- [UTYXSZX](#)
- [FJRCWIF1](#)
- [UTYLBTYM](#)
- [UTYVTGX](#)
- [UTYVTGXV](#)
- 6.8kW Standard Outdoor Unit - R32 Single Phase
- Touch Screen Remote Controller
- Wireless LAN interface
- Long Life Filter Kit
- Compact Simple Remote controller
- LCD Wired Remote Controller
- Simple Remote Controller (without Master Control)
- Simple Remote Controller (with Master Control)
- Simplified Wired Remote Controller
- External Input / Output PCB
- External Connect Kit
- External Input / Output PCB Bracket
- External switch controller
- Remote Sensor Unit (for All Duct type)
- IntesisHome Wireless LAN Adapter for Splits & VRF
- Infra-Red Receiver Kit, Receiver Wire -9710358012
- Splits Network Converter (DC Powered)
- Splits Network Converter (AC Powered)

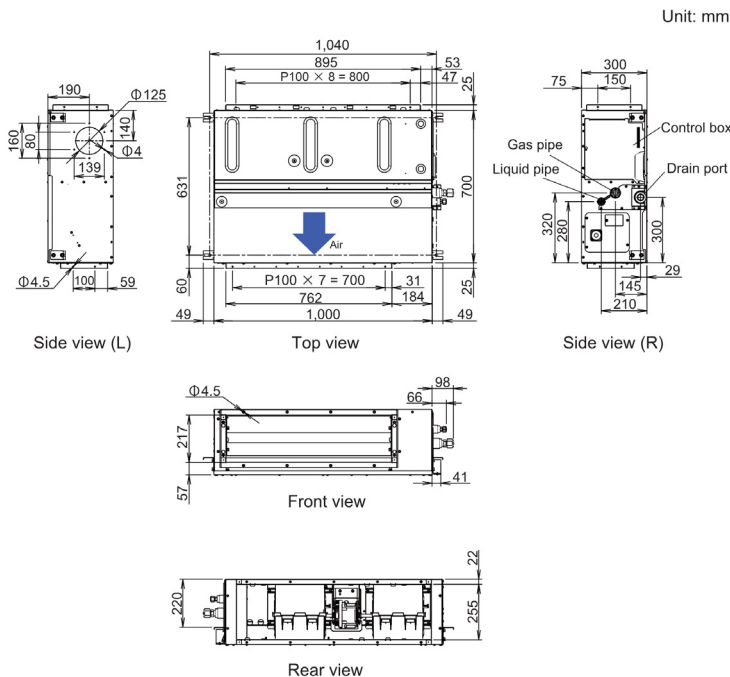

\*Specifications and design are subject to change without notice for further improvement.  
 \*Actual products' colors may be different from the colors shown in this printed material.