

8. External input and output

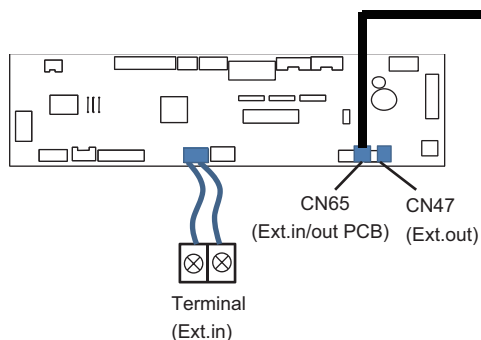

Fig. Indoor unit PCB

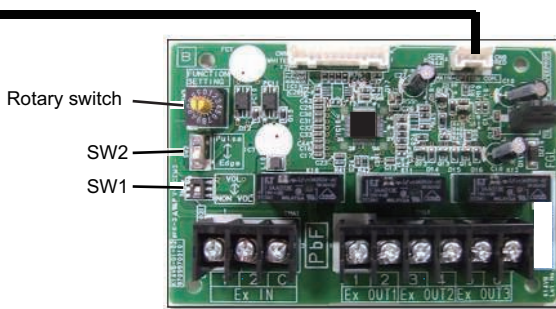

Fig. External input and output PCB

PCB	External input	External output	Connector	Input select	Input signal	External connect kit (Optional parts)
Indoor unit	Operation/Stop Forced stop	—	Terminal	Dry contact	Edge	—
	—	Operation status	CN47	—	—	UTY-XWZXZG
		Error status				
		Indoor unit fan operation status				
External heater output						
External input and output (UTY-XCSX)	Operation/Stop	—	Input 1/ Input 2	Dry contact/ Apply voltage	Edge/ Pulse	—
	Forced thermostat off		Input 1		Edge	
	—	Operation status	Output 1 Output 2 Output 3	—	—	—
		Error status				
Indoor unit status						
External heater output						

8-1. External input

- “Operation/Stop” mode or “Forced stop” mode can be selected with function setting of indoor unit.
- A twisted pair cable (22AWG) should be used. Maximum length of cable is 150 m.
- The wire connection should be separate from the power cable line.

■ Indoor unit

Indoor unit functions such as Operation/Stop can be done by using indoor unit terminals.

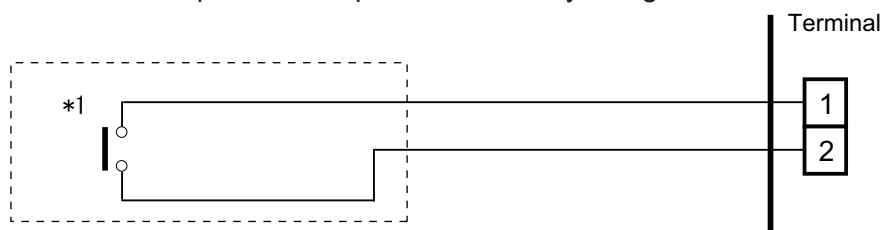

*1: The switch can be used on the following condition: DC 12 V to 24 V, 1 mA to 15 mA.

External input and output PCB

The indoor unit Operation/Stop can be set by using the input terminal on the PCB.

Input select

Use either one of these types of terminals according to the application. (Both types of terminals cannot be used simultaneously.)

- Dry contact

In case of internal power supply, set the slide switch of SW1 to "NON VOL" side.

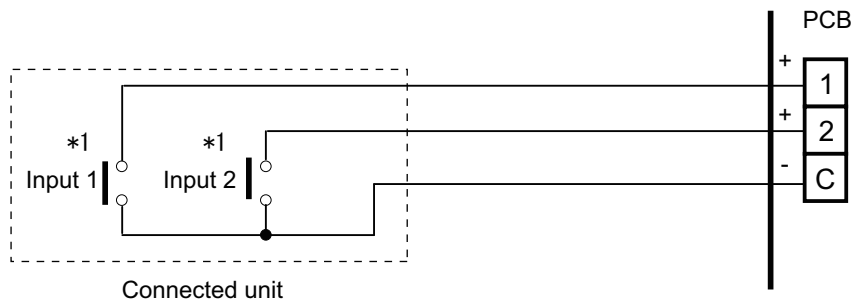

*1: The switches can be used on the following condition: DC 12 V to 24 V, 1 mA to 15 mA.

- Apply voltage

In case of external power supply, set the slide switch of SW1 to "VOL" side.

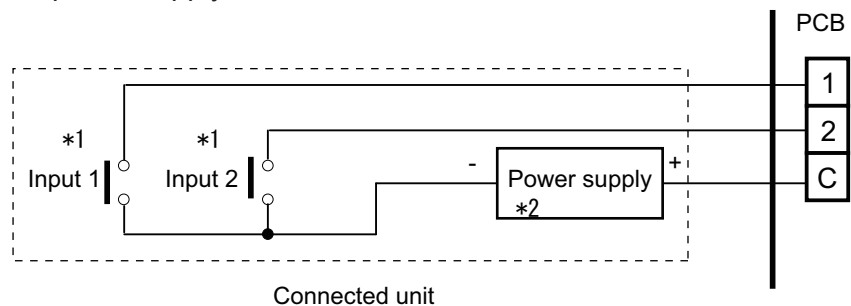

*1: The switches can be used on the following condition: DC 12 V to 24 V, 1 mA to 15 mA.

*2: Make the power supply DC 12 V to 24 V 10 mA or more.

8-2. External output

Use an external output cable with appropriate external dimension, depending on the number of cables to be installed.

Indoor unit

- A twisted pair cable (22AWG) should be used. Maximum length of cable is 25 m.
- Output voltage: High DC 12 V \pm 2 V, Low 0 V.
- Permissible current: 50 mA
- For details, refer to Chapter 8-3. "[Combination of external input and output](#)" on page 38.

When indicator, etc. are connected directly

Example: Function setting 60 is set to "00"

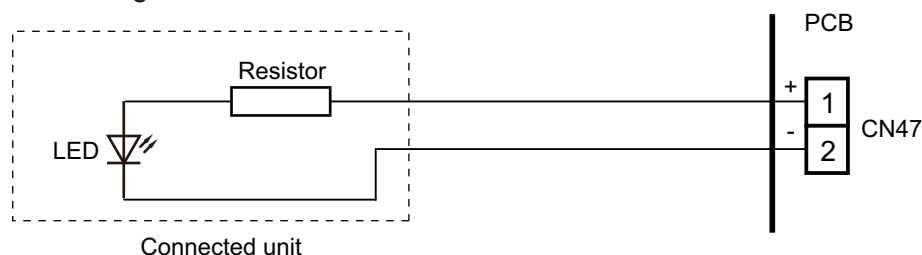

When connecting with a device equipped with a power supply

Example: Function setting 60 is set to "00"

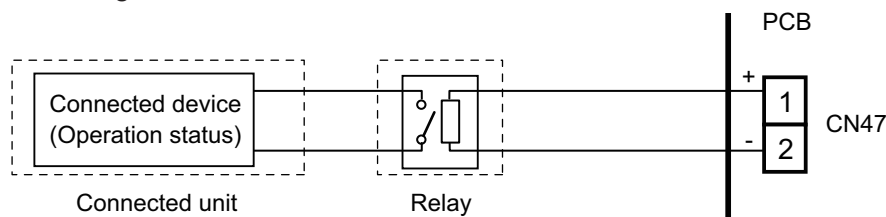

External input and output PCB

- A twisted pair cable (22AWG) should be used.
- Permissible voltage and current: DC 5 V to 30 V / 3 A, AC 30 V to 250 V / 3 A
- For details, refer to Chapter 8-3. "[Combination of external input and output](#)" on page 38.

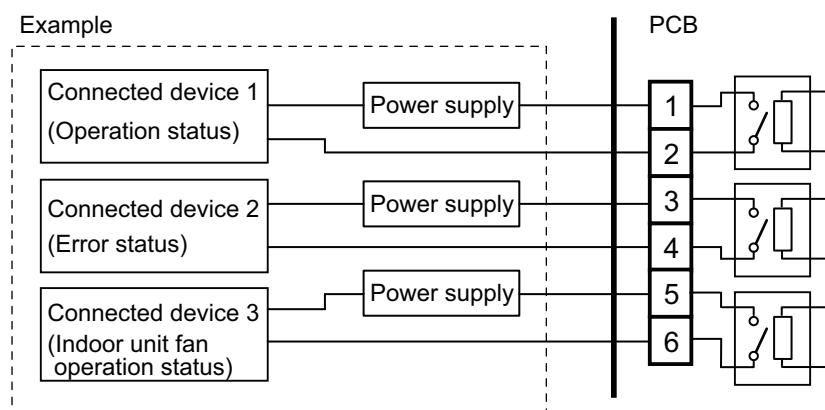

8-3. Combination of external input and output

By combining the function setting of the indoor unit and rotary switch setting of the External input and output PCB, you can select various combinations of functions.

Combination examples of external input and output are as follows:

Mode	Function setting	External input and output PCB (Rotary SW)	External input			
			Indoor unit Input	External input and output PCB		
			Terminal	Input 1	Input 2	Signal type
0-1	60-00	1	Operation/Stop	Operation/Stop	Not available	Edge
				Operation	Stop	Pulse
0-2	60-00	2	Operation/Stop	Forced Thermostat OFF	Not available	Edge
1—8	60-01 to 60-08	3 - 9, A	(Setting prohibited)			
9	60-09	B	Operation/Stop	Forced Thermostat OFF	Not available	Edge
10	60-10	C	Operation/Stop	Forced Thermostat OFF	Not available	Edge
11	60-11	D	Operation/Stop	Forced Thermostat OFF	Not available	Edge

Mode	Function setting	External input and output PCB (Rotary SW)	External output			
			Indoor unit Output	External input and output PCB		
			CN47	Output 1	Output 2	Output 3
0-1	60-00	1	Operation/Stop	Operation/Stop	Error status	Indoor unit fan operation status
0-2	60-00	2	Operation/Stop	Error status	Indoor unit fan operation status	External heater output
1—8	60-01 to 60-08	3 - 9, A	(Setting prohibited)			
9	60-09	B	Error status	Operation/Stop	Indoor unit fan operation status	External heater output
10	60-10	C	Indoor unit fan operation status	Operation/Stop	Error status	External heater output
11	60-11	D	External heater output	Operation/Stop	Indoor unit fan operation status	Error status

NOTE: Input of Operation/Stop depends on the setting of function setting 46.

00: Operation/Stop mode 1 (R.C. enabled)

01: (Setting prohibited)

02: Forced stop

03: Operation/Stop mode 2 (R.C. disabled)

Input signal type

- Indoor unit
Input signal type is only "Edge".

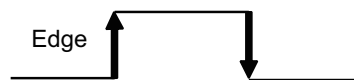

- External input and output PCB
The input signal type can be selected.

Signal type (edge or pulse) can be switched by the DIP switch 2 (SW2) on the External input and output PCB.

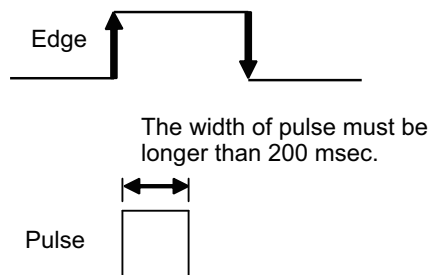

8-4. Details of function

■ Control input function

● When function setting is "Operation/Stop" mode 1

- In the case of "Edge" input

Function setting /	Rotary SW of External input and output PCB	External input		Input signal	Command
46-00	-	Input of indoor unit	Terminal	Off → On	Operation
				On → Off	Stop
	60-00 / 1	External input and output PCB	Input 1	Off → On	Operation
				On → Off	Stop

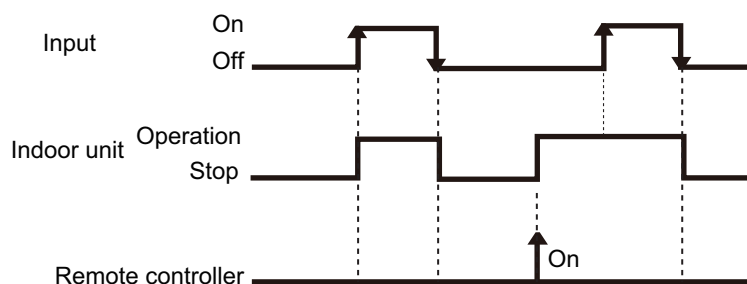

- In the case of "Pulse" input

Function setting /	Rotary SW of External input and output PCB	External input		Input signal	Command
46-00	60-00 / 1	External input and output PCB	Input 1	Pulse	Operation
			Input 2	Pulse	Stop

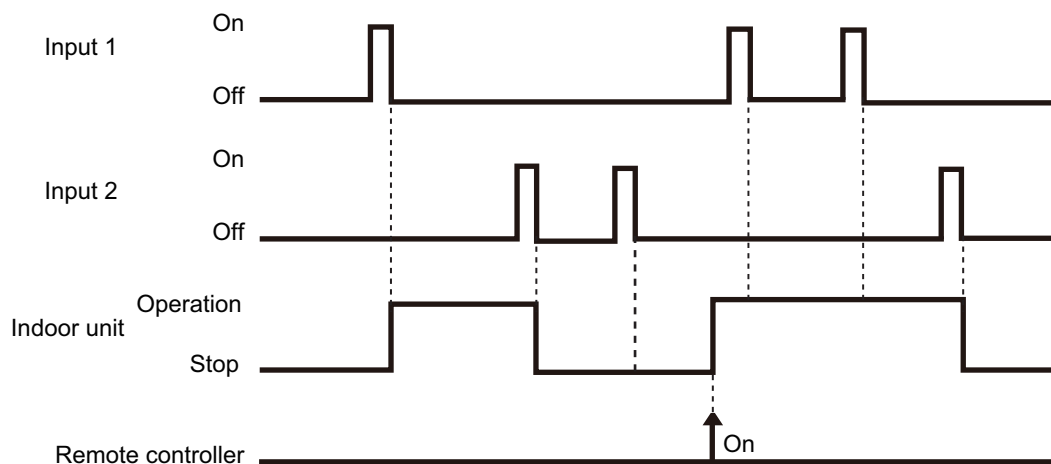

NOTES:

- The last command has priority.
- The indoor units within the same remote controller group operates in the same mode.

● When function setting is "Forced stop" mode

- In the case of "Edge" input

Function setting /	Rotary SW of External input and output PCB	External input		Input signal	Command
46-02	-	Input of indoor unit	Terminal	Off → On	Forced stop
				On → Off	Normal
	60-00 / 1	External input and output PCB	Input 1	Off → On	Forced stop
				On → Off	Normal

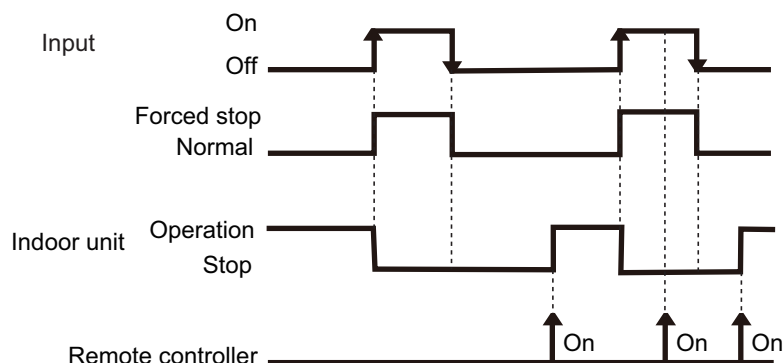

- In the case of "Pulse" input

Function setting /	Rotary SW of External input and output PCB	External input		Input signal	Command
46-02	60-00 / 1	External input and output PCB	Input 1	Pulse	Forced stop
			Input 2	Pulse	Normal

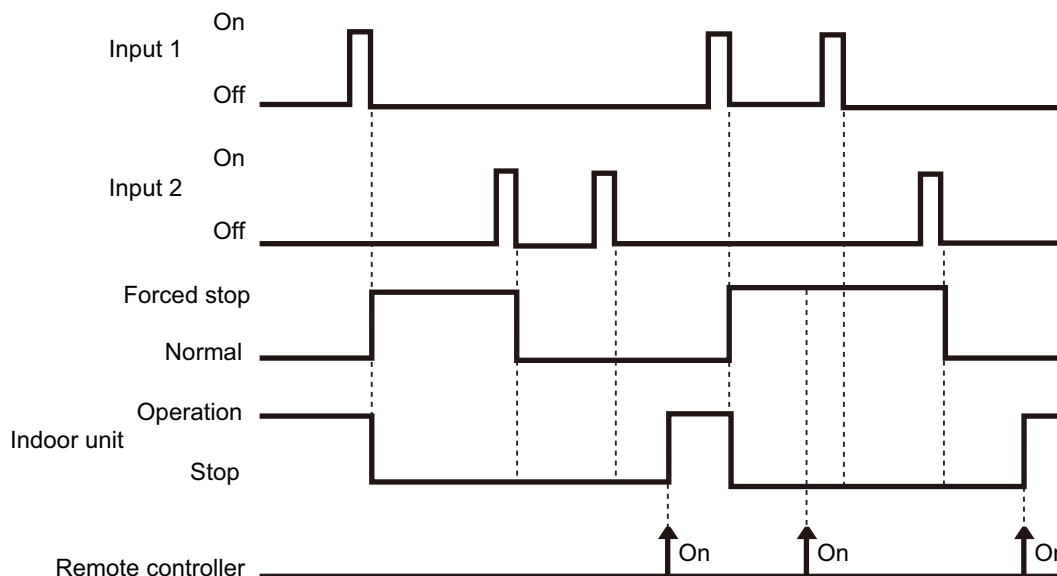

NOTES:

- When the forced stop is triggered, indoor unit stops and Operation/Stop operation by the remote controller is restricted.
- When forced stop function is used with forming a remote controller group, connect the same equipment to each indoor unit within the group.

● When function setting is "Operation/Stop" mode 2

- In the case of "Edge" input

Function setting /	Rotary SW of External input and output PCB	External input		Input signal	Command
46-03	-	Input of indoor unit	Terminal	Off → On	Operation
				On → Off	Stop (R.C. disabled)
	60-00 / 1	External input and output PCB	Input 1	Off → On	Operation
				On → Off	Stop (R.C. disabled)

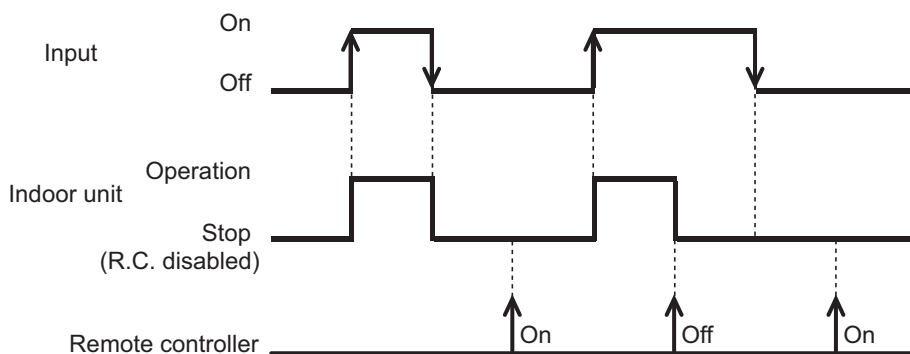

- In the case of "Pulse" input

Function setting /	Rotary SW of External input and output PCB	External input		Input signal	Command
46-03	60-00 / 1	External input and output PCB	Input 1	Pulse	Operation
			Input 2	Pulse	Stop (R.C. disabled)

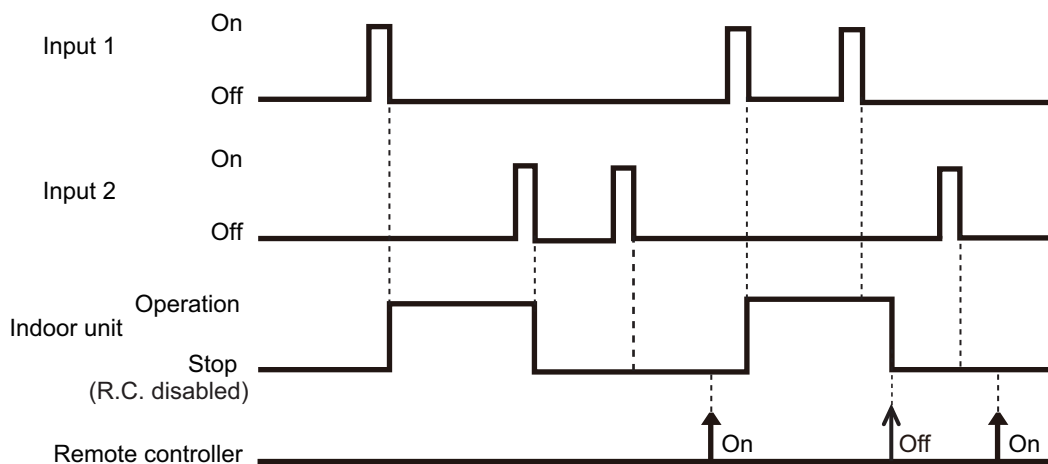

NOTES:

- When "Operation/Stop" mode 2 function is used with forming a remote controller group, connect the same equipment to each indoor unit within the group.

■ Forced thermostat off function

Function setting /	Rotary SW of External input and output PCB	External input		Input signal	Command
60-00 / 2 60-09 / B 60-10 / C 60-11 / D		External input and output PCB	Input 1	Off → On	Thermostat off
				On → Off	Normal operation

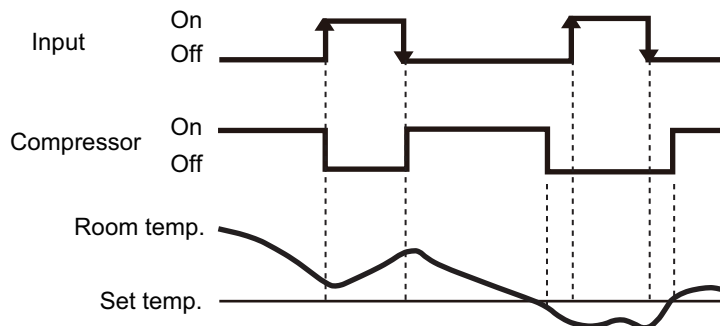

■ Control output function

Function setting /	Rotary SW of External input and output PCB	External output		Output signal	Command
60-00 / 1, 2		Output of indoor unit	CN47	Low → High High → Low	Operation Stop
60-00 / 1 60-09 / B 60-10 / C 60-11 / D		External input and output PCB	Output 1	Off → On	Operation
				On → Off	Stop

The output is low when the unit is stopped.

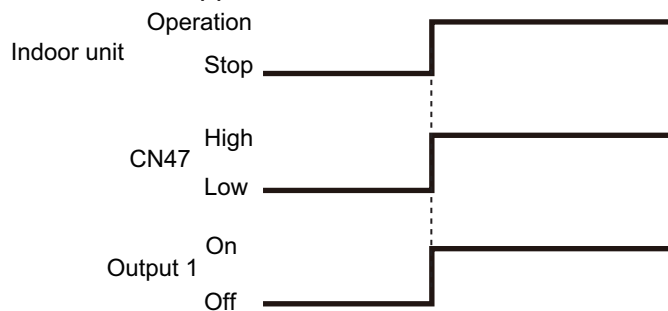

■ Error status

Function setting /	Rotary SW of External input and output PCB	External output		Output signal	Command
60-09 / B		Output of indoor unit	CN47	Low → High	Error
				High → Low	Normal
60-00 / 2		External input and output PCB	Output 1	Off → On	Error
				On → Off	Normal
60-00 / 1 60-10 / C		External input and output PCB	Output 2	Off → On	Error
				On → Off	Normal
60-11 / D		External input and output PCB	Output 3	Off → On	Error
				On → Off	Normal

The output is ON when an error is generated for the indoor unit.

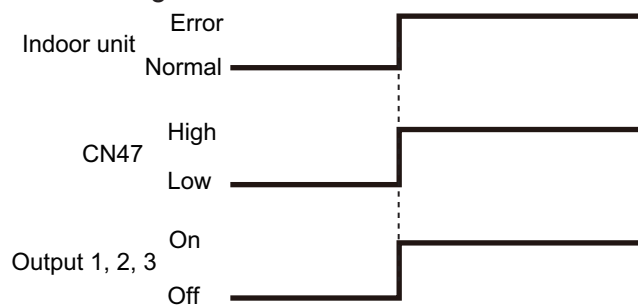

■ Indoor unit fan operation status

Function setting /	Rotary SW of External input and output PCB	External output		Output signal	Command
60-10 / C		Output of indoor unit	CN47	Low → High	Fan run
				High → Low	Fan stop
60-00 / 2 60-09 / B 60-11 / D		External input and output PCB	Output 2	Off → On	Fan run
				On → Off	Fan stop
60-00 / 1		External input and output PCB	Output 3	Off → On	Fan run
				On → Off	Fan stop

Output signal	Condition
On Low → High	The indoor unit fan is operating.
Off High → Low	The fan is stopped or during cold air prevention. During thermostat off when in dry mode operation.

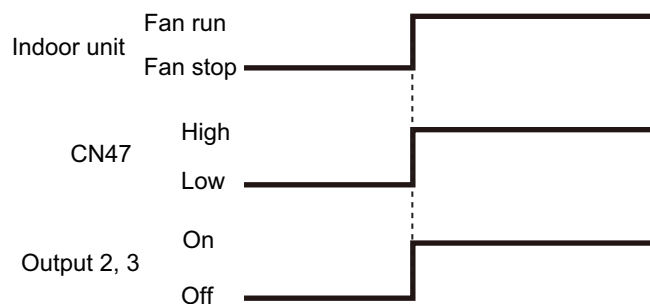

External heater output

Function setting /	Rotary SW of External input and output PCB	External output		Output signal	Command
	60-11 / D	Output of indoor unit	CN47	Low → High	Heater on
				High → Low	Heater off
	60-00 / 2 60-09 / B 60-10 / C	External input and output PCB	Output 3	Off → On	Heater on
				On → Off	Heater off

Output signal	Condition
Low → High Off → On	Heater turns on as shown in diagram of heating temperature
High → Low On → Off	Heater turns off as shown in diagram of heating temperature <ul style="list-style-type: none"> • Other than Heating mode • Error occurred • Forced thermo off • Fan stop protection

Specifications of the signal output performance are as shown as follows:

Example: When set temperature (T_s) is set at 22 °C;

- And room temperature (T_r) increase above 12 °C, signal output is on.
- And T_r increase above 21 °C, signal output is off.
- And T_r decrease below 19 °C, signal output is on.
- And T_r decrease below 10 °C, signal output is off.

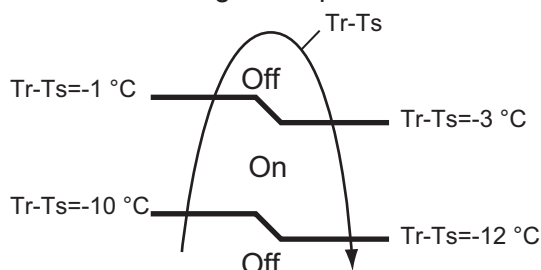

The output also turns off in defrost operation.