

# AIR CONDITIONER

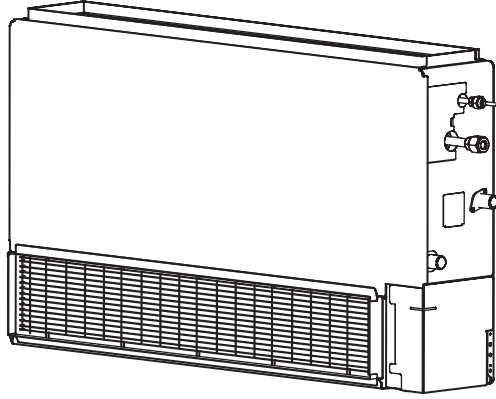
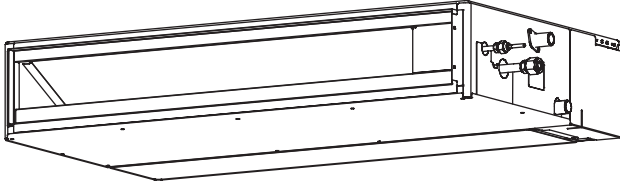

## INSTALLATION MANUAL

INDOOR UNIT (Duct Type)

For authorized service personnel only.

English

## INSTALLATIONSANLEITUNG

INNENGERÄT (Für Luftkanalsysteme)

Nur für autorisiertes Fachpersonal.

Deutsch

## MANUEL D'INSTALLATION

APPAREIL INTÉRIEURE (Type conduit)

Pour le personnel agréé uniquement.

Français

## MANUAL DE INSTALACIÓN

UNIDAD INTERIOR (Con conductos)

Sólo para personal de servicio autorizado.

Español

## MANUALE DI INSTALLAZIONE

UNITÀ INTERNA (Tipo di condotto)

Ad uso esclusivo del personale tecnico autorizzato.

Italiano

## ΕΓΧΕΙΡΙΔΙΟ ΕΓΚΑΤΑΣΤΑΣΗΣ

ΕΣΩΤΕΡΙΚΗ ΜΟΝΑΔΑ (Τύπος αγωγού)

Μόνο για εξουσιοδοτημένο τεχνικό προσωπικό.

Ελληνικά

## MANUAL DE INSTALAÇÃO

UNIDADE INTERIOR (Tipo conduta)

Apenas para pessoal de assistência autorizado.

Português

## РУКОВОДСТВО ПО УСТАНОВКЕ

ВНУТРЕННИЙ МОДУЛЬ (Канального типа)

Только для авторизованного обслуживающего персонала.

Русский

## MONTAJ KILAVUZU

İÇ ÜNİTE (Oluk tipi)

Yalnızca yetkili servis personeli için.

Türkçe

PART NO. 9374342235-02

# Contents

PART NO. 9374342235-02  
INDOOR UNIT (Duct Type)

|  |    |
|--|----|
| 1. SAFETY PRECAUTIONS.....   | 2  |
| 2. ABOUT THE UNIT.....   | 2  |
| 2.1. Precautions for using the R410A refrigerant.....                                | 2  |
| 2.2. Special tool for R410A.....   | 2  |
| 2.3. Accessories.....  | 3  |
| 2.4. Optional parts.....   | 3  |
| 3. INSTALLATION WORK.....  | 3  |
| 3.1. Selecting an installation location.....   | 3  |
| 3.2A. Installation dimensions (Ceiling concealed type).....                          | 4  |
| 3.2B. Installation dimensions (Wall mounted type/Floor standing concealed type)..... | 4  |
| 3.3A. Installation the unit (Ceiling concealed type).....                            | 4  |
| 3.3B. Install the unit (Wall mounted type/Floor standing concealed type).....        | 6  |
| 4. PIPE INSTALLATION.....  | 7  |
| 4.1. Selecting the pipe material.....  | 7  |
| 4.2. Pipe requirement.....   | 7  |
| 4.3. Flare connection (Pipe connection).....   | 8  |
| 4.4. Installing heat insulation.....   | 8  |
| 5. INSTALLING DRAIN PIPES.....   | 8  |
| 5.1A. When drain pump is used.....   | 8  |
| 5.1B. When drain pump is not used (Natural drainage).....                            | 9  |
| 5.2. Install the drain pipe.....   | 10 |
| 6. ELECTRICAL WIRING.....  | 11 |
| 6.1. Wiring system diagram.....  | 11 |
| 6.2. Connection cable preparation.....   | 13 |
| 6.3. Connection of wiring.....   | 13 |
| 7. REMOTE CONTROLLER SETTING.....  | 13 |
| 7.1. Installing the remote controller.....   | 13 |
| 7.2. Setting the dip switches.....   | 14 |
| 7.3. Function setting.....   | 14 |
| 7.4. Jumper wire setting.....  | 16 |
| 7.5. Special installation methods.....   | 16 |
| 8. TEST RUN.....   | 18 |
| 9. OPTIONAL PARTS.....   | 19 |
| 9.1. Wired remote controller (Simple remote controller).....                         | 19 |
| 9.2. External input and external output.....   | 19 |
| 9.3. Remote sensor (Optional parts).....   | 19 |
| 9.4. IR Receiver Unit (Optional parts).....  | 20 |
| 9.5. Auto louver grille (Optional parts).....  | 20 |
| 9.6. Optional parts cable binding.....   | 20 |
| 10. CUSTOMER GUIDANCE.....   | 20 |
| 11. ERROR CODES.....   | 20 |

## 1. SAFETY PRECAUTIONS

- Be sure to read this Manual thoroughly before installation.
- The warnings and precautions indicated in this Manual contain important information pertaining to your safety. Be sure to observe them.
- Hand this Manual, together with the Operating Manual to the customer. Request the customer to keep them on hand for future use, such as for relocating or repairing the unit.

**⚠ WARNING** This mark indicates procedures which, if improperly performed, might lead to the death or serious injury of the user.

**⚠ CAUTION** This mark indicates procedures which, if improperly performed, might possibly result in personal harm to the user, or damage to property.

### ⚠ WARNING

Request your dealer or a professional installer to install the unit in accordance with this Manual. An improperly installed unit can cause serious accidents such as water leakage, electric shock, or fire. If the unit is installed in disregard of the instructions in the Installation Manual, it will void the manufacturer's warranty.

Do not turn ON the power until all work has been completed. Turning ON the power before the work is completed can cause serious accidents such as electric shock or fire.

If refrigerant leaks while work is being carried out, ventilate the area. If the refrigerant comes in contact with a flame, it produces a toxic gas.

Installation work must be performed in accordance with national wiring standards by authorized personnel only.

Except for EMERGENCY, never turn off main as well as sub breaker of the indoor units during operation. It will cause compressor failure as well as water leakage. First, stop the indoor unit by operating the control unit, converter or external input device and then cut the breaker. Make sure to operate through the control unit, converter or external input device. When the breaker is designed, locate it at a place where the users cannot start and stop in the daily work.

### ⚠ CAUTION

Read carefully all security information before use or install the air conditioner.

Do not attempt to install the air conditioner or a part of the air conditioner by yourself.

This unit must be installed by qualified personnel with a capacity certificate for handling refrigerant fluids. Refer to regulation and laws in use on installation place.

The installation must be carried out in compliance with regulations in force in the place of installation and the installation instructions of the manufacturer.

This unit is part of a set constituting an air conditioner. It must not be installed alone or with non-authorized by the manufacturer.

Always use a separate power supply line protected by a circuit breaker operating on all wires with a distance between contact of 3mm for this unit.

The unit must be correctly earthed (grounded) and the supply line must be equipped with a differential breaker in order to protect the persons.

The units are not explosion proof and therefore should not be installed in explosive atmosphere.

Never touch electrical components immediately after the power supply has been turned off. Electric shock may occur. After turning off the power, always wait 5 minutes before touching electrical components.

This unit contains no user-serviceable parts. Always consult authorized service personnel to repairs.

When moving, consult authorized service personnel for disconnection and installation of the unit.

This appliance is not intended for use by persons (including children) with reduced physical, sensory or mental capabilities, or lack of experience and knowledge, unless they have been given supervision or instruction concerning use of the appliance by a person responsible for their safety. Children should be supervised to ensure that they do not play with the appliance.

## 2. ABOUT THE UNIT

### 2.1. Precautions for using the R410A refrigerant

#### ⚠ WARNING

Do not introduce any substance other than the prescribed refrigerant into the refrigeration cycle. If air enters the refrigeration cycle, the pressure in the refrigeration cycle will become abnormally high and cause the piping to rupture.

If there is a refrigerant leakage, make sure that it does not exceed the concentration limit. If a refrigerant leakage exceeds the concentration limit, it can lead to accidents such as oxygen starvation.

Do not touch refrigerant that has leaked from the refrigerant pipe connections or other area. Touching the refrigerant directly can cause frostbite.

If a refrigerant leakage occurs during operation, immediately vacate the premises and thoroughly ventilate the area. If the refrigerant comes in contact with a flame, it produces a toxic gas.

### 2.2. Special tool for R410A

#### ⚠ WARNING

To install a unit that uses the R410A refrigerant, use dedicated tools and piping materials that have been manufactured specifically for R410A use. Because the pressure of the R410A refrigerant is approximately 1.6 times higher than the R22, failure to use dedicated piping material or improper installation can cause rupture or injury. Furthermore, it can cause serious accidents such as water leakage, electric shock, or fire.

| Tool name            | Contents of change   |
|----------------------|--|
| Gauge manifold       | Pressure is huge and cannot be measured with a conventional gauge. To prevent erroneous mixing of other refrigerants, the diameter of each port has been changed. It is recommended to use a gauge manifold with a high pressure display range -0.1 to 5.3 MPa and a low pressure display range -0.1 to 3.8 MPa. |
| Charging hose        | To increase pressure resistance, the hose material and base size were changed.   |
| Vacuum pump          | A conventional vacuum pump can be used by installing a vacuum pump adapter.  |
| Gas leakage detector | Special gas leakage detector for HFC refrigerant R410A.  |

## 2.3. Accessories





### ⚠ WARNING



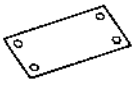
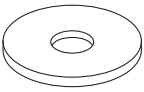
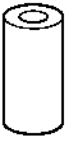

For installation purposes, be sure to use the parts supplied by the manufacturer or other prescribed parts. The use of non-prescribed parts can cause serious accidents such as the unit to fall, water leakage, electric shock, or fire.

The following installation parts are furnished. Use them as required.

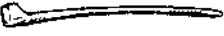
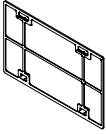
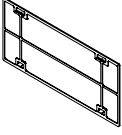
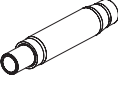
Keep the Installation Manual in a safe place and do not discard any other accessories until the installation work has been completed.

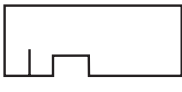
Do not discard any accessories needed for installation until the installation work has been completed.

| Name and Shape   | Q'ty                                  | Application  |
|--|---------------------------------------|--|
| Operating Manual<br>                  | 1                                     |  |
| Installation Manual<br>               | 1                                     | (This book)  |
| Installation template<br>             | 1                                     | For positioning the indoor unit  |
| Washer<br>                           | 8                                     | For installing indoor unit   |
| Coupler heat insulation (Large)<br> | 1                                     | For indoor side pipe joint (Large pipe)                                |
| Coupler heat insulation (Small)<br> | 1                                     | For indoor side pipe joint (Small pipe)                                |
| Cable-tie<br>                        | Medium<br>3                           | For power supply and transmission and remote controller cable binding. |
|  | Large<br>4                            | For fixing the coupler heat insulation.                                |
| Filter (Small)<br>                  | 2<br>(7000, 9000, 12000, 14000 Btu/h) |  |
| Filter (Large)<br>                  | 2<br>(18000 Btu/h)                    |  |
| Drain hose<br>                      | 1                                     | For installing drain pipe VP25 (O.D.32, I.D.25)                        |

| Name and Shape   | Q'ty | Application                          |
|--|------|--------------------------------------|
| Hose band<br>                  | 1    | For installing drain hose            |
| Drain hose insulation B<br>    | 1    | Insulates the drain hose             |
| Wired Remote Controller<br>    | 1    |                                      |
| Remote Controller Cable<br>    | 1    | For connecting the remote controller |
| Tapping screw (M4 × 16 mm)<br> | 2    | For installing the remote controller |

## 2.4. Optional parts

| Parts name               | Model No.  | Application                        |
|--------------------------|------------|------------------------------------|
| Wired remote controller  | UTY-RNN*M  | For air conditioner operation      |
| Simple Remote Controller | UTY-RSN*M  | For air conditioner operation      |
| IR Receiver Unit         | UTY-LRH*M  | For the wireless remote controller |
| Remote sensor unit       | UTY-XSZX   | Room temperature sensor            |
| External control set     | UTD-ECS5A  | For control input/output port      |
| Auto louver grille       | UTD-G*S*-W | Air outlet grille with auto louver |

## 3. INSTALLATION WORK

### 3.1. Selecting an installation location

Especially, the installation place is very important for the split type air conditioner because it is very difficult to move from place to place after the first installation.

### ⚠ WARNING

Select installation locations that can properly support the weight of the indoor. Install the units securely so that they do not topple or fall.

### ⚠ CAUTION

Do not install the unit in the following areas:

- Area with high salt content, such as at the seaside. It will deteriorate metal parts, causing the parts to fail or the unit to leak water.
- Area filled with mineral oil or containing a large amount of splashed oil or steam, such as a kitchen. It will deteriorate plastic parts, causing the parts to fail or the unit to leak water.
- Area that generates substances that adversely affect the equipment, such as sulfuric gas, chlorine gas, acid, or alkali. It will cause the copper pipes and brazed joints to corrode, which can cause refrigerant leakage.
- Area that can cause combustible gas to leak, contains suspended carbon fibers or flammable dust, or volatile inflammables such as paint thinner or gasoline. If gas leaks and settles around the unit, it can cause a fire.
- Area where animals may urinate on the unit or ammonia may be generated.

Do not use the unit for special purposes, such as storing food, raising animals, growing plants, or preserving precision devices or art objects. It can degrade the quality of the preserved or stored objects.

Do not install where there is the danger of combustible gas leakage.

Do not install the unit near a source of heat, steam, or flammable gas.

Install the unit where drainage does not cause any trouble.

Install the indoor unit, outdoor unit, power supply cable, transmission cable, and remote controller cable at least 1 m away from a television or radio receivers. The purpose of this is to prevent TV reception interference or radio noise. (Even if they are installed more than 1 m apart, you could still receive noise under some signal conditions.)

**CAUTION**

If children under 10 years old may approach the unit, take preventive measures so that they cannot reach the unit.

**Decide the mounting position with the customer as follows:**

- (1) Install the indoor unit in a location having sufficient strength to support the weight of the indoor unit.
- (2) The inlet and outlet ports should not be obstructed; the air should be able to blow all over the room.
- (3) Leave the space required to service the air conditioner.
- (4) Locate where the air can be distributed evenly throughout the room by the unit.
- (5) Install the unit where connection to the outdoor unit is easy.
- (6) Install the unit where the connection pipe can be easily installed.
- (7) Install the unit where the drain pipe can be easily installed.
- (8) Install the unit where noise and vibration is not amplified.
- (9) Take servicing, etc., into consideration and leave the spaces. Also install the unit where the filter can be removed.

**3.2A. Installation dimensions (Ceiling concealed type)**

Provide a Service access for inspection purposes.  
Do not place any wiring or illumination in the service space, as they will impede service.  
Installation Dimensions

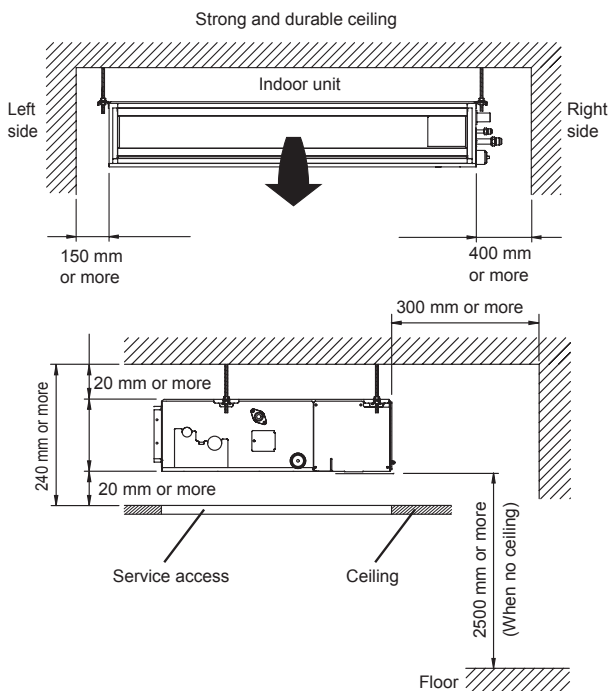

Adjust the wind direction in the room depending on the shape of blow out opening.  
Service access

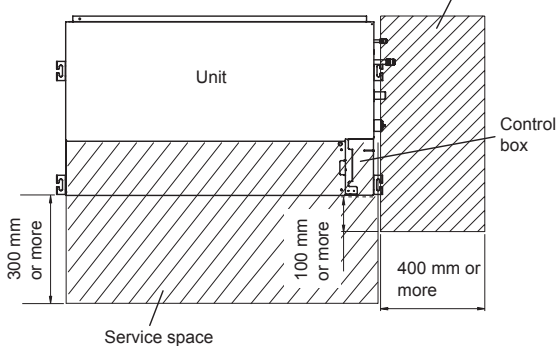

**3.2B. Installation dimensions (Wall mounted type/Floor standing concealed type)**

The wall mounted type/floor standing concealed type requires a temperature correction setting. Perform this in "7.3. Function setting".

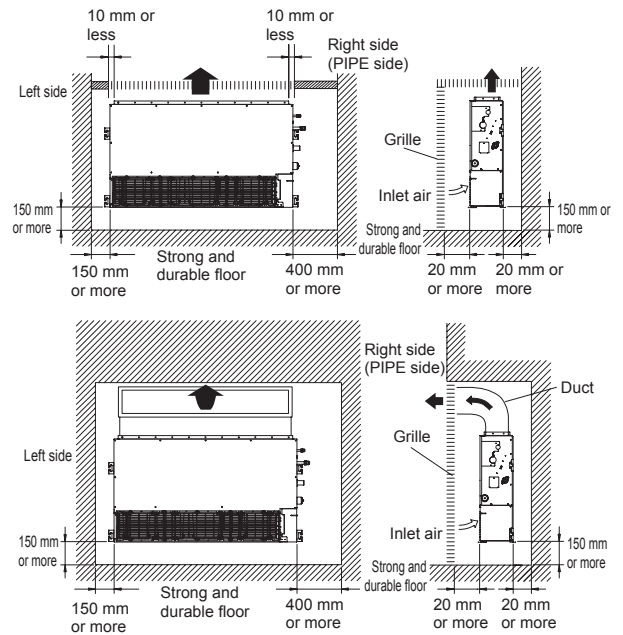

**3.3A. Installation the unit (Ceiling concealed type)**

**WARNING**

Install the air conditioner in a location which can withstand a load do at least 5 times the weight of the main unit and which will not amplify sound or vibration. If the installation location is not strong enough, the indoor unit may fall and cause injuries.

If the job is done with the panel frame only, there is a risk that the unit will come loose. Please take care.

**3.3A.1. UNIT INSTALLATION EXAMPLE (CEILING CONCEALED TYPE)**

Connect the locally purchased duct.

- (1) Inlet side
  - Connect the duct to the locally purchased inlet flange.
  - Connect the flange to the body with the locally purchased tapping screws.
  - Wind the inlet flange connecting to the duct with the aluminum tape etc. to avoid the air discharge.

**CAUTION**

When the duct is connected to inlet side, remove contained filter and surely attach locally purchased filter at inlet opening.

- (2) Outlet side
  - Connect the duct with adjusting inside of outlet flange.
  - Wind the outlet flange connecting to the duct with the aluminum tape etc. to avoid the air discharge.
  - Insulate the duct to avoid the dew condensation.

**CAUTION**

Check that duct work does not exceed the range of external static pressure of equipment.

Make sure to insulate ducts to avoid the dew condensation.

Make sure to insulate between ducts and walls if metal ducts are used.

Please explain handling and washing methods of locally purchased materials to the customer.

To prevent people from touching the parts inside the unit, be sure to install grilles on the inlet and outlet ports. The grilles must be designed in such a way that cannot be removed without tools.

When connecting the duct to the outlet port of the indoor unit, be sure to insulate the outlet port and the installation screws to prevent water from leaking around the port.

Set the static pressure outside the unit to 90 Pa or less (the allowable range is between 0 and 90 Pa.)

Replace the cover as follows.

- Remove the screws, and then remove cover and fan guard.
- Install the cover with the screws as shown in the illustration below.

| Model                          | Screw |
|--------------------------------|-------|
| 7000, 9000, 12000, 14000 Btu/h | 9     |
| 18000 Btu/h                    | 11    |

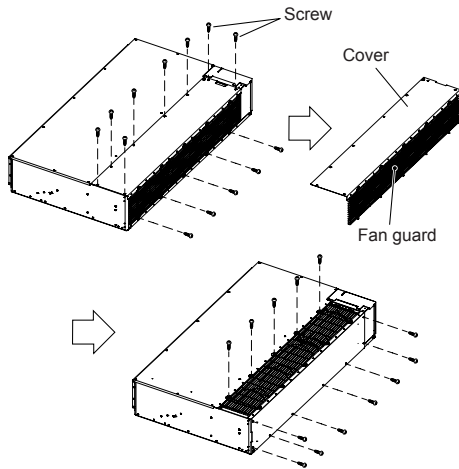

#### Side Inlet - Side Outlet

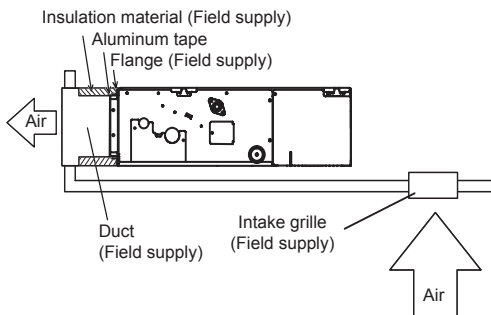

#### Side Inlet - Side Outlet (Duct)

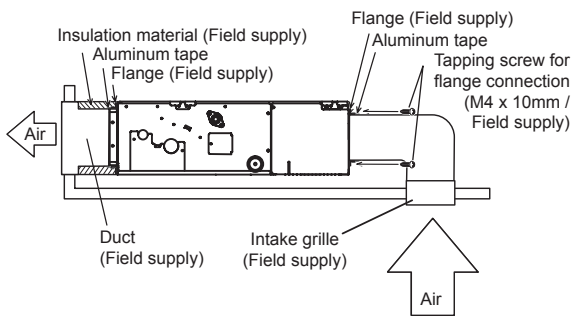

#### Bottom Inlet - Side Outlet

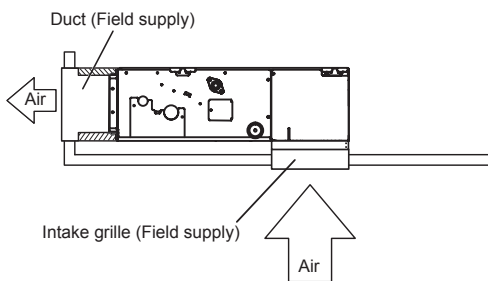

#### Outlet side

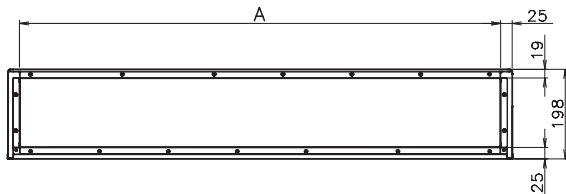

#### Inlet side

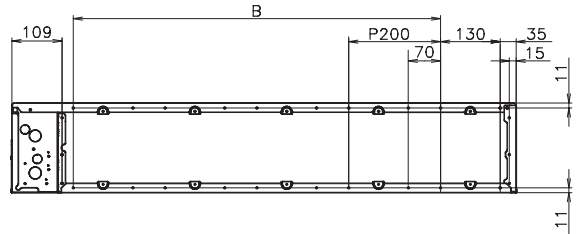

|   | 7000, 9000, 12000, 14000 Btu/h | 18000 Btu/h   |
|---|--------------------------------|---------------|
| A | 650 mm                         | 850 mm        |
| B | P200×2=400 mm                  | P200×3=600 mm |

#### CAUTION

Be sure to install the air inlet grille and the air outlet grille for air circulation. The correct temperature cannot be detected.

Grills must be fixed so that man cannot touch indoor unit fan and exchanger, and cannot be removed by only hand operation without tool.

Be sure to install the air filter in the air inlet.

If the air filter is not installed, the heat exchanger may be clogged and its performance may decrease.

### 3.3A.2. INSTALL THE FILTERS

- Install the filters to the unit.

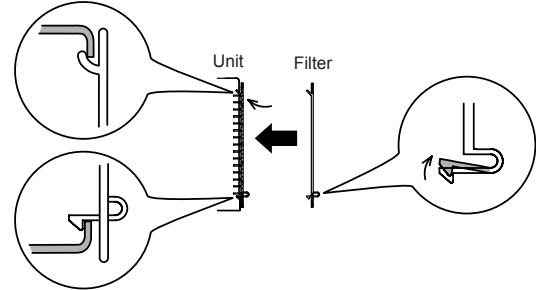
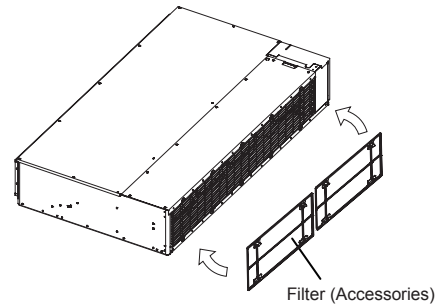

### 3.3A.3. DRILLING HOLES FOR BOLTS AND INSTALLING THE BOLTS

- Using the installation template, drill holes for bolts (4 holes).

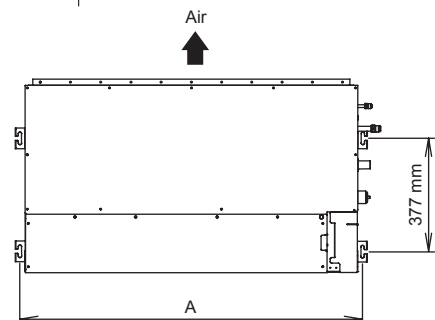
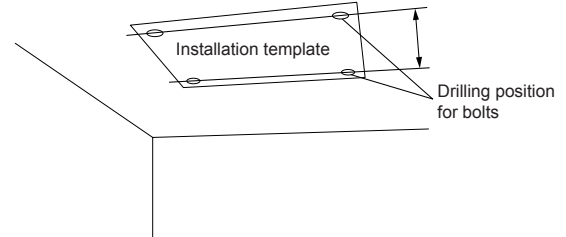

|   | 7000, 9000, 12000, 14000 Btu/h | 18000 Btu/h |
|---|--------------------------------|-------------|
| A | 734 mm                         | 934 mm      |

### 3.3A.4. FIX THE UNIT

(1) Hang the unit

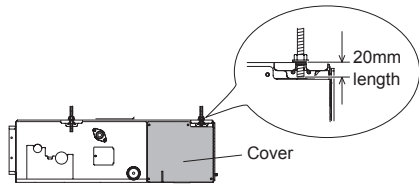
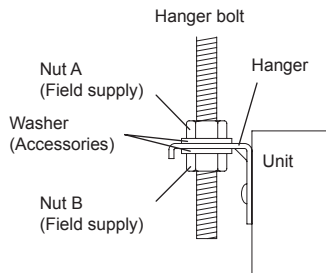
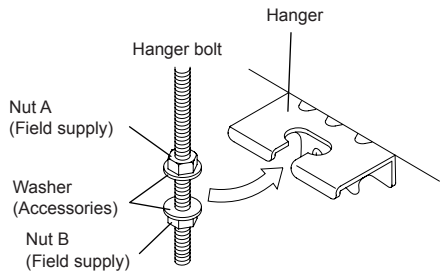

\*: It might become difficult to open and shut the Cover /control box cover when the length exceeds 20mm.

(2) Leveling

Base horizontal direction leveling on top of the unit.

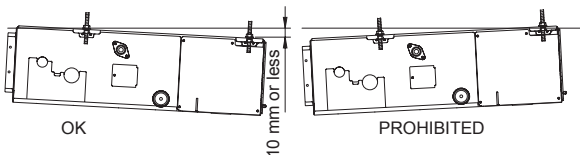
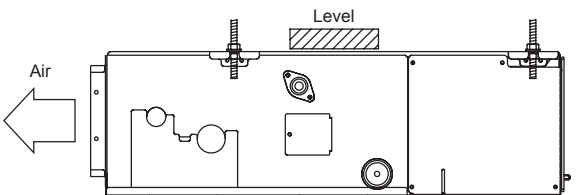
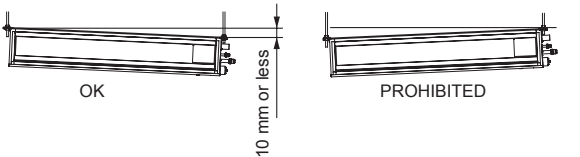
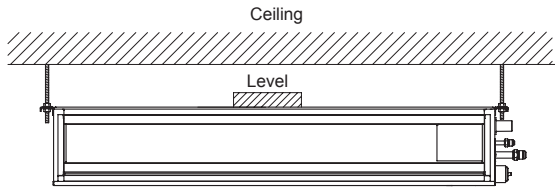

### CAUTION

Leave a space of 100 mm or more between the inlet port and the ceiling.

Fasten the unit securely with Special nuts A and B.

### 3.3B. Install the unit (Wall mounted type/Floor standing concealed type)

#### WARNING

Install the air conditioner in a location which can withstand a load do at least 5 times the weight of the main unit and which will not amplify sound or vibration. If the installation location is not strong enough, the indoor unit may fall and cause injuries.

If the job is done with the panel frame only, there is a risk that the unit will come loose. Please take care.

#### 3.3B.1. UNIT INSTALLATION EXAMPLE

##### (Wall mounted type/Floor standing concealed type)

Connect the locally purchased duct.

(1) Inlet side

- Connect the duct to the locally purchased inlet flange.
- Connect the flange to the body with the locally purchased tapping screws.
- Wind the inlet flange connecting to the duct with the aluminum tape etc. to avoid the air leakage.

#### CAUTION

When the duct is connected to inlet side, remove contained filter and surely attach locally purchased filter at inlet opening.

(2) Outlet side

- Connect the duct with adjusting inside of outlet flange.
- Wind the outlet flange connecting to the duct with the aluminum tape etc. to avoid the air discharge.
- Insulate the duct to avoid the dew condensation.

#### CAUTION

Check that duct work does not exceed the range of external static pressure of equipment.

Make sure to insulate ducts to avoid the dew condensation.

Make sure to insulate between ducts and walls if metal ducts are used.

Please explain handling and washing methods of locally purchased materials to the customer.

To prevent people from touching the parts inside the unit, be sure to install grilles on the inlet and outlet ports. The grilles must be designed in such a way that cannot be removed without tools.

When connecting the duct to the outlet port of the indoor unit, be sure to insulate the outlet port and the installation screws to prevent water from leaking around the port.

Set the static pressure outside the unit to 90 Pa or less (the allowable range is between 0 and 90 Pa.)

- Remove the screws, and then remove cover and fan guard.
- Install the cover with the screws as shown in the illustration below.

| Model                          | Screw |
|--------------------------------|-------|
| 7000, 9000, 12000, 14000 Btu/h | 9     |
| 18000 Btu/h                    | 11    |

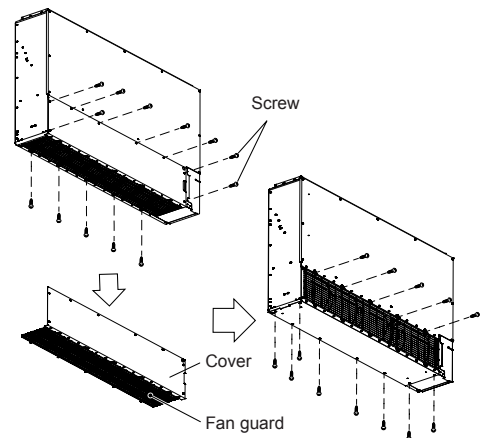

### 3.3B.2. INSTALL THE FILTER

- Install the filters (Accessories) to the unit.

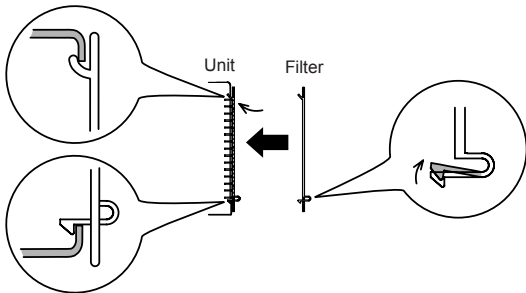
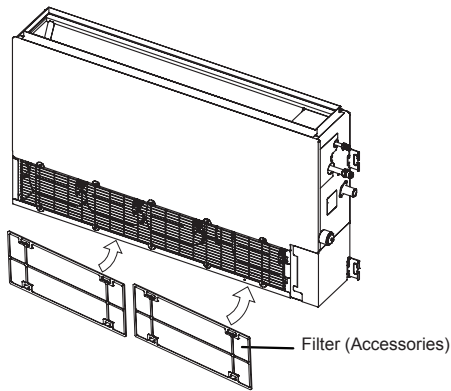

### 3.3B.3. INSTALLING THE UNIT

#### (1) Fixing method of the unit

- To prevent overturning, fix the unit to the floor or the wall.
- To avoid the vibration of the unit, insert the spacer between the unit and the floor or the wall, and fix it.

#### (2) Leveling

Base horizontal direction leveling on top of the unit.

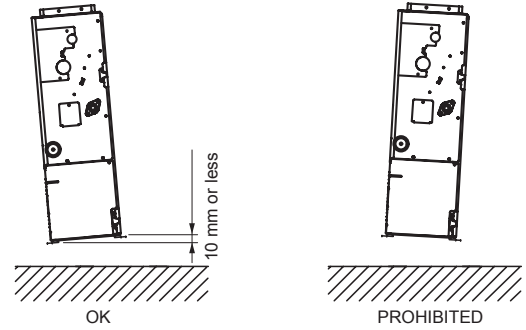
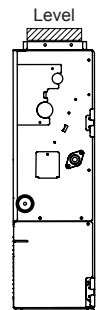
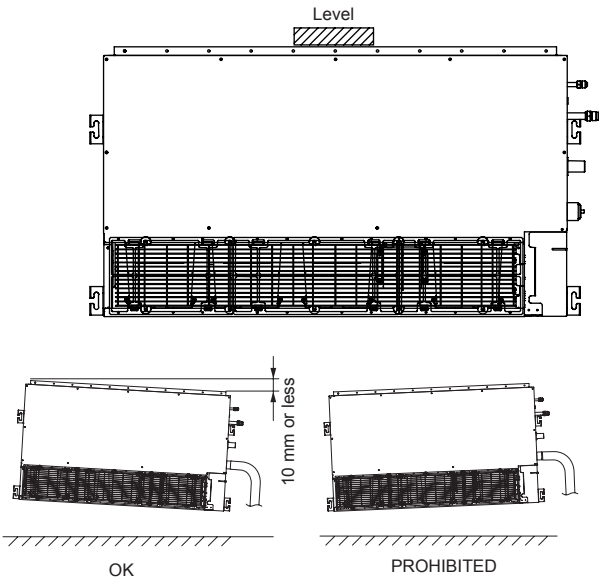

#### ⚠ CAUTION

Fasten the unit securely with Special nuts A and B.

## 4. PIPE INSTALLATION

#### ⚠ CAUTION

Be careful that foreign matter (oil, water, etc.) does not enter the piping with refrigerant R410A models. Also, when storing the piping, securely seal the openings by pinching, taping, etc.

While brazing the pipes, be sure to purge with dry nitrogen gas.

### 4.1. Selecting the pipe material

#### ⚠ CAUTION

Do not use existing pipes.

Use pipes that have clean external and internal sides without any contamination which may cause trouble during use, such as sulfur, oxide, dust, cutting waste, oil, or water.

It is necessary to use seamless copper pipes.

Material : Phosphor deoxidized seamless copper pipes

It is desirable that the amount of residual oil is less than 40 mg/10 m.

Do not use copper pipes that have a collapsed, deformed, or discolored portion (especially on the interior surface). Otherwise, the expansion valve or capillary tube may become blocked with contaminants.

Improper pipe selection will degrade performance. As an air conditioner using R410A incurs pressure higher than when using conventional refrigerant, it is necessary to choose adequate materials.

- Thicknesses of copper pipes used with R410A are as shown in the table.
- Never use copper pipes thinner than those indicated in the table even if they are available on the market.

#### Thicknesses of Annealed Copper Pipes (R410A)

| Pipe outside diameter [mm (in.)] | Thickness [mm] |
|----------------------------------|----------------|
| 6.35 (1/4)                       | 0.80           |
| 9.52 (3/8)                       | 0.80           |
| 12.70 (1/2)                      | 0.80           |
| 15.88 (5/8)                      | 1.00           |
| 19.05 (3/4)                      | 1.20           |

### 4.2. Pipe requirement

#### ⚠ CAUTION

Refer to the Installation Manual of the outdoor unit for description of the length of connecting pipe or for difference of its elevation.

- Use pipe with water-resistant heat insulation.

#### ⚠ CAUTION

Install heat insulation around both the gas and liquid pipes. Failure to do so may cause water leaks.

Use heat insulation with heat resistance above 120 °C. (Reverse cycle model only)  
In addition, if the humidity level at the installation location of the refrigerant piping is expected to exceed 70 %, install heat insulation around the refrigerant piping. If the expected humidity level is 70-80 %, use heat insulation that is 15 mm or thicker and if the expected humidity exceeds 80 %, use heat insulation that is 20 mm or thicker. If heat insulation is used that is not as thick as specified, condensation may form on the surface of the insulation. In addition, use heat insulation with heat conductivity of 0.045 W/(m·K) or less (at 20 °C).

### 4.3. Flare connection (Pipe connection)

#### ⚠ WARNING

Tighten the flare nuts with a torque wrench using the specified tightening method. Otherwise, the flare nuts could break after a prolonged period, causing refrigerant to leak and generate a hazardous gas if the refrigerant comes into contact with a flame.

#### 4.3.1. Flaring

- Use special pipe cutter and flare tool exclusive for R410A.
- Cut the connection pipe to the necessary length with a pipe cutter.
- Hold the pipe downward so that cuttings will not enter the pipe and remove any burrs.
- Insert the flare nut (always use the flare nut attached to the indoor and outdoor units respectively) onto the pipe and perform the flare processing with a flare tool. Use the special R410A flare tool, or the conventional flare tool. Leakage of refrigerant may result if other flare nuts are used.
- Protect the pipes by pinching them or with tape to prevent dust, dirt, or water from entering the pipes.

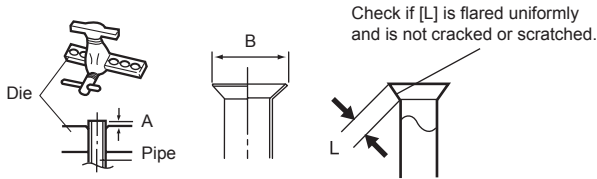

| Pipe outside diameter [mm (in.)] | Dimension A [mm]                  | Dimension B <sub>0.4</sub> [mm] |
|----------------------------------|-----------------------------------|---------------------------------|
|                                  | Flare tool for R410A, clutch type |                                 |
| 6.35 (1/4)                       | 0 to 0.5                          | 9.1                             |
| 9.52 (3/8)                       |                                   | 13.2                            |
| 12.70 (1/2)                      |                                   | 16.6                            |
| 15.88 (5/8)                      |                                   | 19.7                            |
| 19.05 (3/4)                      |                                   | 24.0                            |

When using conventional flare tools to flare R410A pipes, the dimension A should be approximately 0.5 mm more than indicated in the table (for flaring with R410A flare tools) to achieve the specified flaring. Use a thickness gauge to measure the dimension A.

| Width across flats | Pipe outside diameter [mm (in.)] | Width across flats of Flare nut [mm] |
|--------------------|----------------------------------|--------------------------------------|
|                    | 6.35 (1/4)                       | 17                                   |
|                    | 9.52 (3/8)                       | 22                                   |
|                    | 12.70 (1/2)                      | 26                                   |
|                    | 15.88 (5/8)                      | 29                                   |
|                    | 19.05 (3/4)                      | 36                                   |

#### 4.3.2. Bending pipes

- If pipes are shaped by hand, be careful not to collapse them.
- Do not bend the pipes in an angle more than 90°.
- When pipes are repeatedly bent or stretched, the material will harden, making it difficult to bend or stretch them any more.
- Do not bend or stretch the pipes more than 3 times.

#### ⚠ CAUTION

To prevent breaking of the pipe, avoid sharp bends.

If the pipe is bent repeatedly at the same place, it will break.

#### 4.3.3. Pipe connection

#### ⚠ CAUTION

Be sure to install the pipe against the port on the indoor unit correctly. If the centering is improper, the flare nut cannot tighten smoothly. If the flare nut is forced to turn, the threads will be damaged.

Do not remove the flare nut from the indoor unit pipe until immediately before connecting the connection pipe.

Hold the torque wrench at its grip, keeping it at a right angle with the pipe, in order to tighten the flare nut correctly.

Tighten the flare nuts with a torque wrench using the specified tightening method. Otherwise, the flare nuts could break after a prolonged period, causing refrigerant to leak and generate a hazardous gas if the refrigerant comes into contact with a flame.

Connect the piping so that the control box cover can easily be removed for servicing when necessary.

In order to prevent water from leaking into the control box, make sure that the piping is well insulated.

When the flare nut is tightened properly by your hand, hold the body side coupling with a separate spanner, then tighten with a torque wrench. (See the table below for the flare nut tightening torques.)

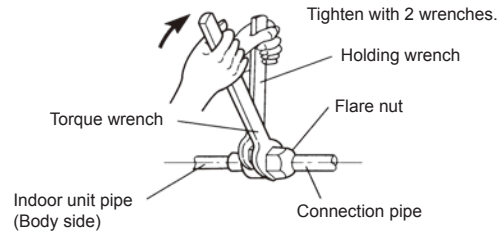

| Flare nut [mm (in.)] | Tightening torque [N·m (kgf·cm)] |
|----------------------|----------------------------------|
| 6.35 (1/4) dia.      | 16 to 18 (160 to 180)            |
| 9.52 (3/8) dia.      | 32 to 42 (320 to 420)            |
| 12.70 (1/2) dia.     | 49 to 61 (490 to 610)            |
| 15.88 (5/8) dia.     | 63 to 75 (630 to 750)            |
| 19.05 (3/4) dia.     | 90 to 110 (900 to 1,100)         |

### 4.4. Installing heat insulation

Install the heat insulation material after performing a refrigerant leak check (see the Installation Manual for the outdoor unit for details).

#### 4.4.1. COUPLER HEAT INSULATION

- Insulate with the coupler heat insulation (Accessories) around the gas pipe and liquid pipe at indoor unit.
- After installing the coupler heat insulation, wrap both ends with vinyl tape so that there is no gap.
- After affixing the coupler heat insulation, secure it with 2 cable-tie (large), one on each end of the insulation.
- Make sure that the cable-tie overlap the heat insulation pipe.

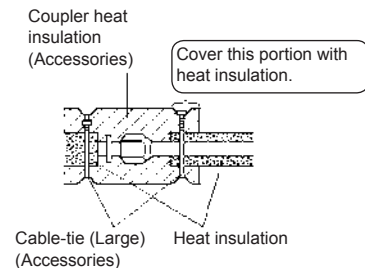

#### ⚠ CAUTION

After checking for gas leaks (refer to the Installation Manual of the outdoor unit), perform this section.

Install heat insulation around both the large (gas) and small (liquid) pipes. Failure to do so may cause water leaks.

### 5. INSTALLING DRAIN PIPES

#### ⚠ WARNING

Do not insert the drain piping into the sewer where sulfurous gas occurs. (Heat exchange erosion may occur)

Insulate the parts properly so that water will not drip from the connection parts.

Check for proper drainage after the construction by using the visible portion of transparent drain port and the drain piping final outlet on the body.

#### ⚠ CAUTION

Do not apply adhesive agent on the drain port of the body. (Use the attached drain hose and connect the drain piping)

#### 5.1A. When drain pump is used

- Use general hard polyvinyl chloride pipe (VP25) [outside diameter 32 mm].
- Do not perform a rise, trap and air bleeding.
- Provide a downward gradient (1/100 or more).
- Provide supporters when long pipes are installed.
- Use an insulation material as needed, to prevent the pipes from freezing.
- Install the pipes in a way that allows for the removal of the control box.



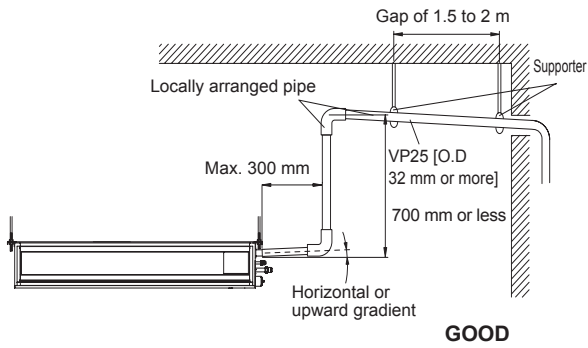

**GOOD**

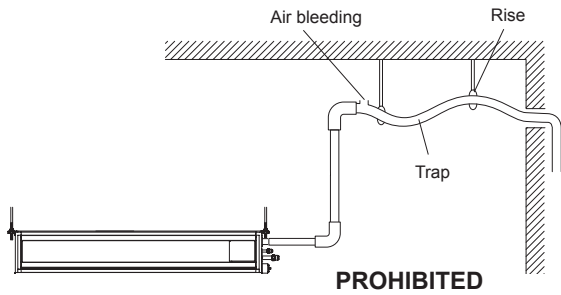

**PROHIBITED**

Observe the following procedures to construct centralized drain pipe fittings.

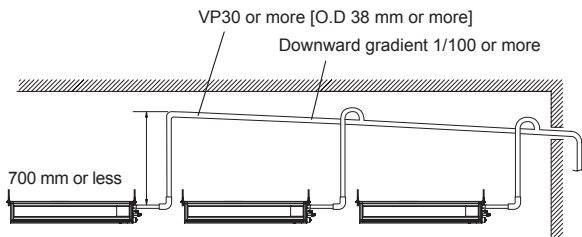

### 5.1B. When drain pump is not used (Natural drainage)

#### CAUTION

Set "Drainage function setting (JM1)" in "7.4 Jumper wire setting."  
Drain pump cannot be used if it is installed in wall mounted type/floor standing concealed type.

If the drain pump is not used, please replace with the drain cap.

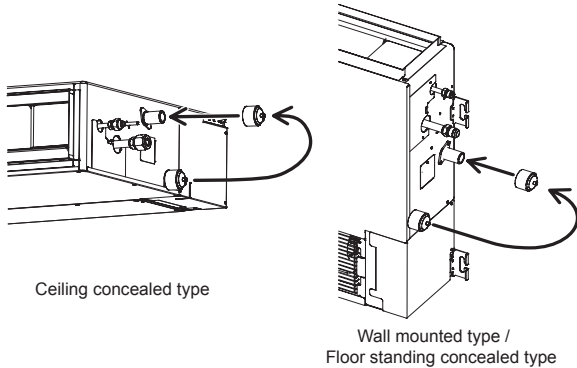

- Use general hard polyvinyl chloride pipe (VP25) [outside diameter 32 mm].
- Do not perform a rise, trap and air bleeding.
- Provide a downward gradient (1/100 or more).
- Provide supporters when long pipes are installed.
- Use an insulation material as needed, to prevent the pipes from freezing.
- Install the pipes in a way that allows for the removal of the control box.

### (1) Ceiling concealed type

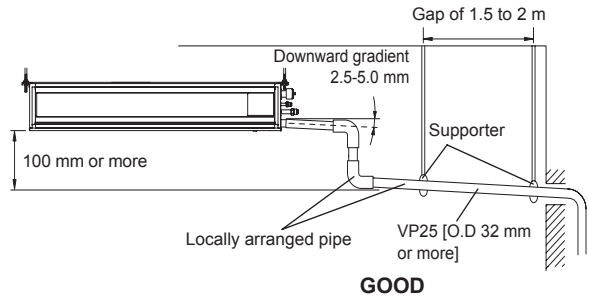

**GOOD**

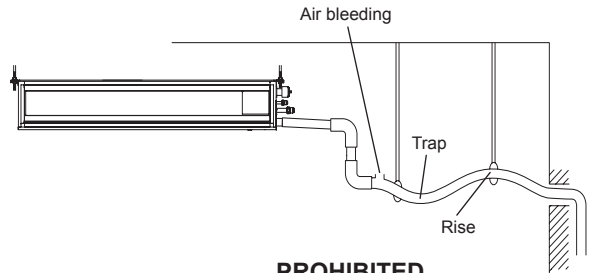

**PROHIBITED**

Observe the following procedures to construct centralized drain pipe fittings.

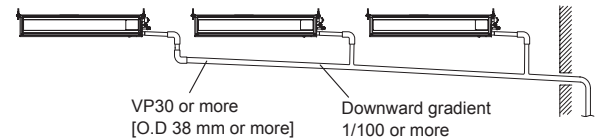

### (2) Wall mounted type / Floor standing concealed type

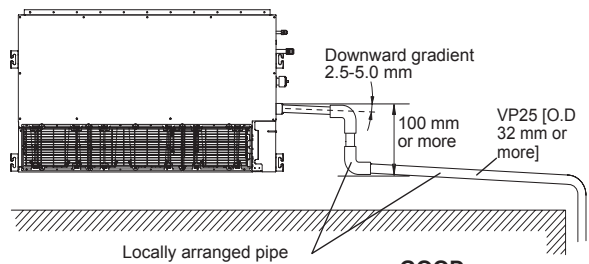

**GOOD**

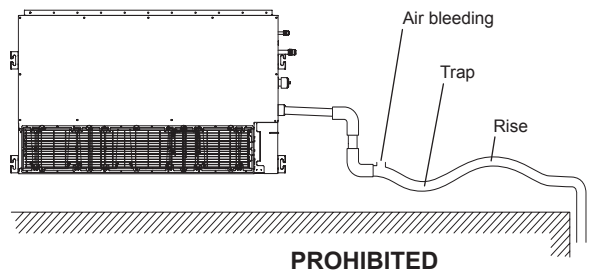

**PROHIBITED**

Observe the following procedures to construct centralized drain pipe fittings.

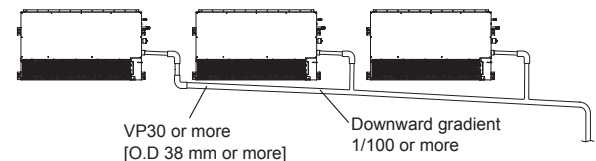

## 5.2. Install the drain pipe

(1) Be sure to use supplied Drain hose ① and Hose band ②

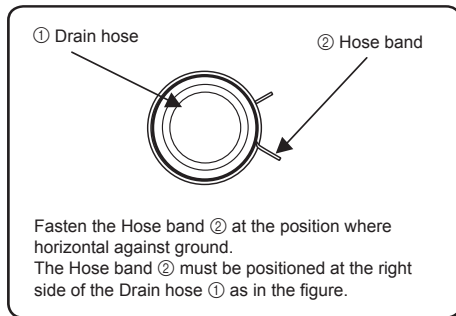
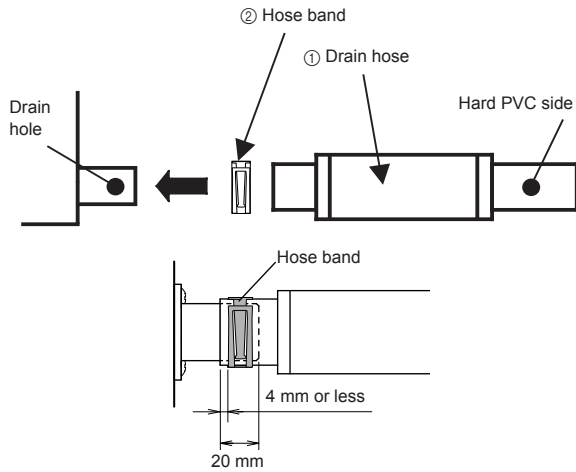

(2) Be sure to connect Drain pipe with adhesive (polyvinyl chloride) so that there is no leakage.

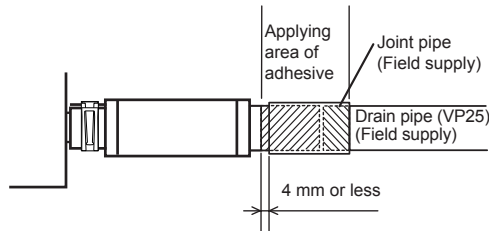

### CAUTION

Do not connect to the Drain hole with adhesive. Using adhesive may cause damage and water leaks.

(3) After installing the Drain hose ①, check if the drainage is smooth.

### CAUTION

To prevent excessive force on Drain hose ①, avoid bends or twists. (To bend or twist may cause water leaks.)

(4) After checking for drainage, attach the Drain hose insulation B ③ to insulate, following the instructions as in the figures.

To avoid space with Drain hose ① and Hose band ②, press firmly the Drain hose insulation B ③.

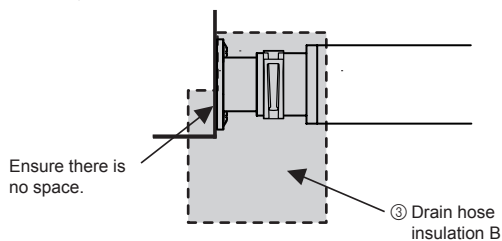

• STEP1~STEP3

Butt the insulation against the unit.

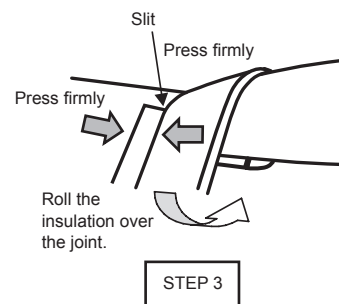
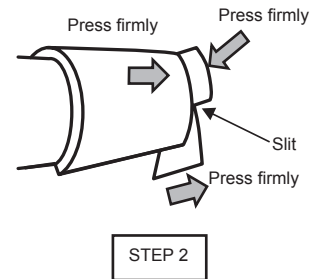
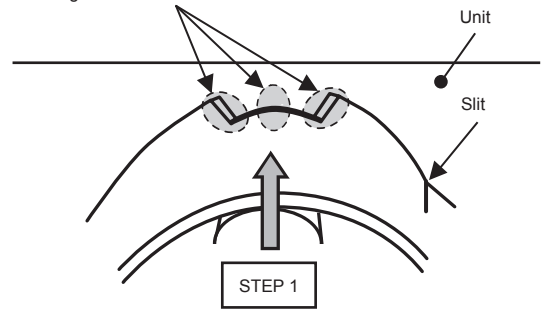

• FINISH

Check that there is no gap between the unit and the drain hose insulation.

• When drain pump is used. (Ceiling concealed type only)

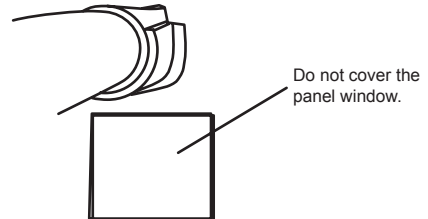

• When drain pump is not used. (Natural drainage)

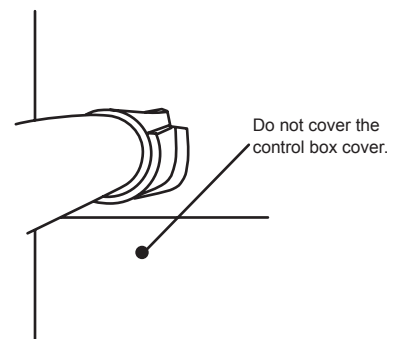

**Note: Check for drainage**

Pour about 1 liter of water from the position shown in the diagram or from the airflow outlet to the dew tray. Check for any abnormalities such as strange noises and whether the drain pump functions normally.

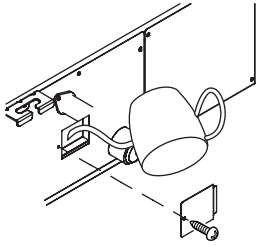

**CAUTION**

- Make sure the drain water is properly drained.

**6. ELECTRICAL WIRING**

**WARNING**

Electrical work must be performed in accordance with this Manual by a person certified under the national or regional regulations. Be sure to use a dedicated circuit for the unit.

An insufficient power supply circuit or improperly performed electrical work can cause serious accidents such as electric shock or fire.

Before starting work, check that power is not being supplied to the indoor unit and outdoor unit.

For wiring, use the prescribed type of cables, connect them securely, making sure that there are no external forces of the cables applied to the terminal connections. Improperly connected or secured cables can cause serious accidents such as overheating the terminals, electric shock, or fire.

Securely install the electrical box cover on the unit. An improperly installed electrical box cover can cause serious accidents such as electric shock or fire through exposure to dust or water.

Install sleeves into any holes made in the walls for wiring. Otherwise, a short circuit could result.

Use the included connection cables and power cables or ones specified by the manufacturer. Improper connections, insufficient insulation, or exceeding the allowable current can cause electric shock or fire.

Do not modify the power cables, use extension cables, or use any branches in the wiring. Improper connections, insufficient insulation, or exceeding the allowable current can cause electric shock or fire.

Match the terminal block numbers and connection cable colors with those of the outdoor unit or branch box. Erroneous wiring may cause burning of the electric parts.

Securely connect the connection cables to the terminal board. In addition, secure the cables with wiring holders. Improper connections, either in the wiring or at the ends of the wiring, can cause a malfunction, electric shock, or fire.

Always fasten the outside covering of the connection cable with the cable clamp. (If the insulator is chafed, electric leakage may occur.)

Install an earth leakage breaker. In addition, install the earth leakage breaker so that the entire AC main power supply is cut off at the same time. Otherwise, electric shock or fire could result.

Always connect the earth (ground) cable. Improper earthing (grounding) work can cause electric shocks.

Perform wiring work in accordance with standards so that the air conditioner can be operated safely and positively.

Connect the connection cable firmly to the terminal board. Imperfect installation may cause a fire.

**CAUTION**

Earth (Ground) the unit. Do not connect the earth (ground) cable to a gas pipe, water pipe, lightning rod, or a telephone earth (ground) cable. Improper earthing (grounding) may cause electric shock.

Install the remote controller cables so as not to be direct touched with your hand.

Do not connect power supply cables to the transmission or remote controller terminals, as this will damage the product.

Never bundle the power supply cable and transmission cable, remote controller cable together. Separate these cable by 50 mm or more. Bundling these cables together will cause miss operation or breakdown.

When handling PCB, static electricity charged in the body may cause malfunction of the PCB. Follow the cautions below:

- Establish an earth (a ground) for the indoor and outdoor units and peripheral devices.
- Cut power (breaker) off.
- Touch metal part of the indoor and outdoor units for more than 10 seconds to discharge static electricity charged in the body.
- Do not touch terminals of parts and patterns implemented on PCB.

- (1) Use ring terminals with insulating sleeves as shown in the figure below to connect to the terminal block.
- (2) Securely clamp the ring terminals to the cables using an appropriate tool so that the cables do not come loose.
- (3) Use the specified cables, connect them securely, and fasten them so that there is no stress placed on the terminals.
- (4) Use an appropriate screwdriver to tighten the terminal screws. Do not use a screwdriver that is too small, otherwise, the screw heads may be damaged and prevent the screws from being properly tightened.
- (5) Do not tighten the terminal screws too much, otherwise, the screws may break. See the table for the terminal screw tightening torques.
- (6) Please do not fix 2 power supply cables with 1 screw.

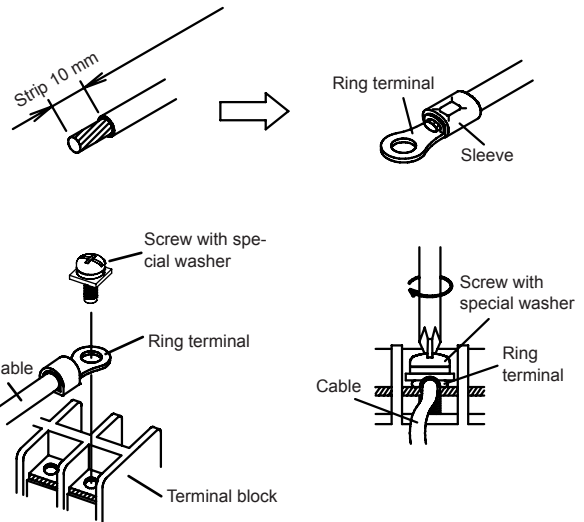

**WARNING**

Use ring terminals and tighten the terminal screws to the specified torques, otherwise, abnormal overheating may be produced and possibly cause heavy damage inside the unit.

**Tightening torque**

|          |                                     |
|----------|-------------------------------------|
| M4 screw | 1.2 to 1.8 N·m<br>(12 to 18 kgf·cm) |
|----------|-------------------------------------|

**6.1. Wiring system diagram**

| Cable            | Cable size (mm <sup>2</sup> ) | Type             | Remarks                         |
|------------------|-------------------------------|------------------|---------------------------------|
| Connection cable | 1.5 (MIN.)                    | Type 60245 IEC57 | 3Cable+Earth (Ground), 1φ 230 V |

Max. Cable Length: Limit voltage drop to less than 2%. Increase cable gauge if voltage drop is 2% or more.

For simultaneous multi

|          | Conductor size (mm <sup>2</sup> ) | Max length (m) |
|----------|-----------------------------------|----------------|
| Bus wire | 0.3 (MIN.)                        | 500*           |

\*This length shall be the total extended length in the system of the group. (Total length of bus wire and remote controller cable.)

## Connection diagrams

### Standard pair

#### Connection cable

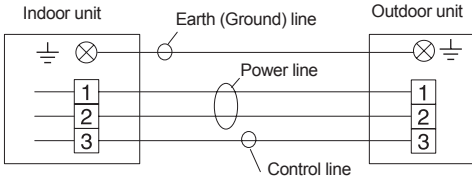

#### Wired remote controller cable

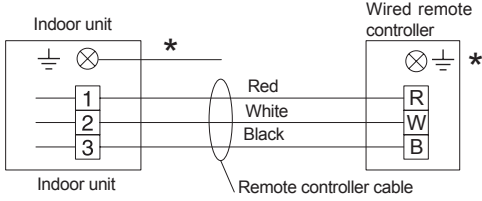

\*Earth (Ground) the remote controller if it has a earth (ground) line.

### Flexible multi

#### Connection cable

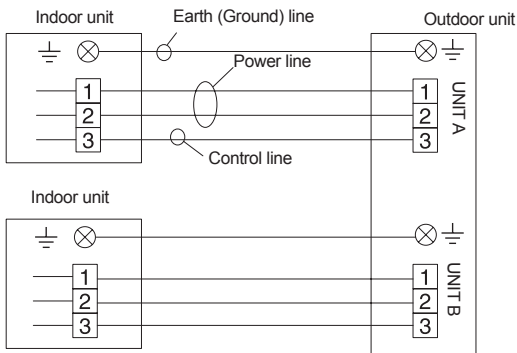

#### Wired remote controller cable

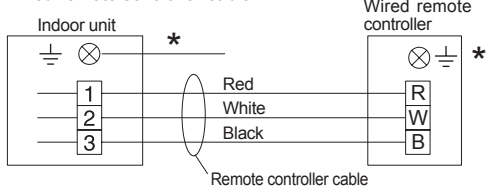

\*Earth (Ground) the remote controller if it has a earth ground) line.

### Flexible multi (branch box)

#### Connection cable

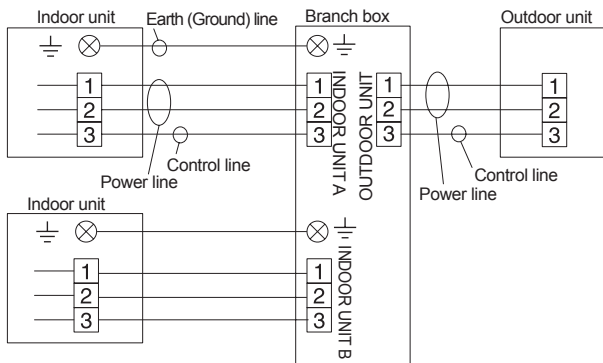

#### Wired remote controller cable

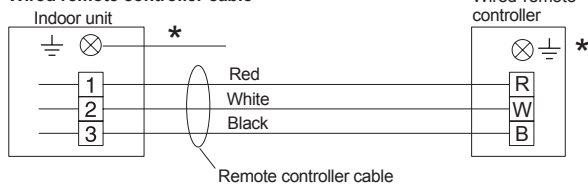

\*Earth (Ground) the remote controller if it has a earth ground) line.

### Simultaneous twin (18, 22, 24 type only)

#### Connection cable

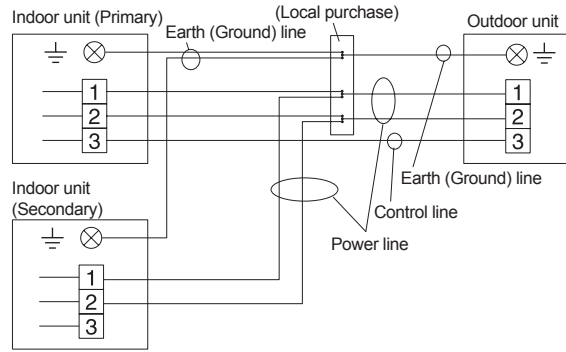

#### Wired remote controller cable

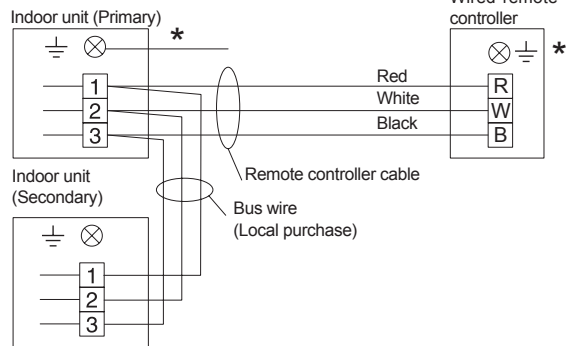

\*Earth (Ground) the remote controller if it has a earth (ground) line.  
• Connect the remote controller wires to the primary unit.

### Simultaneous triple (18 type only)

#### Connection cable

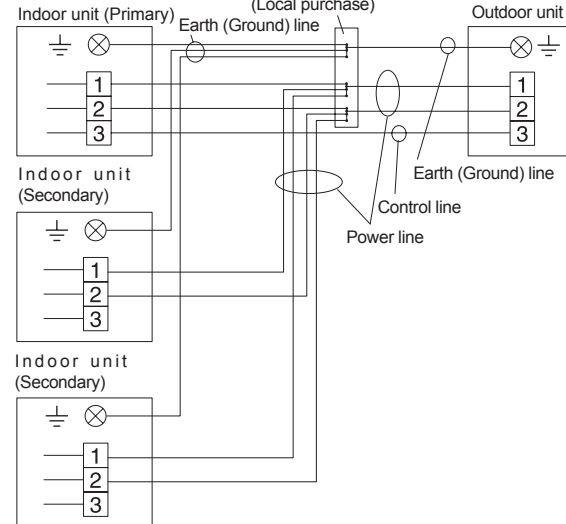

#### Wired remote controller cable

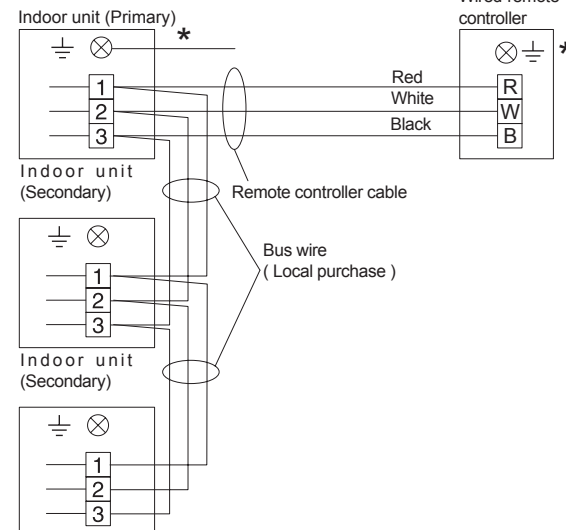

\*Earth (Ground) the remote controller if it has a earth (ground) line.

• Connect the remote controller wires to the primary unit.  
Wired remote controller is recommended using simultaneous twin or triple connection.

**CAUTION**

Tighten the indoor unit connection cable and power supply indoor and outdoor unit, branch box terminal board connections firmly with the terminal board screws. Faulty connection may cause a fire.

If the indoor unit connection cable and power supply are wired incorrectly, the air conditioner may be damaged.

Connect the indoor unit connection cable by matching the numbers of the outdoor, branch box and indoor units terminal board numbers as shown in terminal label.

Earth (Ground) both the indoor and outdoor, branch box units by attaching an earth (a ground) cable.

Unit shall be earthed (grounded) in compliance with the applicable local and national cables.

**CAUTION**

Be sure to refer to the above diagram for do correct field wiring. Wrong wiring causes malfunction of the unit.

Check local electrical rules and also any specific wiring instructions or limitation.

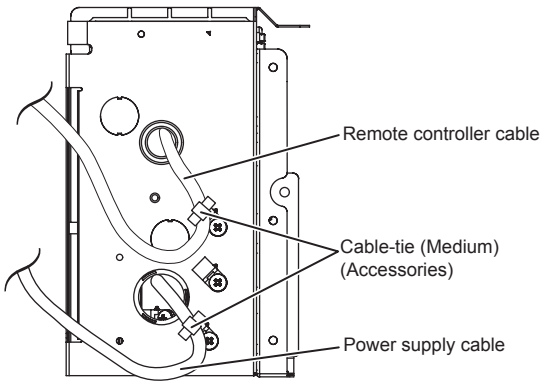

**7. REMOTE CONTROLLER SETTING**

**CAUTION**

When detecting the room temperature using the remote controller, please set up the remote controller according to the following conditions. If the remote controller is not located properly, the correct room temperature will not be detected, and thus abnormal conditions like "not cooled" or "not heated" will occur even if the air-conditioner is running normally.

- Locate where an average temperature for the room being air conditioned will be sensed.
- Do not locate directly exposed to the outlet air from the air-conditioner.
- Locate out of direct sunlight.
- Locate away from the influence of other heat sources.

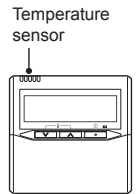

Do not touch the remote controller PC board and PC board parts directly with your hands.

Do not wire the remote controller cable together with or parallel to the connection cables, and power supply cable of the INDOOR UNIT and OUTDOOR UNIT, BRANCH BOX. It may cause erroneous operation.

When installing the bus wire near a source of electromagnetic waves, use shielded wire.

Do not set the DIP switches, either on the air conditioner or the remote controller, in any way other than indicated in this manual that is supplied with the air conditioner. Doing so may result in improper operation.

**6.2. Connection cable preparation**

Keep the earth (ground) wire longer than the other wires.

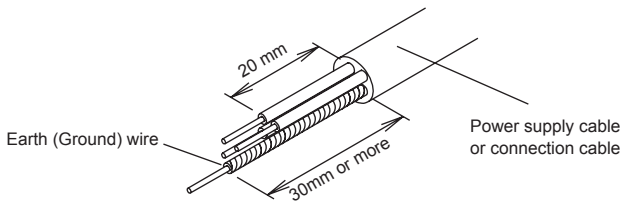

- Use a 4-core wire cable.

**6.3. Connection of wiring**

(1) Remove the control box cover from the control box.

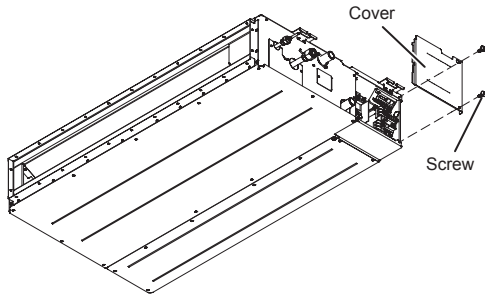

(2) Cable connection

- Connect the connection cable to the terminal board.
- Connect the remote controller cable to the terminal board.
- Fix the remote controller cable to the control box cover with a nylon clamp.

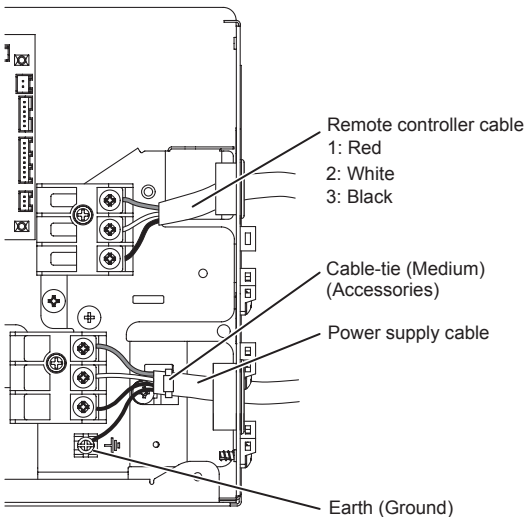

**7.1. Installing the remote controller**

Open the operation panel on the front of the remote controller, remove the 2 screws indicated in the following figure, and then remove the front case of the remote controller.

When installing the remote controller, remove the connector from the front case. The wires may break if the connector is not removed and the front case hangs down. When installing the front case, connect the connector to the front case.

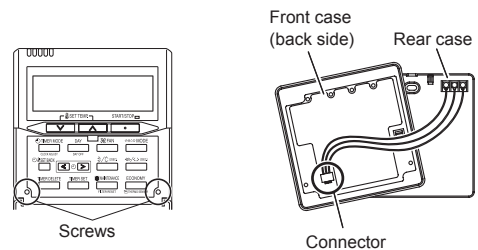

When remote controller cable is concealed

- (1) Conceal the remote controller cable.
- (2) Pass the remote controller cable through the hole in the rear case and connect the remote controller cable to the remote controller terminal board specified in figure.
- (3) Clamp the remote controller cable sheath with the cable-tie as shown in figure.
- (4) Cut off the excess cable-tie.
- (5) Install the rear case to the wall, box, etc., with 2 screws figure.

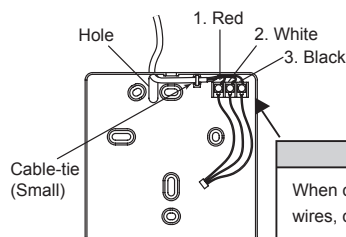

**CAUTION**

When connecting the remote controller wires, do not overtighten the screws.

[Example]

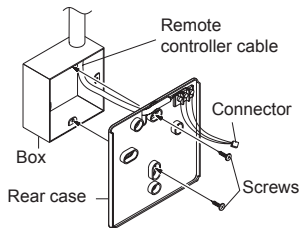

Earth (Ground) the remote controller if it has an earth (a ground) wire.

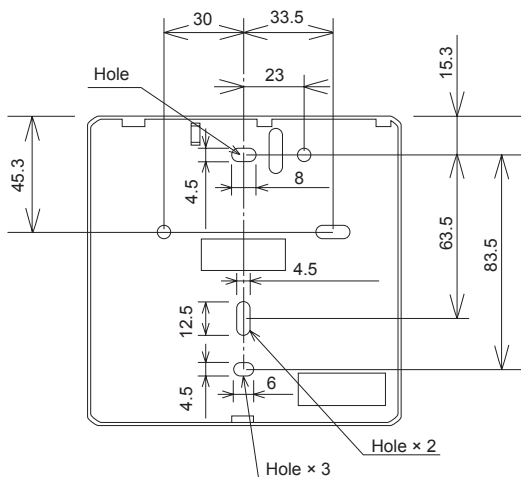
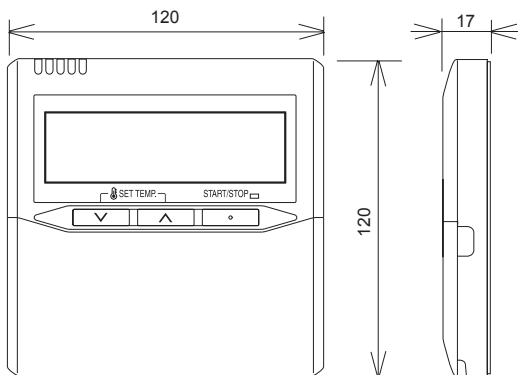
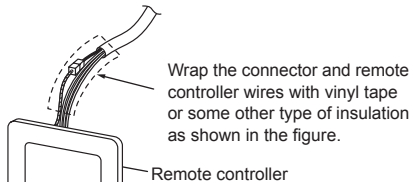

Unit: mm

**CAUTION**

Install the remote controller wires so as not to be direct touched with your hand.  
Do not touch the remote controller PC board and PC board parts directly with your hands.

**7.2. Setting the dip switches**

Set the remote controller DIP switches.

[Example]

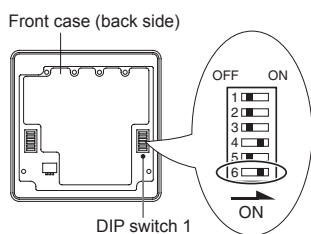

|              | NO. | SW state    |          | Detail  |
|--------------|-----|-------------|----------|---|
|              |     | OFF         | ON       |   |
| DIP-switch 1 | 1   | ★           |          | Cannot be used. (Do not change)   |
|              | 2   | ★           |          | Dual remote controller setting<br>* Refer to 2. DUAL REMOTE CONTROLLERS in 7.5. Special Installation Methods.   |
|              | 3   | ★           |          | Cannot be used. (Do not change)   |
|              | 4   | ★           |          | Cannot be used. (Do not change)   |
|              | 5   | ★           |          | Cannot be used. (Do not change)   |
|              | 6   | ★Invalidity | Validity | Memory backup setting<br>* Set to ON to use batteries for the memory backup. If batteries are not used, all of the settings stored in memory will be deleted if there is a power failure. |

(★ Factory setting)

**7.3. Function setting**

This procedure changes the function settings used to control the indoor unit according to the installation conditions. Incorrect settings can cause the indoor unit to malfunction. This procedure should be performed by authorized installation or service personnel only. Perform the "FUNCTION SETTING" according to the installation conditions using the remote controller. (Refer to the indoor unit installation manual for details on the function numbers and setting values.)

- Press the SET TEMP. buttons (V)(^) and FAN button simultaneously for more than 5 seconds to enter the function setting mode.

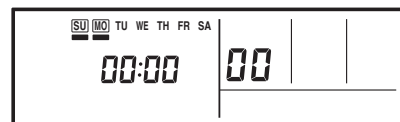
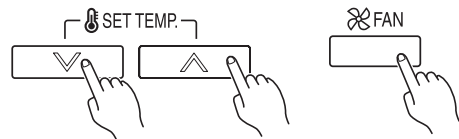

- Press the SET BACK button to select the indoor R.C. address.

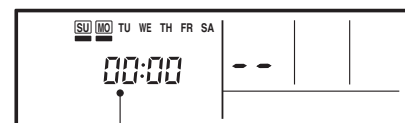

R.C. address of INDOOR UNIT

- Press the SET TIME (< >) buttons to select the function number.

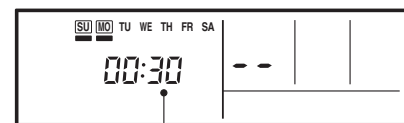
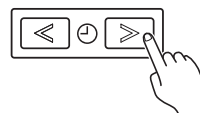

Function number

- (4) Press the SET TEMP. buttons (V) (Λ) to select the setting value. The display flashes as shown to the right during setting value selection.

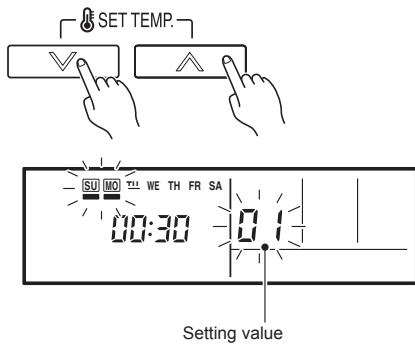

- (5) Press the TIMER SET button to confirm the setting. Press the TIMER SET button for a few seconds until the setting value stops flashing. If the setting value display changes or "--" is displayed when the flashing stops, the setting value has not been set correctly. (An invalid setting value may have been selected for the indoor unit.)
- (6) Repeat steps 2 to 5 to perform additional settings. Press the SET TEMP. buttons (V) (Λ) and FAN button simultaneously again for more than 5 seconds to cancel the function setting mode. In addition, the function setting mode will be automatically canceled after 1 minute if no operation is performed.
- (7) After completing the FUNCTION SETTING, be sure to turn off the power and turn it on again.

## • Function Details

### (1) Filter Sign

The indoor unit has a sign to inform the user that it is time to clean the filter. Select the time setting for the filter sign display interval in the table below according to the amount of dust or debris in the room. If you do not wish the filter sign to be displayed, select the setting value for "No indication".

(♣... Factory setting)

| Setting description        | Function number | Setting value |
|----------------------------|-----------------|---------------|
| Standard (400 hours)       | 11              | 00            |
| Long interval (1000 hours) |                 | 01            |
| Short interval (200 hours) |                 | 02            |
| ♣ No indication            |                 | 03            |

### (2) Static pressure

Select appropriate static pressure according to the installation conditions.

(♣... Factory setting)

| Setting description | Function number | Setting value |
|---------------------|-----------------|---------------|
| 0 Pa                | 26              | 00            |
| 10 Pa               |                 | 01            |
| 20 Pa               |                 | 02            |
| 30 Pa               |                 | 03            |
| 40 Pa               |                 | 04            |
| 50 Pa               |                 | 05            |
| 60 Pa               |                 | 06            |
| 70 Pa               |                 | 07            |
| 80 Pa               |                 | 08            |
| 90 Pa               |                 | 09            |
| ♣ 25 Pa [Standard]  |                 | 31            |

Range of static pressure is different from 1 model to other.

|                          |            |
|--------------------------|------------|
| Range of static pressure | 0 to 90 Pa |
|--------------------------|------------|

### (3) Cooling room temperature correction

Depending on the installed environment, the room temperature sensor may require a correction.

The settings may be selected as shown in the table below.

(♣... Factory setting)

| Setting description    | Function number | Setting value |
|------------------------|-----------------|---------------|
| ♣ Standard             | 30              | 00            |
| Slightly lower control |                 | 01            |
| Lower control          |                 | 02            |
| Warmer control         |                 | 03            |

When using floor console installation, change the setting value to "01".

### (4) Heating room temperature correction

Depending on the installed environment, the room temperature sensor may require a correction.

The settings may be changed as shown in the table below.

(♣... Factory setting)

| Setting description     | Function number | Setting value |
|-------------------------|-----------------|---------------|
| ♣ Standard              | 31              | 00            |
| Lower control           |                 | 01            |
| Slightly warmer control |                 | 02            |
| Warmer control          |                 | 03            |

When using floor console installation, change the setting value to "01".

### (5) Auto restart

Enable or disable automatic system restart after a power outage.

(♣... Factory setting)

| Setting description | Function number | Setting value |
|---------------------|-----------------|---------------|
| ♣ Yes               | 40              | 00            |
| No                  |                 | 01            |

\* Auto restart is an emergency function such as for power failure etc. Do not start and stop the indoor unit by this function in normal operation. Be sure to operate by the control unit, or external input device.

### (6) Indoor room temperature sensor switching function

(Only for Wired remote controller)

The following settings are needed when using the Wired remote controller temperature sensor.

(♣... Factory setting)

| Setting description | Function number | Setting value |
|---------------------|-----------------|---------------|
| ♣ No                | 42              | 00            |
| Yes                 |                 | 01            |

\* If setting value is "00":

Room temperature is controlled by the indoor unit temperature sensor.

\* If setting value is "01":

Room temperature is controlled by either indoor unit temperature sensor or remote controller unit sensor.

### (7) Wireless remote controller signal code

Change the indoor unit Signal Code, depending on the wireless remote controllers.

(♣... Factory setting)

| Setting description | Function number | Setting value |
|---------------------|-----------------|---------------|
| ♣ A                 | 44              | 00            |
| B                   |                 | 01            |
| C                   |                 | 02            |
| D                   |                 | 03            |

### (8) External input control

"Operation/Stop" mode or "Forced stop" mode can be selected.

(♣... Factory setting)

| Setting description   | Function number | Setting value |
|-----------------------|-----------------|---------------|
| ♣ Operation/Stop mode | 46              | 00            |
| (Setting forbidden)   |                 | 01            |
| Forced stop mode      |                 | 02            |

## Setting record

- Record any changes to the settings in the following table.

| Setting   | Setting Value |
|---|---------------|
| (1) Filter sign                                       |               |
| (2) Static pressure                                   |               |
| (3) Cooling room temperature correction               |               |
| (4) Heating room temperature correction               |               |
| (5) Auto restart                                      |               |
| (6) Indoor room temperature sensor switching function |               |
| (7) Wireless remote controller signal code            |               |
| (8) External input control                            |               |

After completing the FUNCTION SETTING, be sure to turn off the power and turn it on again.

## SETTING THE ROOM TEMPERATURE DETECTION LOCATION

The detection location of the room temperature can be selected from the following 2 examples. Choose the detection location that is best for the installation location.

### A. Indoor unit setting (factory setting)

The room temperature is detected by the indoor unit temperature sensor.

- When the THERMO SENSOR button is pressed, the lock display flashes because the function is locked at the factory.

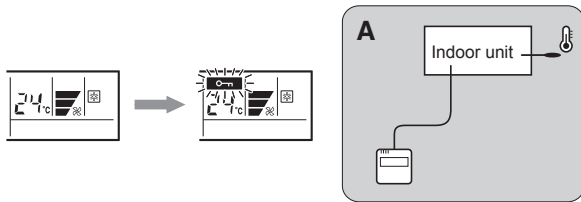

### B. Indoor unit/remote controller setting (room temperature sensor selection)

The temperature sensor of the indoor unit or the remote controller can be used to detect the room temperature.

- Enable the room temperature sensor selection in FUNCTION SETTING, which will be previous page.
- Press the THERMO SENSOR button for 5 seconds or more to select the temperature sensor of the indoor unit or the remote controller.

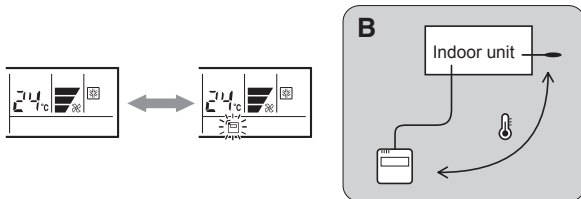

#### NOTES

If the function to change the temperature sensor is used as shown in examples A (other than example B), be sure to lock the detection location. If the function is locked, the lock display  will flash when the THERMO SENSOR button is pressed.

## 7.4. Jumper wire setting

### (1) Drainage function setting (JM1)

If contained drain pump is not used, set the drainage function to "Invalid" in the drainage function switching.

- If contained drain pump is not use:  
When used under "WALL MOUNTED TYPE/FLOOR STANDING CONCEALED TYPE".  
When used in natural drainage under "CEILING CONCEALED TYPE".

(... Factory setting)

| JM1        | Drainage function |
|------------|-------------------|
| ◆ Connect  | Valid             |
| Disconnect | Invalid           |

### (2) Auto louver grille setting (JM2) (Optional parts)

(... Factory setting)

| JM2        | Auto louver grille setting |
|------------|----------------------------|
| ◆ Connect  | Invalid                    |
| Disconnect | Valid                      |

### (3) Fan delay setting (JM3)

It is a function to delay the stop of cooling fan when the air conditioner is stopped.

(... Factory setting)

| JM3        | Fan delay |
|------------|-----------|
| ◆ Connect  | Invalid   |
| Disconnect | Valid     |

#### • Switching position

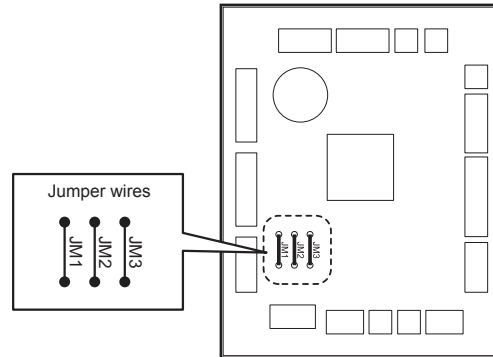

## 7.5. Special installation methods

### CAUTION

When setting DIP switches, do not touch any other parts on the circuit board directly with your bare hands.

Be sure to turn off the main power.

### 7.5.1. Simultaneous multi-system operation

- By combining with an outdoor unit, 2 units for twin and 3 units for triple indoor units, can be switched ON/OFF simultaneously.

#### (1) Wiring method

- Refer to 6.ELECTRICAL WIRING for wiring procedure and wiring method.
- The indoor unit is connected the outdoor unit using a transmission cable is "primary".
- Connect the remote controller wire to the primary unit.

#### Twin type ( 18, 22, 24 type only )

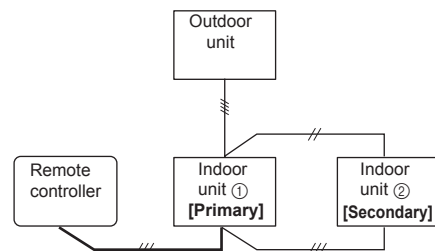

#### Triple type ( 18type only )

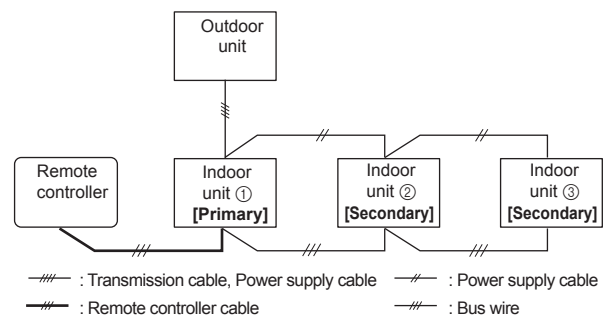



(2) Set the R.C. address (DIP switch setting)

Set the R.C. address of each indoor unit using the DIP switches on the indoor unit circuit board. (See the following table and figure.)

The DIP switches are normally set to make the R.C. address 00.

| Indoor unit | R.C. address | DIP SWITCH No. |     |     |     |
|-------------|--------------|----------------|-----|-----|-----|
|             |              | 1              | 2   | 3   | 4   |
| ①           | 00           | OFF            | OFF | OFF | OFF |
| ②           | 01           | ON             | OFF | OFF | OFF |
| ③           | 02           | OFF            | ON  | OFF | OFF |

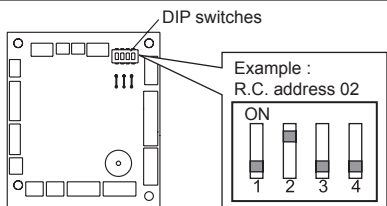

Circuit board in the control box of indoor unit.

**NOTE**

Be sure to set the R.C. address sequentially.

(3) Set the primary and secondary (Remote controller setting)

1. Turn on all of the indoor units.

2. Set the "primary" and "secondary" settings.

(Set the indoor unit that is connected to the outdoor unit using a transmission cable as the "primary".)

|           | Function Number | Setting Value |
|-----------|-----------------|---------------|
| Primary   | 51              | 00            |
| Secondary |                 | 01            |

3. After completing the function settings, turn off all of the indoor units, and then turn them back on.

\* If error code 21, 22, 24 or 27 is displayed, there may be an incorrect setting. Perform the remote controller setting again.

**Twin type ( 18, 22, 24 type only )**

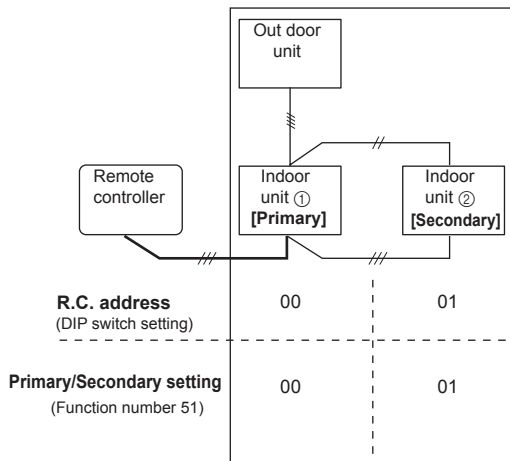

**Triple type ( 18 type only )**

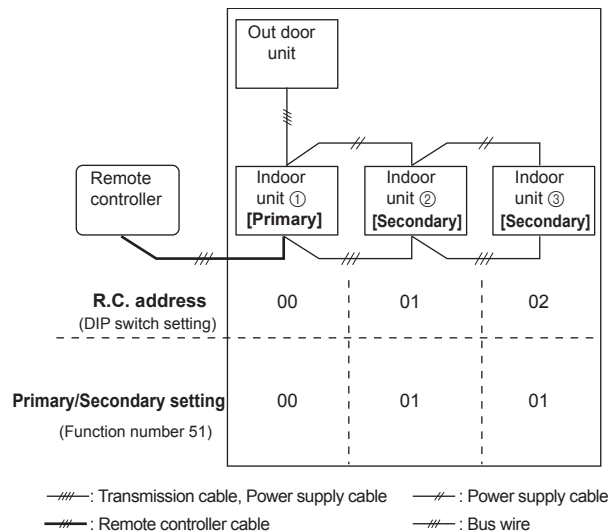

**7.5.2. Group control system**

**CAUTION**

Group control cannot be used when using it by the flexible multi type.

A number of indoor units can be operated at the same time using a single remote controller.

(1) Wiring method (indoor unit to remote controller)

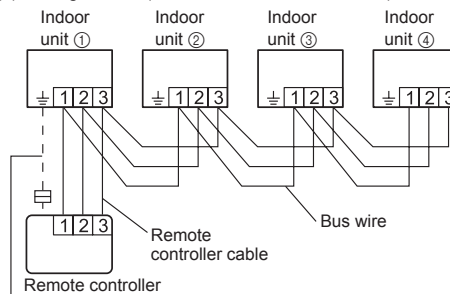

When earth (ground) wire is necessary

(2) Set the R.C. address (DIP switch setting)

Set the R.C. address of each indoor unit using the DIP switches on the indoor unit circuit board. (See the following table and figure.)

The DIP switches are normally set to make the R.C. address 00.

| Indoor unit | R.C. address | DIP SWITCH No. |     |     |     |
|-------------|--------------|----------------|-----|-----|-----|
|             |              | 1              | 2   | 3   | 4   |
| ①           | 00           | OFF            | OFF | OFF | OFF |
| ②           | 01           | ON             | OFF | OFF | OFF |
| ③           | 02           | OFF            | ON  | OFF | OFF |
| ④           | 03           | ON             | ON  | OFF | OFF |
| ⑤           | 04           | OFF            | OFF | ON  | OFF |
| ⑥           | 05           | ON             | OFF | ON  | OFF |
| ⑦           | 06           | OFF            | ON  | ON  | OFF |
| ⑧           | 07           | ON             | ON  | ON  | OFF |
| ⑨           | 08           | OFF            | OFF | OFF | ON  |
| ⑩           | 09           | ON             | OFF | OFF | ON  |
| ⑪           | 10           | OFF            | ON  | OFF | ON  |
| ⑫           | 11           | ON             | ON  | OFF | ON  |
| ⑬           | 12           | OFF            | OFF | ON  | ON  |
| ⑭           | 13           | ON             | OFF | ON  | ON  |
| ⑮           | 14           | OFF            | ON  | ON  | ON  |
| ⑯           | 15           | ON             | ON  | ON  | ON  |

**NOTE**

Be sure to set the R.C. address sequentially.

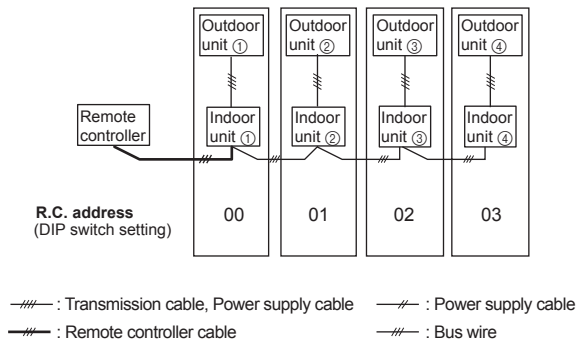

◆ Settings when simultaneous Multi is included

(3) Set the refrigerant circuit address (Remote controller setting)

1. Turn on all of the indoor units.

\* Turn on the indoor unit with the R.C. address 00 last. (Within 1 minute)

2. Set the refrigerant circuit address.

Assign the same number to all of the indoor units connected to an outdoor unit. (The unit is factory-set to "00")

| Refrigerant circuit address | Function Number | Setting Value |
|-----------------------------|-----------------|---------------|
| 00                          | 02              | 00 ~ 15       |
| 01                          |                 |               |
| 14                          |                 |               |
| 15                          |                 |               |

(4) Set the "primary" and "secondary" settings. (Remote controller setting)

(Set the indoor unit that is connected to the outdoor unit using a transmission cable as the "primary".)

|           | Function Number | Setting Value |
|-----------|-----------------|---------------|
| Primary   | 51              | 00            |
| Secondary |                 | 01            |

After completing the function settings, turn off all of the indoor units, and then turn them back on.

\* If error code 21, 22, 24, or 27 is displayed, there may be an incorrect setting. Perform the remote controller setting again.

**NOTE**

- When different indoor unit models are connected using the group control system, some functions may no longer be available.
- If the group control system contains multiple units that are operated simultaneously, connect and set the units as shown below.
- Auto-changeover operates under the same mode with model R.C. address 00.
- It should not be connected to any other Gr that is not of the same series (A\*\*G only).

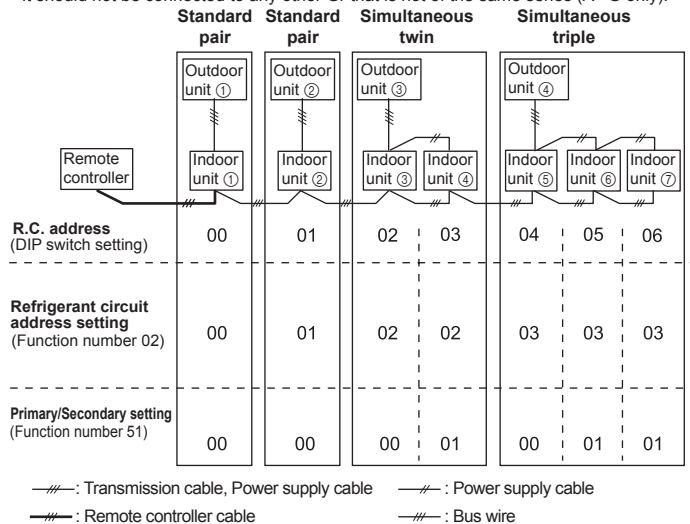

**7.5.3. Dual remote controllers**

- 2 separate remote controllers can be used to operate the indoor units.
- The timer and self-diagnosis functions cannot be used on the secondary units.

(1) Wiring method (indoor unit to remote controller)

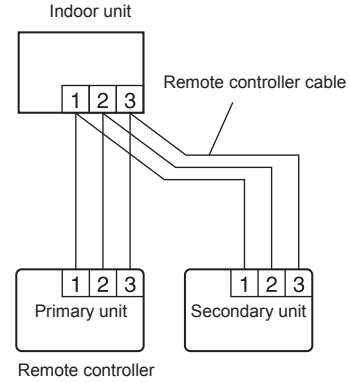

(2) Remote controller DIP switch 1 setting

Set the remote controller DIP switch 1 No. 2 according to the following table.

|                | DIP SW 1-No. 2 |
|----------------|----------------|
| Primary unit   | OFF            |
| Secondary unit | ON             |

**8. TEST RUN**

**CAUTION**

Always turn on the power 12 hours prior to the start of the operation in order to ensure compressor protection.

**CHECK ITEMS**

- Is operation of each button on the remote controller normal?
  - Does each lamp light normally?
  - Do not air flow direction louvers operate normally?
  - Is the drain normal?
  - Is there any abnormal noise and vibration during operation?
- Do not operate the air conditioner in test run for a long time.

**[OPERATION METHOD]**

- For the operation method, refer to the operating manual.

- Stop the air conditioner operation.
- Press the MODE button and the FAN button simultaneously for 2 seconds or more to start the test run.

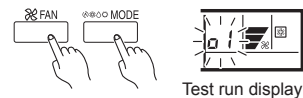

- Press the START / STOP button to stop the test run.

If "C0" appears in the R.C. address display, there is a remote controller error. Refer to the installation manual included with the remote controller.

| R.C. address | Error code | Content   |
|--------------|------------|---|
| C0           | 15         | Incompatible indoor unit is connected               |
| C0           | 12         | Indoor unit ↔ remote controller communication error |

## [Using the wireless remote controller for test run] (Option)

- For the operation method, refer to the operating manual.
- The outdoor unit may not operate depending on the room temperature. In this case, press the TEST RUN button on the wireless remote controller while the air conditioner is running. (Point the transmitter section of the wireless remote controller toward the air conditioner and press the TEST RUN button with the tip of a ball-point pen, etc.)

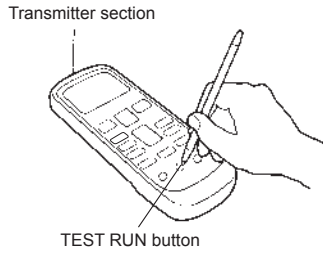

- To end test operation, press the wireless remote controller START/STOP button. (When the air conditioner is run by pressing the TEST RUN button, the OPERATION indicator lamp and TIMER indicator lamp will simultaneously flash slowly.)

## 9. OPTIONAL PARTS

### ⚠ WARNING

Regulation of cable differs from each locality, refer in accordance with local rules.

This air conditioner can be connected with the following optional kits. Refer to each installation manual for the method of installing optional parts.

- Wired remote controller
- Simple remote controller
- External connect kit
- Remote sensor unit
- IR Receiver unit
- Auto louver grille

### 9.1. Wired remote controller (Simple remote controller)

Please refer to [6. ELECTRICAL WIRING] and [7. REMOTE CONTROLLER SETTING].

### 9.2. External input and external output

#### Connection methods

Wire modification:

Use a tool to cut off the terminal on the end of the wire, and then remove the insulation from the cut end of the wire.

Connect the wire with connecting wire with solder.

Important:

Be sure to insulate the connection between the wires.

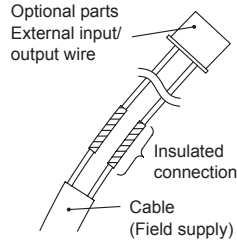

- Connection terminals

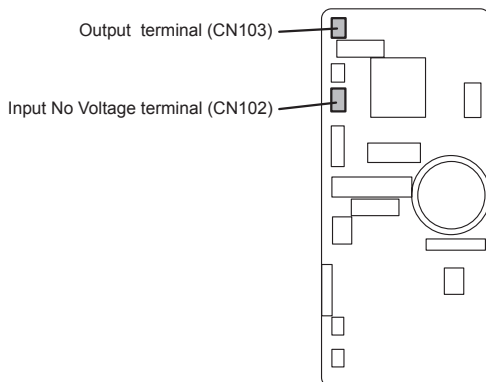

- Wiring arrangement

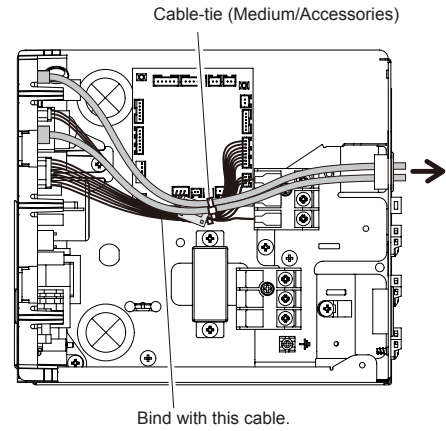

### 9.3. Remote sensor (Optional parts)

#### Connection method

- Connection terminals

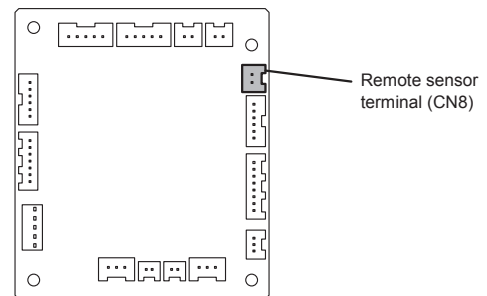

- Wiring arrangement

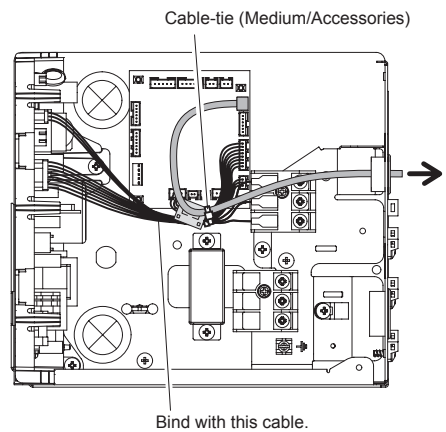

- Remove the existing connector and replace it with the remote sensor connector (ensure that the correct connector is used).
- The original connector should be insulated to ensure that it does not come into contact with other electrical circuitry.

#### Setting for room temperature correction

When a remote sensor is connected, set the function setting of indoor unit as indicated below.

- Set Function Number "30" (Cooling room temperature correction) to "01"
- Set Function Number "31" (Heating room temperature correction) to "01"

## 9.4. IR Receiver Unit (Optional parts)

### Connection method

- Connection terminals

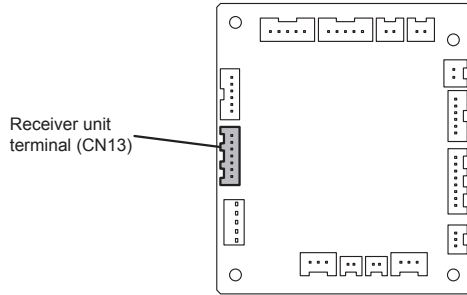

- Wiring arrangement

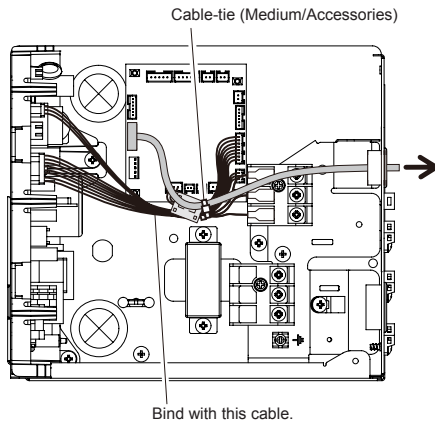

- Use 7 pins for receiver unit cable.
- At first, connect the receiver unit cable to the Receiver unit terminal (CN13).

## 9.5. Auto louver grille (Optional parts)

### Connection method

- Connection terminal and jumper wires

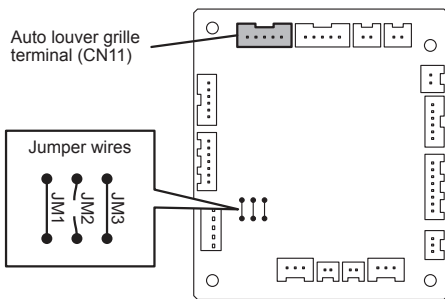

- Cut Jumper wire JM2
- Wiring arrangement

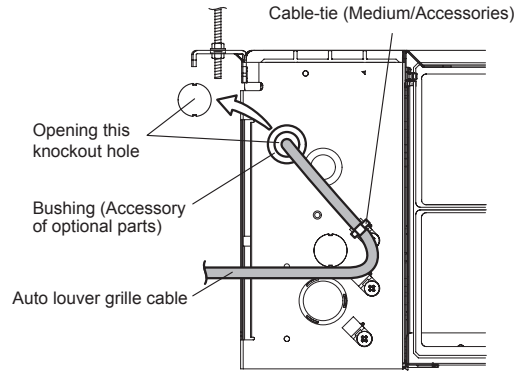
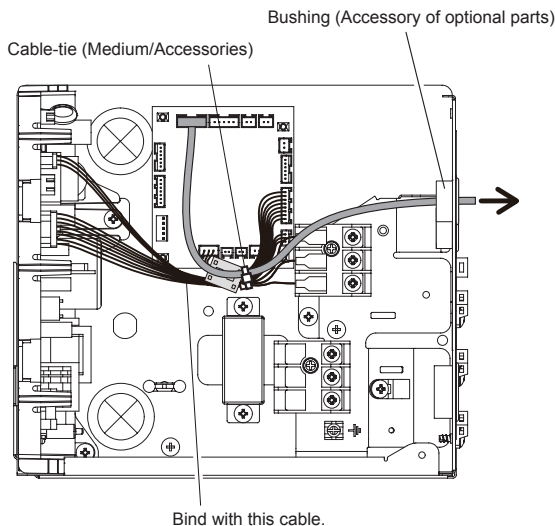

## 9.6. Optional parts cable binding

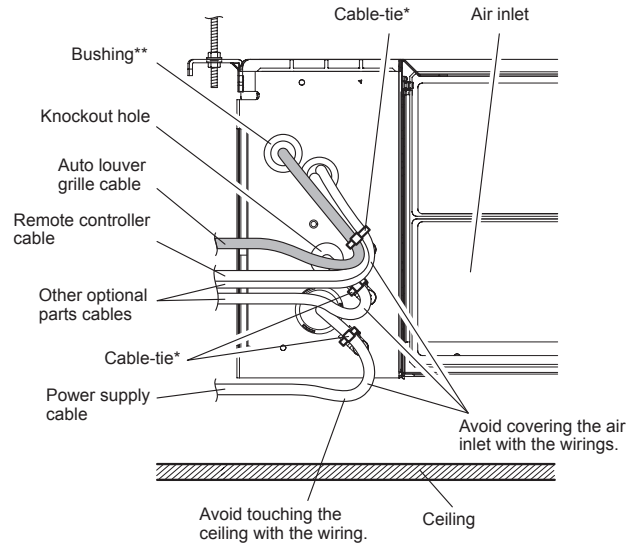

- \* Use an accessory of indoor unit or optional parts for Cable-tie.
- \*\* Use an accessory of optional parts for bushing.

- Do not bind the power supply cable and other cables together.

### CAUTION

To protect the cable insulation after opening a knockout hole, remove any burrs from the edge of the hole.

## 10. CUSTOMER GUIDANCE

Explain the following to the customer in accordance with the operating manual:

- (1) Starting and stopping method, operation switching, temperature adjustment, timer, air flow switching, and other remote controller operations.
  - (2) Air filter removal and cleaning, and how to use the air louvers.
  - (3) Give the operating and installation manuals to the customer.
  - (4) If the signal code is changed, explain to the customer how it changed (the system returns to signal code A when the batteries in the remote controller are replaced).
- \* (4) is applicable to using wireless remote controller.

## 11. ERROR CODES

If you use a wired type remote controller, error codes will appear on the remote controller display. If you use a wireless remote controller, the lamps on the IR receiver unit will output error codes by way of blinking patterns. See the lamp blinking patterns and error codes in the table below. An error display is displayed only during operation.

| OPERATION lamp (green) | Error display       |                      |  | Wired remote controller Error code | Description                                 |
|------------------------|---------------------|----------------------|--|------------------------------------|---|
|                        | TIMER lamp (orange) | ECONOMY lamp (green) |  |                                    |   |
| ●(1)                   | ●(1)                | ◇                    |  | 11                                 | Serial communication error                  |
| ●(1)                   | ●(2)                | ◇                    |  | 12                                 | Wired remote controller communication error |
| ●(1)                   | ●(5)                | ◇                    |  | 15                                 | Check run unfinished                        |

|      |       |   |    |   |
|------|-------|---|----|---|
| ●(2) | ●(1)  | ◇ | 21 | R.C. address or Refrigerant circuit address setting error [Simultaneous Multi]  |
| ●(2) | ●(2)  | ◇ | 22 | Indoor unit capacity error  |
| ●(2) | ●(3)  | ◇ | 23 | Combination error   |
| ●(2) | ●(4)  | ◇ | 24 | • Connection R.C. address error (indoor secondary unit) [Simultaneous Multi]<br>• Connection R.C. address error (indoor unit or branch unit) [Flexible Multi] |
| ●(2) | ●(7)  | ◇ | 27 | Primary unit, secondary unit set-up error [Simultaneous Multi]  |
| ●(3) | ●(1)  | ◇ | 31 | Power supply interruption error   |
| ●(3) | ●(2)  | ◇ | 32 | Indoor unit PCB model information error   |
| ●(3) | ●(5)  | ◇ | 35 | Manual auto switch error  |
| ●(4) | ●(1)  | ◇ | 41 | Room temp. sensor error   |
| ●(4) | ●(2)  | ◇ | 42 | Indoor unit Heat Ex. Middle temp. sensor error  |
| ●(5) | ●(1)  | ◇ | 51 | Indoor unit fan motor error   |
| ●(5) | ●(3)  | ◇ | 53 | Drain pump error  |
| ●(5) | ●(7)  | ◇ | 57 | Damper error  |
| ●(5) | ●(15) | ◇ | 5U | Indoor unit error   |
| ●(6) | ●(2)  | ◇ | 62 | Outdoor unit main PCB model information error or communication error  |
| ●(6) | ●(3)  | ◇ | 63 | Inverter error  |
| ●(6) | ●(4)  | ◇ | 64 | Active filter error, PFC circuit error  |
| ●(6) | ●(5)  | ◇ | 65 | Trip terminal L error   |
| ●(6) | ●(10) | ◇ | 6A | Display PCB microcomputers communication error  |
| ●(7) | ●(1)  | ◇ | 71 | Discharge temp. sensor error  |
| ●(7) | ●(2)  | ◇ | 72 | Compressor temp. sensor error   |
| ●(7) | ●(3)  | ◇ | 73 | Outdoor unit Heat Ex. liquid temp. sensor error   |
| ●(7) | ●(4)  | ◇ | 74 | Outdoor temp. sensor error  |
| ●(7) | ●(5)  | ◇ | 75 | Suction Gas temp. sensor error  |
| ●(7) | ●(6)  | ◇ | 76 | • 2-way valve temp. sensor error<br>• 3-way valve temp. sensor error  |
| ●(7) | ●(7)  | ◇ | 77 | Heat sink temp. sensor error  |
| ●(8) | ●(2)  | ◇ | 82 | • Sub-cool Heat Ex. gas inlet temp. sensor error<br>• Sub-cool Heat Ex. gas outlet temp. sensor error   |
| ●(8) | ●(3)  | ◇ | 83 | Liquid pipe temp. sensor error  |
| ●(8) | ●(4)  | ◇ | 84 | Current sensor error  |
| ●(8) | ●(6)  | ◇ | 86 | • Discharge pressure sensor error<br>• Suction pressure sensor error<br>• High pressure switch error  |
| ●(9) | ●(4)  | ◇ | 94 | Trip detection  |
| ●(9) | ●(5)  | ◇ | 95 | Compressor rotor position detection error (permanent stop)  |
| ●(9) | ●(7)  | ◇ | 97 | Outdoor unit fan motor 1 error  |
| ●(9) | ●(8)  | ◇ | 98 | Outdoor unit fan motor 2 error  |

|       |       |   |    |                                     |
|-------|-------|---|----|-------------------------------------|
| ●(9)  | ●(9)  | ◇ | 99 | 4-way valve error                   |
| ●(9)  | ●(10) | ◇ | 9A | Coil (expansion valve ) error       |
| ●(10) | ●(1)  | ◇ | A1 | Discharge temp. error               |
| ●(10) | ●(3)  | ◇ | A3 | Compressor temp. error              |
| ●(10) | ●(4)  | ◇ | A4 | High pressure error                 |
| ●(10) | ●(5)  | ◇ | A5 | Low pressure error                  |
| ●(13) | ●(2)  | ◇ | J2 | Branch boxes error [Flexible Multi] |

Display mode ● : 0.5s ON / 0.5s OFF

◇ : 0.1s ON / 0.1s OFF

( ) : Number of flashing

## [Troubleshooting at the remote controller LCD]

This is possible only on the wired remote controller.

### [Self-diagnosis]

If an error occurs, the following display will be shown. ("Er" will appear in the set room temperature display.)

