

AIR CONDITIONER

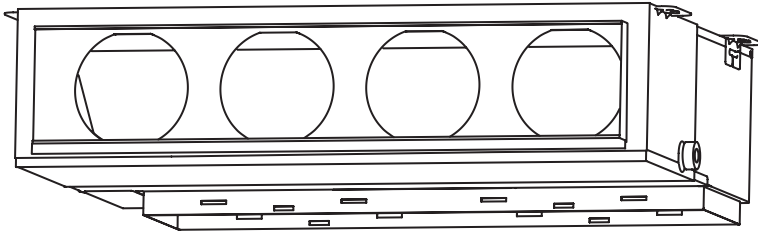

INSTALLATION MANUAL

For authorized service personnel only.

English

INSTALLATIONSANLEITUNG

Nur für autorisiertes Personal.

Deutsch

MANUEL D'INSTALLATION

Pour le personnel agréé uniquement.

Français

MANUAL DE INSTALACIÓN

Solo para personal autorizado.

Español

MANUALE D'INSTALLAZIONE

Ad uso esclusivo del personale autorizzato.

Italiano

ΕΓΧΕΙΡΙΔΙΟ ΕΓΚΑΤΑΣΤΑΣΗΣ

Για εξουσιοδοτημένο προσωπικό σέρβις.

Ελληνικά

MANUAL DE INSTALAÇÃO

Apenas para técnicos autorizados.

Português

РУКОВОДСТВО ПО УСТАНОВКЕ

Для уполномоченного персонала.

Русский

KURULUM KILAVUZU

Yetkili servis personeli içindir.

Türkçe

INSTALLATION MANUAL

PART NO. 9379127035
INDOOR UNIT (Duct Type)

Contents

1. SAFETY PRECAUTIONS.....	1
2. ABOUT THE UNIT.....	1
2.1. Precautions for using the R410A refrigerant.....	1
2.2. Special tool for R410A.....	1
2.3. Accessories.....	2
2.4. Optional parts.....	2
3. INSTALLATION WORK.....	2
3.1. Selecting an installation location.....	2
3.2. Installation dimension.....	3
3.3. Installation the unit.....	3
4. PIPE INSTALLATION.....	4
4.1. Selecting the pipe material.....	4
4.2. Pipe requirement.....	5
4.3. Flare connection (Pipe connection).....	5
4.4. Installing heat insulation.....	6
5. INSTALLING DRAIN HOSE.....	6
6. ELECTRICAL WIRING.....	7
6.1. Wiring system diagram.....	7
6.2. Connection cable preparation.....	8
6.3. Connection of wiring.....	8
7. REMOTE CONTROLLER SETTING.....	9
7.1. Installing the remote controller.....	9
7.2. Setting the DIP switches.....	9
8. FUNCTION SETTING.....	10
8.1. Turning on the power.....	10
8.2. Function setting.....	10
8.3. Static pressure characteristic.....	12
8.4. Special installation methods.....	12
9. FRESH AIR INTAKE.....	13
10. TEST RUN.....	14
11. CHECK LIST.....	14
12. OPTIONAL KIT INSTALLATION (OPTION).....	14
13. CUSTOMER GUIDANCE.....	15
14. ERROR CODES.....	15

1. SAFETY PRECAUTIONS

- Be sure to read this Manual thoroughly before installation.
- The warnings and precautions indicated in this Manual contain important information pertaining to your safety. Be sure to observe them.
- Hand this Manual, together with the Operating Manual to the customer. Request the customer to keep them on hand for future use, such as for relocating or repairing the unit.

WARNING

This mark indicates procedures which, if improperly performed, might lead to the death or serious injury of the user.

CAUTION

This mark indicates procedures which, if improperly performed, might possibly result in personal harm to the user, or damage to property.

WARNING

Request your dealer or a professional installer to install the indoor unit in accordance with this Installation Manual. An improperly installed unit can cause serious accidents such as water leakage, electric shock, or fire. If the indoor unit is installed in disregard of the instructions in the Installation Manual, it will void the manufacturer's warranty.

Do not turn ON the power until all work has been completed. Turning ON the power before the work is completed can cause serious accidents such as electric shock or fire.

If refrigerant leaks while work is being carried out, ventilate the area. If the refrigerant comes in contact with a flame, it produces a toxic gas.

Installation work must be performed in accordance with national wiring standards by authorized personnel only.

Except for EMERGENCY, never turn off main as well as sub breaker of the indoor units during operation. It will cause compressor failure as well as water leakage. First, stop the indoor unit by operating the control unit, converter or external input device and then cut the breaker.

Make sure to operate through the control unit, converter or external input device. When the breaker is designed, locate it at a place where the users cannot start and stop in the daily work.

CAUTION

Read carefully all security information before use or install the air conditioner.

Do not attempt to install the air conditioner or a part of the air conditioner by yourself.

This unit must be installed by qualified personnel with a capacity certificate for handling refrigerant fluids. Refer to regulation and laws in use on installation place.

The installation must be carried out in compliance with regulations in force in the place of installation and the installation instructions of the manufacturer.

This unit is part of a set constituting an air conditioner. It must not be installed alone or with non-authorized by the manufacturer.

Always use a separate power supply line protected by a circuit breaker operating on all wires with a distance between contact of 3mm for this unit.

The unit must be correctly grounded and the supply line must be equipped with a differential breaker in order to protect the persons.

The units are not explosion proof and therefore should not be installed in explosive atmosphere.

Never touch electrical components immediately after the power supply has been turned off. Electric shock may occur. After turning off the power, always wait 5 minutes before touching electrical components.

This unit contains no user-serviceable parts. Always consult authorized service personnel to repairs.

When moving, consult authorized service personnel for disconnection and installation of the unit.

This appliance is not intended for use by persons (including children) with reduced physical, sensory or mental capabilities, or lack of experience and knowledge, unless they have been given supervision or instruction concerning use of the appliance by a person responsible for their safety. Children should be supervised to ensure that they do not play with the appliance.

2. ABOUT THE UNIT

2.1. Precautions for using the R410A refrigerant

WARNING

Do not introduce any substance other than the prescribed refrigerant into the refrigeration cycle. If air enters the refrigeration cycle, the pressure in the refrigeration cycle will become abnormally high and cause the piping to rupture.

If there is a refrigerant leakage, make sure that it does not exceed the concentration limit. If a refrigerant leakage exceeds the concentration limit, it can lead to accidents such as oxygen starvation.

Do not touch refrigerant that has leaked from the refrigerant pipe connections or other area. Touching the refrigerant directly can cause frostbite.

If a refrigerant leakage occurs during operation, immediately vacate the premises and thoroughly ventilate the area. If the refrigerant comes in contact with a flame, it produces a toxic gas.

2.2. Special tool for R410A

WARNING

To install a unit that uses the R410A refrigerant, use dedicated tools and piping materials that have been manufactured specifically for R410A use. Because the pressure of the R410A refrigerant is approximately 1.6 times higher than the R22, failure to use dedicated piping material or improper installation can cause rupture or injury. Furthermore, it can cause serious accidents such as water leakage, electric shock, or fire.

Tool name	Contents of change
Gauge manifold	Pressure is huge and cannot be measured with a conventional gauge. To prevent erroneous mixing of other refrigerants, the diameter of each port has been changed. It is recommended to use a gauge manifold with a high pressure display range -0.1 to 5.3 MPa and a low pressure display range -0.1 to 3.8 MPa.
Charging hose	To increase pressure resistance, the hose material and base size were changed.
Vacuum pump	A conventional vacuum pump can be used by installing a vacuum pump adapter.
Gas leakage detector	Special gas leakage detector for HFC refrigerant R410A.

2.3. Accessories











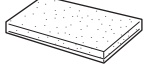

⚠ WARNING

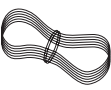

For installation purposes, be sure to use the parts supplied by the manufacturer or other prescribed parts.
The use of non-prescribed parts can cause serious accidents such as the unit to fall, water leakage, electric shock, or fire.

The following installation parts are furnished. Use them as required.

Keep the Installation Manual in a safe place and do not discard any other accessories until the installation work has been completed.

Do not discard any accessories needed for installation until the installation work has been completed.

Name and Shape	Q'ty	Description
Operating manual 	1	
Installation manual 	1	(This book)
Hanger 	4	For suspending the indoor unit from ceiling
Drain hose insulation 	1	Insulates the drain hose and vinyl hose
Cable tie (large) 	1	For fixing the drain hose
Cable tie (small) 	1	For remote controller and remote controller cable binding
Cable tie 	2	For electrical wiring (22,24 model)
Wire clammer 	1	For electrical wiring (22,24 model)
Remote controller 	1	For air conditioner operation
Remote controller cable (*1) 	1	For connecting the remote controller
Screw (M4 × 16) 	2	For installing the remote controller
Coupler heat insulation (large) 	1	For indoor side pipe joint (gas)
Coupler heat insulation (small) 	1	For indoor side pipe joint (liquid)

Special nut A (large flange) 	4	For suspending the indoor unit from ceiling
Special nut B (small flange) 	4	For suspending the indoor unit from ceiling

(*1) Not supplied for ART series

2.4. Optional parts

Parts name	Model No.	Application
Wired remote controller	UTY-RNN*M	For air conditioner operation
Wired remote controller	UTY-RVN*M	For air conditioner operation
Simple remote controller	UTY-RSN*M	For air conditioner operation
Remote sensor unit	UTY-XSZX	Room temperature sensor
External connect kit	UTD-ECS5A	For control input/output port
Square flange	UTD-SF045T	
Round flange	UTD-RF204	
Long-life filter	UTD-LF25NA	
Drain pump unit	UTZ-PX1NBA	

3. INSTALLATION WORK

3.1. Selecting an installation location

Especially, the installation place is very important for the split type air conditioner because it is very difficult to move from place to place after the first installation.

⚠ WARNING

Select installation locations that can properly support the weight of the indoor. Install the units securely so that they do not topple or fall.

⚠ CAUTION

Do not install the unit in the following areas:

- Area with high salt content, such as at the seaside.
It will deteriorate metal parts, causing the parts to fail or the unit to leak water.
- Area filled with mineral oil or containing a large amount of splashed oil or steam, such as a kitchen.
It will deteriorate plastic parts, causing the parts to fail or the unit to leak water.
- Area that generates substances that adversely affect the equipment, such as sulfuric gas, chlorine gas, acid, or alkali.
It will cause the copper pipes and brazed joints to corrode, which can cause refrigerant leakage.
- Area that can cause combustible gas to leak, contains suspended carbon fibers or flammable dust, or volatile inflammables such as paint thinner or gasoline.
If gas leaks and settles around the unit, it can cause a fire.
- Area where animals may urinate on the unit or ammonia may be generated.

Do not use the unit for special purposes, such as storing food, raising animals, growing plants, or preserving precision devices or art objects.
It can degrade the quality of the preserved or stored objects.

Do not install where there is the danger of combustible gas leakage.

Do not install the unit near a source of heat, steam, or flammable gas.

Install the unit where drainage does not cause any trouble.

Install the indoor unit, outdoor unit, power supply cable, transmission cable, and remote controller cable at least 1 m away from a television or radio receivers. The purpose of this is to prevent TV reception interference or radio noise.
(Even if they are installed more than 1 m apart, you could still receive noise under some signal conditions.)

Take precautions to prevent the unit from falling.

Decide the mounting position with the customer as follows:

- (1) Install the indoor unit in a location having sufficient strength to support the weight of the indoor unit.
- (2) The inlet and outlet ports should not be obstructed; the air should be able to blow all over the room.

- (3) Leave the space required to service the air conditioner.
- (4) Locate where the air can be distributed evenly throughout the room by the unit.
- (5) Install the unit where connection to the outdoor unit is easy.
- (6) Install the unit where the connection pipe can be easily installed.
- (7) Install the unit where the drain pipe can be easily installed.
- (8) Install the unit where noise and vibration is not amplified.
- (9) Take servicing, etc., into consideration and leave the spaces. Also install the unit where the filter can be removed.
- (10) Providing as much space as possible between the indoor unit and the ceiling will make work much easier.
- (11) If installing in a place where its humidity exceeds 80%, use heat insulation to prevent condensation.

3.2. Installation dimension

Provide the space around the unit as shown in the following figure.

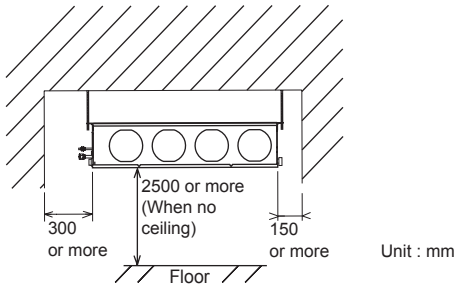

Maintenance hole dimensions:

It shall be possible to install and remove the control box.

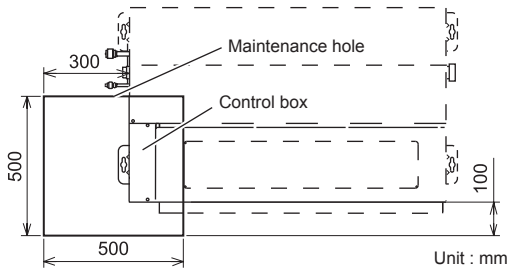

It shall be possible to install and remove the control box, fan units and filter.

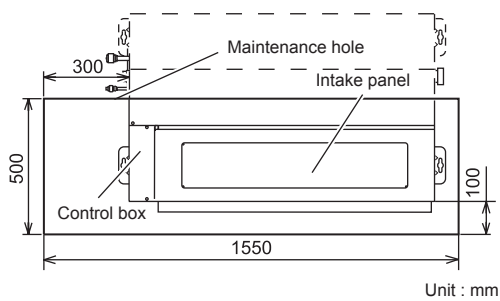

3.3. Installation the unit

WARNING

Install the air conditioner in a location which can withstand a load do at least 5 times the weight of the main unit and which will not amplify sound or vibration. If the installation location is not strong enough, the indoor unit may fall and cause injuries.

If the job is done with the panel frame only, there is a risk that the unit will come loose. Please take care.

3.3.1. Installing the hangers

WARNING

When fastening the hangers, make the bolt positions uniform.

Hanging bolt installation diagram.

(Example)

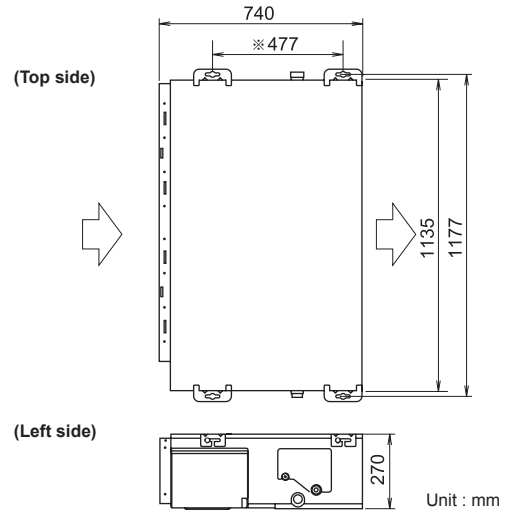

The distance of \approx is adjustable according to the place of the hanging bolts.
(MAX : 550 mm, MIN : 410 mm)

Slide the unit in the arrow direction and fasten it.

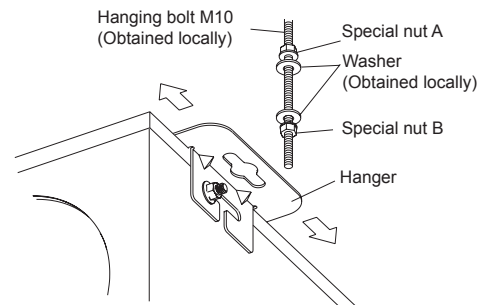

Bolt Strength [N·m (kgf·cm)]

9.81 to 14.71 (100 to 150)

CAUTION

Fasten the unit securely with special nuts A and B.

3.3.2. Leveling

Base vertical direction leveling on the unit (right and left).

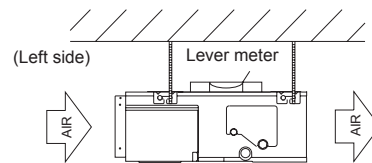

Base horizontal direction leveling on top of the unit.

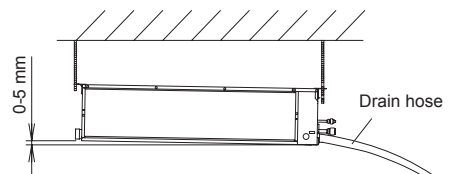

Give a slight tilt to the side to which the drain hose is connected.

The tilt should be in the range of 0 mm to 5 mm.

3.3.3. Intake duct connection

Follow the procedure in the following figure to the ducts.

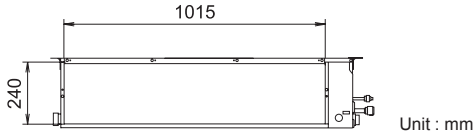

The air inlet duct can be changed by replacing the intake grille and flange.

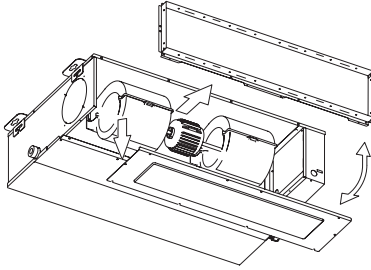

For the bottom air intake, follow the procedure of ①→② for installation. (The factory setting is back air intake.)

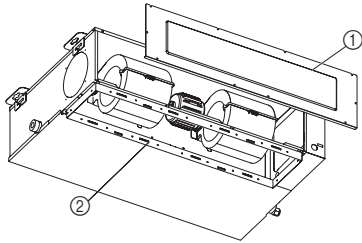

CAUTION

When air is taken in from the bottom side, the operating sound of the product will easily enter the room. Install the product and intake grilles where the affect of the operating sound is small.

CAUTION

If an intake duct is installed, take care not to damage the temperature sensor. Be sure to install the air inlet grille and the air outlet grille for air circulation. The correct temperature cannot be detected.

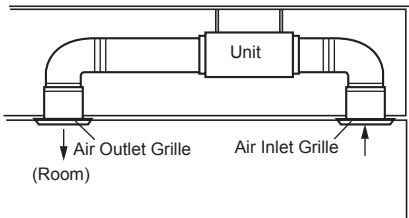

When connecting the duct, perform duct-insulation that is appropriate for the installing environment. Inappropriate insulation work may cause condensation on the surface of the insulating material, and may lead condensation drip.

Grills must be fixed so that man cannot touch indoor unit fan, and cannot be removed by only hand operation without tool.

Be sure to install the air filter in the air inlet. If the air filter is not installed, the heat exchanger may be clogged and its performance may decrease.

3.3.4. Outlet duct connection

Duct installation pattern (CUT PART)

(1) Square duct



(2) Round duct outlet ×4

(This is the factory setting.)



When using as a square duct

(1) Cut the slit seam with a cutter.

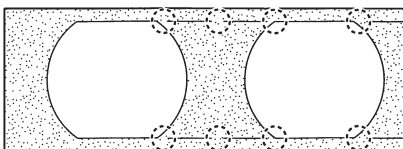

(2) Turn up the insulation around the points to be cut according to the outlet port shape working points so that the insulation does not stick out at the part.

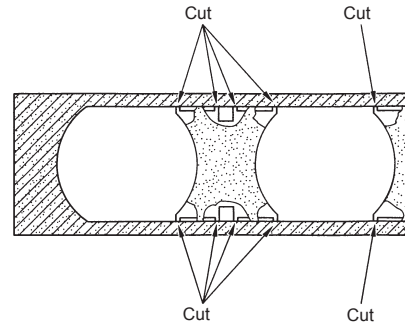

(3) Cut with nippers and remove the sheet metal.

(4) Since there is a slit in the insulation, use radio pliers, tweezers, etc. to stretch the screw hole part used when installing the round flange and square flange when connecting the duct.

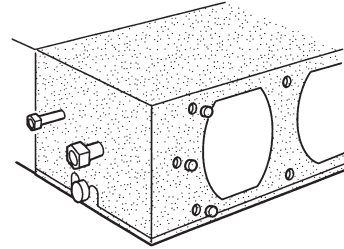

CAUTION

Check that duct work does not exceed the range of external static pressure of equipment.

Make sure to insulate ducts to avoid the dew condensation.

Make sure to insulate between ducts and walls if metal ducts are used.

Please explain handling and washing methods of locally purchased materials to the customer.

To prevent people from touching the parts inside the unit, be sure to install grilles on the inlet and outlet ports. The grilles must be designed in such a way that cannot be removed without tools.

When connecting the duct to the outlet port of the indoor unit, be sure to insulate the outlet port and the installation screws to prevent water from leaking around the port.

4. PIPE INSTALLATION

CAUTION

Be careful that foreign matter (oil, water, etc.) does not enter the piping with refrigerant R410A models. Also, when storing the piping, securely seal the openings by pinching, taping, etc.

While brazing the pipes, be sure to purge with dry nitrogen gas.

4.1. Selecting the pipe material

CAUTION

Do not use existing pipes.

Use pipes that have clean external and internal sides without any contamination which may cause trouble during use, such as sulfur, oxide, dust, cutting waste, oil, or water.

It is necessary to use seamless copper pipes.
Material : Phosphor deoxidized seamless copper pipes
It is desirable that the amount of residual oil is less than 40 mg/10 m.

Do not use copper pipes that have a collapsed, deformed, or discolored portion (especially on the interior surface). Otherwise, the expansion valve or capillary tube may become blocked with contaminants.

Improper pipe selection will degrade performance. As an air conditioner using R410A incurs pressure higher than when using conventional refrigerant, it is necessary to choose adequate materials.

- Thicknesses of copper pipes used with R410A are as shown in the table.
- Never use copper pipes thinner than those indicated in the table even if they are available on the market.

Thicknesses of Annealed Copper Pipes (R410A)

Pipe outside diameter [mm (in.)]	Thickness [mm]
6.35 (1/4)	0.80
9.52 (3/8)	0.80
12.70 (1/2)	0.80
15.88 (5/8)	1.00
19.05 (3/4)	1.20

4.2. Pipe requirement

⚠ CAUTION

Refer to the Installation Manual of the outdoor unit for description of the length of connecting pipe or for difference of its elevation.

Install heat insulation around both the gas and liquid pipes. Failure to do so may cause water leaks.

Use heat insulation with heat resistance above 120 °C. (Reverse cycle model only)
In addition, if the humidity level at the installation location of the refrigerant piping is expected to exceed 70 %, install heat insulation around the refrigerant piping. If the expected humidity level is 70-80 %, use heat insulation that is 15 mm or thicker and if the expected humidity exceeds 80 %, use heat insulation that is 20 mm or thicker. If heat insulation is used that is not as thick as specified, condensation may form on the surface of the insulation. In addition, use heat insulation with heat conductivity of 0.045 W/(m·K) or less (at 20 °C).

Use pipe with water-resistant heat insulation.

4.3. Flare connection (Pipe connection)

⚠ WARNING

Tighten the flare nuts with a torque wrench using the specified tightening method. Otherwise, the flare nuts could break after a prolonged period, causing refrigerant to leak and generate a hazardous gas if the refrigerant comes into contact with a flame.

4.3.1. Flaring

Use special pipe cutter and flare tool exclusive for R410A.

- Cut the connection pipe to the necessary length with a pipe cutter.
- Hold the pipe downward so that cuttings will not enter the pipe and remove any burrs.
- Insert the flare nut (always use the flare nut attached to the indoor and outdoor units respectively) onto the pipe and perform the flare processing with a flare tool. Use the special R410A flare tool, or the conventional flare tool. Leakage of refrigerant may result if other flare nuts are used.
- Protect the pipes by pinching them or with tape to prevent dust, dirt, or water from entering the pipes.

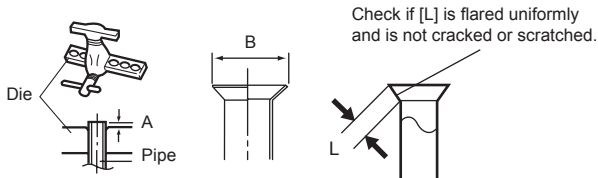

Pipe outside diameter [mm (in.)]	Dimension A [mm]	Dimension B _{0.4} [mm]
	Flare tool for R410A, clutch type	
6.35 (1/4)	0 to 0.5	9.1
9.52 (3/8)		13.2
12.70 (1/2)		16.6
15.88 (5/8)		19.7
19.05 (3/4)		24.0

When using conventional flare tools to flare R410A pipes, the dimension A should be approximately 0.5 mm more than indicated in the table (for flaring with R410A flare tools) to achieve the specified flaring. Use a thickness gauge to measure the dimension A.

Width across flats



Pipe outside diameter [mm (in.)]	Width across flats of Flare nut [mm]
6.35 (1/4)	17
9.52 (3/8)	22
12.70 (1/2)	26
15.88 (5/8)	29
19.05 (3/4)	36

4.3.2. Bending pipes

- If pipes are shaped by hand, be careful not to collapse them.
- Do not bend the pipes in an angle more than 90°.
- When pipes are repeatedly bend or stretched, the material will harden, making it difficult to bend or stretch them any more.
- Do not bend or stretch the pipes more than 3 times.

⚠ CAUTION

To prevent breaking of the pipe, avoid sharp bends.

If the pipe is bent repeatedly at the same place, it will break.

4.3.3. Pipe connection

⚠ CAUTION

Be sure to install the pipe against the port on the indoor unit correctly. If the centering is improper, the flare nut cannot tighten smoothly. If the flare nut is forced to turn, the threads will be damaged.

Do not remove the flare nut from the indoor unit pipe until immediately before connecting the connection pipe.

Do not use mineral oil on flared part. Prevent mineral oil from getting into the system as this would reduce the lifetime of the units.

Be sure to connect the gas pipe after connecting the liquid pipe completely.

- Detach the caps and plugs from the pipes.
- Center the pipe against the port on the indoor unit, and then turn the flare nut by hand.
- When the flare nut is tightened properly by your hand, hold the body side coupling with a separate spanner, then tighten with a torque wrench. (See the table below for the flare nut tightening torques.)

⚠ CAUTION

Hold the torque wrench at its grip, keeping it at a right angle with the pipe, in order to tighten the flare nut correctly.

Tighten the flare nuts with a torque wrench using the specified tightening method. Otherwise, the flare nuts could break after a prolonged period, causing refrigerant to leak and generate a hazardous gas if the refrigerant comes into contact with a flame.

Connect the piping so that the control box cover can easily be removed for servicing when necessary.

In order to prevent water from leaking into the control box, make sure that the piping is well insulated.

When the flare nut is tightened properly by your hand, hold the body side coupling with a separate spanner, then tighten with a torque wrench. (See the table below for the flare nut tightening torques.)

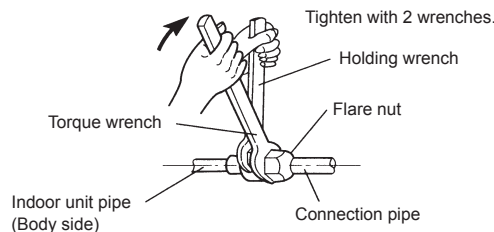

Flare nut [mm (in.)]	Tightening torque [N·m (kgf·cm)]
6.35 (1/4) dia.	16 to 18 (160 to 180)
9.52 (3/8) dia.	32 to 42 (320 to 420)
12.70 (1/2) dia.	49 to 61 (490 to 610)
15.88 (5/8) dia.	63 to 75 (630 to 750)
19.05 (3/4) dia.	90 to 110 (900 to 1,100)

4.4. Installing heat insulation

CAUTION

After checking for gas leaks (refer to the Installation Manual of the outdoor unit), perform this section.

Install heat insulation around both the large (gas) and small (liquid) pipes. Failure to do so may cause water leaks.

After checking for gas leaks, insulate by wrapping insulation around the two parts (gas and liquid) of the indoor unit coupling, using the Coupler Heat Insulation. After installing the Coupler Heat Insulation, wrap both ends with vinyl tape so that there is no gap.

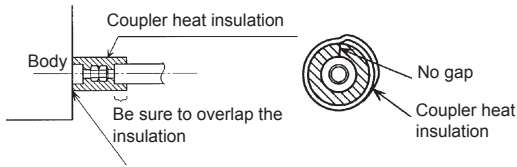

CAUTION

Must fit tightly against body without any gap.

5. INSTALLING DRAIN HOSE

Install the drain hose according to the measurements given in the following figure.

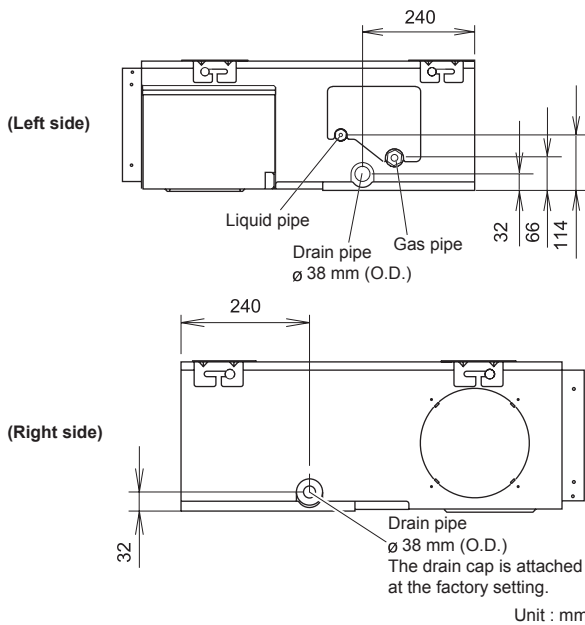

CAUTION

Install the drain hose in accordance with the instructions in this Installation Manual and keep the area warm enough to prevent condensation. Problems with the piping may lead to water leaks.

NOTE:

Install the drain hose.

- Install the drain hose with downward gradient (1/50 to 1/100) and so there are no rises or traps in the hose.
- Use general hard polyvinyl chloride pipe (VP25) [outside diameter 38 mm] and connect it with adhesive (polyvinyl chloride) so that there is no leakage.
- When the hose is long, install supporters.
- Do not perform air bleeding.
- Always heat insulate the indoor side of the drain hose.

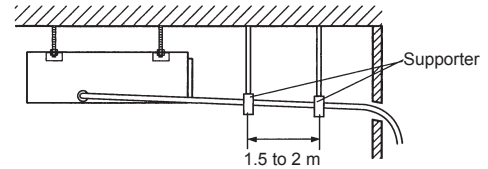
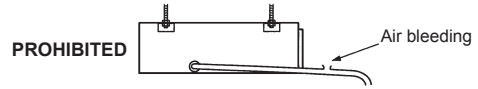
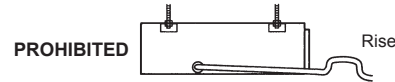
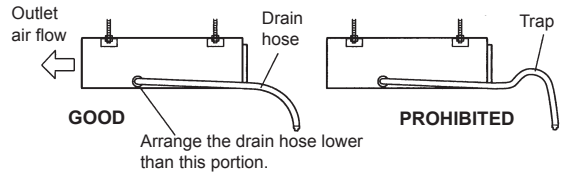

- When the unit is shipped from the factory, the drain port is on the left side (control box side).
- When using the drain port on the right side of the unit, reinstall the drain cap to the left side drain port.

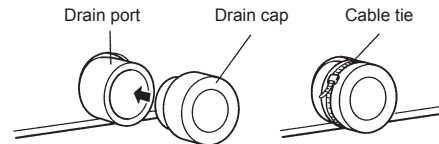

CAUTION

Always check that the drain cap is installed to the unused drain port and is fastened with the Cable tie. If the drain cap is not installed, or is not sufficiently fastened by the Cable tie, water may drip during the cooling operation.

- Cut the drain hose insulation at a position approximately 80 mm from the end with cutters, etc.
- Stick the large drain hose insulation at the drain hose installation side.
- Stick the small drain hose insulation at the drain cap side.

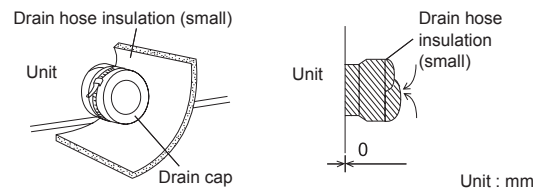
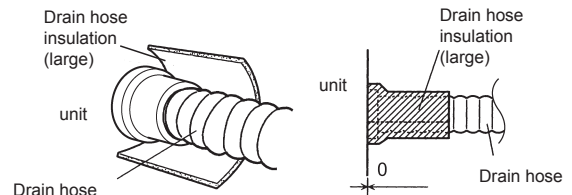
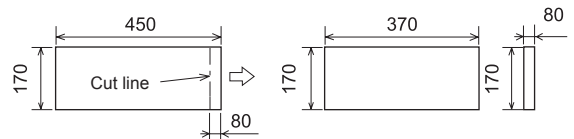

- Cover the drain cap with the drain hose insulation.

6. ELECTRICAL WIRING

Cable	Cable size (mm ²)	Type	Remarks
Connection cable	1.5 (MIN.)	Type 60245 IEC57	3Cable+Ground, 1φ230V

Max. Cable Length: Limit voltage drop to less than 2%. Increase cable gauge if voltage drop is 2% or more.

For simultaneous multi (22,24 model only)

Bus wire	Conductor size (mm ²)	Max length (m)
Bus wire	0.3 (MIN.)	500*

* This length shall be the total extended length in the system of the group.

(Total length of bus wire and remote controller cable.)

- Install all electrical works in accordance to standard.
- Install the disconnect device with a contact gap of at least 3mm in all poles nearby the units. (Both indoor unit and outdoor unit)
- Wiring size must comply with the applicable country or region's regulations.

⚠ WARNING

Electrical work must be performed in accordance with this Manual by a person certified under the national or regional regulations. Be sure to use a dedicated circuit for the unit.

An insufficient power supply circuit or improperly performed electrical work can cause serious accidents such as electric shock or fire.

Before starting work, check that power is not being supplied to the indoor unit and outdoor unit.

For wiring, use the prescribed type of cables, connect them securely, making sure that there are no external forces of the cables applied to the terminal connections. Improperly connected or secured cables can cause serious accidents such as overheating the terminals, electric shock, or fire.

Securely install the electrical box cover on the unit.

An improperly installed electrical box cover can cause serious accidents such as electric shock or fire through exposure to dust or water.

Install sleeves into any holes made in the walls for wiring. Otherwise, a short circuit could result.

Use the included connection cables and power cables or ones specified by the manufacturer. Improper connections, insufficient insulation, or exceeding the allowable current can cause electric shock or fire.

Do not modify the power cables, use extension cables, or use any branches in the wiring. Improper connections, insufficient insulation, or exceeding the allowable current can cause electric shock or fire.

Match the terminal block numbers and connection cable colors with those of the outdoor unit or branch box. Erroneous wiring may cause burning of the electric parts.

Securely connect the connection cables to the terminal board. In addition, secure the cables with wiring holders. Improper connections, either in the wiring or at the ends of the wiring, can cause a malfunction, electric shock, or fire.

Always fasten the outside covering of the connection cable with the cable clamp. (If the insulator is chafed, electric leakage may occur.)

Install a earth leakage breaker. In addition, install the earth leakage breaker so that the entire AC main power supply is cut off at the same time. Otherwise, electric shock or fire could result.

Always connect the earth cable.
Improper grounding work can cause electric shocks.

Install the remote controller cables so as not to be direct touched with your hand.

Perform wiring work in accordance with standards so that the air conditioner can be operated safely and positively.

Connect the connection cable firmly to the terminal board. Imperfect installation may cause a fire.

⚠ CAUTION

Ground the unit.
Do not connect the earth cable to a gas pipe, water pipe, lightning rod, or a telephone earth cable.
Improper grounding may cause electric shock.

Do not connect power supply cables to the transmission or remote controller terminals, as this will damage the product.

Never bundle the power supply cable and transmission cable, remote controller cable together.
Separate these cable by 50 mm or more.
Bundling these cables together will cause miss operation or breakdown.

When handling PCB, static electricity charged in the body may cause malfunction of the PCB. Follow the cautions below:

- Establish a ground for the indoor and outdoor units and peripheral devices.
- Cut power (breaker) off.
- Touch metal part of the indoor and outdoor units for more than 10 seconds to discharge static electricity charged in the body.
- Do not touch terminals of parts and patterns implemented on PCB.

- (1) Use ring terminals with insulating sleeves as shown in the figure below to connect to the terminal block.
- (2) Securely clamp the ring terminals to the cables using an appropriate tool so that the cables do not come loose.
- (3) Use the specified cables, connect them securely, and fasten them so that there is no stress placed on the terminals.
- (4) Use an appropriate screwdriver to tighten the terminal screws.
Do not use a screwdriver that is too small, otherwise, the screw heads may be damaged and prevent the screws from being properly tightened.
- (5) Do not tighten the terminal screws too much, otherwise, the screws may break.
- (6) See the table for the terminal screw tightening torques.
- (7) Please do not fix 2 power supply cables with 1 screw.

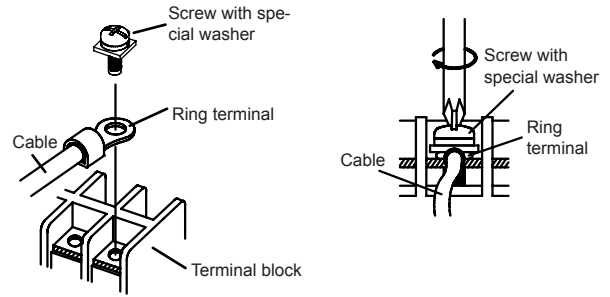
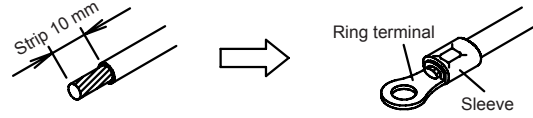

⚠ WARNING

Use ring terminals and tighten the terminal screws to the specified torques, otherwise, abnormal overheating may be produced and possibly cause heavy damage inside the unit.

Tightening torque [N·m (kgf·cm)]

M4 screw	1.2 to 1.8 (12 to 18)
M5 screw	2.0 to 3.0 (20 to 30)

6.1. Wiring system diagram

Connection diagrams

Standard pair:

Connection cable to outdoor unit

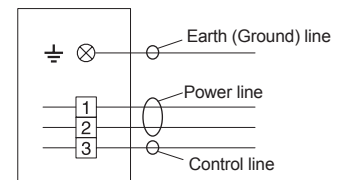

Wired remote controller cable

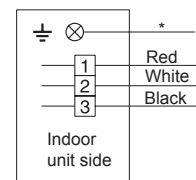

*Ground the remote controller if it has a earth (ground) wire.

Simultaneous twin (22, 24 type only)
Connection cable

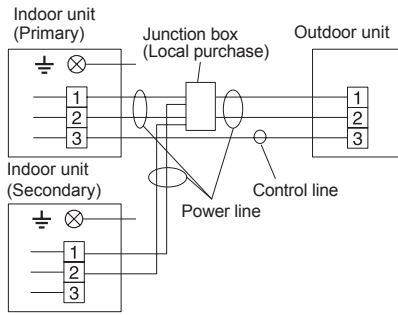

Wired remote controller cable

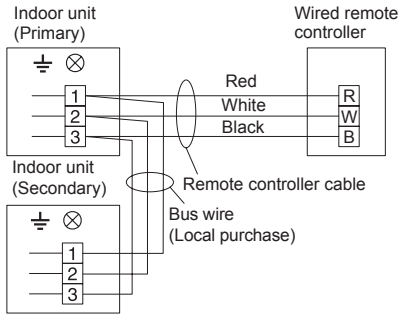

Wired remote controller is recommended using simultaneous twin or triple connection.

⚠ CAUTION
Tighten the indoor unit connection cable and power supply indoor and outdoor unit, branch box terminal board connections firmly with the terminal board screws. Faulty connection may cause a fire.
If the indoor unit connection cable and power supply are wired incorrectly, the air conditioner may be damaged.
Connect the indoor unit connection cable by matching the numbers of the outdoor and indoor units terminal board numbers as shown in terminal label.
Earth (Ground) both the indoor and outdoor, units by attaching a earth (ground) cable.
Unit shall be grounded in compliance with the country or region's regulations.

⚠ CAUTION
Be sure to refer to the above diagram for do correct field wiring. Wrong wiring causes malfunction of the unit.
Check local electrical rules and also any specific wiring instructions or limitation.

6.2. Connection cable preparation

Keep the earth (ground) wire longer than the other wires.

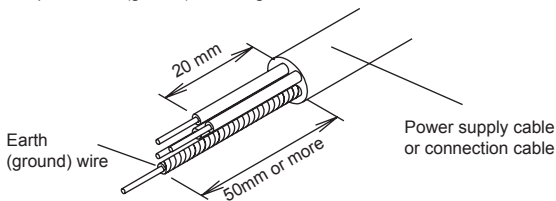

Use a 4-core wire cable.

6.3. Connection of wiring

⚠ CAUTION
Use care not to mistake the power supply cable and connection wires when installing.

(1) Remove the control box cover and install each connection wire.

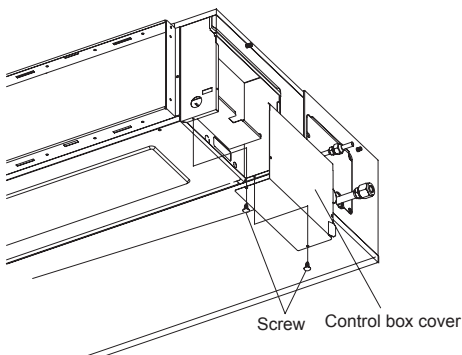

(2) 22,24 model

After wiring is complete, secure the remote controller cable, transmission cable, with the cable tie and the clammer.

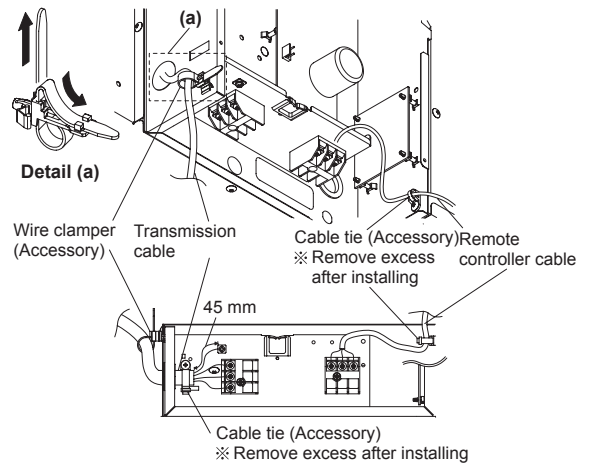

(2) Other models

After wiring is complete, secure the remote controller cable, connection cable, and power supply cable with the cable clamps.

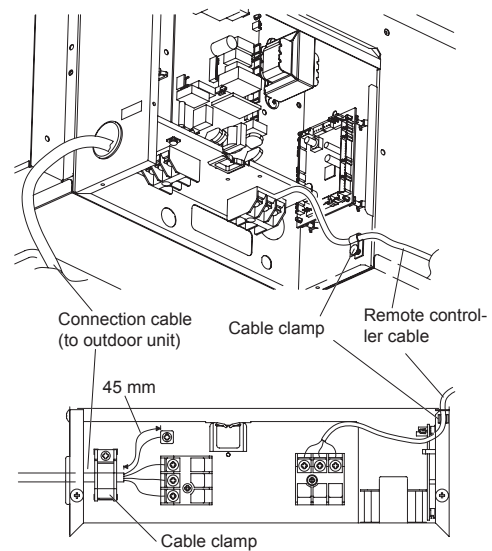

(3) Install control box cover.

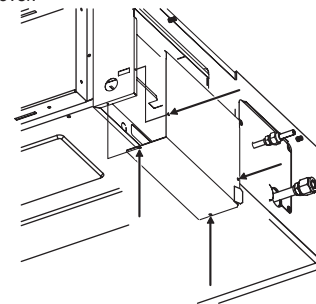

Adjust the position of the screws for control box cover according to the installation.

⚠ CAUTION
Do not bundle the remote controller cable, or wire the remote controller cable in parallel, with the indoor unit connection wire (to the outdoor unit) and the power supply cable. It may cause erroneous operation.

7. REMOTE CONTROLLER SETTING

CAUTION

When detecting the room temperature using the remote controller, please set up the remote controller according to the following conditions. If the remote controller is not located properly, the correct room temperature will not be detected, and thus abnormal conditions like "not cooled" or "not heated" will occur even if the air-conditioner is running normally.

- Locate where an average temperature for the room being air conditioned will be sensed.
- Do not locate directly exposed to the outlet air from the air-conditioner.
- Locate out of direct sunlight.
- Locate away from the influence of other heat sources.

Temperature sensor

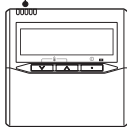

Do not touch the remote controller PC board and PC board parts directly with your hands.

Do not wire the remote controller cable together with or parallel to the connection cables, and power supply cable of the INDOOR UNIT and OUTDOOR UNIT, BRANCH BOX. It may cause erroneous operation.

When installing the bus wire near a source of electromagnetic waves, use shielded wire.

Do not set the DIP switches, either on the air conditioner or the remote controller, in any way other than indicated in this manual that is supplied with the air conditioner. Doing so may result in improper operation.

7.1. Installing the remote controller

Open the operation panel on the front of the remote controller, remove the 2 screws indicated in the following figure, and then remove the front case of the remote controller.

When installing the remote controller, remove the connector from the front case. The wires may break if the connector is not removed and the front case hangs down. When installing the front case, connect the connector to the front case.

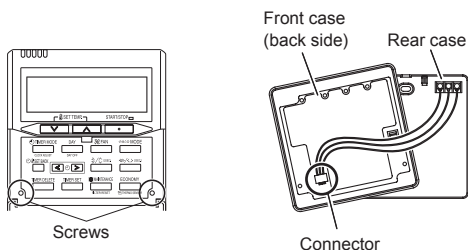

When remote controller cable is concealed

- (1) Conceal the remote controller cable.
- (2) Pass the remote controller cable through the hole in the rear case and connect the remote controller cable to the remote controller terminal board specified in figure.
- (3) Clamp the remote controller cable sheath with the cable tie as shown in figure.
- (4) Cut off the excess cable tie.
- (5) Install the rear case to the wall, box, etc., with 2 screws figure.

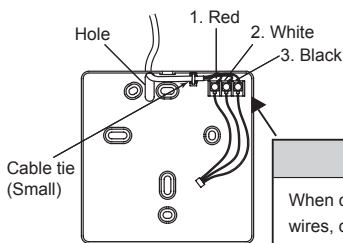

CAUTION

When connecting the remote controller wires, do not overtighten the screws.

[Example]

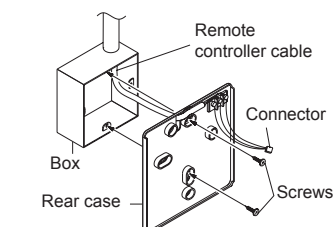

Ground the remote controller if it has a ground wire.

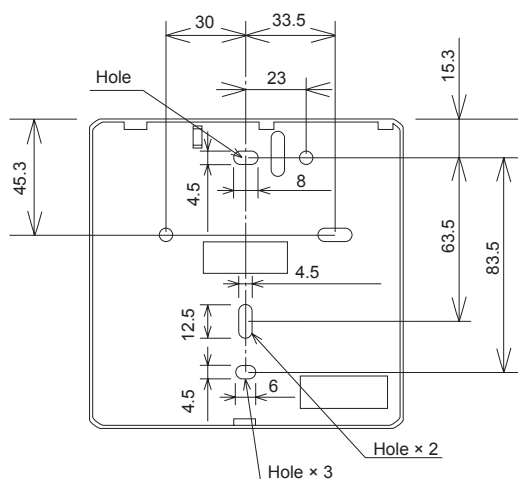
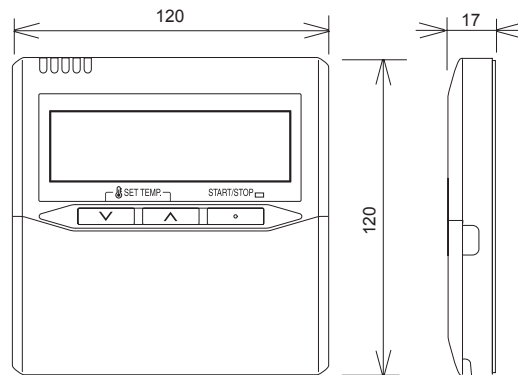
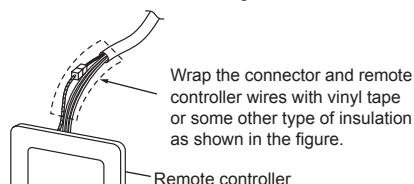

Unit: mm

CAUTION

Install the remote controller wires so as not to be direct touched with your hand.

Do not touch the remote controller PC board and PC board parts directly with your hands.

7.2. Setting the DIP switches

Set the remote controller DIP switches.

[Example]

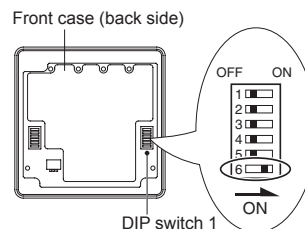

NO.	SW state		Detail
	OFF	ON	
1	★		Cannot be used. (Do not change)
2	★		Dual remote controller setting * Refer to "8.4.2. Dual remote controllers."
3	★		Cannot be used. (Do not change)
4	★		Cannot be used. (Do not change)
5	★		Cannot be used. (Do not change)
6	★ Invalidity	Validity	Memory backup setting * Set to ON to use batteries for the memory backup. If batteries are not used, all of the settings stored in memory will be deleted if there is a power failure.

(★ Factory setting)

8. FUNCTION SETTING

⚠ CAUTION

Confirm whether the wiring work for outdoor unit has been finished.

Confirm whether the cover for electric control box on the outdoor unit is close.

8.1. Turning on the power

- Check the remote controller wiring and DIP switch settings.
- Install the front case.
When installing the front case, connect the connector to the front case.
- Check the indoor and outdoor unit wiring and circuit board switch settings, and then turn on the indoor and outdoor units. After "9F" has flashed on the set temperature display for several seconds, the clock display will appear in the center of the remote controller display.
The clock display will appear in the center of the remote controller display.



8.2. Function setting

This procedure changes the function settings used to control the indoor unit according to the installation conditions. Incorrect settings can cause the indoor unit to malfunction. This procedure should be performed by authorized installation or service personnel only. Perform the "FUNCTION SETTING" according to the installation conditions using the remote controller. (Refer to the indoor unit installation manual for details on the function numbers and setting values.)

- Press the SET TEMP. buttons (V) (Λ) and FAN button simultaneously for more than 5 seconds to enter the function setting mode.

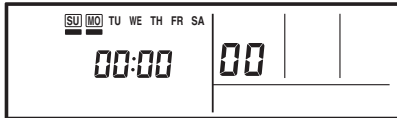
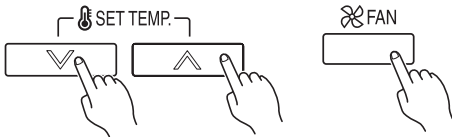

- Press the SET BACK button to select the indoor unit number.

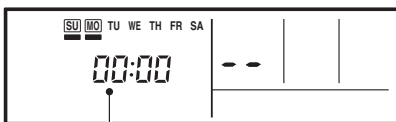

Unit number of INDOOR UNIT

- Press the SET TIME (<) (>) buttons to select the function number.

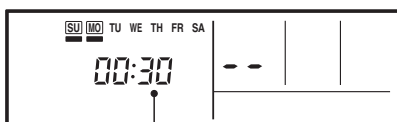
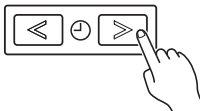

Function number

- Press the SET TEMP. buttons (V) (Λ) to select the setting value.
The display flashes as shown to the right during setting value selection.

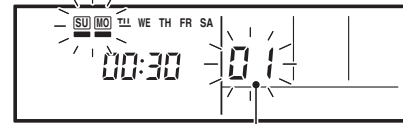
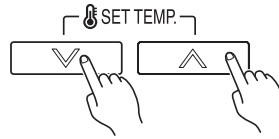

Setting value

- Press the TIMER SET button to confirm the setting.
Press the TIMER SET button for a few seconds until the setting value stops flashing. If the setting value display changes or if "-" is displayed when the flashing stops, the setting value has not been set correctly.
(An invalid setting value may have been selected for the indoor unit.)
- Repeat steps 2 to 5 to perform additional settings.
Press the SET TEMP. buttons (V) (Λ) and FAN button simultaneously again for more than 5 seconds to cancel the function setting mode. In addition, the function setting mode will be automatically canceled after 1 minute if no operation is performed.
- After completing the FUNCTION SETTING, be sure to turn off the power and turn it on again.

⚠ CAUTION

After turning off the power, wait 30 seconds or more before turning on it again. The FUNCTION SETTING doesn't become effective if it doesn't do so.

• Function Details

(1) Filter Sign

The indoor unit has a sign to inform the user that it is time to clean the filter. Select the time setting for the filter sign display interval in the table below according to the amount of dust or debris in the room. If you do not wish the filter sign to be displayed, select the setting value for "No indication".

(♦... Factory setting)

Setting description	Function number	Setting value
Standard (2500 hours)	11	00
Long interval (4400 hours)		01
Short interval (1250 hours)		02
♦ No indication		03

(2) Static pressure

Select appropriate static pressure according to the installation conditions.

(♦... Factory setting)

Setting description	Function number	Setting value
♦ Normal	21	00
High static pressure 1		01
High static pressure 2		02
High static pressure 3		03

Determine the wind volume in each mode i.e., applicable range of static pressure, referring to "8.3. Static pressure characteristics." (The unit is factory-set to "00".)

(3) Cooling room temperature correction

Depending on the installed environment, the room temperature sensor may require a correction.

The settings may be selected as shown in the table below.

(◆... Factory setting)

Setting description	Function number	Setting value
◆ Standard	30	00
Slightly lower control		01
Lower control		02
Warmer control		03

(4) Heating room temperature correction

Depending on the installed environment, the room temperature sensor may require a correction.

The settings may be changed as shown in the table below.

(◆... Factory setting)

Setting description	Function number	Setting value
◆ Standard	31	00
Lower control		01
Slightly warmer control		02
Warmer control		03

(5) Auto restart

Enable or disable automatic system restart after a power outage.

(◆... Factory setting)

Setting description	Function number	Setting value
◆ Yes	40	00
No		01

* Auto restart is an emergency function such as for power failure etc. Do not start and stop the indoor unit by this function in normal operation. Be sure to operate by the control unit, or external input device.

(6) Indoor room temperature sensor switching function

(Only for Wired remote controller)

The following settings are needed when using the Wired remote controller temperature sensor.

(◆... Factory setting)

Setting description	Function number	Setting value
◆ No	42	00
Yes		01

* If setting value is "00" :

Room temperature is controlled by the indoor unit temperature sensor.

* If setting value is "01" :

Room temperature is controlled by either indoor unit temperature sensor or remote controller unit sensor.

(7) Wireless remote controller signal code

Change the indoor unit Signal Code, depending on the wireless remote controllers.

(◆... Factory setting)

Setting description	Function number	Setting value
◆ A	44	00
B		01
C		02
D		03

(8) External input control

"Operation/Stop" mode or "Forced stop" mode can be selected.

(◆... Factory setting)

Setting description	Function number	Setting value
◆ Operation/Stop mode	46	00
(Setting forbidden)		01
Forced stop mode		02

Setting record

- Record any changes to the settings in the following table.

Setting	Setting Value
(1) Filter sign	
(2) Static pressure	
(3) Cooling room temperature correction	
(4) Heating room temperature correction	
(5) Auto restart	
(6) Indoor room temperature sensor switching function	
(7) Wireless remote controller signal code	
(8) External input control	

After completing the FUNCTION SETTING, be sure to turn off the power and turn it on again.

SETTING THE ROOM TEMPERATURE DETECTION LOCATION

The detection location of the room temperature can be selected from the following 2 examples. Choose the detection location that is best for the installation location.

A. Indoor unit setting (factory setting)

The room temperature is detected by the indoor unit temperature sensor.

- When the THERMO SENSOR button is pressed, the lock display flashes because the function is locked at the factory.

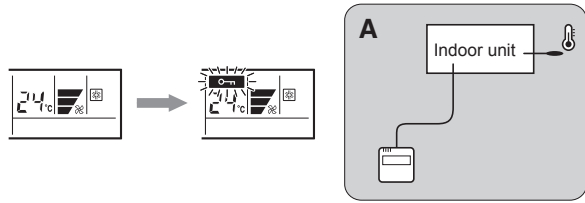

B. Indoor unit/remote controller setting (room temperature sensor selection)

The temperature sensor of the indoor unit or the remote controller can be used to detect the room temperature.

- Enable the room temperature sensor selection in FUNCTION SETTING, which will be previous page.
- Press the THERMO SENSOR button for 5 seconds or more to select the temperature sensor of the indoor unit or the remote controller.

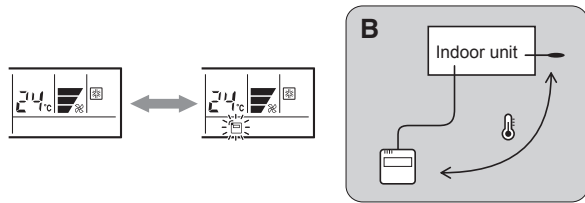

⚠ CAUTION	
①	 <p>When select the "Remote controller setting", if the detected temperature value between the temperature sensor of the indoor unit and the temperature sensor of the remote controller varies significantly, it is likely to return to the control status of temperature sensor of the indoor unit temporarily.</p>
②	As the temperature sensor of remote controller detects the temperature near the wall, when there is a certain difference between the room temperature and the wall temperature, the sensor will not detect the room temperature correctly sometimes. Especially when the outer side of the wall on which the sensor is positioned is exposed to the open air, it is recommended to use the temperature sensor of the indoor unit to detect the room temperature when the indoor and outdoor temperature difference is significant.
③	The temperature sensor of the remote controller is not only used when there is a problem in the detection of the temperature sensor of the indoor unit.

NOTE:

If the function to change the temperature sensor is used as shown in examples A (other than example B), be sure to lock the detection location. If the function is locked, the lock display  will flash when the THERMO SENSOR button is pressed.

8.3. Static pressure characteristic

⚠ CAUTION	
If the applicable static pressure does not match the static pressure mode, the static pressure mode maybe changed to another mode automatically.	

RECOMMENDED RANGE OF EXTERNAL STATIC PRESSURE [Pa]
30 to 150

1. STATIC PRESSURE MODE

It is necessary to set up a static pressure mode for each usage of static pressure. Determine the applicable range of static pressure in each mode and wind volume, referring to the Technical manual.

2. MODE SETTING

It is possible to change the setting of static pressure mode. Refer to "8.2. Function setting."

8.4. Special installation methods

⚠ CAUTION	
When setting DIP switches, do not touch any other parts on the circuit board directly with your bare hands.	
Be sure to turn off the main power.	

8.4.1. Group control system

A number of indoor units can be operated at the same time using a single remote controller.

(1) Wiring method (indoor unit to remote controller)

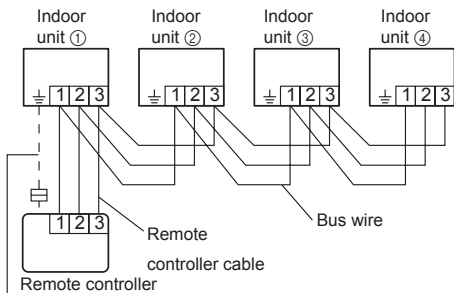

When ground wire is necessary

(2) DIP switch setting (Indoor unit)

Set the unit number of each indoor unit using the DIP switches on the indoor unit circuit board. (See the following table and figure.)
The DIP switches are normally set to make the unit number 00.

Indoor unit	Unit number	DIP SWITCH No.			
		1	2	3	4
①	00	OFF	OFF	OFF	OFF
②	01	ON	OFF	OFF	OFF
③	02	OFF	ON	OFF	OFF
④	03	ON	ON	OFF	OFF
⑤	04	OFF	OFF	ON	OFF
⑥	05	ON	OFF	ON	OFF
⑦	06	OFF	ON	ON	OFF
⑧	07	ON	ON	ON	OFF
⑨	08	OFF	OFF	OFF	ON
⑩	09	ON	OFF	OFF	ON
⑪	10	OFF	ON	OFF	ON
⑫	11	ON	ON	OFF	ON
⑬	12	OFF	OFF	ON	ON
⑭	13	ON	OFF	ON	ON
⑮	14	OFF	ON	ON	ON
⑯	15	ON	ON	ON	ON

Example : unit number 03

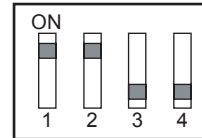

NOTE

Be sure to set the unit numbers sequentially.

(3) Remote controller setting

1. Turn on all of the indoor units.

Turn on the indoor unit with the unit number 00 last. (Within 1 minute)

2. Set the refrigerant circuit address. (Assign the same number to all of the indoor units connected to an outdoor unit.)

Indoor unit	Unit number	Function Number	Setting Value
①	00	02	00 ~ 15
②	01		
⑬	14		
⑯	15		

3. Set the "primary" and "secondary" settings. (Set the indoor unit that is connected to the outdoor unit using a transmission cable as the "primary".)

	Function Number	Setting Value
Primary	51	00
Secondary		01

4. After completing the function settings, turn off all of the indoor units, and then turn them back on.

* If error code 21, 22, 24, or 27 is displayed, there may be an incorrect setting. Perform the remote controller setting again.

NOTES:

- When different indoor unit models are connected using the group control system, some functions may no longer be available.
- If the group control system contains multiple units that are operated simultaneously, connect and set the units as shown below.
- Auto-changeover operates under the same mode with model unit number 00.
- It should not be connected to any other Gr that is not of the same series (A**G only).

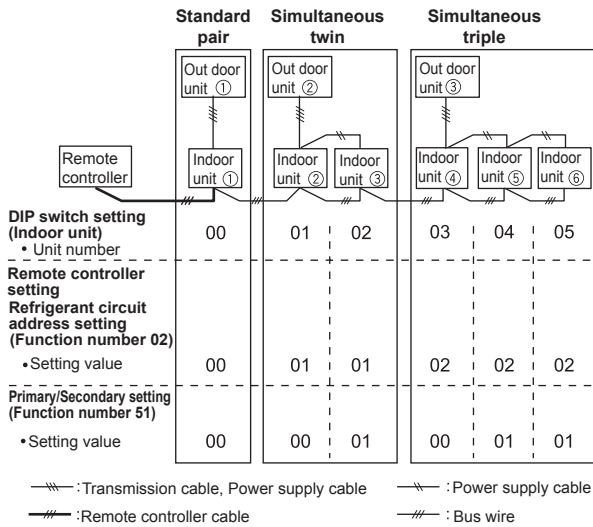

Make sure that the indoor unit with the unit number 00 is connected to the outdoor unit using a transmission cable.

8.4.2. Dual remote controllers

- 2 separate remote controllers can be used to operate the indoor units.
- The timer and self-diagnosis functions cannot be used on the secondary units.

(1) Wiring method (indoor unit to remote controller)

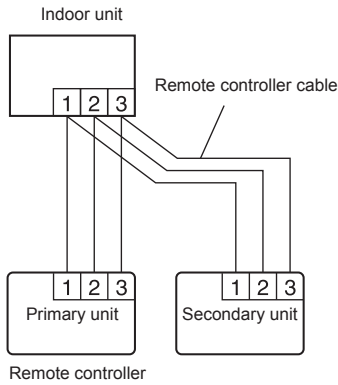

(2) Remote controller DIP switch 1 setting

Set the remote controller DIP switch 1 No. 2 according to the following table. (Refer to "7.2. Setting the DIP switches.")

Number of remote controllers	Primary unit	Secondary unit
	DIP SW 1 No. 2	DIP SW 1 No. 2
1 (Normal)	OFF	—
2 (Dual)	OFF	ON

8.4.3. Simultaneous multi-system operation (22,24 model)

- By combining with an outdoor unit, 2 units for twin indoor units, can be switched ON/OFF simultaneously.

(1) Wiring method

- Refer to 6.ELECTRICAL WIRING for wiring procedure and wiring method.
- The indoor unit is connected the outdoor unit using a transmission cable is "primary".
- Connect the remote controller wire to the primary unit.

Twin type

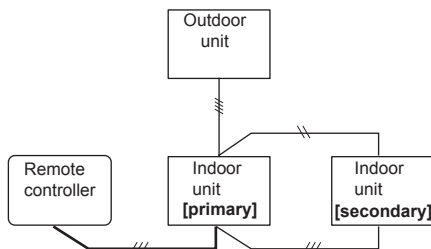

(2) DIP switch setting (Indoor unit)

Set the unit number of each indoor unit using the DIP switches on the indoor unit circuit board. (See the following table and figure.)

The DIP switches are normally set to make the unit number 00.

Indoor unit	Unit number	DIP SWITCH No.			
		1	2	3	4
①	00	OFF	OFF	OFF	OFF
②	01	ON	OFF	OFF	OFF
③	02	OFF	ON	OFF	OFF

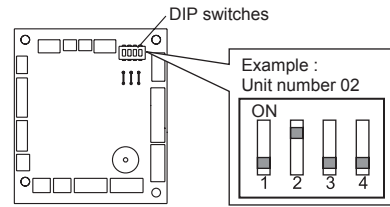

Circuit board in the control box of indoor unit.

NOTE:

Be sure to set the unit numbers sequentially.

(3) Remote controller setting

1. Turn on all of the indoor units.
Therefore, continue with the setting procedure.
2. Set the primary and secondary settings.
Set the indoor unit that is not connected to the outdoor unit using a transmission cable as the "01".
(The setting value is factory-set to "00".)

Indoor unit	Unit number	Function Number	Setting Value
①	00	51	00(primary)
②	01		01(secondary)

3. After completing the function settings, turn off all of the indoor units, and then turn them back on.
* If error code 21, 22, 24 or 27 is displayed, there may be an incorrect setting. Perform the remote controller setting again.

Twin type

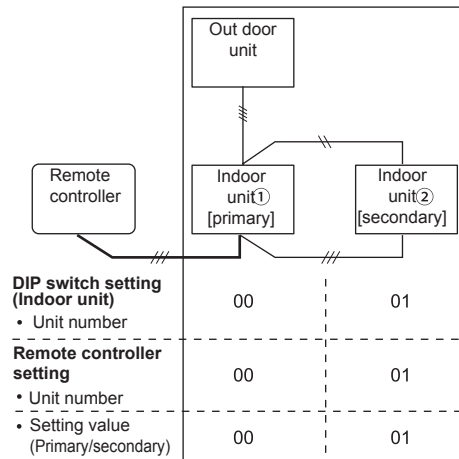

9. FRESH AIR INTAKE

(Processing before use)

- (1) When taking in fresh air, cut a slit shaped cabinet in the left side of the outer case with nippers.

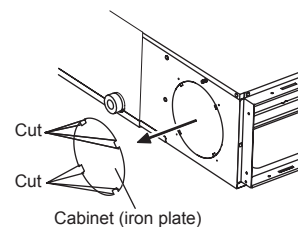

CAUTION

When removing the cabinet (iron plate), be careful not to damage the indoor unit internal parts and surrounding area (outer case).

When processing the cabinet (iron plate), be careful not to injure yourself with burrs, etc.

(2) Install the round flange (option parts) to the fresh air intake.

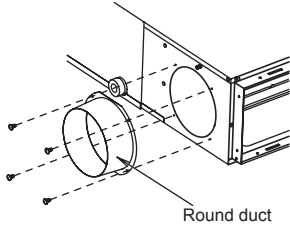

(3) Connect the duct to the round flange.

(4) Seal with a band and vinyl tape, etc. so that air does not leak from the connection.

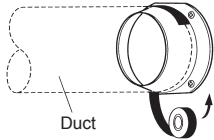

10. TEST RUN

CHECK ITEMS

- (1) Is operation of each button on the remote controller normal?
 - (2) Do not air flow direction louvers operate normally?
 - (3) Is the drain normal?
 - (4) Is there any abnormal noise and vibration during operation?
- Do not operate the air conditioner in test run for a long time.

[OPERATION METHOD]

- For the operation method, refer to the operating manual.

- (1) Stop the air conditioner operation.
- (2) Press the MODE button and the FAN button simultaneously for 2 seconds or more to start the test run.

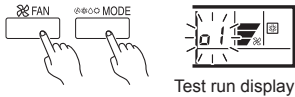

- (3) Press the START/STOP button to stop the test run.

If "C0" appears in the unit number display, there is a remote controller error. Refer to the installation manual included with the remote controller.

Unit number	Error code	Content
C0	15	Incompatible indoor unit is connected
C0	12	Indoor unit ↔ remote controller communication error

[Using the wireless remote controller for test run] (Option)

- For the operation method, refer to the operating manual.
- The outdoor unit may not operate depending on the room temperature. In this case, press the TEST RUN button on the wireless remote controller while the air conditioner is running. (Point the transmitter section of the wireless remote controller toward the air conditioner and press the TEST RUN button with the tip of a ball-point pen, etc.)

Transmitter section

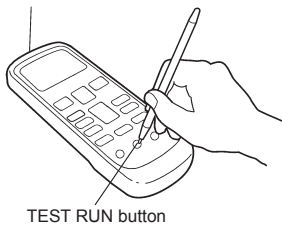

- To end test operation, press the wireless remote controller START/STOP button. (When the air conditioner is run by pressing the TEST RUN button, the OPERATION indicator lamp and TIMER indicator lamp will simultaneously flash slowly.)

11. CHECK LIST

Pay special attention to the check items below when installing the indoor unit(s). After installation is complete, be sure to check the following check items again.

CHECK ITEMS	If not performed correctly	CHECK BOX
Has the indoor unit been installed correctly?	Vibration, noise, indoor unit may drop	
Has there been a check for gas leaks (refrigerant pipes)?	No cooling, No heating	
Has heat insulation work been completed?	Water leakage	
Does water drain easily from the indoor units?	Water leakage	
Are the wires and pipes all connected completely?	No operation, heat or burn damage	
Is the connection cable the specified thickness?	No operation, heat or burn damage	
Are the inlets and outlets free of any obstacles?	No cooling, No heating	
After installation is completed, has the proper operation and handling been explained to the user?		

12. OPTIONAL KIT INSTALLATION (OPTION)

WARNING

Regulation of cable differs from each locality, refer in accordance with local rules.

This air conditioner can be connected with the following optional kits.

Option type	Connector No.
UTY-XSZX (Remote sensor unit)	CN8
UTD-ECS5A (External input)	CN102
UTD-ECS5A (External output)	CN103
UTZ-PX1NBA (Drain pump unit)	CN106 (Drain pump) CN9 (Float SW)

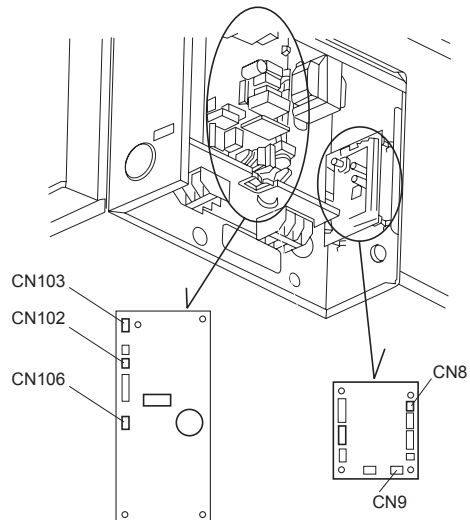

13. CUSTOMER GUIDANCE

Explain the following to the customer in accordance with the operating manual:

- (1) Starting and stopping method, operation switching, temperature adjustment, timer, air flow switching, and other remote controller operations.
- (2) Air filter removal and cleaning, and how to use the air louvers.
- (3) Give the operating and installation manuals to the customer.
- (4) If the signal code is changed, explain to the customer how it changed (the system returns to signal code A when the batteries in the remote controller are replaced).
- * (4) is applicable to using wireless remote controller.

14. ERROR CODES

If you use a wired type remote controller, error codes will appear on the remote controller display. If you use a wireless remote controller, the lamps on the IR receiver unit will output error codes by way of blinking patterns. See the lamp blinking patterns and error codes in the table below. An error display is displayed only during operation.

Error display			Wired remote controller Error code	Description
OPERATION lamp (green)	TIMER lamp (orange)	ECONOMY lamp (green)		
●(1)	●(1)	◇	11	Serial communication error
●(1)	●(2)	◇	12	Wired remote controller communication error
●(1)	●(5)	◇	15	Check run unfinished
●(2)	●(1)	◇	21	Unit number or Refrigerant circuit address setting error [Simultaneous Multi]
●(2)	●(2)	◇	22	Indoor unit capacity error
●(2)	●(3)	◇	23	Combination error
●(2)	●(4)	◇	24	• Connection unit number error (indoor secondary unit) [Simultaneous Multi] • Connection unit number error (indoor unit or branch unit) [Flexible Multi]
●(2)	●(7)	◇	27	Primary unit, secondary unit setup error [Simultaneous Multi]
●(3)	●(1)	◇	31	Power supply interruption error
●(3)	●(2)	◇	32	Indoor unit PCB model information error
●(3)	●(5)	◇	35	Manual auto switch error
●(4)	●(1)	◇	41	Room temp. sensor error
●(4)	●(2)	◇	42	Indoor unit Heat Ex. Middle temp. sensor error
●(5)	●(1)	◇	51	Indoor unit fan motor error
●(5)	●(3)	◇	53	Drain pump error
●(5)	●(7)	◇	57	Damper error
●(5)	●(15)	◇	5U	Indoor unit error
●(6)	●(2)	◇	62	Outdoor unit main PCB model information error or communication error
●(6)	●(3)	◇	63	Inverter error
●(6)	●(4)	◇	64	Active filter error, PFC circuit error
●(6)	●(5)	◇	65	Trip terminal L error
●(6)	●(10)	◇	6A	Display PCB microcomputers communication error
●(7)	●(1)	◇	71	Discharge temp. sensor error
●(7)	●(2)	◇	72	Compressor temp. sensor error

Error display			Wired remote controller Error code	Description
OPERATION lamp (green)	TIMER lamp (orange)	ECONOMY lamp (green)		
●(7)	●(3)	◇	73	Outdoor unit Heat Ex. liquid temp. sensor error
●(7)	●(4)	◇	74	Outdoor temp. sensor error
●(7)	●(5)	◇	75	Suction Gas temp. sensor error
●(7)	●(6)	◇	76	• 2-way valve temp. sensor error • 3-way valve temp. sensor error
●(7)	●(7)	◇	77	Heat sink temp. sensor error
●(8)	●(2)	◇	82	• Sub-cool Heat Ex. gas inlet temp. sensor error • Sub-cool Heat Ex. gas outlet temp. sensor error
●(8)	●(3)	◇	83	Liquid pipe temp. sensor error
●(8)	●(4)	◇	84	Current sensor error
●(8)	●(6)	◇	86	• Discharge pressure sensor error • Suction pressure sensor error • High pressure switch error
●(9)	●(4)	◇	94	Trip detection
●(9)	●(5)	◇	95	Compressor rotor position detection error (permanent stop)
●(9)	●(7)	◇	97	Outdoor unit fan motor 1 error
●(9)	●(8)	◇	98	Outdoor unit fan motor 2 error
●(9)	●(9)	◇	99	4-way valve error
●(9)	●(10)	◇	9A	Coil (expansion valve) error
●(10)	●(1)	◇	A1	Discharge temp. error
●(10)	●(3)	◇	A3	Compressor temp. error
●(10)	●(4)	◇	A4	High pressure error
●(10)	●(5)	◇	A5	Low pressure error
●(13)	●(2)	◇	J2	Branch boxes error [Flexible Multi]

Display mode ● : 0.5s ON / 0.5s OFF
◇ : 0.1s ON / 0.1s OFF
() : Number of flashing

[Troubleshooting at the remote controller LCD]

This is possible only on the wired remote controller.

[Self-diagnosis]

If an error occurs, the following display will be shown. ("Er" will appear in the set room temperature display.)

