

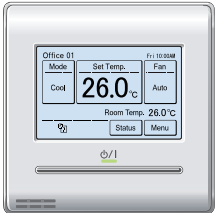

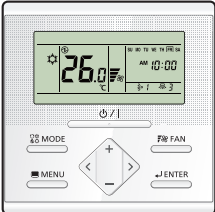

13. Accessories

Part name	Exterior	Q'ty	Part name	Exterior	Q'ty
Operating manual (For indoor unit)		1	Coupler heat insulation (small)		1
Operating manual (CD-ROM)		1	Cable tie (large)		4
Operating manual (For remote controller)		1	Cable tie (medium)		1
Installation manual (For indoor unit)		1	Cable tie (small)		1
Installation manual (For remote controller)		1	Remote controller		1
Special nut A (large flange)		4	Remote controller accessories		1 set
Special nut B (small flange)		4	Drain hose insulation		1
Washer		8	Drain hose		1
Coupler heat insulation (large)		1	Hose band		1

14. Optional parts

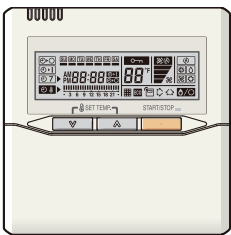
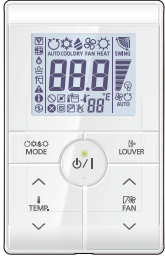
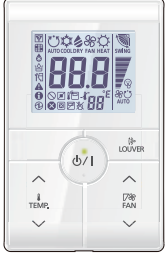



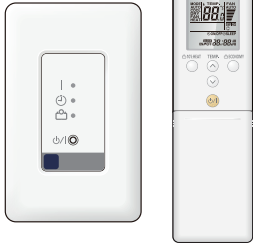

14-1. Controllers

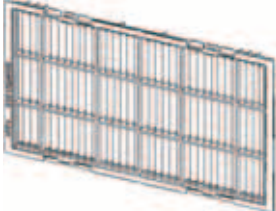

Exterior	Part name	Model name	Summary
	Wired remote controller	UTY-RNRYZ*	Easy finger touch operation with LCD panel. Backlit LCD enables easy operation in a dark room. Wire type: Non-polar 2-wire
	Wired remote controller	UTY-RLRY	High visibility and easy operation. Room temperature can be accurately controlled using the built-in thermo sensor. Wire type: Non-polar 2-wire
	Wired remote controller	UTY-RVNYM	Large and full-dot liquid crystal screen, wide and large keys easy to press, user-intuitive arrow key. Wire type: Polar 3-wire
	Wired remote controller	UTY-RNNYM	Room temperature can be controlled by detecting the temperature accurately with built-in thermo sensor. Wire type: Polar 3-wire
	Simple remote controller	UTY-RSRY	Compact remote controller concentrates on the basic functions such as Start/Stop, fan control, temperature setting, and operation mode. Wire type: Non-polar 2-wire
	Simple remote controller	UTY-RHRY	Compact remote controller concentrates on the basic functions such as Start/Stop, fan control, and temperature setting. Wire type: Non-polar 2-wire
	Simple remote controller	UTY-RSNYM	Compact remote controller concentrates on the basic functions such as Start/Stop, fan control, temperature setting, and operation mode. Wire type: Polar 3-wire

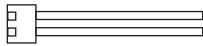
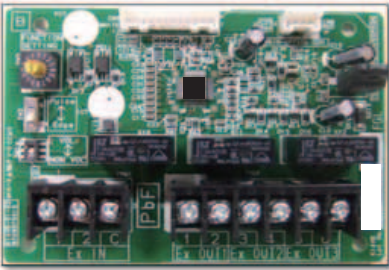
Exterior	Part name	Model name	Summary
	IR receiver kit with wireless remote controller	UTY-LBTYM	Unit control is performed by wireless remote controller.

NOTE: Available functions may differ by the remote controller. For details, refer to the operation manual.

14-2. Others

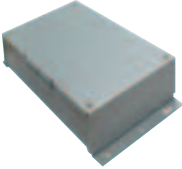
Exterior	Part name	Model name	Summary
	Remote sensor unit	UTY-XSZX	Thermo-sensor for sensing the temperature of arbitrary place in the room.
	Long-life filter	UTD-LFKA	Long-life filter can be mounted to the indoor unit.
	Drain pump unit	UTZ-PX1NAB	Optional drain lift up mechanism allows more flexible installation.
	External connect kit	UTY-XWZXZG	Use to connect with various peripheral devices and air conditioner PCB. For control output port.
	External input and output PCB	UTY-XCSX	Use to connect with external devices and air conditioner PCB.
	Wireless LAN adapter	UTY-TFSXZ1	Remotely manage an air conditioning system using mobile devices such as smartphones and tablets.
	Modbus converter	UTY-VMSX	For connection between an air conditioner and a Modbus open network.
	KNX converter	UTY-VKSX	For connection between an air conditioner and a KNX network.
	Split system converter	UTY-VTGX	This converter is required when connecting single split system to VRF network system.

Exterior	Part name	Model name	Summary
	Split system converter (AC power supply)	UTY-VTGXV	This converter is required when connecting single split system to VRF network system.
	External switch controller	UTY-TERX	Air conditioner switching can be controlled by connecting other external sensor switches.

NOTE: Combined use of External input and output PCB, Modbus converter, KNX converter, , and Wireless LAN adapter is not allowed.