

EEV internal model

AS*A004GCGH
AS*A007GCGH
AS*A009GCGH
AS*A012GCGH
AS*A014GCGH

EEV external model

AS*E004GCEH
AS*E007GCEH
AS*E009GCEH
AS*E012GCEH
AS*E014GCEH

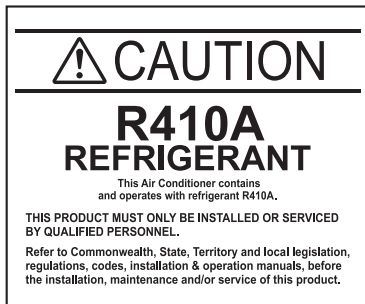

Refer to the rating label for the serial number, manufactured year and month.

FUJITSU GENERAL LIMITED

INSTALLATION MANUAL

INDOOR UNIT (Wall mounted type)

For authorized service personnel only.

English

INSTALLATIONSANLEITUNG

INNENGERÄT (wandmontierter Typ)

Nur für autorisiertes Fachpersonal.

Deutsch

MANUEL D'INSTALLATION

UNITÉ INTÉRIEURE (Type montage mural)

Pour le personnel agréé uniquement.

Français

MANUAL DE INSTALACIÓN

UNIDAD INTERIOR (Tipo montado en pared)

Únicamente para personal de servicio autorizado.

Español

MANUALE DI INSTALLAZIONE

UNITÀ INTERNA (tipo montato a parete)

A uso esclusivo del personale tecnico autorizzato.

Italiano

ΕΓΧΕΙΡΙΔΙΟ ΕΓΚΑΤΑΣΤΑΣΗΣ

ΕΣΩΤΕΡΙΚΗ ΜΟΝΑΔΑ (Επιτοίχιος Τύπος)

Μόνο για εξουσιοδοτημένο τεχνικό προσωπικό.

Ελληνικά

MANUAL DE INSTALAÇÃO

UNIDADE INTERIOR (Tipo mural)

Apenas para técnicos autorizados.

Português

РУКОВОДСТВО ПО УСТАНОВКЕ

ВНУТРЕННИЙ МОДУЛЬ (настенного типа)

Только для авторизованного обслуживающего персонала.

Русский

MONTAJ KILAVUZU

İÇ ÜNİTE (Duvara Monteli Tip)

Yalnızca yetkili servis personeli için.

Türkçe

MADE IN P.R.C.

[Original instructions]



PART No. 9373370482

INSTALLATION MANUAL

PART No. 9373370482

VRF system indoor unit (Wall mounted type)

Contents

1. SAFETY PRECAUTIONS	1
2. ABOUT THIS PRODUCT	1
2.1. Precautions for using the R410A refrigerant	1
2.2. Special tools for R410A	1
2.3. Accessories	2
2.4. Optional parts	2
3. INSTALLATION WORK	2
3.1. Selecting an installation location	2
3.2. Installation dimension	3
3.3. Installing the unit	3
4. PIPE INSTALLATION	4
4.1. Selecting the pipe material	4
4.2. Pipe requirement	4
4.3. Flare connection (pipe connection)	4
5. ELECTRICAL WIRING	5
5.1. Electrical requirement	5
5.2. Wiring method	6
5.3. Unit wiring	6
5.4. Wiring	7
6. FIELD SETTING	7
6.1. Setting the address	7
6.2. Custom code setting	7
6.3. Function setting	8
6.4. Optional parts wiring	9
6.5. External input and external output (Optional parts)	9
7. FINISHING	11
7.1. Connection pipe, cable and drain hose	11
8. FRONT PANEL REMOVAL AND INSTALLATION	11
8.1. Intake grille removal and installation	11
8.2. Front panel removal	11
8.3. Front panel installation	12
9. TEST RUN	12
9.1. Test run using Outdoor unit (PCB)	12
9.2. Test run using remote controller	12
10. CHECK LIST	12
11. ERROR CODES	12

1. SAFETY PRECAUTIONS

- Be sure to read this Manual thoroughly before installation.
- The warnings and precautions indicated in this Manual contain important information pertaining to your safety. Be sure to observe them.
- Hand this Manual, together with the Operating Manual, to the customer. Request the customer to keep them on hand for future use, such as for relocating or repairing the unit.

⚠ WARNING	This mark indicates procedures which, if improperly performed, might lead to the death or serious injury of the user.
Request your dealer or a professional installer to install the indoor unit in accordance with this Installation Manual. An improperly installed unit can cause serious accidents such as water leakage, electric shock, or fire. If the indoor unit is installed in disregard of the instructions in the Installation Manual, it will void the manufacturer's warranty.	
Do not turn ON the power until all work has been completed. Turning ON the power before the work is completed can cause serious accidents such as electric shock or fire.	
If refrigerant leaks while work is being carried out, ventilate the area. If the refrigerant comes in contact with a flame, it produces a toxic gas.	
Installation work must be performed in accordance with national wiring standards by authorized personnel only.	
Except for EMERGENCY, never turn off main as well as sub breaker of the indoor units during operation. It will cause compressor failure as well as water leakage. First, stop the indoor unit by operating the controller, converter or external input device and then cut the breaker. Make sure to operate through the controller, converter or external input device. When the breaker is designed, locate it at a place where the users cannot start and stop in the daily work.	

⚠ CAUTION	This mark indicates procedures which, if improperly performed, might possibly result in personal harm to the user, or damage to property.
Read carefully all security information before use or install the air conditioner.	
Do not attempt to install the air conditioner or a part of the air conditioner by yourself.	
This unit must be installed by qualified personnel with a capacity certificate for handling refrigerant fluids. Refer to regulation and laws in use on installation place.	
The installation must be carried out in compliance with regulations in force in the place of installation and the installation instructions of the manufacturer.	
This unit is part of a set constituting an air conditioner. It must not be installed alone or with non-authorized by the manufacturer.	
Always use a separate power supply line protected by a circuit breaker operating on all wires with a distance between contact of 3 mm for this unit.	
The unit must be correctly earthed (grounded) and the supply line must be equipped with a differential breaker in order to protect the persons.	
The units are not explosion proof and therefore should not be installed in explosive atmosphere.	
Never touch electrical components immediately after the power supply has been turned off. Electric shock may occur. After turning off the power, always wait 5 minutes before touching electrical components.	
This unit contains no user-serviceable parts. Always consult authorized service personnel to repairs.	
When moving, consult authorized service personnel for disconnection and installation of the unit.	

2. ABOUT THIS PRODUCT

2.1. Precautions for using the R410A refrigerant

⚠ WARNING
Do not introduce any substance other than the prescribed refrigerant into the refrigeration cycle. If air enters the refrigeration cycle, the pressure in the refrigeration cycle will become abnormally high and cause the piping to rupture.
If there is a refrigerant leak, make sure that it does not exceed the concentration limit. If a refrigerant leak exceeds the concentration limit, it can lead to accidents such as oxygen starvation.
Do not touch refrigerant that has leaked from the refrigerant pipe connections or other area. Touching the refrigerant directly can cause frostbite.
If a refrigerant leak occurs during operation, immediately vacate the premises and thoroughly ventilate the area. If the refrigerant comes in contact with a flame, it produces a toxic gas.

2.2. Special tools for R410A

⚠ WARNING
To install a unit that uses R410A refrigerant, use dedicated tools and piping materials that have been manufactured specifically for R410A use. Because the pressure of R410A refrigerant is approximately 1.6 times higher than the R22, failure to use dedicated piping material or improper installation can cause rupture or injury. Furthermore, it can cause serious accidents such as water leakage, electric shock, or fire.









Tool name	Contents of change for R22 tool
Gauge manifold	Pressure is huge and cannot be measured with a conventional gauge. To prevent erroneous mixing of other refrigerants, the diameter of each port has been changed. It is recommended to use a gauge manifold with a high pressure display range -0.1 to 5.3 MPa and a low pressure display range -0.1 to 3.8 MPa.
Charging hose	To increase pressure resistance, the hose material and base size were changed.
Vacuum pump	A conventional vacuum pump can be used by installing a vacuum pump adapter. <ul style="list-style-type: none"> • A conventional vacuum pump can be used by installing a vacuum pump adapter. • Be sure that the pump oil does not back flow into the system. Use one capable for vacuum suction of -100.7 kPa (5 Ton, -755 mmHg).
Gas leak detector	Special gas leak detector for HFC refrigerant R410A.

2.3. Accessories

⚠ WARNING

For installation purposes, be sure to use the parts supplied by the manufacturer or other prescribed parts. The use of non-prescribed parts can cause serious accidents such as the unit falling, water leakage, electric shock, or fire.

- The following installation parts are furnished. Use them as required.
- Keep the Installation Manual in a safe place and do not discard any other accessories until the installation work has been completed.

Name and Shape	Q'ty	Application
Operating Manual 	1	
Installation Manual 	1	(This book)
Operating Manual (CD-ROM) 	1	
Wall hook bracket 	1	For indoor unit installation.
Tapping screw (M4 × 25 mm) 	5	For wall hook bracket installation.
Cloth tape 	1	For indoor unit installation.
Seal A 	1	It is used when the diameter of gas pipe is $\varnothing 12.70$ or more. It is necessary when using AS012/014.
Air cleaning filter 	2	For installation, refer to the "CLEANING AND CARE" in the operating manual.
Air cleaning filter frame 	2	

2.4. Optional parts

Description	Model	Application
External connect kit	UTY-XWZXZC	For output function (Output terminal / CNB01)
	UTY-XWZXZB	For control input function (Apply voltage terminal / CNA01)
	UTY-XWZXZD	For control input function (Dry contact terminal / CNA02)
	UTY-XWZXZ7	For forced thermostat off function (Apply voltage terminal / CNA03)
	UTY-XWZXZE	For forced thermostat off function (Dry contact terminal / CNA04)
Wireless LAN adapter	UTY-TFSXZ*	For wireless LAN control.
External power supply unit	UTZ-GXXA	Supply power to the indoor unit PCB when the indoor unit is turned off to prevent errors.

3. INSTALLATION WORK

Correct initial installation location is important because it is difficult to move unit after it is installed.

3.1. Selecting an installation location

Decide the mounting position together with the customer as follows.

⚠ WARNING

Select installation locations that can properly support the weight of the indoor unit. Install the units securely so that they do not topple or fall.

⚠ CAUTION

Do not install the indoor unit in the following areas:

- Area with high salt content, such as at the seaside. It will deteriorate metal parts, causing the parts to fail or the unit to leak water.
- Area filled with mineral oil or containing a large amount of splashed oil or steam, such as a kitchen. It will deteriorate plastic parts, causing the parts to fail or the unit to leak water.
- Area that generates substances that adversely affect the equipment, such as sulfuric gas, chlorine gas, acid, or alkali. It will cause the copper pipes and brazed joints to corrode, which can cause refrigerant leakage.
- Area that can cause combustible gas to leak, contains suspended carbon fibers or flammable dust, or volatile flammables such as paint thinner or gasoline. If gas leaks and settles around the unit, it can cause a fire.
- Area where animals may urinate on the unit or ammonia may be generated.

Do not use the unit for special purposes, such as storing food, raising animals, growing plants, or preserving precision devices or art objects. It can degrade the quality of the preserved or stored objects.

Do not install where there is the danger of combustible gas leakage.

Do not install the unit near a source of heat, steam, or flammable gas.

Install the unit where drainage does not cause any trouble.

Install the indoor unit, power supply cable, transmission cable, and remote controller cable at least 1 m away from a television or radio receivers. The purpose of this is to prevent TV reception interference or radio noise. (Even if they are installed more than 1 m apart, you could still receive noise under some signal conditions.)

If children under 10 years old may approach the unit, take preventive measures so that they cannot reach the unit.

Take precautions to prevent the unit from falling.

- (1) Install the indoor unit on a place having a sufficient strength so that it withstands against the weight of the indoor unit.
- (2) The inlet and outlet ports should not be obstructed; the air should be able to blow all over the room.
- (3) Leave the space required to service the air conditioner.
- (4) Install the unit where connection to the outdoor unit (or RB unit) is easy.
- (5) Install the unit where the connection pipe can be easily installed.
- (6) Install the unit where the drain pipe can be easily installed.
- (7) Install the unit where noise and vibrations are not amplified.
- (8) Take servicing, etc., into consideration and leave the spaces. Also install the unit where the filter can be removed.
- (9) Do not install the unit where it will be exposed to direct sunlight.

Detection range of the human sensor

⚠ CAUTION

Do not hit or push the human sensor. This may lead to damage or malfunction.

Do not touch the human sensor. Any scratches or dirt may lead to incorrect detection.

Do not place large objects near the human sensor. Also keep heating units outside the sensor's detection area.

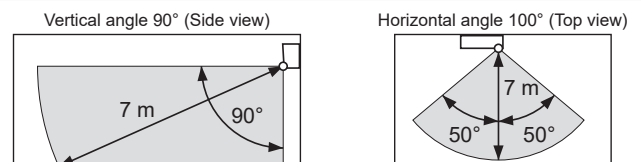

3.2. Installation dimension

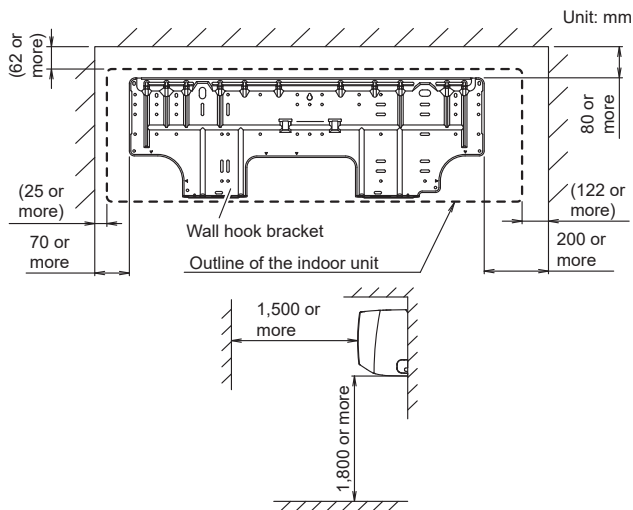

3.3. Installing the unit

⚠ WARNING

Install the air conditioner in a location which can withstand a load of at least 5 times the weight of the main unit and which will not amplify sound or vibration. If the installation location is not strong enough, the indoor unit may fall and cause injuries.

If the job is done with the panel frame only, there is a risk that the unit will come loose. Please take care.

3.3.1 Determining the piping direction

The piping can be connected according to the figure and table. When the piping is connected in direction (B), (C), (D) or (E), cut along the piping groove in the side of the front panel with a hacksaw.

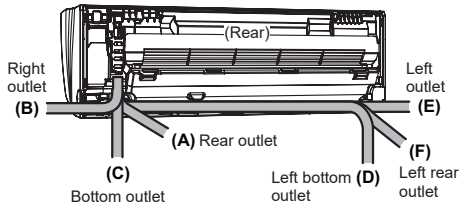

3.3.2 Installing the wall hook bracket

⚠ WARNING

Install the wall hook bracket level, both horizontally and vertically. If the wall hook bracket is tilted, water will drip to the floor.

As the weight of the indoor unit is 15 to 18 kg, it should be installed after properly examining the place where it is intended to be installed. If the place is not strong enough, a plank or girder should be used to make the place sufficiently strong so that the wall can support the weight.

- Remove the wall hook bracket from the indoor unit. (Remove 2 screws).
- Refer to figure below for the installation hole positions of the wall hook bracket.

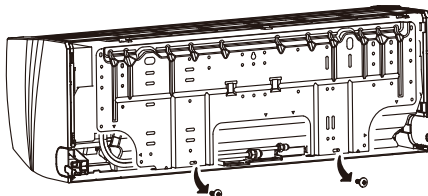

- Before fastening the wall hook bracket to the wall with the screws, level it by tapping the hook at the center of bracket to the wall with the handle of a screwdriver.

- Fasten the wall hook bracket to the wall with 5 or more screws and anchor bolts through the holes near the outer edge of the bracket. (Do not install the wall hook bracket at only 1 place or at an angle.)

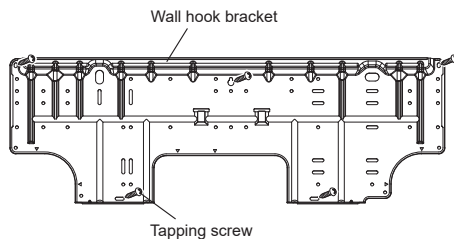

- For a concrete wall, embed anchor bolts (10 mm dia.) into the wall at the wall hook bracket holes. (Allow the anchor bolts to stick out at least 18 mm from the wall. Use 2 bolts for flat concrete wall and 4 bolts for blister concrete wall.)
- Install the nuts to the anchor bolts through the wall hook bracket.
- Finally tighten the bolts and wood screws after confirming, using the level indicator, that the clamp is horizontal.

3.3.3 Cutting the hole in the wall for the connecting piping

- Cut a hole in the wall at the position shown in the following.
- Cut the hole so that the outside end is lower (5 to 10 mm) than the inside end.
- Always align the center of the wall hole. If misaligned, water leakage will occur.
- Cut the wall pipe to match the wall thickness, stick it into the wall cap, fasten the cap with vinyl tape, and stick the pipe through the hole.
- For left piping and right piping, cut the hole a little lower so that drain water will flow freely.

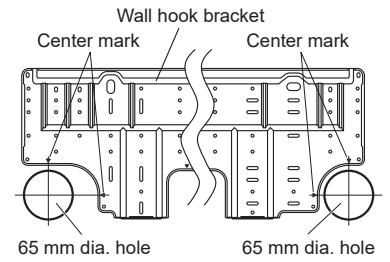

Attach the wall pipe

⚠ WARNING

If the wall pipe is not used, the cable interconnecting the indoor and outdoor units may touch metal and cause electric leakage.

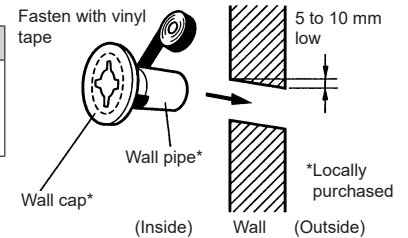

3.3.4 Forming the drain hose and pipe

⚠ CAUTION

Insert drain hose and drain cap securely. Drain should slope down to avoid water leakage.

When inserting the drain hose, no other material than water should be applied. Application of other material than water will cause deterioration of the hose, and may cause water leakage.

After you remove a drain hose, be sure to attach the drain cap.

When you secure the piping and drain hose with tape, arrange the drain hose so that it is at the bottom of the piping.

For drain hose piping in low temperature environment, you need to apply freeze protection to prevent a frozen drain hose.

After cooling operation is performed in low temperature environment, (when outdoor temperature under 0 °C,) water in the drain hose could be frozen. Frozen drain water will block the water flow in the hose, and may cause water leakage at the indoor unit.

[For (A) Rear piping, (B) Right piping and (C) Bottom piping]

- Install the indoor unit piping in the direction of the wall hole and bind the drain hose and pipe together with vinyl tape.
- Install the piping so that the drain hose is at the bottom.
- Wrap the pipe of the indoor unit that visible from the outside with decorative tape.
- For right or bottom outlet piping, cut off the piping outlet cutting groove with a hacksaw.

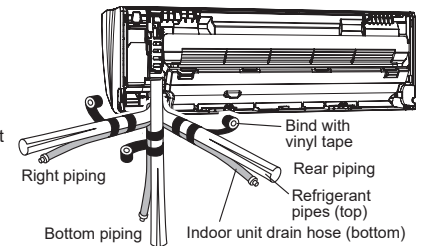

[For (D) Left bottom piping, (E) Left piping and (F) Left rear piping]

⚠ CAUTION

Insert the drain hose and drain cap into the drain port, making sure that it comes in contact with the back of the drain port, and then mount it. If the drain hose is not connected properly, leaking will occur.

- Interchange the drain cap and the drain hose.

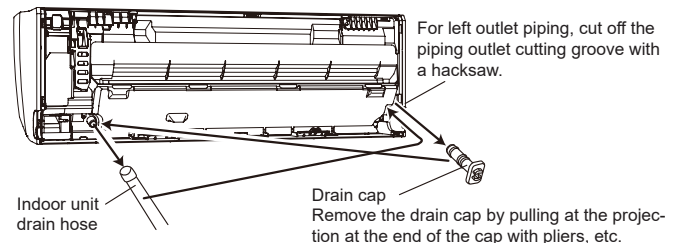

Drain hose removal and installation method

Removal	Installation
<p>Remove the screw at the left of drain hose and pull out drain hose.</p>	<p>Vertically insert the drain hose toward the inside, so that the drain fixture can accurately align with the screw hole around the drain cock. After inserting and before replacing, reinstall and fix the removed screws.</p>

Installing the drain cap

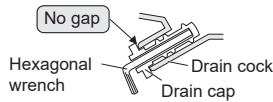

Use a hexagonal wrench 4 mm at opposite side to insert the drain cap, till the drain cap contacts the tip of drain cock.

- Align the marks on the wall hook bracket and shape the connection pipe. For left piping and left rear piping, align the marks on the wall hook bracket and shape the connection pipe.
- Bend the connection piping at the bend radius of 70 mm or more and install no more than 35 mm from the wall.

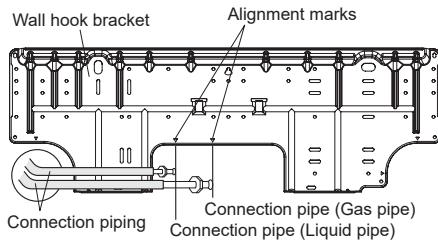

3.3.5 Installing the indoor unit

- After passing the indoor piping and drain hose through the wall hole, hang the indoor unit on the hooks at the top and bottom of the wall hook bracket. After hooking the indoor unit to the top hook, hook the fittings of the indoor unit to the 2 bottom hooks while lowering the unit and pushing it against the wall.

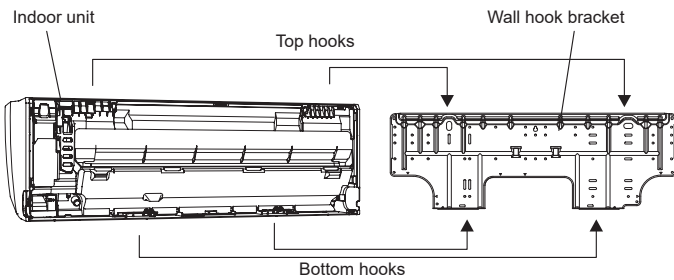

- Insert the spacer, etc. between the indoor unit and the wall hook bracket and separate the bottom of the indoor unit from the wall.

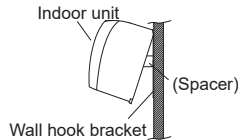

4. PIPE INSTALLATION

CAUTION

Be more careful that foreign matter (oil, water, etc.) does not enter the piping than with refrigerant R410A models. Also, when storing the piping, securely seal the openings by pinching, taping, etc.

While welding the pipes, be sure to blow dry nitrogen gas through them.

4.1. Selecting the pipe material

CAUTION

Do not use existing pipes from another refrigeration system or refrigerant.

Use pipes that have clean external and internal sides without any contamination which may cause trouble during use, such as sulfur, oxide, dust, cutting waste, oil, or water.

It is necessary to use seamless copper pipes.
Material: Phosphor deoxidized seamless copper pipes.
It is desirable that the amount of residual oil is less than 40 mg/10 m.

Do not use copper pipes that have a collapsed, deformed, or discolored portion (especially on the interior surface). Otherwise, the expansion valve or capillary tube may become blocked with contaminants.

Improper pipe selection will degrade performance. As an air conditioner using R410A incurs pressure higher than when using conventional (R22) refrigerant, it is necessary to choose adequate materials.

- Thicknesses of copper pipes used with R410A are as shown in the table.
- Never use copper pipes thinner than those indicated in the table even if they are available on the market.

Thicknesses of Annealed Copper Pipes (R410A)

Pipe outside diameter [mm (in)]	Thickness [mm]
6.35 (1/4)	0.80
9.52 (3/8)	0.80
12.70 (1/2)	0.80
15.88 (5/8)	1.00
19.05 (3/4)	1.20

4.2. Pipe requirement

CAUTION

Refer to the installation manual for the outdoor unit for description of allowable pipe length and height difference.

Use pipe with water-resistant heat insulation.

CAUTION

Install heat insulation around both the gas and liquid pipes. Failure to do so may cause water leaks.

Use heat insulation with heat resistance above 120 °C. (Reverse cycle model only)
In addition, if the humidity level at the installation location of the refrigerant piping is expected to exceed 70 %, install heat insulation around the refrigerant piping.
If the expected humidity level is 70 to 80 %, use heat insulation that is 15 mm or thicker and if the expected humidity exceeds 80 %, use heat insulation that is 20 mm or thicker.
If heat insulation is used that is not as thick as specified, condensation may form on the surface of the insulation.

In addition, use heat insulation with heat conductivity of 0.045 W/(m·K) or less (at 20 °C).

4.3. Flare connection (pipe connection)

WARNING

Tighten the flare nuts with a torque wrench using the specified tightening method. Otherwise, the flare nuts could break after a prolonged period, causing refrigerant to leak and generate hazardous gas if the refrigerant comes into contact with a flame.

4.3.1 Flaring

Use special flare tool exclusive for R410A.

- Cut the connection pipe to the necessary length with a pipe cutter.
- Hold the pipe downward so that cuttings will not enter the pipe and remove any burrs.
- Insert the flare nut (always use the flare nut attached to the indoor and outdoor units (or RB unit) respectively) onto the pipe and perform the flare processing with a flare tool. Use the special R410A flare tool. Leakage of refrigerant may result if other flare nuts are used.
- Protect the pipes by pinching them or with tape to prevent dust, dirt, or water from entering the pipes.

Check if [L] is flared uniformly and is not cracked or scratched.

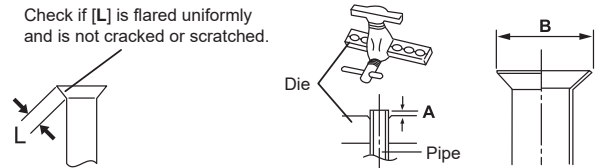

Pipe outside diameter [mm (in)]	Dimension A [mm]	Dimension B ± 0.4 [mm]
	Flare tool for R410A, clutch type	
6.35 (1/4)	0 to 0.5	9.1
9.52 (3/8)		13.2
12.70 (1/2)		16.6
15.88 (5/8)		19.7
19.05 (3/4)		24.0

When using conventional (R22) flare tools to flare R410A pipes, the dimension A should be approximately 0.5 mm more than indicated in the table (for flaring with R410A flare tools) to achieve the specified flaring. Use a thickness gauge to measure the dimension A. It is recommended that a R410A flaring tool is used.

Width across flats	Pipe outside diameter [mm (in)]	Width across flats of Flare nut [mm]
	6.35 (1/4)	17
	9.52 (3/8)	22
	12.70 (1/2)	26
	15.88 (5/8)	29
	19.05 (3/4)	36

4.3.2 Bending pipes

- The pipes are shaped by your hands or pipe bender. Be careful not to collapse them.
- Do not bend the pipes in an angle more than 90°.
- When pipes are repeatedly bend or stretched, the material will harden, making it difficult to bend or stretch them anymore. Do not bend or stretch the pipes more than 3 times.

CAUTION

To prevent breaking of the pipe, avoid sharp bends.

If the pipe is bent repeatedly at the same place, it will break.

4.3.3 Pipe connection

When the flare nut is tightened properly by your hand, hold the body side coupling with a separate spanner, then tighten with a torque wrench.

⚠ CAUTION	
Be sure to install the pipe against the port on the indoor unit and the outdoor unit correctly. If the centering is improper, the flare nut cannot be tightened smoothly. If the flare nut is forced to turn, the threads will be damaged.	
Do not remove the flare nut from the indoor unit pipe until immediately before connecting the connection pipe.	
Do not use mineral oil on flared part. Prevent mineral oil from getting into the system as this would reduce the lifetime of the units.	
Hold the torque wrench at its grip, keeping it at a right angle with the pipe, in order to tighten the flare nut correctly.	

Flare nut [mm (in)]	Tightening torque [N·m (kgf·cm)]
6.35 (1/4) dia.	16 to 18 (160 to 180)
9.52 (3/8) dia.	32 to 42 (320 to 420)
12.70 (1/2) dia.	49 to 61 (490 to 610)
15.88 (5/8) dia.	63 to 75 (630 to 750)
19.05 (3/4) dia.	90 to 110 (900 to 1,100)

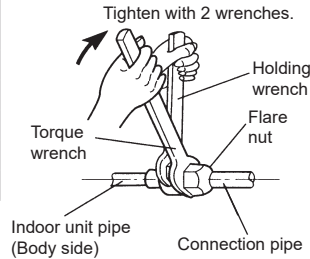

5. ELECTRICAL WIRING

⚠ WARNING	
Electrical work must be performed in accordance with this Manual by a person certified under the national or regional regulations. Be sure to use a dedicated circuit for the unit. An insufficient power supply circuit or improperly performed electrical work can cause serious accidents such as electric shock or fire.	
Before starting work, check that power is not being supplied to the all units.	
Use the included connection cables and power cables or ones specified by the manufacturer. Improper connections, insufficient insulation, or exceeding the allowable current can cause electric shock or fire.	
For wiring, use the prescribed type of cables, connect them securely, making sure that there are no external forces of the cables applied to the terminal connections. Improperly connected or secured cables can cause serious accidents such as overheating the terminals, electric shock, or fire.	
Do not modify the power cables, use extension cables, or use any branches in the wiring. Improper connections, insufficient insulation, or exceeding the allowable current can cause electric shock or fire.	
Match the terminal board numbers and connection cable colors with those of the outdoor unit (or RB unit). Erroneous wiring may cause burning of the electric parts.	
Securely connect the connection cables to the terminal board. In addition, secure the cables with wiring holders. Improper connections, either in the wiring or at the ends of the wiring, can cause a malfunction, electric shock, or fire.	
Always fasten the outside covering of the connection cable with the cable clamp. (If the insulator is chafed, electric discharge may occur.)	
Securely install the electrical box cover on the unit. An improperly installed electrical box cover can cause serious accidents such as electric shock or fire through exposure to dust or water.	
Install sleeves into any holes made in the walls for wiring. Otherwise, a short circuit could result.	
Install an earth leakage breaker. In addition, install the earth leakage breaker so that the entire AC main power supply is cut off at the same time. Otherwise, electric shock or fire could result.	
Always connect the earth (ground) cable. Improper earthing (grounding) work can cause electric shocks.	
Install the remote controller cables so as not to be direct touched with your hand.	
Perform wiring work in accordance with standards so that the air conditioner can be operated safely and positively.	
Connect the connection cable firmly to the terminal board. Imperfect installation may cause a fire.	
If the supply cable is damaged, it must be replaced by the manufacturer, its service agent or similarly qualified persons in order to avoid a hazard.	

⚠ CAUTION	
Earth (Ground) the unit. Do not connect the earth (ground) cable to a gas pipe, water pipe, lightning rod, or a telephone earth (ground) cable. Improper earthing (grounding) may cause electric shock.	
Do not connect power supply cable to the transmission or remote controller terminals, as this will damage the product.	
Never bundle the power supply cable and transmission cable, remote controller cable together. Separate these cable by 50 mm or more. Bundling these cables together will cause miss operation or breakdown.	
When handling PCB, static electricity charged in the body may cause malfunction of the PCB. Follow the cautions below: • Establish an earth (ground) for the indoor and outdoor units and peripheral devices. • Cut power (breaker) off. • Touch metal part of the indoor units for more than 10 seconds to discharge static electricity charged in the body. • Do not touch terminals of parts and patterns implemented on PCB.	

5.1. Electrical requirement

Voltage rating	230 V
Operating range	198 to 264 V (50 Hz) 198 to 253 V (60 Hz)

- Select the power cable type and size in accordance with relevant local and national regulations.
- Specifications for local wiring power cord and branch wiring are in compliance with local code.
- Max. wire length: Set a length so that the voltage drop is less than 2%. Increase the wire diameter when the wire length is long.

Breaker should be installed at every refrigerant system. Do not use a breaker in a different refrigerant system.

Refer to the table for the breaker specifications of each installation condition. Perform the power crossover wiring within the range of the same refrigerant system. When the crossover wiring is done, make a connection for indoor units to satisfy conditions A and B below.

A. Current breaker requirements

Model	MCA	MFA
AS*A004GCGH	0.15 A	20 A
AS*A007GCGH	0.20 A	
AS*A009GCGH	0.22 A	
AS*A012GCGH	0.30 A	
AS*A014GCGH	0.36 A	
AS*E004GCEH	0.15 A	
AS*E007GCEH	0.20 A	
AS*E009GCEH	0.22 A	
AS*E012GCEH	0.30 A	
AS*E014GCEH	0.36 A	

- MCA: Minimum Circuit Ampacity
- MFA: Maximum Fuse Ampacity

When the power crossover wiring is done, make it so that the total of the MCA of the connected RB units and indoor units does not exceed the 15 A. For RB unit MCA, refer to the RB unit installation manual.

If the capacity of connected RB units and indoor units exceeds the upper limit, either add breakers or use a breaker with a greater capacity.

B. Earth leakage breaker requirements

Breaker capacity	Maximum connectable "indoor units" or "indoor units + RB units" (*1)
30 mA, 0.1 s or less	44 or less (*2)
100 mA, 0.1 s or less	45 to 148

- *1: Heat pump type: indoor units, Heat recovery type: indoor units and RB units.
- *2: If the total number of units connected to the breaker exceeds 44, either add a 30mA breaker, or use breakers with a greater capacity.

5.1.1 Cable specifications

	Recommended cable size (mm ²)	Cable type	Remark
Power supply cable	2.5	Type 60245 IEC 57 or equivalent	2 Cable + earth (ground)
Transmission cable	0.33	LONWORKS compatible cable	22 AWG LEVEL 4 (NEMA) non-polar 2 core, twisted pair solid core diameter 0.65 mm
Remote controller cable (2-wire type)	0.33 to 1.25	Sheathed PVC cable *1	Non-polar 2 core, twisted pair

*1: Use shielded cable in accordance with local rules for remote controller cable.

5.2. Wiring method

Example

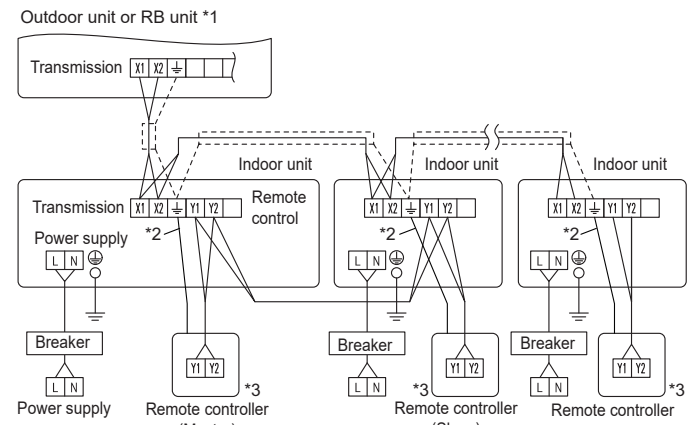

*1: When connecting to the Heat Recovery System, refer to the installation manual of the RB unit.

*2: Earth (Ground) the remote controller if it has an earth (ground) cable.

*3: The 3-wire type remote controller is not used.

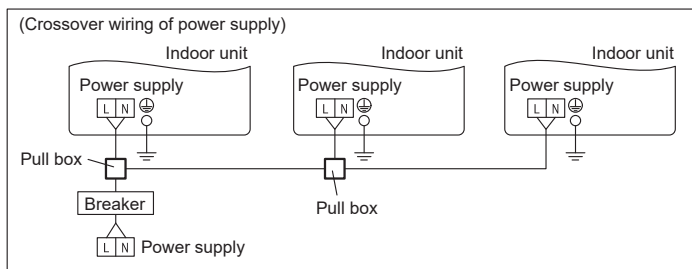

5.3. Unit wiring

• Before attaching the cable to terminal block.

5.3.1 Power supply cable

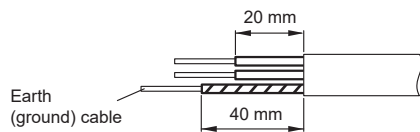

A. For solid core wiring

- To connect the electrical terminal, follow the below diagram and connect after looping it around the end of the cable.
- Use the specified cables, connect them securely, and fasten them so that there is no stress placed on the terminals.
- Use an appropriate screwdriver to tighten the terminal screws. Do not use a screwdriver that is too small, otherwise, the screw heads may be damaged and prevent the screws from being properly tightened.
- Do not tighten the terminal screws too much, otherwise, the screws may break.
- See the table for the terminal screw tightening torques.
- Please do not fix 2 power supply cables with 1 screw.

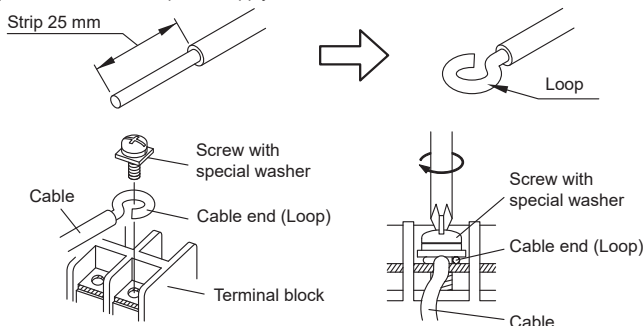

⚠ WARNING

When using solid core cables, do not use the attached ring terminal. If you use the solid core cables with the ring terminal, the ring terminal's pressure bonding may malfunction and cause the cables to abnormally heat up.

B. For strand wiring

- Use ring terminals with insulating sleeves as shown in the figure below to connect to the terminal block.
- Securely clamp the ring terminals to the cables using an appropriate tool so that the cables do not come loose.
- Use the specified cables, connect them securely, and fasten them so that there is no stress placed on the terminals.
- Use an appropriate screwdriver to tighten the terminal screws. Do not use a screwdriver that is too small, otherwise, the screw heads may be damaged and prevent the screws from being properly tightened.
- Do not tighten the terminal screws too much, otherwise, the screws may break.
- See the table for the terminal screw tightening torques.
- Please do not fix 2 power supply cables with 1 screw.

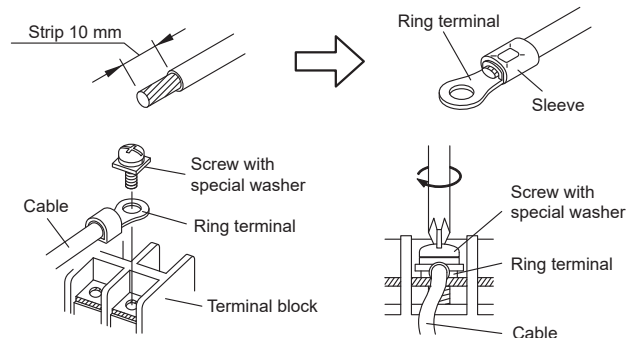

⚠ WARNING

Use ring terminals and tighten the terminal screws to the specified torques, otherwise, abnormal overheating may be produced and possibly cause heavy damage inside the unit.

Terminal number	Tightening torque
M4 screw (Power supply/L, N, GND)	1.2 to 1.8 N·m (12 to 18 kgf·cm)

5.3.2 Transmission and Remote controller cable

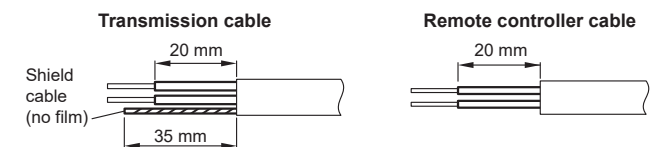

• Connect remote controller and transmission cables as shown in figure below.

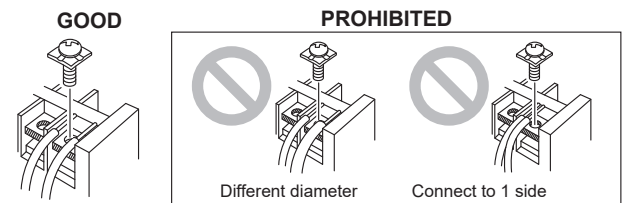

⚠ WARNING

Tighten the terminal screws to the specified torques, otherwise, abnormal overheating may be occurred and possibly cause serious damage inside the unit.

Tightening torque	
M3 screw (Transmission /X1, X2) (Remote controller /Y1, Y2)	0.5 to 0.6 N·m (5 to 6 kgf·cm)

⚠ CAUTION

To peel the sheath from the lead cable, use a dedicated tool that will not damage the conductor cable.

When installing a screw on the terminal block, do not cut the wire by overtightening the screw. On the other hand, an under tightened screw can cause faulty contact, which will lead to a communication failure.

5.4. Wiring

- Open the intake grille. Refer to "8. FRONT PANEL REMOVAL AND INSTALLATION".
- Remove the wire cover and remove the cable clamp.
- Connect the end of the connection cable fully into the terminal block.

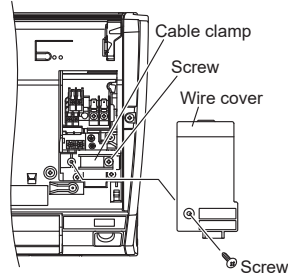

Symbol	Connection cable
A L	Power supply cable
B N	
C ⊕	Earth (ground) for power supply cable
D	Earth (ground) for transmission cable, wired remote controller cable (if necessary) and EV kit cable (EEV external model only)
E X1	Transmission cable
F X2	
G Y1	Wired remote controller cable (nonpolar)
H Y2	

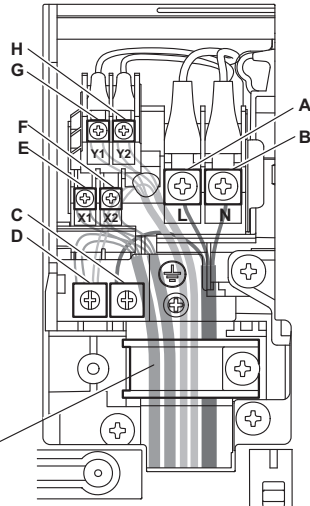

Cable clamp
(Clamp only the power supply cable)

EV kit cable connecting (EEV external model only)

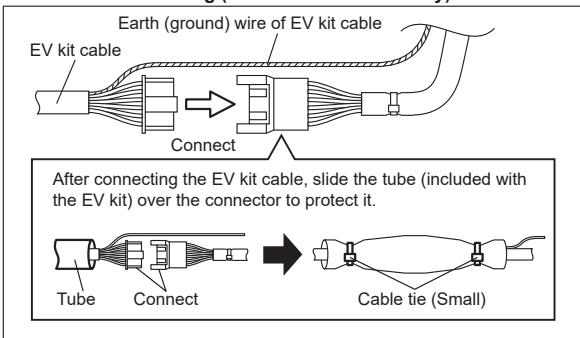

When you attach the cable clamp, make sure that the cables are not jutting out from the clamp or being pinched by the clamp.

6. FIELD SETTING

There are 3 methods for address setting by FIELD SETTING as follows. Please set by either of the methods. Each setting method is described in below (1) to (3).

- IU AD, REF AD SW settings: This section (6.1. Setting the address)
- Remote controller settings: Refer to the wired or wireless remote controller manual for detailed setting information. (Set IU AD, REF AD SW to 0)
- Automatic address settings: Refer to the outdoor unit manual for detailed setting information. (Set IU AD, REF AD SW to 0)

6.1. Setting the address

Manual address setting method

The indoor unit address and the refrigerant system address can also be set up through the wireless remote controller

⚠ CAUTION

Be sure to turn OFF the power before performing the field setting.

- Position and detail of the switches

You need to remove the front panel. Refer to "8. FRONT PANEL REMOVAL AND INSTALLATION".

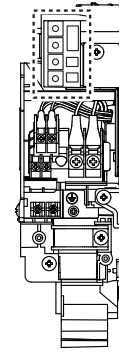

For refrigerant system address

For indoor unit address

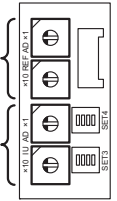

- Please set it according to the following procedures when setting manually.

⚠ CAUTION

Use an insulated screwdriver to set the dip switches.

Be careful not to make mistakes for switch settings.

6.1.1 Indoor unit address





- Rotary switch (IU AD × 1)...Factory setting "0"
- Rotary switch (IU AD × 10)...Factory setting "0"

When connecting multiple indoor units to 1 refrigerant system, set the address at IU AD SW as shown in the Table A

6.1.2 Refrigerant system address

- Rotary switch (REF AD × 1)...Factory setting "0"
- Rotary switch (REF AD × 10)...Factory setting "0"

In the case of multiple refrigerant systems, set REF AD SW as shown in the Table A for each refrigerant system. Set to the same refrigerant system address as the outdoor unit.

Setting	Setting range	Type of switch
Indoor unit address	0 to 63	Setting example: 2  IU AD × 10  IU AD × 1
Refrigerant system address	0 to 99	Setting example: 63  REF AD × 10  REF AD × 1

- If working in an environment where the wireless remote controller can be used, the addresses can also be set using the remote controller.
- If setting the addresses using the wireless remote controller, set the indoor unit address and refrigerant system address to "00". (For information on setting using the wireless remote controller.)

- * Do not set the indoor unit address (IU AD SW) at 64 to 99. It may result in failure.

Table A

Refrigerant system	Rotary switch setting		Address	Rotary switch setting	
	REF AD SW × 10	REF AD SW × 1		Indoor unit	IU AD SW × 10
0	0	0	0	0	0
1	0	1	1	0	1
2	0	2	2	0	2
3	0	3	3	0	3
4	0	4	4	0	4
5	0	5	5	0	5
⋮	⋮	⋮	⋮	⋮	⋮
10	1	0	10	1	0
11	1	1	11	1	1
⋮	⋮	⋮	⋮	⋮	⋮
99	9	9	63	6	3

6.2. Custom code setting

- Selecting the custom code prevents the indoor unit mix-up. (figure below) (Up to 4 codes can be set.)
- Perform the setting for both the indoor unit and the remote controller.

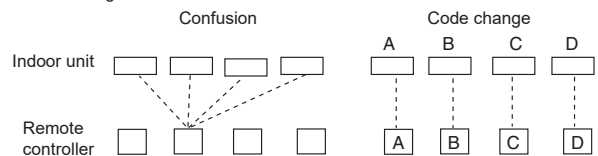

• Custom code setting for indoor unit

Set the DIP switch SET3 SW1, 2, referring to the figure and table below.

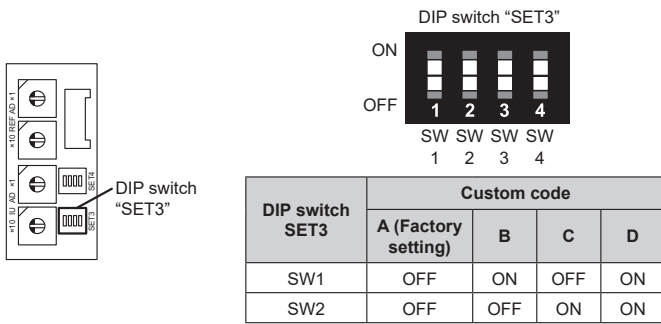

6.3. Function setting

⚠ WARNING

Please make this setting after completing all construction works.

- FUNCTION SETTING can be performed with the wired or wireless remote controller. (The remote controller is optional equipment)
- Refer to the wired or wireless remote controller manual for detailed setting information.
- Refer to "6.1. Setting the address" for indoor unit address and refrigerant system address settings.
- Turn the power of the indoor unit ON before starting the setting.

- * Turning on the power to the indoor units initializes EEV, so make sure the piping air tightness test and vacuuming have been conducted before turning on the power.
- * Also check again to make sure no wiring mistakes were made before turning on the power.

Function details

Function	Function number	Setting number	Default	Details
Filter indicator interval	11	00 Standard	○	Adjust the filter cleaning interval notification. If the notification is too early, change to setting 01. If the notification is too late, change to setting 02.
		01 Longer		
		02 Shorter		
Filter indicator action	13	00 Enable	○	Enable or disable the filter indicator. Setting 02 is for use with a central remote controller.
		01 Disable		
		02 Display only on central remote controller		
(Prohibited)	20		○	
(Prohibited)	23		○	
(Prohibited)	24		○	
(Prohibited)	26		○	
(Prohibited)	27		○	
Cool air temperature trigger	30	00 Standard	○	Adjust the cool air trigger temperature. To lower the trigger temperature, use setting 01. To raise the trigger temperature, use setting 02.
		01 Adjust (1)		
		02 Adjust (2)		
Heat air temperature trigger	31	00 Standard	○	Adjust the heat air trigger temperature. To lower the trigger temperature by 6 degrees C, use setting 01. To lower the trigger temperature by 4 degrees C, use setting 02. To raise the trigger temperature, use setting 03.
		01 Adjust (1)		
		02 Adjust (2)		
		03 Adjust (3)		
Auto restart	40	00 Enable	○	Enable or disable automatic system restart after a power outage.
		01 Disable		
Cool Air Prevention	43	00 Super low	○	Restrain the cold airflow with making the airflow lower when starting heating operation. To correspond to the ventilation, set to 01.
		01 Follow the setting on the remote controller		
External control	46	00 Start/Stop	○	Allow an external controller to start or stop the system, or to perform an emergency stop. * If an emergency stop is performed from an external controller, all refrigerant systems will be disabled. * If forced stop is set, indoor unit stops by the input to the external input terminals, and Start/Stop by a remote controller is restricted.
		01 Emergency stop		
		02 Forced stop		
Error report target	47	00 All	○	Change the target for reporting errors. Errors can either be reported in all locations, or only on the central remote controller.
		01 Display only on central remote controller		
Fan setting when cooling thermostat OFF	49	00 Follow the setting on the remote controller	○	When set to 01, the fan stops when the thermostat is OFF in cooling operation. Connection of the wired remote controller (2-wire type or 3-wire type) and switching its thermostat are necessary.
		01 Stop		

Function	Function number	Setting number	Default	Details
Switching function for external inputs	60	00 Forced thermostat off	○	Setting is required when connecting a refrigerant-leak detecting device. (only for J-IIIIL Series and J-IV Series)
		01		
		02		
		03		
		04	(Prohibited)	
		05		
		06		
		07		
		08		
		09 Refrigerant leak detection		
(Prohibited)	61	00	○	
(Prohibited)	62	00	○	
Auto mode type	68	00 Single setpoint auto mode (traditional)	○	Switch the setting method of auto mode to single or dual (cooling/heating). For heat pump systems, it is necessary to set the master indoor unit (by wired remote controller).
		01 Dual setpoint auto mode		
Deadband value	69	00 0 °C	○	Choose the minimum temperature between cooling and heating settings (deadband) for Dual setpoint auto mode (set in No. 68).
		01 0.5 °C		
		02 1.0 °C		
		03 1.5 °C		
		04 2.0 °C		
		05 2.5 °C		
		06 3.0 °C		
		07 3.5 °C		
		08 4.0 °C		
09 4.5 °C				
(Prohibited)	70	00	○	
(Prohibited)	72	00	○	
(Prohibited)	73	00	○	
(Prohibited)	74	00	○	
(Prohibited)	75	00	○	

6.3.1 Indoor unit indicator lamps

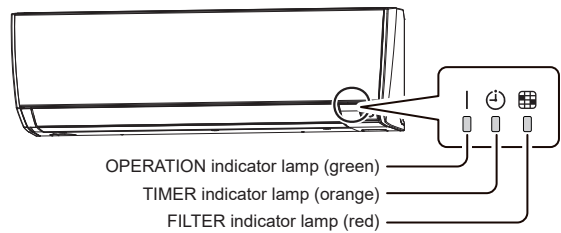

6.3.2 Checking the function settings

Press and hold the "MANUAL AUTO" button on the indoor unit for 3 seconds to check the function settings. It is necessary to disconnect the power in order to return to normal operation mode.

(1) Indoor unit and refrigerant address indication

Indication pattern

Indicator name	Indication pattern	
	Indoor unit address	Refrigerant address
OPERATION indicator lamp (Green)	ON	Blink (1.0 s ON/1.0 s OFF)
TIMER indicator lamp (Orange)	Address: tens place (0.5 s ON/0.5 s OFF)	
FILTER indicator lamp (Red)	Address: ones place (0.5 s ON/0.5 s OFF)	

(Example) Indoor unit address: 24

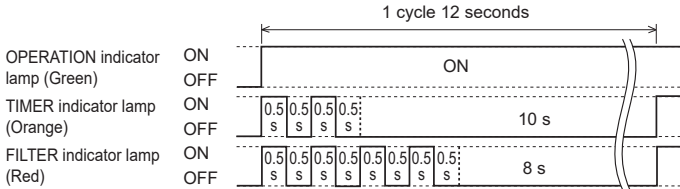

(Example) Refrigerant address: 30

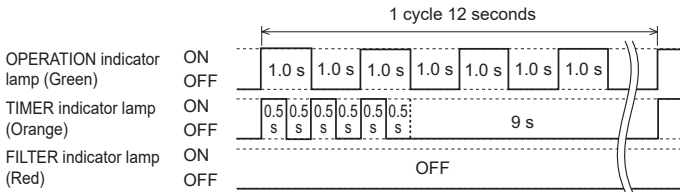

Setting details

Function number	Item	Setting number
01	Indoor unit address	00 to 63
02	Refrigeration address	00 to 99

For use with a remote controller, set all rotary switches to 0, and refer to "6.1. Setting the address" for details. All switches are set to 0 at the factory.

(2) Others

Indication pattern

Indicator Name	Indication pattern
OPERATION indicator lamp (Green)	Function number; tens place (0.5 s ON/0.5 s OFF)
TIMER indicator lamp (Orange)	Function number; ones place (0.5 s ON/0.5 s OFF)
FILTER indicator lamp (Red)	Setting number: (0 to 9) (0.5 s ON/0.5 s OFF)

(Example) Function number: 31, Setting number: 2

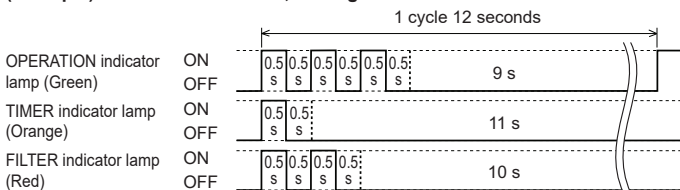

6.4. Optional parts wiring

In this setting, you need to remove the front panel. Refer to "8. FRONT PANEL REMOVAL AND INSTALLATION".

6.4.1. Layout of the indoor unit PCB

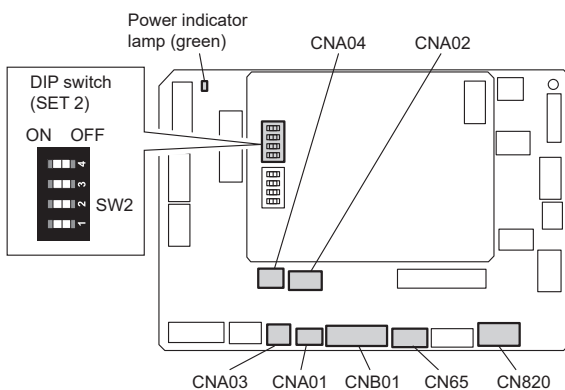

Name	Application	
CNA01	Apply voltage terminal	For external input
CNA03		
CNA02	Dry contact terminal	
CNA04		
DIP switch SET 2 (SW2)	Input signal type switching	
CNB01	Output terminal	For external output
CN65	For one of the following. • Modbus® converter (*1) • Wireless LAN adapter (*1)	
CN820	For External power supply unit (*1)	

*1: For details, refer to each installation manual.

6.4.2. Power indicator lamp status

Power indicator lamp (Green)	Status contents
○ Lit	Lit when the power is turned on.
● Fast blinking (every 0.1 second)	There is a fault with the communication board or the main board.
● Blinking (repeat 3 seconds ON and 1 second OFF)	The indoor unit is turned off and power is supplied from the External power supply unit (optional) to the indoor unit PCB.

6.4.3. Connection methods

Wire modification for External input/output wire

- Remove insulation from wire attached to wire kit connector.
- Remove insulation from field supplied cable. Use crimp type insulated butt connector to join field cable and wire kit wire.
- Connect the wire with connecting wire with solder.

IMPORTANT:

Be sure to insulate the connection between the wires.

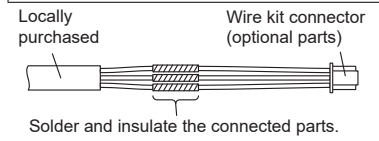

Wiring arrangement

In following figure, all the possible connectors are connected for description. In actual installation, you cannot connect all the connectors at once.

- Hang the wire on the hooks.
- After attaching the cover, push the wire into the gap.

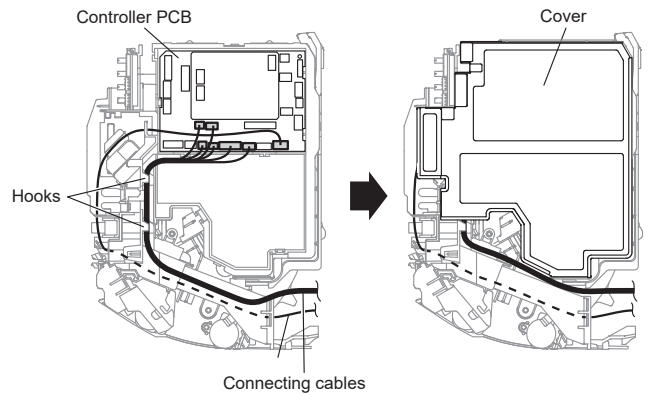

6.5. External input and external output (Optional parts)

6.5.1 External input

- Indoor unit can be Operation/Stop, Emergency stop or Forced stop by using indoor unit PCB CNA01 or CNA02.
- "Operation/Stop" mode, "Emergency stop" mode or "Forced stop" mode can be selected with function setting of indoor unit.
- Indoor unit can be Forced thermostat off by using indoor unit PCB CNA03 or CNA04.
- A twisted pair cable (22 AWG) should be used. Maximum length of cable is 150 m.
- Use an external input and output cable with appropriate external dimension, depending on the number of cables to be installed.
- The wire connection should be separate from the power cable line.

Input select

Use either one of these types of terminal according to the application. (Both types of terminals cannot be used simultaneously.)

• Apply voltage terminal ([CNA01], [CNA03])

When a power supply must be provided at the input device you want to connect, use the Apply voltage terminal ([CNA01], [CNA03]).

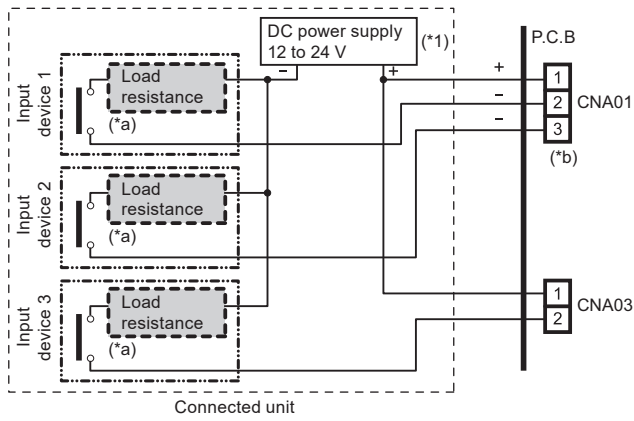

- *1: Make the power supply DC 12 to 24 V. Select a power supply capacity with an ample surplus for the connected load.
Do not impress a voltage exceeding 24 V across pins 1-2, and 1-3.
- *a: The allowable current is DC 5 mA to 10 mA. (Recommended: DC 5 mA)
Provide a load resistance such that the current becomes DC 10 mA or less.
Select very low current use contacts (usable at DC 12 V, DC 1 mA or less).
- *b: The polarity is [+] for pin 1 and [-] for pin 2 and 3. Connect correctly.

When connected to Apply voltage terminals of multiple indoor units with a connected unit, be sure to make a branch outside the indoor unit using a pull box, etc. as shown on below example.

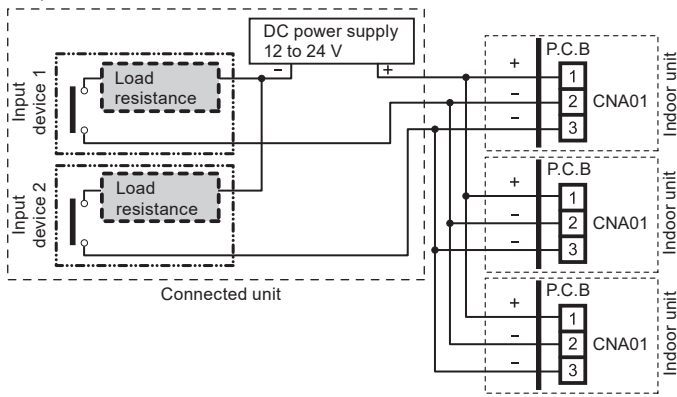

• Dry contact terminal ([CNA02], [CNA04])

When a power supply is unnecessary at the input device you want to connect, use the Dry contact terminal ([CNA02], [CNA04]).

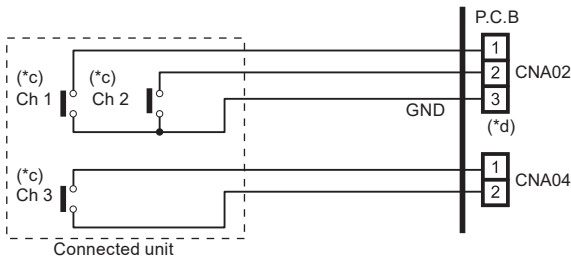

- *c: Select very low current use contacts (usable at DC 12 V, DC 1 mA or less).
- *d: The wiring is different from Apply voltage terminals. Be sufficiently careful when wiring.

When connected to Dry contact terminals of multiple indoor units with a connected unit, insulate each indoor unit with relay, etc. as shown on below example.

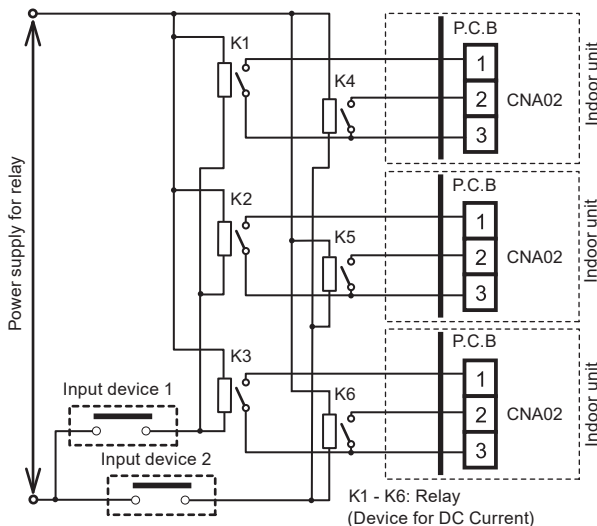

NOTE :

When connected to multiple indoor units directly, it will cause breakdown.

Operation behavior

• Input signal type

The input signal type can be selected.
It is switched by DIP switch on the indoor unit PCB.

DIP switch [SET2 SW2]	Input signal type
OFF (Factory setting)	Edge
ON	Pulse

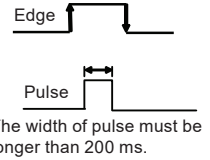

• When function setting is "Operation/Stop" mode.

[In the case of "Edge" input]

Connector	Input signal	Command
Ch1 of CNA01 or CNA02	OFF → ON	Operation
	ON → OFF	Stop

[In the case of "Pulse" input]

Connector	Input signal	Command	
CNA01 or CNA02	Ch1	OFF → ON	Operation
	Ch2	OFF → ON	Stop

* The last command has priority.

* The indoor units within the same remote controller group operates in the same mode.

• When function setting is "Emergency stop" mode.

[In the case of "Edge" input]

Connector	Input signal	Command
Ch1 of CNA01 or CNA02	OFF → ON	Emergency stop
	ON → OFF	Normal

[In the case of "Pulse" input]

Connector	Input signal	Command	
CNA01 or CNA02	Ch1	OFF → ON	Emergency stop
	Ch2	OFF → ON	Normal

* All indoor units of same refrigerant system stops when Emergency stop operates.

• When function setting is "Forced stop" mode.

[In the case of "Edge" input]

Connector	Input signal	Command
Ch1 of CNA01 or CNA02	OFF → ON	Forced stop
	ON → OFF	Normal

[In the case of "Pulse" input]

Connector	Input signal	Command	
CNA01 or CNA02	Ch1	OFF → ON	Forced stop
	Ch2	OFF → ON	Normal

* When the forced stop is triggered, indoor unit stops and Operation/Stop operation by a remote controller is restricted.

* When forced stop function is used with forming a remote controller group, connect the same equipment to each indoor unit within the group.

• Selection method of functions

"Operation/Stop" mode or "Emergency stop" mode, "Forced stop" mode can be selected with function setting of indoor unit.

• Forced thermostat off function

["Edge" input only]

Function setting	Connector	Input signal	Command
60-00	Ch3 of CNA03 or CNA04	OFF → ON	Thermostat off
		ON → OFF	Normal

• Refrigerant leak detection function (only for J-III Series and J-IV Series)

["Edge" input only]

Function setting	Connector	Input signal	Command
60-09	Ch3 of CNA03 or CNA04	OFF → ON	No command
		ON → OFF	Refrigerant leak

6.5.2 External output

- A twisted pair cable (22AWG) should be used. Maximum length of cable is 25m.
- Use an external input and output cable with appropriate external dimension, depending on the number of cables to be installed.
- Output voltage: Hi DC12V±2V, Lo 0V.
- Permissible current: 50mA

Output select

• When indicator etc. are connected directly

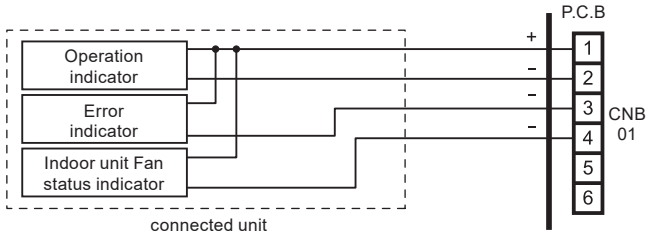

• When connecting with unit equipped with a power supply

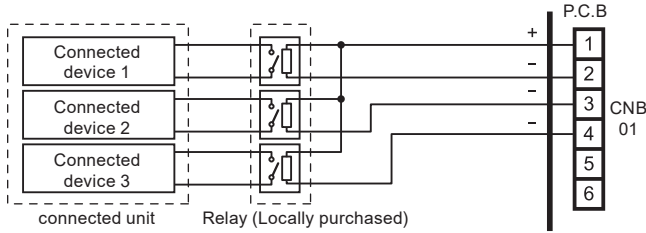

Operation behavior

Connector		Output voltage	Status
CNB01	External output 1 Pins 1-2	0V	Stop
		DC 12 V	Operation
	External output 2 Pins 1-3	0V	Normal
		DC 12 V	Error
	External output 3 Pins 1-4	0V	Indoor unit fan stop
		DC 12 V	Indoor unit fan operation

7. FINISHING

CAUTION

After checking for gas leaks (refer to the Installation Manual of the outdoor unit), perform this section.

Install heat insulation around both the large (gas) and small (liquid) pipes. Failure to do so may cause water leaks.

7.1. Connection pipe, cable and drain hose

Insulate the drain hose, if necessary, to prevent it from freezing.

(1) Insulate between pipes.

- For (A) Rear, (B) Right and (C) Bottom piping, overlap the connection pipe heat insulation and indoor unit pipe heat insulation and bind them with vinyl tape so that there is no gap.
- For (D) Left bottom piping, (E) Left piping, (F) Left rear piping, butt the connection pipe heat insulation and indoor unit pipe heat insulation together and bind them with vinyl tape so that there is no gap.

((A) Rear, (B) Right and (C) Bottom piping)

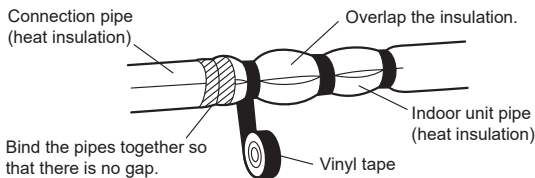

Seal A is used when the diameter of gas pipe is $\phi 12.70$ or more.



Butt connection pipe (heat insulation) against the indoor unit pipe (heat insulation) and wrap with seal A so that there is no gap.

(For (D) Left bottom piping, (E) Left piping, (F) Left rear piping)

- Wrap the area which accommodates the rear piping housing section with cloth tape.

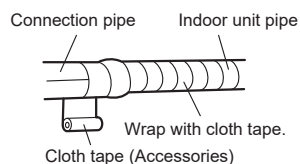

- Bind the connection cable with vinyl tape.
- Bundle the piping and drain hose together by wrapping them with cloth tape over the range within which they fit into the rear piping housing section.

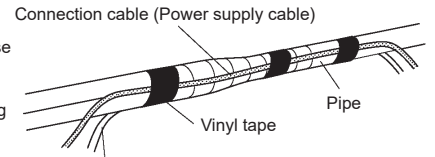

- (2) Temporarily fasten the connection cable along the connection pipe with vinyl tape.
- (3) Fasten the connection pipe to the outside wall with a saddle, etc.
- (4) Fill the gap between the outside wall pipe hole and the pipe with sealer so that rain water and wind cannot blow in.

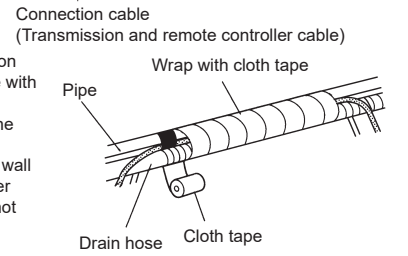

- (5) Fasten the drain hose to the outside wall, etc.

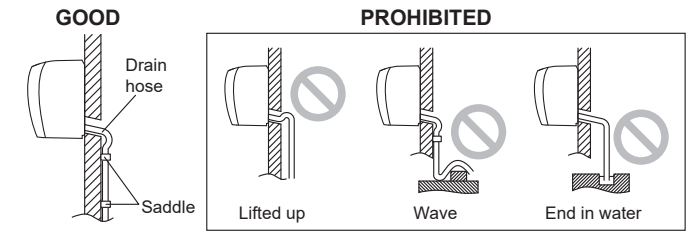
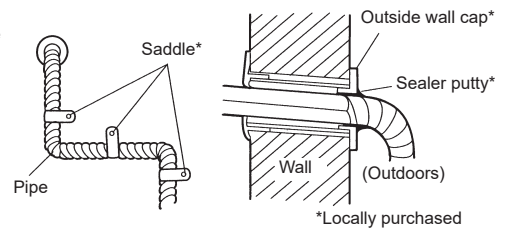

8. FRONT PANEL REMOVAL AND INSTALLATION

8.1. Intake grille removal and installation

Intake grille removal

Open the intake grille. While gently pressing the left and right mounting shafts of the intake grille outward "a", remove the intake grille in direction of the arrow "b".

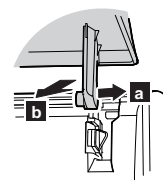

Intake grille installation

While holding the grille horizontal, set the left and right mounting shafts into the pillow blocks at the top of the panel "c". To latch each shaft properly, insert the shaft until it snaps.

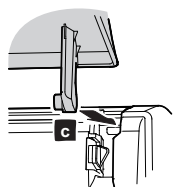

Press 4 places on the intake grille to close it completely.



8.2. Front panel removal

- (1) Remove intake grille (Reference the intake grille removal.)
- (2) Remove 3 caps.
- (3) Remove wire cover.
- (4) Remove 7 screws.

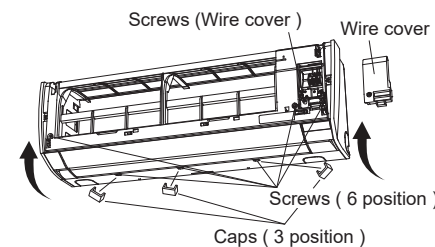

- (5) The front panel is pulled to the front, raising the upper surface, and a front panel is removed.

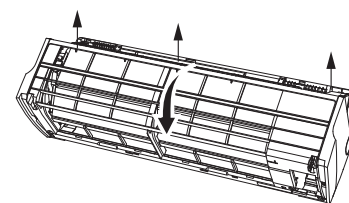

8.3. Front panel installation

- (1) First, fit the lower part of the front panel, and insert top and bottom hooks. (3 top sides, 2 center)

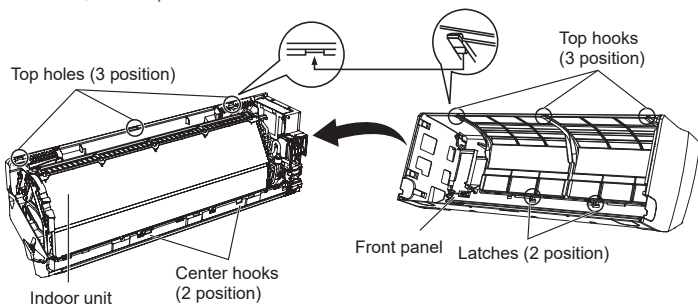

- (2) Attach the 6 screws.
 (3) Attach the wire cover.
 (4) Attach the 3 caps.
 (5) Attach the intake grille.

9. TEST RUN

9.1. Test run using Outdoor unit (PCB)

Refer to the Installation Manual for the outdoor unit if the PCB for the outdoor unit is to be used for the test run.

9.2. Test run using remote controller

- Refer to the Installation Manual for the remote controller to perform the test run using the remote controller.
- When the air conditioner is being test run, the OPERATION and TIMER indicator lamp flash slowly at the same time.

10. CHECK LIST

Pay special attention to the check items below when installing the indoor unit(s). After installation is complete, be sure to check the following check items again.

Check items	If not performed correctly	Check box
Has the indoor unit been installed correctly?	Vibration, noise, indoor unit may drop	
Has there been a check for gas leaks (refrigerant pipes)?	No cooling, No heating	
Has heat insulation work been completed?	Water leakage	
Does water drain easily from the indoor units?	Water leakage	
Is the voltage of the power source the same as that indicated on the label on the indoor unit?	No operation, heat or burn damage	
Are the wires and pipes all connected completely?	No operation, heat or burn damage	
Is the indoor unit earthed (grounded)?	Short circuit	
Is the connection cable the specified thickness?	No operation, heat or burn damage	
Are the inlets and outlets free of any obstacles?	No cooling, No heating	
Does start and stop air conditioner operation by remote controller or external device?	No operation	
After installation is completed, has the proper operation and handling been explained to the user?		

11. ERROR CODES

If you use a wired type remote controller, error codes will appear on the remote controller display. If you use a wireless remote controller, the lamp on the photodetector unit will output error codes by way of blinking patterns. See the lamp blinking patterns and error codes in the table below.

Error indications			Wired remote controller error code	Error contents
OPERATION lamp (green)	TIMER lamp (orange)	FILTER lamp (red)		
● (1)	● (2)	◇	12	Remote controller communication error
● (1)	● (4)	◇	14	Network communication error
● (1)	● (6)	◇	16	Peripheral unit communication error
● (2)	● (6)	◇	26	Indoor unit address setting error
● (2)	● (9)	◇	29	Connection unit number error in wired remote controller system
● (3)	● (1)	◇	31	Indoor unit power supply abnormal
● (3)	● (2)	◇	32	Indoor unit main PCB error
● (3)	● (10)	◇	3A	Indoor unit communication circuit (wired remote controller) error
● (4)	● (1)	◇	41	Indoor unit room temp. thermistor error
● (4)	● (2)	◇	42	Indoor unit heat ex. temp. thermistor error
● (4)	● (4)	◇	44	Human sensor error
● (5)	● (1)	◇	51	Indoor unit fan motor 1 error
● (5)	● (2)	◇	52	Indoor unit coil (expansion valve) error
● (5)	● (3)	◇	53	Indoor unit water drain abnormal
● (9)	● (15)	◇	9U	Outdoor unit miscellaneous error
● (10)	● (8)	◇	AB	Poor refrigerant circulation
● (13)	● (1)	◇	J1	RB unit error

Display mode ● : 0.5 s ON / 0.5 s OFF
 ◇ : 0.1 s ON / 0.1 s OFF
 () : Number of blinking

Wired remote controller display

UTY-RNR* (2-wire type)

Touch the [Error Information].

Touch the [Status].

Touch the [Next Page] (or [previous page]) to switch to other indoor unit information.

2-digit numbers are corresponding to the error code in the preceding table.

Error Code [14, 16]

For more information, refer to the installation manual of the remote controller.

UTY-RLR* (2-wire type)

Error code

For more information, refer to the installation manual of the remote controller.