

AIR CONDITIONER

Wall Mounted Type

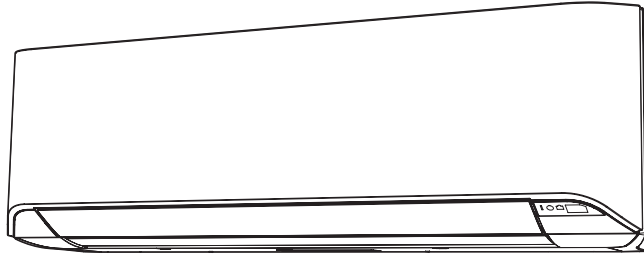

INSTALLATION MANUAL



PART No. 9333005225

English

Русский

Contents

1. SAFETY PRECAUTIONS.....	1
2. ABOUT THE PRODUCT.....	1
3. GENERAL SPECIFICATION	2
4. ELECTRICAL REQUIREMENT	2
5. SELECTING THE MOUNTING POSITION	2
6. INSTALLATION WORK	3
7. ELECTRICAL WIRING	5
8. FINISHING.....	5
9. FRONT PANEL REMOVAL AND INSTALLATION	6
10. REMOTE CONTROLLER INSTALLATION.....	6
11. OPTIONAL KIT INSTALLATION	6
12. FUNCTION SETTING.....	9
13. TEST RUN.....	10
14. CUSTOMER GUIDANCE	10
15. ERROR CODES.....	11

[Original instructions]

For authorized service personnel only.

1. SAFETY PRECAUTIONS

- Be sure to read this Manual thoroughly before installation.
- The warnings and precautions indicated in this Manual contain important information pertaining to your safety. Be sure to observe them.
- Hand this Manual, together with the Operating Manual, to the customer. Request the customer to keep them on hand for future use, such as for relocating or repairing the unit.

WARNING

Indicates a potentially or imminently hazardous situation which, if not avoided, could result in death or serious injury.

- Installation of this product must be done by experienced service technicians or professional installers only in accordance with this manual. Installation by non-professional or improper installation of the product might cause serious accidents such as injury, water leakage, electric shock, or fire. If the product is installed in disregard of the instructions in this manual, it will void the manufacturer's warranty.
- Do not turn on the power until all work has been completed. Turning on the power before the work is completed can cause serious accidents such as electric shock or fire.
- If refrigerant leaks when you are working, ventilate the area. If the leaking refrigerant is exposed to a direct flame, it may produce a toxic gas.
- Installation must be performed in accordance with regulations, codes, or standards for electrical wiring and equipment in each country, region, or the installation place.

CAUTION

Indicates a potentially hazardous situation that may result in minor or moderate injury or damage to property.

- Read carefully all safety information written in this manual before you install or use the air conditioner.
- Install the product by following local codes and regulations in force at the place of installation, and the instructions provided by the manufacturer.
- This unit must be installed by qualified personnel with a capacity certificate for handling refrigerant fluids. Refer to regulation and laws in use on installation place.
- This product is part of a set constituting an air conditioner. The product must not be installed alone or be installed with a device not authorized by the manufacturer.
- Always use a separate power supply line protected by a circuit breaker operating on all wires with a distance between contact of 3 mm for this product.
- To protect the persons, earth (ground) the product correctly, and use the power cable combined with an Earth Leakage Circuit Breaker (ELCB).
- This product is not explosion proof, and therefore should not be installed in an explosive atmosphere.
- To avoid getting an electric shock, never touch the electrical components soon after the power supply has been turned off. After turning off the power, always wait 5 minutes or more before you touch the electrical components.
- This product contains no user-serviceable parts. Always consult experienced service technicians for repairing.
- When moving or relocating the air conditioner, consult experienced service technicians for disconnection and reinstallation of the product.
- Do not touch the aluminum fins of heat exchanger built-in the indoor or outdoor unit to avoid personal injury when you install or maintain the unit.
- Do not place any other electrical products or household belongings under the product. Condensation dripping from the product might get them wet, and may cause damage or malfunction to the property.

2. ABOUT THE PRODUCT

2.1. Precautions for using R410A refrigerant

The basic installation work procedures are the same as conventional refrigerant (R22) models.
However, pay careful attention to the following points:

Since the working pressure is 1.6 times higher than that of conventional refrigerant (R22) models, some of the piping and installation and service tools are special. (See the table below.)

Especially, when replacing a conventional refrigerant (R22) model with a new refrigerant R410A model, always replace the conventional piping and flare nuts with the R410A piping and flare nuts.

Models that use refrigerant R410A have a different charging port thread diameter to prevent erroneous charging with conventional refrigerant (R22) and for safety. Therefore, check beforehand. [The charging port thread diameter for R410A is 1/2-20 UNF.]

Be more careful that foreign matter (oil, water, etc.) does not enter the piping than with refrigerant (R22) models. Also, when storing the piping, securely seal the opening by pinching, taping, etc.

When charging the refrigerant, take into account the slight change in the composition of the gas and liquid phases. And always charge from the liquid phase where refrigerant composition is stable.

2.2. Special tools for R410A

Tool name	Contents of change
Gauge manifold	Pressure is high and cannot be measured with a conventional (R22) gauge. To prevent erroneous mixing of other refrigerants, the diameter of each port has been changed. It is recommended the gauge with seals -0.1 to 5.3 MPa (-1 to 53 bar) for high pressure. -0.1 to 3.8 MPa (-1 to 38 bar) for low pressure.
Charge hose	To increase pressure resistance, the hose material and base size were changed.
Vacuum pump	A conventional vacuum pump can be used by installing a vacuum pump adapter.
Gas leakage detector	Special gas leakage detector for HFC refrigerant R410A.

Copper pipes

It is necessary to use seamless copper pipes and it is desirable that the amount of residual oil is less than 40 mg/10 m. Do not use copper pipes having a collapsed, deformed or discolored portion (especially on the interior surface). Otherwise, the expansion valve or capillary tube may become blocked with contaminants.

As an air conditioner using R410A incurs pressure higher than when using R22, it is necessary to choose adequate materials.

WARNING

Do not use the existing (for R22) piping and flare nuts.

If the existing materials are used, the pressure inside the refrigerant cycle will rise and cause failure, injury, etc. (Use the special R410A materials.)

When installing and relocating the air conditioner, do not mix gases other than the specified refrigerant (R410A) to enter the refrigerant cycle.

If air or other gas enters the refrigerant cycle, the pressure inside the cycle will rise to an abnormally high value and cause failure, injury, etc.

2.3. For authorized service personnel only

⚠ WARNING

- For the air conditioner to operate satisfactorily, install it as outlined in this installation manual.
- Connect the indoor unit and outdoor unit with the air conditioner piping and cables available from your local distributor. This installation manual describes the correct connections using the installation set available from your local distributor.
- Installation work must be performed in accordance with national wiring standards by authorized personnel only.
- Do not turn on the power until all installation work is complete.













⚠ CAUTION

This installation manual describes how to install the indoor unit only.
To install the outdoor unit, refer to the installation manual included with the outdoor unit.

- Be careful not to scratch the air conditioner when handling it.

2.4. Accessories

The following installation accessories are supplied. Use them as required.

Name and Shape	Q'ty	Name and Shape	Q'ty
Operating Manual 	1	Cloth tape 	1
Installation Manual (This manual) 	1	Seal A  It is used when the diameter of gas pipe is Ø12.70 or more. It is necessary when using AS14.	1
Wall hook bracket 	1	Tapping screws (large) 	5
Remote controller 	1	Tapping screws (small) 	2
Battery 	2	Air cleaning filter 	2
Remote controller holder 	1	Filter holders 	2

The following items are necessary to install this air conditioner. (The items are not included with the air conditioner and must be purchased separately.)

Name	Q'ty	Name	Q'ty
Connection pipe assembly	1	Wall cap	1
Connection cable (4-conductor)	1	Saddle	1 set
Wall pipe	1	Drain hose	1
Decorative tape	1	Tapping screws	1 set
Vinyl tape	1	Sealant	1

2.5. Optional parts

Refer to each installation manual for the method of installing optional parts.

Parts name	Model No.	Application
Wired Remote Controller *	UTY-RVN*M	For air conditioner operation
Wired Remote Controller *	UTY-RNN*M	For air conditioner operation
Simple Remote Controller *	UTY-RSN*M	For air conditioner operation
External connect kit *	UTY-XWZXZ5	For control input/output port
Communication kit	UTY-XCBXZ2	For the installation of optional parts

* Optional communication kit is necessary for the installation.

3. GENERAL SPECIFICATION

This INSTALLATION MANUAL briefly outlines where and how to install the air conditioning system. Please read over the entire set of instructions for the indoor and outdoor units and make sure all accessory parts listed are with the system before beginning.

3.1. Type of copper pipe and insulation material

⚠ CAUTION

Refer to the installation manual for the outdoor unit for description of allowable pipe length and height difference.

Model	Gas pipe size (thickness) [mm]	Liquid pipe size (thickness) [mm]
7, 9, 12	Ø 9.52 (0.8)	Ø 6.35 (0.8)
14	Ø 12.70 (0.8)	Ø 6.35 (0.8)

⚠ CAUTION

- Install heat insulation around both the gas and liquid pipes. Failure to do so may cause water leaks.
- Use heat insulation with heat resistance above 120 °C. Reverse cycle model only)
- In addition, if the humidity level at the installation location of the refrigerant piping is expected to exceed 70%, install heat insulation around the refrigerant piping. If the expected humidity level is 70-80%, use heat insulation that is 15 mm or thicker and if the expected humidity exceeds 80%, use heat insulation that is 20 mm or thicker.
- If heat insulation is used that is not as thick as specified, condensation may form on the surface of the insulation.
- In addition, use heat insulation with heat conductivity of 0.045 W/(m·K) or less 20 °C.

3.2. Additional materials required for installation

- A. Refrigeration (armored) tape
- B. Insulated staples or clamps for connecting wire (See your local electrical codes.)
- C. Putty
- D. Refrigeration lubricant
- E. Clamps or saddles to secure refrigerant piping

4. ELECTRICAL REQUIREMENT

The indoor unit is powered from the outdoor unit. Do not power indoor unit from separate power source.

⚠ WARNING

Refer to local codes for acceptable cable type.

Cable	Cable size	Remarks
Connection cable	Type 60245 IEC 57 (1.5 mm ²)	3 cable + Ground, 1.5 Ø 230 V

Cable Length: Limit voltage drop to less than 2%. Increase cable gauge if voltage drop is 2% or more.

5. SELECTING THE MOUNTING POSITION

Decide the mounting position with the customer as follows:

5.1. Indoor unit

- (1) Install the indoor unit level on a strong wall which is not subject to vibration.
- (2) The inlet and outlet ports should not be obstructed : the air should be able to blow all over the room.
- (3) Install the unit a dedicated electrical branch circuit.
- (4) Do not install the unit where it will be exposed to direct sunlight.
- (5) Install the unit where connection to the outdoor unit is easy.
- (6) Install the unit where the drain pipe can be easily installed.
- (7) Take servicing, etc. into consideration and leave the spaces shown in [6.1. Installation dimensions]. Also install the unit where the filter can be removed.

Correct initial installation location is important because it is difficult to move unit after it is installed.

⚠ WARNING

Select installation locations that can properly support the weight of the indoor unit. Install the units securely so that they do not topple or fall.

⚠ CAUTION

- Do not install the unit in the following areas:
- Area with high salt content, such as at the seaside. It will deteriorate metal parts, causing the parts to fail or the unit to leak water.
 - Area filled with mineral oil or containing a large amount of splashed oil or steam, such as a kitchen.
It will deteriorate plastic parts, causing the parts to fail or the unit to leak water.
 - Area that generates substances that adversely affect the equipment, such as sulfuric gas, chlorine gas, acid, or alkali.
It will cause the copper pipes and brazed joints to corrode, which can cause refrigerant leakage.
 - Area that can cause combustible gas to leak, contains suspended carbon fibers or flammable dust, or volatile inflammables such as paint thinner or gasoline.
 - If gas leaks and settles around the unit, it can cause a fire.
 - Area where animals may urinate on the unit or ammonia may be generated.
 - Do not use the unit for special purposes, such as storing food, raising animals, growing plants, or preserving precision devices or art objects.
 - It can degrade the quality of the preserved or stored objects.
 - Do not install where there is the danger of combustible gas leakage.

- Do not install the unit near a source of heat, steam, or flammable gas.
- Install the unit where drainage does not cause any trouble.
- Install the indoor unit, outdoor unit, power supply cable, connection cable, and remote control cable at least 1 m away from a television or radio receivers. The purpose of this is to prevent TV reception interference or radio noise.
- (Even if they are installed more than 1 m apart, you could still receive noise under some signal conditions.)
- If children under 10 years old may approach the unit, take preventive measures so that they cannot reach the unit.
- Install the indoor unit on the wall where the height from the floors more than 1800 mm.

6. INSTALLATION WORK

6.1. Installation dimensions

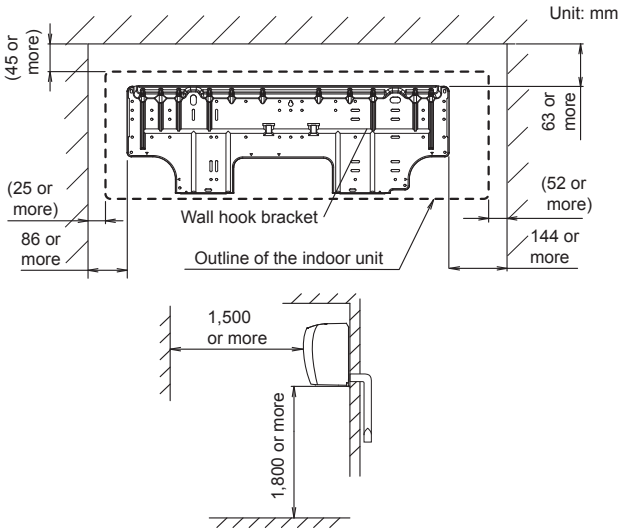

6.2. Indoor unit piping direction

The piping can be connected in the 6 directions indicated in the following. When the piping is connected in direction ②, ③, ④ or ⑤, cut along the piping groove in the side of the front cover with a hacksaw.

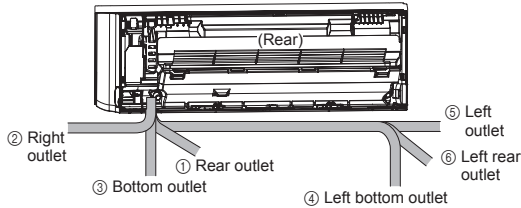

6.3. Cutting the hole in the wall for the connecting piping

- (1) Cut a 65 mm diameter hole in the wall at the position shown in the following.
- (2) Cut the hole so that the outside end is lower (5 to 10 mm) than the inside end.
- (3) Always align the center of the wall hole. If misaligned, water leakage will occur.
- (4) Cut the wall pipe to match the wall thickness, stick it into the wall cap, fasten the cap with vinyl tape, and stick the pipe through the hole.
- (5) For left piping and right piping, cut the hole a little lower so that drain water will flow freely.

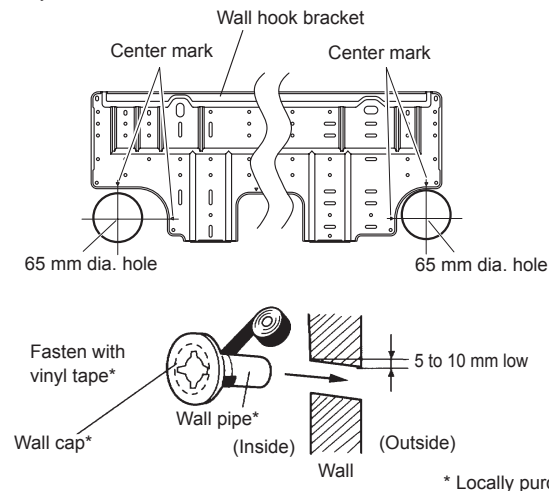

⚠ WARNING

If the wall pipe is not used, the cable interconnecting the indoor unit(s) and outdoor unit may touch metal and cause electric discharge.

6.4. Installing the wall hook bracket

- Remove the wall hook bracket from the indoor unit. (Remove 2 screws).
- (1) Install the wall hook bracket so that it is correctly positioned horizontally and vertically. If the wall hook bracket is tilted, water will drip to the floor.
 - (2) Install the wall hook bracket so that it is strong enough to support the weight of the unit.
 - Fasten the wall hook bracket to the wall with 5 or more screws through the holes near the outer edge of the bracket.
 - Check that there is no rattle at the wall hook bracket.

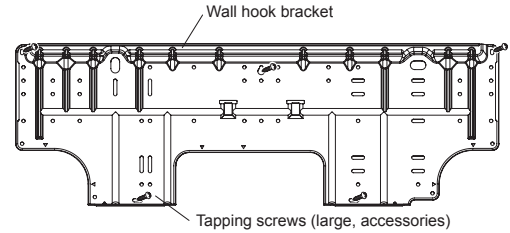

⚠ CAUTION

Install the wall hook bracket both horizontally and vertically aligned. Misaligned installation may cause water leakage.

6.5. Forming the drain hose and pipe

[Rear piping, Right piping, Bottom piping]

- Install the indoor unit piping in the direction of the wall hole and bind the drain hose and pipe together with vinyl tape.
- Install the piping so that the drain hose is at the bottom.
- Wrap the pipes of the indoor unit that are visible from the outside with decorative tape.

[For Left rear piping, Left piping]

Interchange the drain cap and the drain hose.

⚠ CAUTION

- Insert drain hose and drain cap securely. Drain should slope down to avoid water leakage.
- When inserting, be sure not to attach any material besides water. If any other material is attached, it will cause deterioration and water leakage.
- After removing drain hose, be sure not to forget mounting drain cap.
- Be sure to fix the drain hose with tape to the bottom of piping.
- Prevent drain water freezing under low temperature environment. When installing indoor unit's drain hose outdoors, necessary measure for frost protection should be taken to prevent drain water freezing. Under low temperature environment (when outdoor temperature under 0 °C), after cooling operation is executed, water in the drain hose could be frozen. Once drain water is frozen, the drain hose will be blocked and water leakage may result at the indoor unit.

Installation method of Drain cap

Use a hexagonal wrench 4 mm at opposite side to insert the drain cap, till the drain cap contacts the tip of drain cock.

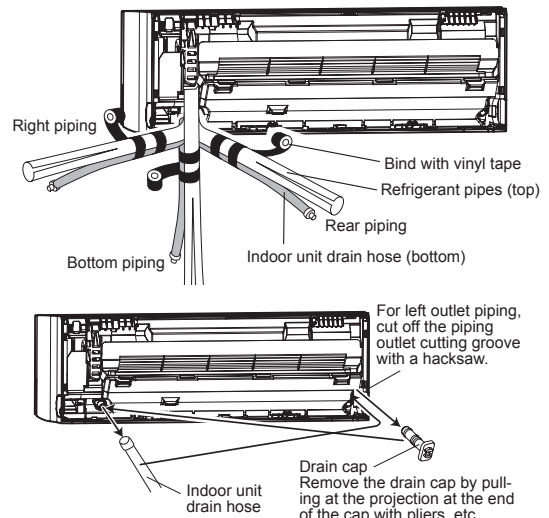
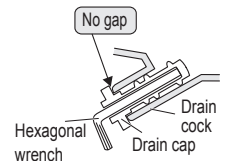

Removal method of drain hose

Remove the screw at the left of drain hose and pull out drain hose.

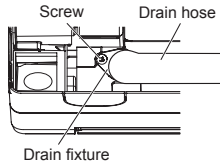

Installation method of drain hose

Vertically insert the drain hose toward the inside, so that the drain fixture (white) can accurately align with the screw hole around the drain cock.
After inserting and before replacing, please reinstall and fix the removed screws.

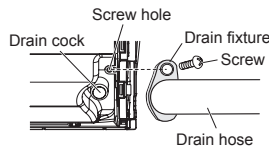

- Please hold around the joint of the drain hose during working.
- As the screw is inside, be sure to use screwdriver treated with magnet.

- For left piping and left rear piping, align the marks on the wall hook bracket and shape the connection pipe.
- Bend the connection piping at a bend radius of 70 mm or more and install no more than 35 mm from the wall.
- After passing the indoor piping and drain hose through the wall hole, hang the indoor unit on the hooks at the top and bottom of the wall hook bracket.

[Installing the indoor unit]

- Hang the indoor unit from the hooks at the top of the wall hook bracket.
- Insert the spacer, etc. between the indoor unit and the wall hook bracket and separate the bottom of the indoor unit from the wall.

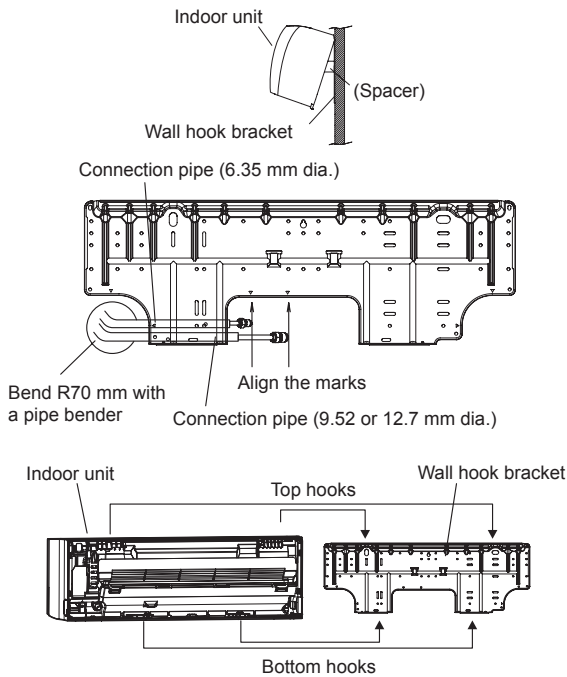

After hooking the indoor unit to the top hook, hook the fittings of the indoor unit to the 2 bottom hooks while lowering the unit and pushing it against the wall.

6.6. Flare connection (Pipe connection)

CAUTION

Tighten the flare nuts with a torque wrench using the specified tightening method. Otherwise, the flare nuts could break after a prolonged period, causing refrigerant to leak and generate hazardous gas if the refrigerant comes into contact with a flame.

6.6.1. Flaring

Use special pipe cutter and flare tool exclusive for R410A.

- (1) Cut the connection pipe to the necessary length with a pipe cutter.
- (2) Hold the pipe downward so that cuttings will not enter the pipe and remove any burrs.
- (3) Insert the flare nut (always use the flare nut attached to the indoor unit(s) and outdoor unit respectively) onto the pipe and perform the flare processing with a flare tool. Use the special R410A flare tool, or the conventional flare tool. Leakage of refrigerant may result if other flare nuts are used.
- (4) Protect the pipes by pinching them or with tape to prevent dust, dirt, or water from entering the pipes.

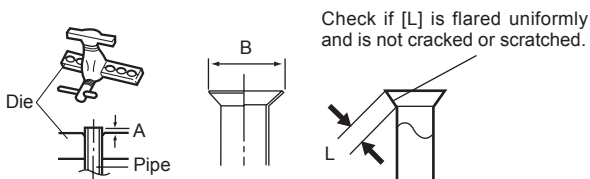

Pipe outside diameter [mm (in.)]	Dimension A [mm]	Dimension B [mm]
	Flare tool for R410A, clutch type	
6.35 (1/4)	0 to 0.5	9.1
9.52 (3/8)		13.2
12.70 (1/2)		16.6
15.88 (5/8)		19.7
19.05 (3/4)		24.0

When using conventional flare tools to flare R410A pipes, the dimension A should be approximately 0.5 mm more than indicated in the table (for flaring with R410A flare tools) to achieve the specified flaring. Use a thickness gauge to measure the dimension A.

Width across flats	Pipe outside diameter [mm (in.)]	Width across flats of Flare nut [mm]
		6.35 (1/4)
9.52 (3/8)		22
12.70 (1/2)		26
15.88 (5/8)		29
19.05 (3/4)		36

6.6.2. Bending pipes

- If pipes are shaped by hand, be careful not to collapse them.
- Do not bend the pipes in an angle more than 90°.
- When pipes are repeatedly bent or stretched, the material will harden, making it difficult to bend or stretch them any more.
- Do not bend or stretch the pipes more than 3 times.

CAUTION

- To prevent breaking of the pipe, avoid sharp bends.
- If the pipe is bent repeatedly at the same place, it will break.

6.6.3. Pipe connection

CAUTION

- Be sure to install the pipe against the port on the indoor unit correctly. If the centering is improper, the flare nut cannot tighten smoothly. If the flare nut is forced to turn, the threads will be damaged.
- Do not remove the flare nut from the indoor unit pipe until immediately before connecting the connection pipe.
- Hold the torque wrench at its grip, keeping it in the right angle with the pipe, in order to tighten the flare nut correctly.
- Tighten the flare nuts with a torque wrench using the specified tightening method. Otherwise, the flare nuts could break after a prolonged period, causing refrigerant to leak and generate hazardous gas if the refrigerant comes into contact with a flame.

CAUTION

- Connect the piping so that the control box cover can easily be removed for servicing when necessary.
- In order to prevent water from leaking into the control box, make sure that the piping is well insulated.

When the flare nut is tightened properly by your hand, hold the body side coupling with a wrench, then tighten with a torque wrench. (See the table below for the flare nut tightening torques.)

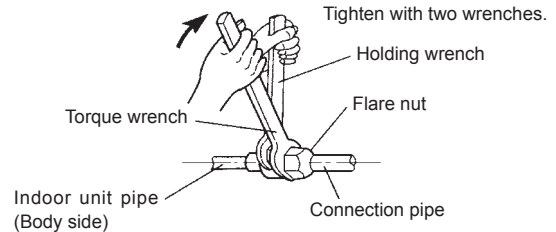

Flare nut [mm (in.)]	Tightening torque [N·m (kgf·cm)]
6.35 (1/4) dia.	16 to 18 (160 to 180)
9.52 (3/8) dia.	32 to 42 (320 to 420)
12.70 (1/2) dia.	49 to 61 (490 to 610)
15.88 (5/8) dia.	63 to 75 (630 to 750)
19.05 (3/4) dia.	90 to 110 (900 to 1,100)

7. ELECTRICAL WIRING

7.1. Wiring system diagram

⚠ WARNING

- Every wire must be connected firmly.
- No wire should be allowed to touch refrigerant tubing, the compressor or any moving part.
- Loose wiring may cause the terminal to overheat or result in unit malfunction. A fire hazard may also exist. Therefore, be sure all wiring is tightly connected.
- Connect wires to the matching numbers of terminals.

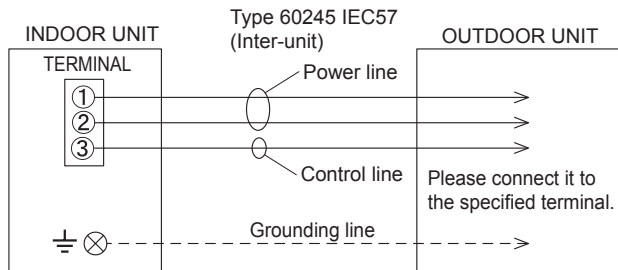

7.2. Indoor unit wiring

1. Remove the wire cover. (Remove 1 screw.)
2. Remove the cable clamp.
3. Ring terminals connect to the connection cable.
4. Connect the ring terminals fully into the terminal block.
5. Fasten the connection cable with a cable clamp.

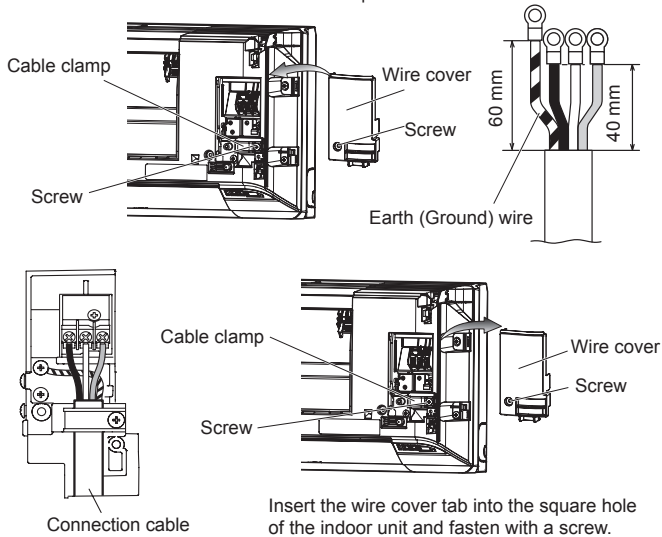

7.3. How to connect wiring to the terminals

Caution when wiring cable

- When stripping off the insulation of a lead wire, always use a special tool such as a wire stripper. If there is no special tool available, carefully strip the insulation with a knife etc.
- (1) Use ring terminals with insulating sleeves as shown in the figure to connect to the terminal block.
 - (2) Securely clamp the ring terminals to the wires by using an appropriate tool so that the wires do not come loose.

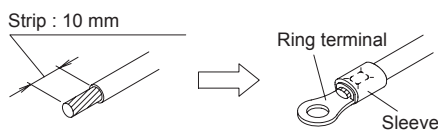

- (3) Use the specified wires, connect them securely, and fasten them so that there is no stress placed on the terminals.
- (4) Use an appropriate screwdriver to tighten the terminal screws. Do not use a screwdriver that is too small, otherwise, the screw heads may be damaged and prevent the screws from being properly tightened.
- (5) Do not tighten the terminal screws too much, otherwise, the screws may break.

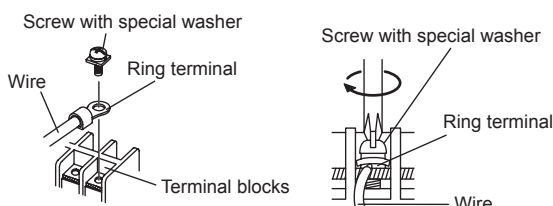

- (6) See the following table for the terminal screw tightening torques.

Tightening torque [N·m (kgf·cm)]

M4 screw	1.2 to 1.8 (12 to 18)
----------	-----------------------

⚠ CAUTION

- Match the terminal block numbers and connection cable colors with those of the outdoor unit.
- Erroneous wiring may cause burning of the electric parts.
- Connect the connection cables firmly to the terminal block. Imperfect installation may cause a fire.
- Always fasten the outside covering of the connection cable with the cable clamp. (If the insulator is chafed, electric discharge may occur.)
- Always connect the ground wire.
- Do not use the earth screw of the indoor unit for the connection other than a specified outdoor unit.

8. FINISHING

- (1) Insulate between pipes.
 - Insulate suction and discharge pipes separately.
 - For rear, right, and bottom piping, overlap the connection pipe heat insulation and indoor unit pipe heat insulation and bind them with vinyl tape so that there is no gap.
 - For left and left rear piping, butt the connection pipe heat insulation and indoor unit pipe heat insulation together and bind them with and vinyl tape so that there is no gap.
 - For left and left rear piping, wrap the area which accommodates the rear piping housing section with cloth tape.
 - For left and left rear piping, bind the connection cable to the top of the pipe with vinyl tape.
 - For left and left rear piping, bundle the piping and drain hose together by wrapping them with cloth tape over the range within which they fit into the rear piping housing section.
- (2) Temporarily fasten the connection cable along the connection pipe with vinyl tape. (Wrap to about 1/3 the width of the tape from the bottom of the pipe so that water does not enter.)
- (3) Fasten the connection pipe to the outside wall with a saddle, etc.
- (4) Fill the gap between the outside wall pipe hole and the pipe with sealer so that rain water and wind cannot blow in.
- (5) Fasten the drain hose to the outside wall, etc.

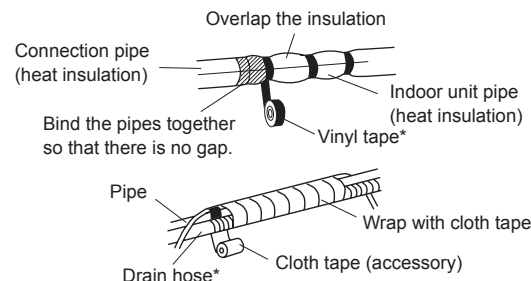
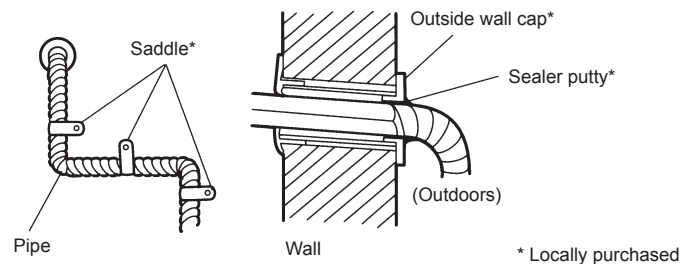

Seal A is used when the diameter of gas pipe is $\varnothing 12.70$ or more.

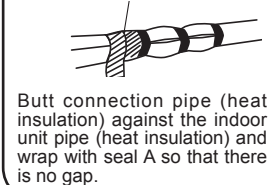

Left piping

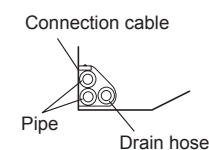

For connection from the left rear

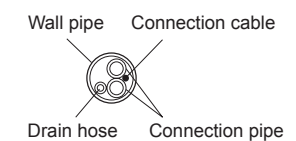

Check the following:

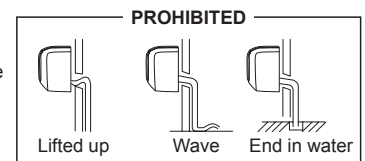

9. FRONT PANEL REMOVAL AND INSTALLATION

Intake grille removal

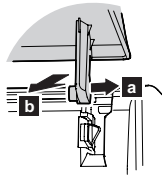

Open the intake grille. While gently pressing the left and right mounting shafts of the intake grille outward "a", remove the intake grille in direction of the arrow "b".

Intake grille installation

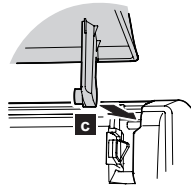

While holding the grille horizontal, set the left and right mounting shafts into the pillow blocks at the top of the panel "c". To latch each shaft properly, insert the shaft until it snaps. Press 4 places on the intake grille to close it completely.

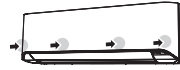

9.1. Front panel removal

- Remove intake grille (Refer to the "Intake grille removal".)
- Remove wire cover.
- Remove 6 screws.

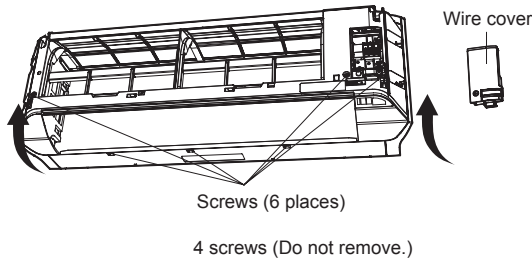

Screws (6 places)

4 screws (Do not remove.)

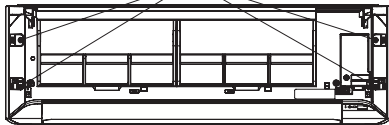

- Pull the front panel to the front, then raise it to remove.

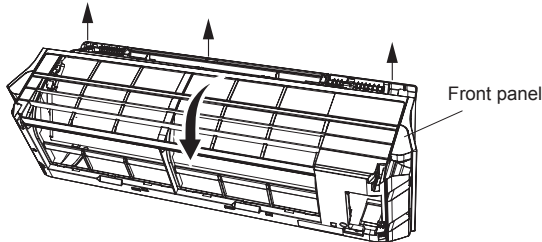

9.2. Front panel installation

- First, fit the lower part of the front panel, and insert top and bottom hooks. (3 top sides, 2 center)

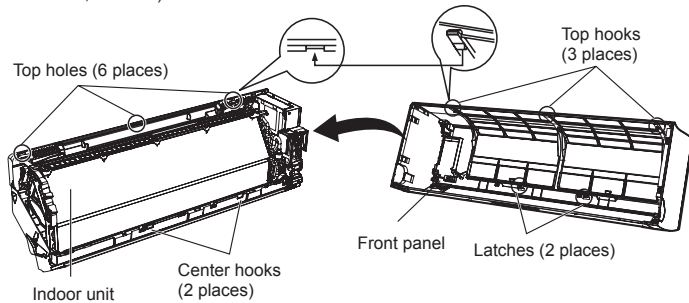

- Attach the 6 screws.
- Attach the wire cover.
- Attach the intake grille.

CAUTION

Install the Front panel and Intake grille securely. If installation is imperfect, the Front panel or Intake grille may fall off and cause injury.

10. REMOTE CONTROLLER INSTALLATION

CAUTION

- Check that the indoor unit correctly receives the signal from the remote controller, then install the remote controller holder.
- Select the remote controller holder selection site by paying careful attention to the following:
 - Avoid places in direct sunlight.
 - Select a place that will not be affected by the heat from a stove, etc.

10.1. Remote controller holder installation

- Install the remote controller a maximum distance of 7 m from the remote controller receiver. However, when installing the remote controller, check that it operates correctly.
- Install the remote controller holder to a wall, pillar, etc. with the tapping screw.

Remote controller holder fixing

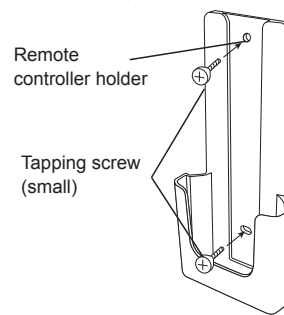

Remote controller mounting

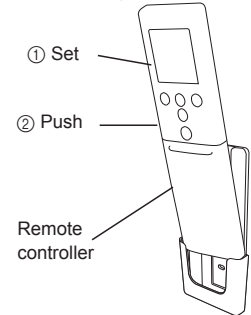

10.2. Remote controller custom setting

Use the following steps to select the custom code of the remote controller. (Note that the air conditioner cannot receive a signal if the air conditioner has not been set for the matching custom code.)

- Press the "START/STOP (ON/OFF)" button until only the clock is displayed on the remote controller display.
- Press the "MODE" button for at least 5 seconds to display the current custom code (initially set to A).
- Press the "TEMP." (▲/▼) buttons to change the custom code between $\rightarrow A \leftrightarrow B \leftrightarrow C \leftrightarrow D \leftarrow$. Match the code on the display to the air conditioner custom code.
- Press the "MODE" button again to return to the clock display. The custom code will be changed.

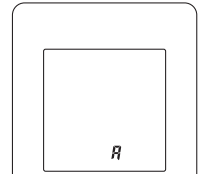

- If no buttons are pressed within 30 seconds after the custom code is displayed, the system returns to the original clock display. In this case, start again from step 1.
- The air conditioner custom code is set to A prior to shipment.

11. OPTIONAL KIT INSTALLATION

This air conditioner can be connected with the following optional kits.

- Wired remote controller
- Simple remote controller
- External connect kit

CAUTION

- Before installing, be sure to disconnect all power supply.
- Don't touch the heat exchanger.
- During installing or removing operation, be sure not to have wire caught by parts or draw it hard. Or it may result troubles to the air-conditioner.
- Avoid place in direct sunlight.
- Select place that will not be affected by the heat from a stove, etc.
- Before setting up the optional kit, please confirm whether air-conditioner can receive the signal.
- Do not connect the wired remote controller to the terminal for power supply.
- When connecting the wired remote controller with the indoor unit, use the connecting cable (supplied with wired remote controller or simple remote controller).
- Recommended cable length of wired remote controller is 10 m. Make sure to insulate the connecting part when extending the cable.

- When you use wired remote controller, some functions may not be used.
- Do not connect power supply with the terminal.

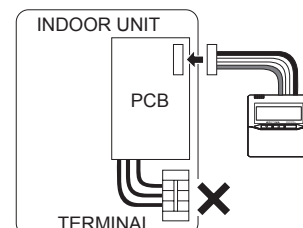

11.1. Remote controller cable modification

- Use a tool to cut off the terminal on the end of the remote controller cable, and remove the insulation from the cut end of the cable.
- Connect the remote controller cable and connecting cable.
(supplied with wired remote controller)

Important: Be sure to solder wires to connect. Be sure to insulate the connection between the wires.

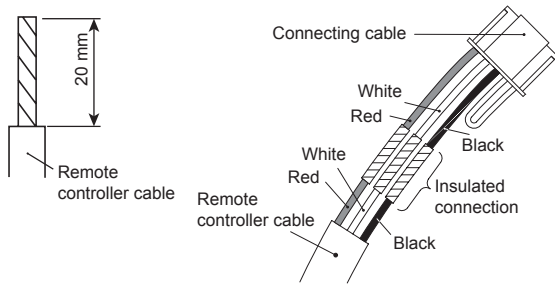

11.2. Installing wired remote controller terminal / external connect kit terminal (sold separately)

- Remove the screw on the control box as shown on the top right of the figure below.
- Release both bottom clasps at the sides in the direction of the arrow as circled in the bottom left of the figure below. Pull and remove the cover.

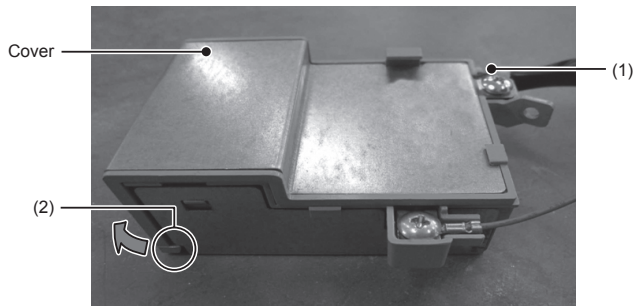

- Connect the wired remote controller terminal / external connect kit terminal (sold separately) to the specified terminal on the board as shown below. Please connect to the connector with necessary function according to the actual usage.
- After connecting each terminal, thread the cables through the notch as circled on the bottom right of the figure below.

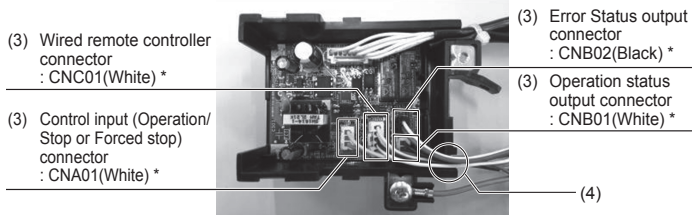

* : Symbol indicating the location printed on the board

- Install the control box cover as shown below.
(Align the cover with the upper and lower right corners as indicated by the triangular symbols on the figure.
Insert the clasps on the cover into both sides at the bottom of the two dotted circles.)
 - When installing the control box cover, make sure that the cables are not caught as shown in the detail view.
- Install one screw.
- Screw the earth wire of wired remote controller as shown in the figure. (AUSTRALIA model only).

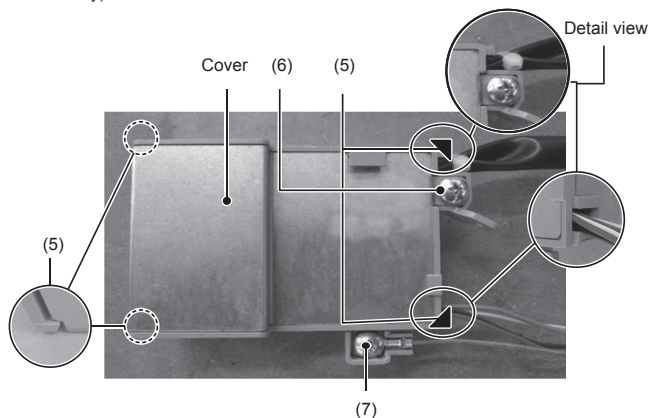

11.3. Installing communication box

11.3.1. Removing intake grille (Refer to "9.1. Front panel removal")

11.3.2. Removing control box

- Remove the screws (x4). (Use the same screws when installing.)
- Pull the control box cover towards you and remove.

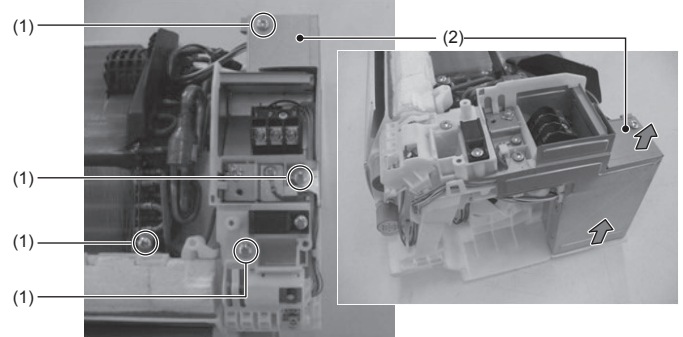

- Remove the connectors (x4).
 - Remove and pull off the lock at the side of the connector insertion part.

CAUTION

- Be careful not to damage the parts on the board. Otherwise, it will cause malfunction.

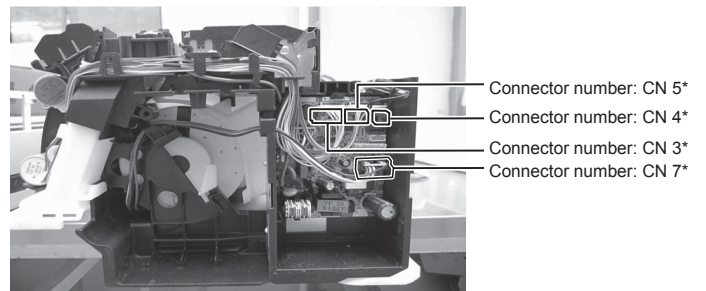

* : Symbol indicating the location printed on the board

- Remove the wires from the three fixtures. (See the figure below)
 - Leave the thick green wire in fixture C and remove the rest of the wires.

CAUTION

- Do not pull the wires forcibly. You may damage them.

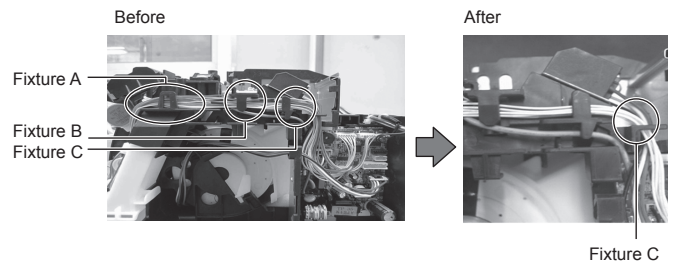

- While pulling the control box towards you, remove in the right direction.
 - Do not remove the thermistor.
 - Do not damage the terminals on the removed wires.

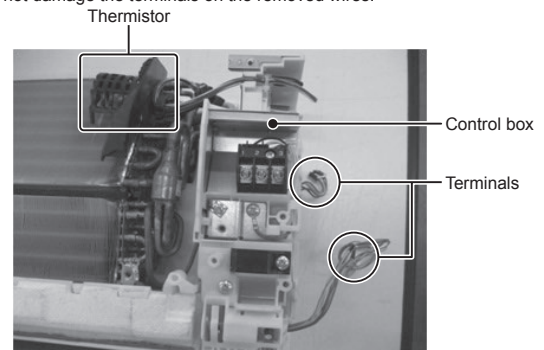

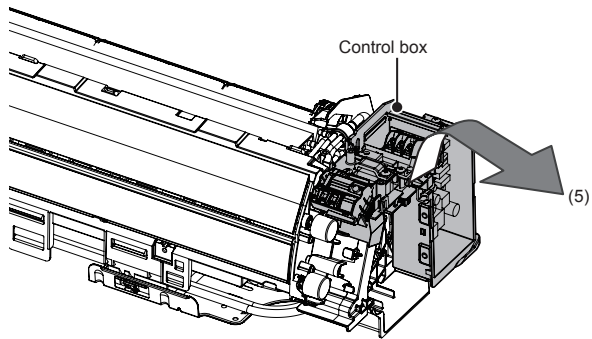

11.3.3. Installing communication box

- (1) Install the communication box on the main unit and secure it with the provided screw at the location shown below.

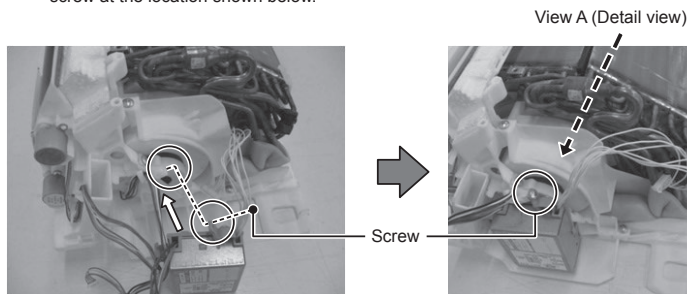

View A (Detail view)

Motor cover

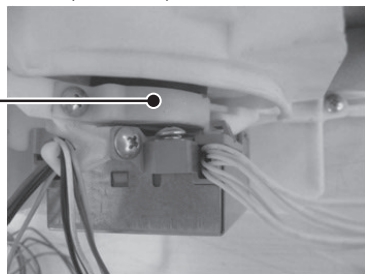

- (2) Use the hole on the motor cover and secure the wire from the communication box with the provided cable tie (accessory for option). (See the figure below)

Cut away the tip of the cable tie.

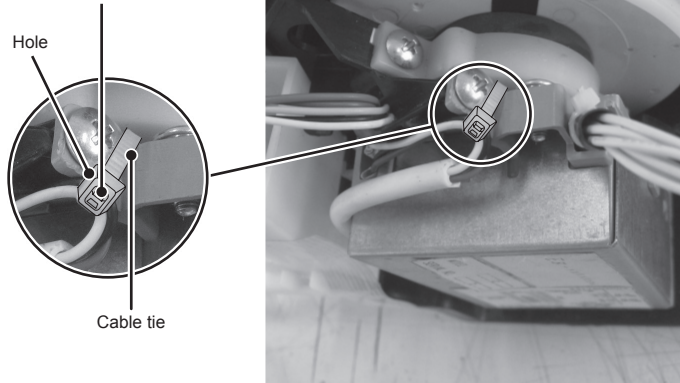

11.3.4. Installing control box

- (1) Set the control box toward the bottom so that it touches the motor cover from the right.

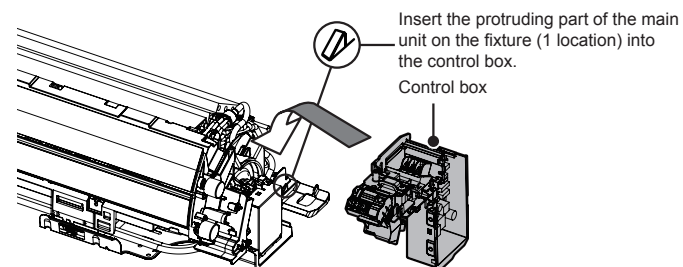

- The installation method of the control box is different for each destination country. (When installing, reuse the screw that was removed in 11.3.2. **Removing control box.**)

- (2) Secure the control box with a screw. (Use a long screw.)

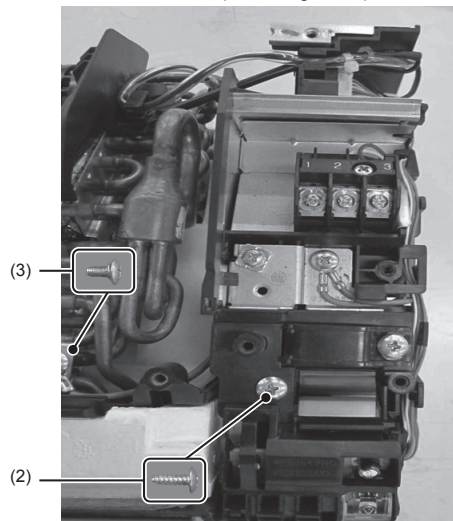

- (3) Fasten the earth wires of the heat exchanger together as shown in the left figure above. (Use a short screw here.)
- (4) Hitch the wires onto the fixtures as shown in the oval circles below. Then connect the connectors in the squares to the terminals respectively. (Each terminal should form a pair with a connector.)

CAUTION

- Ensure that the connector is properly inserted. Otherwise, it may result in erroneous operation.
- Be careful not to damage the parts on the board. Otherwise, it will cause malfunction.

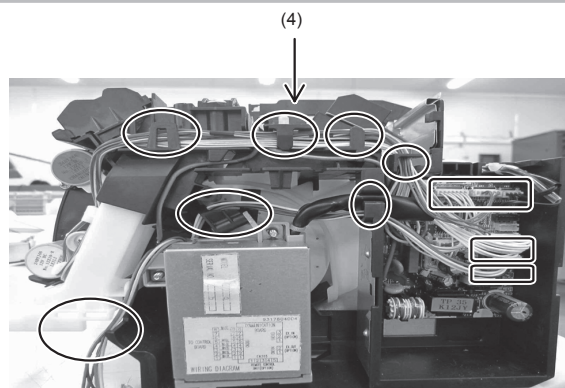

- (5) Fasten the earth wire (green) in the communication box together with the earth wire (green) on the board of the control box as shown in the following figure.

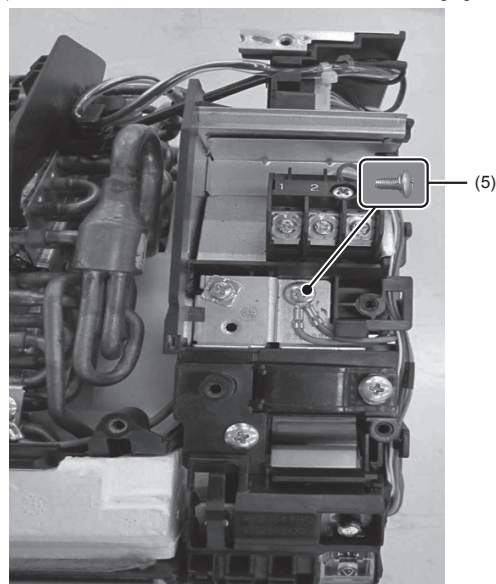

- (6) Install the cover of the control box onto the inner side of the rib as follows.

CAUTION

- Do not cut or tuck the wires with the electrical component box cover. An electric shock may occur if the wires are damaged.

- (7) Tighten with screws to prevent the cover of the control box from falling off. (When installing, reuse the screws that was removed in 13.3.2. Removing control box.)

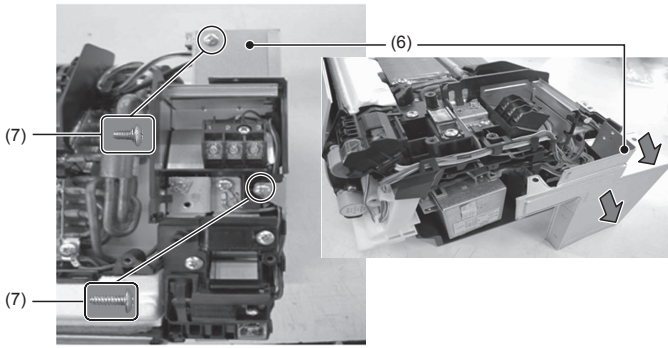

- (8) Paste protect seals (2 locations) to prevent the wires from sticking out.

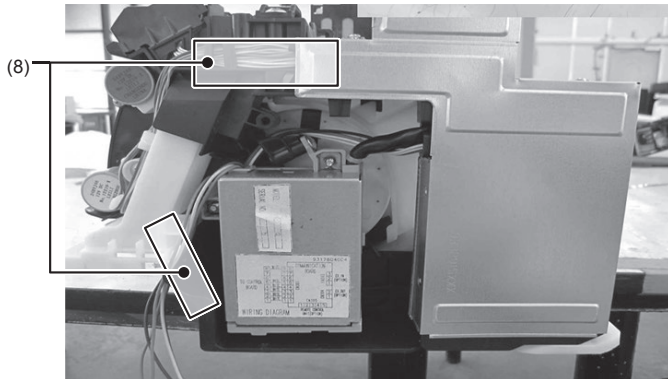

11.3.5. Installing front panel (Refer to "9.2. Front panel installation")

12.FUNCTION SETTING

Perform the "FUNCTION SETTING" according to the installation conditions using the remote controller.

CAUTION

- Confirm whether the wiring work for Outdoor unit has been finished.
- Confirm that the cover for the electrical enclosure on the outdoor unit is in place.

- This procedure changes the function settings used to control the indoor unit according to the installation conditions. Incorrect settings can cause the indoor unit to malfunction.
- After the power is turned on, perform the "FUNCTION SETTING" according to the installation conditions using the remote controller.
- The settings may be selected between the following two: Function Number or Setting Value.
- Settings will not be changed if invalid numbers or setting values are selected.
- Refer to the installation manual enclosed with the remote controller when the wired remote controller (option) is used.

Entering the Function Setting Mode

While pressing the POWERFUL button and SET TEMP. (\wedge / \vee) simultaneously, press the RESET button to enter the function setting mode.

STEP 1

Selecting the Remote Controller Custom Code

Use the following steps to select the custom code of the Remote Controller. (Note that the air conditioner cannot receive a signal if the air conditioner has not been set for the matching custom code.)

The custom codes that are set through this process are applicable only to the signals in the FUNCTION SETTING. For details on how to set the custom codes through the normal process, refer to "Remote controller custom code".

- (1) Press SET TEMP. (\wedge / \vee) button to change the custom code between $\square \rightarrow A \leftrightarrow B \leftrightarrow C \leftrightarrow D \leftarrow \square$. Match the code on the display to the air conditioner custom code. (initially set to A) (If the custom code does not need to be selected, press the 10°C HEAT button and proceed to STEP 2.)
- (2) Press the MODE button and check that the indoor unit can receive signals at the displayed custom code.
- (3) Press the 10°C HEAT button to accept the custom code, and proceed to STEP 2.

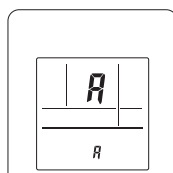

STEP 2

Selecting the Function Number and Setting Value

- (1) Press the SET TEMP. (\wedge / \vee) buttons to select the function number. (Press the 10°C HEAT button to switch between the left and right digits.)
- (2) Press the POWERFUL button to proceed to setting value. (Press the POWERFUL button again to return to the function number selection.)
- (3) Press the SET TEMP. (\wedge / \vee) buttons to select the setting value. (Press the 10°C HEAT button to switch between the left and right digits.)
- (4) Press the MODE button, and START/STOP button, in the order listed to confirm the settings.
- (5) Press the RESET button to cancel the function setting mode.
- (6) After completing the Function Setting, be sure to disconnect the power supply and then reconnect it.

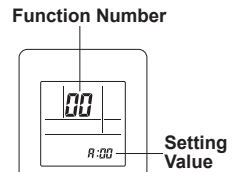

CAUTION

After disconnecting the power supply, wait 30 seconds or more before reconnecting it. The Function Setting will not become active unless the power supply is disconnected and then reconnected.

Filter sign

Select appropriate intervals for displaying the filter sign on the indoor unit according to the estimated amount of dust in the air of the room.

If the indication is not required, select "No indication" (03).

(♦... Factory setting)

Function Number	Setting Value	Setting Description
11	00	Standard (400 hours)
	01	Long interval (1,000 hours)
	02	Short interval (200 hours)
	03	No indication ♦

Room temperature sensor control for cooling

Depending on the installed environment, correction of the room temperature sensor may be required.

Select the appropriate control setting according to the installed environment.

(♦... Factory setting)

Function Number	Setting Value	Setting Description
30	00	Standard ♦
	01	Slightly lower control
	02	Lower control
	03	Higher control

Room temperature sensor control for heating

Depending on the installed environment, correction of the room temperature sensor may be required.

Select the appropriate control setting according to the installed environment.

(♦... Factory setting)

Function Number	Setting Value	Setting Description
31	00	Standard ♦
	01	Lower control
	02	Slightly higher control
	03	Higher control

Auto restart

Enable or disable automatic restart after a power interruption.

(♦... Factory setting)

Function Number	Setting Value	Setting Description
40	00	Enable ♦
	01	Disable

* Auto restart is an emergency function such as for power outage etc. Do not attempt to use this function in normal operation. Be sure to operate the unit by remote controller or external device.

The air conditioner custom code is set to A prior to shipment.

Room temperature sensor switching

(Only for wired remote controller)

When using the Wired remote controller temperature sensor, change the setting to "Both" (01).

(◆... Factory setting)

Function Number	Setting Value	Setting Description
42	00	Indoor unit
	01	Both

00: Sensor on the indoor unit is active.

01: Sensors on both indoor unit and wired remote controller are active.

* Remote controller sensor must be turned on by using the remote controller.

Remote controller custom code

(Only for wireless remote controller)

The indoor unit custom code can be changed. Select the appropriate custom code.

(◆... Factory setting)

Function Number	Setting Value	Setting Description
44	00	A
	01	B
	02	C
	03	D

External input control

"Operation/Stop" mode or "Forced stop" mode can be selected.

(◆... Factory setting)

Function Number	Setting Value	Setting Description
46	00	Operation/Stop mode
	01	(Setting prohibited)
	02	Forced stop mode

Room temperature sensor switching (Aux.)

To use the temperature sensor on the wired remote controller only, change the setting to "Wired remote controller" (01). This function will only work if the function setting 42 is set at "Both" (01)

(◆... Factory setting)

Function Number	Setting Value	Setting Description
48	00	Both
	01	Wired remote controller

Indoor unit fan control for energy saving for cooling

Enables or disables the power-saving function by controlling the indoor unit fan rotation when the outdoor unit is stopped during cooling operation.

(◆... Factory setting)

Function Number	Setting Value	Setting description
49	00	Disable
	01	Enable

00: When the outdoor unit is stopped, the indoor unit fan operates continuously following the setting on the remote controller.

01: When the outdoor unit is stopped, the indoor unit fan operates intermittently at a very low speed.

Setting record

Record any changes to the settings in the following table.

Setting Description	Setting Value
Filter sign	
Room temperature sensor control for cooling	
Room temperature sensor control for heating	
Auto restart	
Room temperature sensor switching	
Remote controller custom code	
External input control	
Room temperature sensor switching (Aux.)	
Indoor unit fan control for energy saving for cooling	

After completing the Function Setting, be sure to disconnect the power supply and then reconnect it.

13. TEST RUN

Check items

- Is operation of each button on the remote controller normal?
- Does each lamp light normally?
- Do airflow direction louvers operate normally?
- Is the drain normal?
- Do not have an abnormal noise and vibration during operation?
 - Do not operate the air conditioner in test run for a long time.

[Operation method]

- For the operation method, refer to the operating manual.
- The outdoor unit, may not operate, depending on the room temperature. In this case, keep on pressing the MANUAL AUTO button of the indoor unit for more than 10 seconds. The operation indicator lamp and timer indicator lamp will begin to flash simultaneously during cooling test run. Then, heating test run will begin in about three minutes when HEAT is selected by the remote control operation. (Please follow the operating manual for remote control operation.)

- To end test operation, press the remote controller START/STOP button. (When the air conditioner is running by pressing the test run button, the OPERATION Lamp and TIMER Lamp will simultaneously flash slowly.)

[Using the wired remote controller] (Option)

For the operation method, refer to the operating manual.

- Stop the air conditioner operation.
- Press the master control button and the fan control button simultaneously for 2 seconds or more to start the test run.

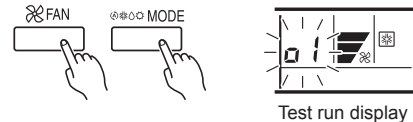

- Press the start/stop button to stop the test run.

14. CUSTOMER GUIDANCE

Explain the following to the customer in accordance with the operating manual:

- Starting and stopping method, operation switching, temperature adjustment, timer, air-flow switching, and other remote controller operations.
- Air filter removal and cleaning, and how to use the air louvers.
- Give the operating manual to the customer.

15.ERROR CODES

If you use a wireless remote controller, the lamp on the photo detector unit will output error codes by way of blinking patterns. If you use a wired remote controller, error codes will appear on the remote control display. See the lamp blinking patterns and error codes in the table. An error display is displayed only during operation.

Error display			Error code	Description
OPERATION lamp (green)	TIMER lamp (orange)	ECONOMY lamp (green)		
●(1)	●(1)	◇	11	Serial communication error
●(1)	●(2)	◇	12	• Wired remote controller communication error • Server room control communication error
●(1)	●(5)	◇	15	Check run unfinished
●(1)	●(6)	◇	16	Peripheral unit transmission PCB connection error
●(1)	●(8)	◇	18	External communication error
●(2)	●(1)	◇	21	Unit number or Refrigerant circuit address setting error [Simultaneous Multi]
●(2)	●(2)	◇	22	Indoor unit capacity error
●(2)	●(3)	◇	23	Combination error
●(2)	●(4)	◇	24	• Connection unit number error (indoor secondary unit) [Simultaneous Multi] • Connection unit number error (indoor unit or branch box) [Flexible Multi]
●(2)	●(6)	◇	26	Address setting error in wired remote controller system
●(2)	●(7)	◇	27	Primary unit, secondary unit set-up error [Simultaneous Multi]
●(3)	●(2)	◇	32	Indoor unit PCB model information error
●(3)	●(5)	◇	35	Manual auto switch error
●(4)	●(1)	◇	41	Room temp. sensor error
●(4)	●(2)	◇	42	Indoor unit Heat Ex. Middle temp. sensor error
●(5)	●(1)	◇	51	Indoor unit fan motor 1 error (Main fan)
●(5)	●(3)	◇	53	Drain pump error
●(5)	●(4)	◇	54	Electric air cleaner reverse VDD error
●(5)	●(5)	◇	55	Filter set error
●(5)	●(7)	◇	57	Damper error
●(5)	●(8)	◇	58	Intake grille error
●(5)	●(9)	◇	59	Indoor unit fan motor 2 error (Left side fan)
●(5)	●(10)	◇	5A	Indoor unit fan motor 3 error (Right side fan)
●(5)	●(15)	◇	5U	Indoor unit error
●(6)	●(2)	◇	62	Outdoor unit main PCB model information error or communication error
●(6)	●(3)	◇	63	Inverter error
●(6)	●(4)	◇	64	Active filter error, PFC circuit error
●(6)	●(5)	◇	65	Trip terminal L error
●(6)	●(8)	◇	68	Outdoor unit rush current limiting resistor temp. rise error

Error display			Error code	Description
OPERATION lamp (green)	TIMER lamp (orange)	ECONOMY lamp (green)		
●(6)	●(10)	◇	6A	Display PCB microcomputers communication error
●(7)	●(1)	◇	71	Discharge temp. sensor error
●(7)	●(2)	◇	72	Compressor temp. sensor error
●(7)	●(3)	◇	73	Outdoor unit Heat Ex. liquid temp. sensor error
●(7)	●(4)	◇	74	Outdoor temp. sensor error
●(7)	●(5)	◇	75	Suction Gas temp. sensor error
●(7)	●(6)	◇	76	• 2-way valve temp. sensor error • 3-way valve temp. sensor error
●(7)	●(7)	◇	77	Heat sink temp. sensor error
●(8)	●(2)	◇	82	• Sub-cool Heat Ex. gas inlet temp. sensor error • Sub-cool Heat Ex. gas outlet temp. sensor error
●(8)	●(3)	◇	83	Liquid pipe temp. sensor error
●(8)	●(4)	◇	84	Current sensor error
●(8)	●(6)	◇	86	• Discharge pressure sensor error • Suction pressure sensor error • High pressure switch error
●(9)	●(4)	◇	94	Trip detection
●(9)	●(5)	◇	95	Compressor rotor position detection error
●(9)	●(7)	◇	97	Outdoor unit fan motor error
●(9)	●(9)	◇	99	4-way valve error
●(10)	●(1)	◇	A1	Discharge temp. error
●(10)	●(3)	◇	A3	Compressor temp. error
●(10)	●(4)	◇	A4	High pressure error
●(10)	●(5)	◇	A5	Low pressure error
●(13)	●(2)	◇	J2	Branch boxes error [Flexible Multi]

Display mode ● : 0.5s ON / 0.5s OFF
◇ : 0.1s ON / 0.1s OFF
() : Number of flashing

[Troubleshooting with the indoor unit display]

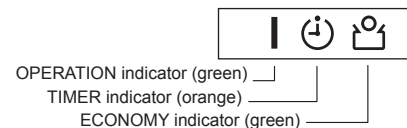
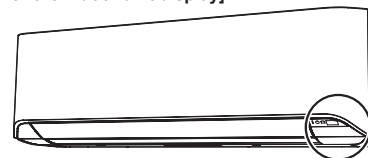

[Troubleshooting with the Wired Remote Controller Display (Option)]

If an error occurs, the following display will be shown. ("Er" will appear in the set room temperature display.)



