

AIR CONDITIONER INDOOR UNIT Wall Mounted Type

INSTALLATION MANUAL

For authorized service personnel only.

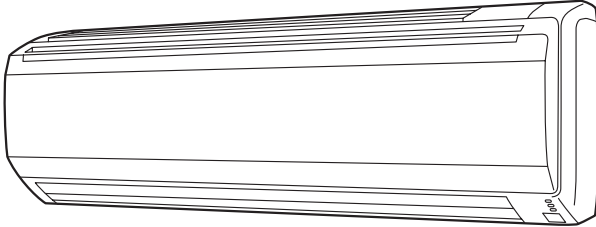

INSTALLATION MANUAL

For authorized service personnel only.

English

INSTALLATIONSANLEITUNG

Nur für autorisiertes Fachpersonal.

Deutsch

MANUEL D'INSTALLATION

Pour le personnel agréé uniquement.

Français

MANUAL DE INSTALACIÓN

Sólo para personal de mantenimiento autorizado.

Español

MANUALE DI INSTALLAZIONE

Esclusivamente destinato al personale autorizzato.

Italiano

ΕΓΧΕΙΡΙΔΙΟ ΕΓΚΑΤΑΣΤΑΣΗΣ

Μόνο για εξουσιοδοτημένο προσωπικό του σέρβις.

Ελληνικά

MANUAL DE INSTALAÇÃO

Apenas para técnicos de assistência autorizados.

Português

РУКОВОДСТВО ПО УСТАНОВКЕ

Только для авторизованного обслуживающего персонала.

Русский

MONTAJ KILAVUZU

Sadece yetkili servis personeli içindir.

Türkçe



PART NO. 9318739084-02

INSTALLATION MANUAL

PART NO. 9318739084-02

INDOOR UNIT (Wall Mounted Type)

[Original instructions]

Contents

1. SAFETY PRECAUTIONS.....	1
2. ABOUT THE UNIT.....	1
2.1. Precautions for using R410A refrigerant.....	1
2.2. Special tools for R410A.....	1
2.3. For authorized service personnel only.....	2
2.4. Accessories.....	2
2.5. Optional parts.....	2
3. GENERAL.....	2
3.1. Type of copper pipe and insulation material.....	2
3.2. Additional materials required for installation.....	2
4. ELECTRICAL REQUIREMENT.....	2
5. SELECTING THE MOUNTING POSITION.....	3
6. INSTALLATION WORK.....	3
6.1. Installation dimensions.....	3
6.2. Indoor unit piping direction.....	3
6.3. Cutting the hole in the wall for the connecting piping.....	3
6.4. Installing the wall hook bracket.....	3
6.5. Forming the drain hose and pipe.....	4
6.6. Flare connection (Pipe connection).....	4
7. ELECTRICAL WIRING.....	5
7.1. Wiring system diagram.....	5
7.2. Indoor unit wiring.....	5
7.3. How to connect wiring to the terminals.....	5
8. FINISHING.....	6
9. FRONT PANEL REMOVAL AND INSTALLATION.....	6
9.1. Intake grille removal.....	6
9.2. Intake grille installation.....	6
9.3. Front panel removal.....	6
9.4. Front panel installation.....	6
10. TEST RUN.....	7
11. REMOTE CONTROLLER INSTALLATION.....	7
11.1. Remote controller holder installation.....	7
12. OPTIONAL KIT INSTALLATION (OPTION).....	7
12.1. Before install optional remote controller.....	7
12.2. Remote controller cable modification.....	7
12.3. External input / output Wire modification.....	7
12.4. Front panel, control box cover and display case removal.....	8
12.5. Connecting cable to control board connector.....	8
12.6. Front panel, control box cover and display case installation.....	8
13. FUNCTION SETTING.....	8
14. CUSTOMER GUIDANCE.....	9
15. ERROR CODES.....	10

1. SAFETY PRECAUTIONS

- Be sure to read this Manual thoroughly before installation.
- The warnings and precautions indicated in this Manual contain important information pertaining to your safety. Be sure to observe them.
- Hand this Manual, together with the Operating Manual, to the customer. Request the customer to keep them on hand for future use, such as for relocating or repairing the unit.

 WARNING	This mark indicates procedures which, if improperly performed, might lead to the death or serious injury of the user.
Request your dealer or a professional installer to install the indoor unit in accordance with this Installation Manual. An improperly installed unit can cause serious accidents such as water leakage, electric shock, or fire. If the indoor unit is installed in disregard of the instructions in the Installation Manual, it will void the manufacturer's warranty.	
Do not turn ON the power until all work has been completed. Turning ON the power before the work is completed can cause serious accidents such as electric shock or fire.	
If refrigerant leaks while work is being carried out, ventilate the area. If the refrigerant comes in contact with a flame, it produces a toxic gas.	
Installation work must be performed in accordance with national wiring standards by authorized personnel only.	
This appliance is not intended for use by persons (including children) with reduced physical, sensory or mental capabilities, or lack of experience and knowledge, unless they have been given supervision or instruction concerning use of the appliance by a person responsible for their safety. Children should be supervised to ensure that they do not play with the appliance.	

CAUTION

This mark indicates procedures which, if improperly performed, might possibly result in personal harm to the user, or damage to property.

Read carefully all security information before use or install the air conditioner.
Do not attempt to install the air conditioner or a part of the air conditioner by yourself.
This unit must be installed by qualified personnel with a capacity certificate for handling refrigerant fluids. Refer to regulation and laws in use on installation place.
The installation must be carried out in compliance with regulations in force in the place of installation and the installation instructions of the manufacturer.
This unit is part of a set constituting an air conditioner. It must not be installed alone or with non-authorized by the manufacturer.
Always use a separate power supply line protected by a circuit breaker operating on all wires with a distance between contact of 3mm for this unit.
The unit must be correctly earthed (grounded) and the supply line must be equipped with a differential breaker in order to protect the persons.
The units are not explosion proof and therefore should not be installed in explosive atmosphere.
Never touch electrical components immediately after the power supply has been turned off. Electric shock may occur. After turning off the power, always wait 5 minutes before touching electrical components.
This unit contains no user-serviceable parts. Always consult authorized service personnel to repairs.
When moving, consult authorized service personnel for disconnection and installation of the unit.

2. ABOUT THE UNIT

2.1. Precautions for using R410A refrigerant

The basic installation work procedures are the same as conventional refrigerant (R22) models. However, pay careful attention to the following points:
Since the working pressure is 1.6 times higher than that of conventional refrigerant (R22) models, some of the piping and installation and service tools are special. (See the table below.)
Especially, when replacing a conventional refrigerant (R22) model with a new refrigerant R410A model, always replace the conventional piping and flare nuts with the R410A piping and flare nuts.
Models that use refrigerant R410A have a different charging port thread diameter to prevent erroneous charging with conventional refrigerant (R22) and for safety. Therefore, check beforehand. [The charging port thread diameter for R410A is 1/2-20 UNF.]
Be more careful that foreign matter (oil, water, etc.) does not enter the piping than with refrigerant (R22) models. Also, when storing the piping, securely seal the opening by pinching, taping, etc.
When charging the refrigerant, take into account the slight change in the composition of the gas and liquid phases. And always charge from the liquid phase where refrigerant composition is stable.

2.2. Special tools for R410A

Tool name	Contents of change
Gauge manifold	Pressure is high and cannot be measured with a conventional (R22) gauge. To prevent erroneous mixing of other refrigerants, the diameter of each port has been changed. It is recommended the gauge with seals-0.1 to 5.3 MPa (-1 to 53 bar) for high pressure. -0.1 to 3.8 MPa (-1 to 38 bar) for low pressure.
Charge hose	To increase pressure resistance, the hose material and base size were changed.
Vacuum pump	A conventional vacuum pump can be used by installing a vacuum pump adapter.
Gas leakage detector	Special gas leakage detector for HFC refrigerant R410A.

Copper pipes

It is necessary to use seamless copper pipes and it is desirable that the amount of residual oil is less than 40 mg/10 m. Do not use copper pipes having a collapsed, deformed or discolored portion (especially on the interior surface). Otherwise, the expansion valve or capillary tube may become blocked with contaminants. As an air conditioner using R410A incurs pressure higher than when using R22, it is necessary to choose adequate materials.

CONNECTION PIPE REQUIREMENT

 WARNING
Do not use the existing (for R22) piping and flare nuts.
If the existing materials are used, the pressure inside the refrigerant cycle will rise and cause failure, injury, etc. (Use the special R410A materials.)
When installing and relocating the air conditioner, do not mix gases other than the specified refrigerant (R410A) to enter the refrigerant cycle.
If air or other gas enters the refrigerant cycle, the pressure inside the cycle will rise to an abnormally high value and cause failure, injury, etc.

2.3. For authorized service personnel only.

⚠ WARNING

For the air conditioner to operate satisfactorily, install it as outlined in this installation manual.

Connect the indoor unit and outdoor unit or branch box with the air conditioner piping and cables available from your local distributor. This installation manual describes the correct connections using the installation set available from your local distributor.

Installation work must be performed in accordance with national wiring standards by authorized personnel only.

Do not turn on the power until all installation work is complete.









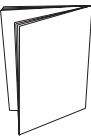

⚠ CAUTION

This installation manual describes how to install the indoor unit only. To install the outdoor unit, refer to the installation manual included with the outdoor unit or branch box.

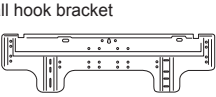
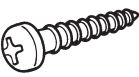
- Be careful not to scratch the air conditioner when handling it.
- After installation, explain correct operation to the customer, using the operating manual.

2.4. Accessories

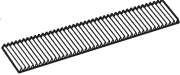
The following installation accessories are supplied. Use them as required.

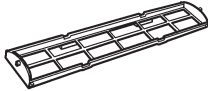
Name and Shape	Q'ty	Name and Shape	Q'ty
Operating Manual 	1	Drain hose insulation 	1
Installation Manual (This manual) 	1	Cloth tape 	1
Wall hook bracket 	1	Tapping screw (large) 	8
Remote controller 	1	Tapping screw (small) 	2
Battery 	2	Air cleaning filter 	2
Remote controller holder 	1	Air cleaning filter frame 	2

The following items are necessary to install this air conditioner. (The items are not included with the air conditioner and must be purchased separately.)

Name	Q'ty	Name	Q'ty
Connection pipe assembly	1	Saddle	1 set
Connection cable (4-conductor)	1	Drain hose	1
Wall pipe	1	Tapping screws	1 set
Decorative tape	1	Sealant	1
Vinyl tape	1	M10 bolt, nut	4 set
Wall cap	1		

2.5. Optional parts

Refer to each installation manual for the method of installing optional parts.

Parts name	Model No.	Application
Wired Remote Controller	UTY-RNN*M	For air conditioner operation
Simple Remote Controller	UTY-RSN*M	For air conditioner operation
External connect kit	UTY-XWZX	For control input/output port

3. GENERAL

This INSTALLATION MANUAL briefly outlines where and how to install the air conditioning system. Please read over the entire set of instructions for the indoor and outdoor units and make sure all accessory parts listed are with the system before beginning.

3.1. Type of copper pipe and insulation material

⚠ CAUTION

Refer to the installation manual for the outdoor unit for description of allowable pipe length and height difference.

Model type	Diameter	
	Liquid pipe	Gas pipe
18L	6.35 mm (1/4 in.)	12.70 mm (1/2 in.)
24L	6.35 mm (1/4 in.)	15.88 mm (5/8 in.)
30L	9.52 mm (3/8 in.)	15.88 mm (5/8 in.)

⚠ CAUTION

Install heat insulation around both the gas and liquid pipes. Failure to do so may cause water leaks.

Use heat insulation with heat resistance above 120 °C. Reverse cycle model only
In addition, if the humidity level at the installation location of the refrigerant piping is expected to exceed 70%, install heat insulation around the refrigerant piping. If the expected humidity level is 70-80%, use heat insulation that is 15 mm or thicker and if the expected humidity exceeds 80%, use heat insulation that is 20 mm or thicker.
If heat insulation is used that is not as thick as specified, condensation may form on the surface of the insulation. In addition, use heat insulation with heat conductivity of 0.045 W/(m·K) or less (at 20 °C).

3.2. Additional materials required for installation

- Refrigeration (armored) tape
- Insulated staples or clamps for connecting wire (See your local electrical codes.)
- Putty
- Refrigeration lubricant
- Clamps or saddles to secure refrigerant piping

4. ELECTRICAL REQUIREMENT

The indoor unit is powered from the outdoor unit or branch box. Do not power indoor unit from separate power source.

⚠ WARNING

Refer to local codes for acceptable cable type.

5. SELECTING THE MOUNTING POSITION

Decide the mounting position with the customer as follows:

- (1) Install the indoor unit level on a strong wall which is not subject to vibration.
- (2) The inlet and outlet ports should not be obstructed : the air should be able to blow all over the room.
- (3) Install the unit a dedicated electrical branch circuit.
- (4) Do not install the unit where it will be exposed to direct sunlight.
- (5) Install the unit where connection to the outdoor unit or branch box is easy.
- (6) Install the unit where the drain pipe can be easily installed.
- (7) Take servicing, etc. into consideration and leave the spaces shown in [6.1. Installation dimensions]. Also install the unit where the filter can be removed.

Correct initial installation location is important because it is difficult to move unit after it is installed.

⚠ WARNING

Select installation locations that can properly support the weight of the indoor. Install the units securely so that they do not topple or fall.

⚠ CAUTION

Do not install the unit in the following areas:

- Area with high salt content, such as at the seaside. It will deteriorate metal parts, causing the parts to fail or the unit to leak water.
- Area filled with mineral oil or containing a large amount of splashed oil or steam, such as a kitchen. It will deteriorate plastic parts, causing the parts to fail or the unit to leak water.
- Area that generates substances that adversely affect the equipment, such as sulfuric gas, chlorine gas, acid, or alkali. It will cause the copper pipes and brazed joints to corrode, which can cause refrigerant leakage.
- Area that can cause combustible gas to leak, contains suspended carbon fibers or flammable dust, or volatile inflammables such as paint thinner or gasoline. If gas leaks and settles around the unit, it can cause a fire.
- Area where animals may urinate on the unit or ammonia may be generated.

Do not use the unit for special purposes, such as storing food, raising animals, growing plants, or preserving precision devices or art objects. It can degrade the quality of the preserved or stored objects.

Do not install where there is the danger of combustible gas leakage.

Do not install the unit near a source of heat, steam, or flammable gas.

Install the unit where drainage does not cause any trouble.

Install the indoor unit, outdoor unit, branch box, power supply cable, transmission cable, and remote control cable at least 1 m away from a television or radio receivers. The purpose of this is to prevent TV reception interference or radio noise. (Even if they are installed more than 1 m apart, you could still receive noise under some signal conditions.)

If children under 10 years old may approach the unit, take preventive measures so that they cannot reach the unit.

Install the indoor unit on the wall where the height from the floors more than 1800 mm.

6. INSTALLATION WORK

6.1. Installation dimensions

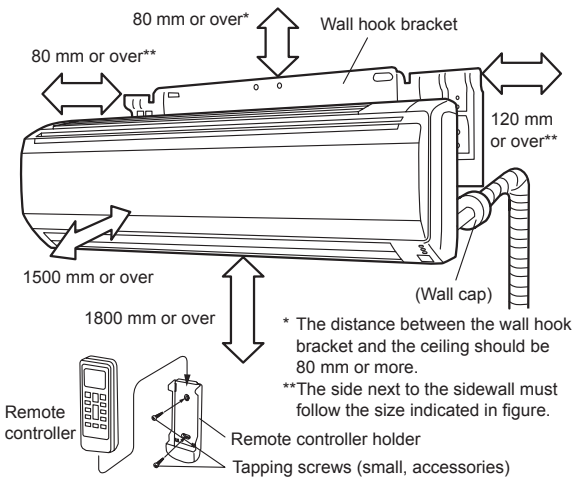

6.2. Indoor unit piping direction

The piping can be connected in the 7 directions in the figure. When the piping is connected in direction ②, ③, ④ or ⑤, cut along the piping groove in the side of the front panel with a hacksaw.

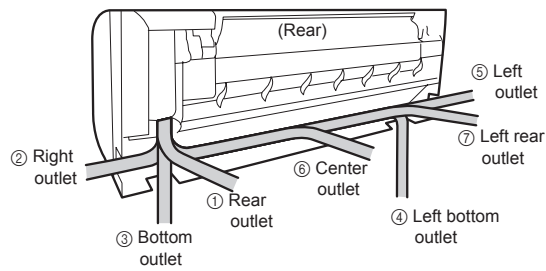

6.3. Cutting the hole in the wall for the connecting piping

- (1) Cut a 80 mm diameter hole in the wall at the position shown in the figure.
- (2) When cutting the wall hole at the inside of the wall hook bracket, cut the hole to a point of intersection of center marks. When cutting the wall hole at the outside of the wall hook bracket, cut the hole at a point of 10 mm below.
- (3) Cut the hole so that the outside end is lower (5 to 10 mm) than the inside end.
- (4) Always align the center of the wall hole. If misaligned, water leakage will occur.
- (5) Cut the wall pipe to match the wall thickness, stick it into the wall cap, fasten the cap with vinyl tape, and stick the pipe through the hole.
- (6) For left piping and right piping, cut the hole a little lower so that drain water will flow freely.

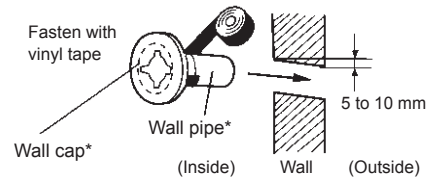
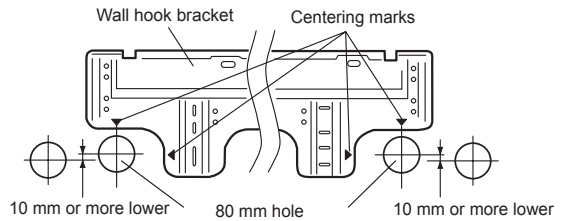

*Locally purchased

⚠ WARNING

If the wall pipe is not used, the cable interconnecting the indoor unit(s) and outdoor unit or branch box may touch metal and cause electric discharge.

6.4. Installing the wall hook bracket

- (1) Install the wall hook bracket so that it is correctly positioned horizontally and vertically. If the wall hook bracket is tiled, water will drip to the floor.
- (2) Install the wall hook bracket so that it is strong enough to support the weight of the unit.
 - Fasten the wall hook bracket to the wall with 6 or more screws through the holes near the outer edge of the bracket.
 - Check that there is no rattle at the wall hook bracket.

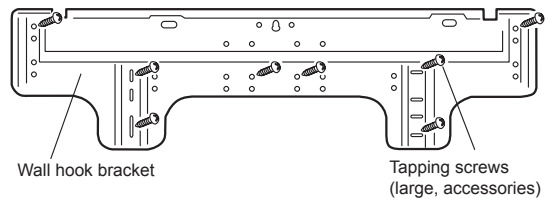

⚠ CAUTION

Install the wall hook bracket level, both horizontally and vertically.

6.5. Forming the drain hose and pipe

[Rear piping, Right piping, Bottom piping]

- Install the indoor unit piping in the direction of the wall hole and bind the drain hose and pipe together with vinyl tape.
- Install the piping so that the drain hose is at the bottom.
- Wrap the pipes of the indoor unit that are visible from the outside with decorative tape.

[For Left rear piping, Left piping]

Interchange the drain cap and the drain hose.

⚠ CAUTION

Insert drain hose and drain cap securely. Drain should slope down to avoid water leakage.

When inserting, be sure not to attach any material besides water. If any other material is attached, it will cause deterioration and water leakage.

After removing drain hose, be sure not to forget mounting drain cap.

Be sure to fix the drain hose with tape to the bottom of piping.

Prevent drain water freezing under low temperature environment.

When installing indoor unit's drain hose outdoors, necessary measure for frost protection should be taken to prevent drain water freezing.

Under low temperature environment (when outdoor temperature under 0 °C), after cooling operation is executed, water in the drain hose could be frozen. Once drain water is frozen, the drain hose will be blocked and water leakage may result at the indoor unit.

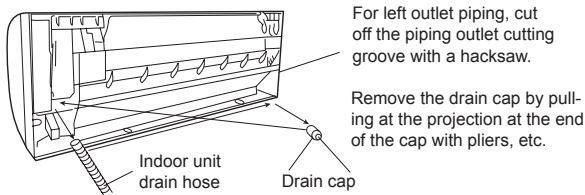
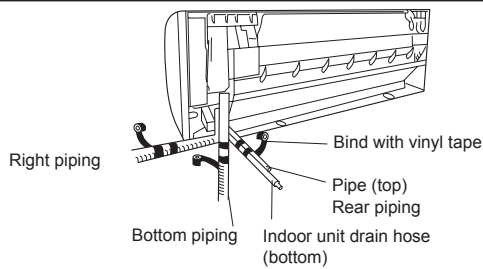

⚠ CAUTION

Insert the drain hose and drain cap into the drain port, making sure that it comes in contact with the back of the drain port, and then mount it. If the drain hose is not connected properly, leaking will occur.

- Attach the Drain hose insulation to the drain hose.

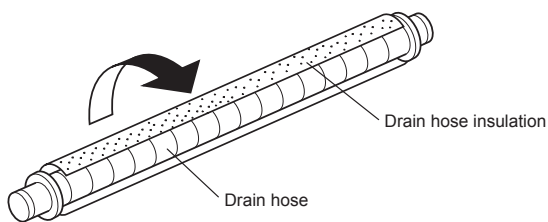

- For left piping and left rear piping, align the marks on the wall hook bracket and shape the connection pipe.
- Bend the connection piping at the bend radius of 100 mm or more and install no more than 35 mm from the wall.
- After passing the indoor piping and drain hose through the wall hole, hang the indoor unit on the hooks at the top and bottom of the wall hook bracket.

[Installing the indoor unit]

- Hang the indoor unit from the hooks at the top of the wall hook bracket.
- Insert the spacer, etc. between the indoor unit and the wall hook bracket and separate the bottom of the indoor unit from the wall.

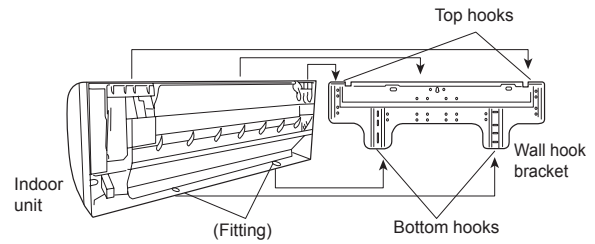
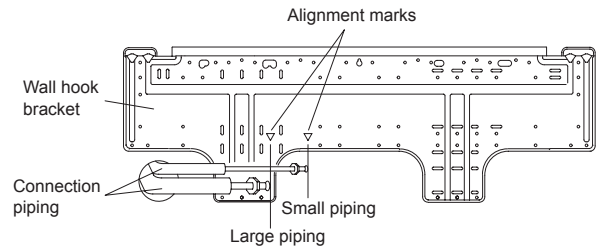
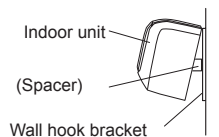

After hooking the indoor unit to the top hook, hook the fittings of the indoor unit to the 2 bottom hooks while lowering the unit and pushing it against the wall.

6.6. Flare connection (Pipe connection)

⚠ WARNING

Tighten the flare nuts with a torque wrench using the specified tightening method. Otherwise, the flare nuts could break after a prolonged period, causing refrigerant to leak and generate hazardous gas if the refrigerant comes into contact with a flame.

6.6.1. Flaring

Use special pipe cutter and flare tool exclusive for R410A.

- (1) Cut the connection pipe to the necessary length with a pipe cutter.
- (2) Hold the pipe downward so that cuttings will not enter the pipe and remove any burrs.
- (3) Insert the flare nut (always use the flare nut attached to the indoor unit(s) and outdoor unit or branch box respectively) onto the pipe and perform the flare processing with a flare tool. Use the special R410A flare tool, or the conventional flare tool. Leakage of refrigerant may result if other flare nuts are used.
- (4) Protect the pipes by pinching them or with tape to prevent dust, dirt, or water from entering the pipes.

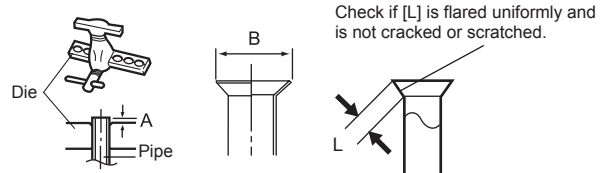

Pipe outside diameter [mm (in.)]	Dimension A [mm]	Dimension B ^① [mm]
	Flare tool for R410A, clutch type	
6.35 (1/4)	0 to 0.5	9.1
9.52 (3/8)		13.2
12.70 (1/2)		16.6
15.88 (5/8)		19.7
19.05 (3/4)		24.0

When using conventional flare tools to flare R410A pipes, the dimension A should be approximately 0.5 mm more than indicated in the table (for flaring with R410A flare tools) to achieve the specified flaring. Use a thickness gauge to measure the dimension A.

Width across flats	Pipe outside diameter [mm (in.)]	Width across flats of Flare nut [mm]
⌀	6.35 (1/4)	17
⌀	9.52 (3/8)	22
⌀	12.70 (1/2)	26
⌀	15.88 (5/8)	29
⌀	19.05 (3/4)	36

6.6.2. Bending pipes

- If pipes are shaped by hand, be careful not to collapse them.
- Do not bend the pipes in an angle more than 90°.
- When pipes are repeatedly bend or stretched, the material will harden, making it difficult to bend or stretch them any more.
- Do not bend or stretch the pipes more than 3 times.

⚠ CAUTION
To prevent breaking of the pipe, avoid sharp bends.
If the pipe is bent repeatedly at the same place, it will break.

6.6.3. Pipe connection

⚠ CAUTION
Be sure to install the pipe against the port on the indoor unit correctly. If the centering is improper, the flare nut cannot tighten smoothly. If the flare nut is forced to turn, the threads will be damaged.
Do not remove the flare nut from the indoor unit pipe until immediately before connecting the connection pipe.
Hold the torque wrench at its grip, keeping it in the right angle with the pipe, in order to tighten the flare nut correctly.
Tighten the flare nuts with a torque wrench using the specified tightening method. Otherwise, the flare nuts could break after a prolonged period, causing refrigerant to leak and generate hazardous gas if the refrigerant comes into contact with a flame.
Connect the piping so that the control box cover can easily be removed for servicing when necessary.
In order to prevent water from leaking into the control box, make sure that the piping is well insulated.

When the flare nut is tightened properly by your hand, hold the body side coupling with a wrench, then tighten with a torque wrench. (See the table below for the flare nut tightening torques.)

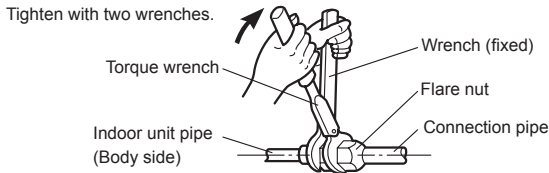

Flare nut [mm (in.)]	Tightening torque [N·m (kgf·cm)]
6.35 (1/4) dia.	16 to 18 (160 to 180)
9.52 (3/8) dia.	32 to 42 (320 to 420)
12.70 (1/2) dia.	49 to 61 (490 to 610)
15.88 (5/8) dia.	63 to 75 (630 to 750)
19.05 (3/4) dia.	90 to 110 (900 to 1,100)

7. ELECTRICAL WIRING

Cable	Cable size (mm ²)	Type	Remarks
Connection cable	1.5	Type 60245 IEC57	3Cable+Earth (Ground), 1φ230V

Max. Cable Length: Limit voltage drop to less than 2%. Increase cable gauge if voltage drop is 2% or more.

7.1. Wiring system diagram

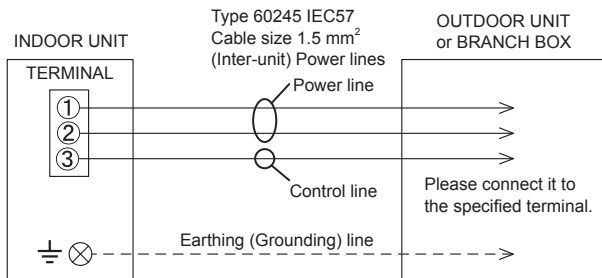

⚠ CAUTION
Every wire must be connected firmly.
No wire should be allowed to touch refrigerant tubing, the compressor or any moving part.
Loose wiring may cause the terminal to overheat or result in unit malfunction. A fire hazard may also exist. Therefore, be sure all wiring is tightly connected.
Connect wires to the matching numbers of terminals.

7.2. Indoor unit wiring

- (1) Remove the cable clamp.
- (2) Bend the end of the connection cable as shown in the figure.
- (3) Connect the end of the connection cable fully inserting into the terminal block.
- (4) Fasten the connection cable with a cable clamp.

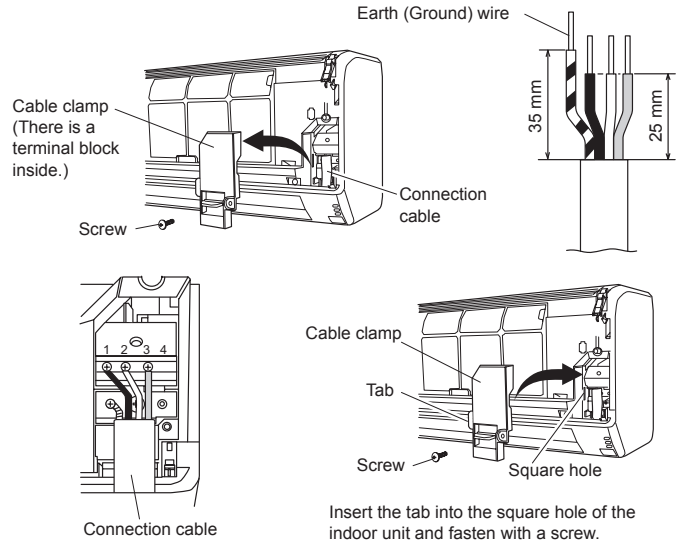

7.3. How to connect wiring to the terminals

Caution when wiring cable

When stripping off the insulation of a lead wire, always use a special tool such as a wire stripper. If there is no special tool available, carefully strip the insulation with a knife etc.

- (1) Use ring terminals with insulating sleeves as shown in the figure below to connect to the terminal block.
- (2) Securely clamp the ring terminals to the wires using an appropriate tool so that the wires do not come loose.

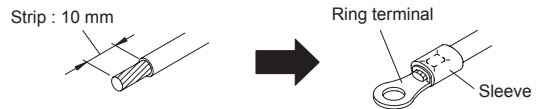

- (3) Use the specified wires, connect them securely, and fasten them so that there is no stress placed on the terminals.
- (4) Use an appropriate screwdriver to tighten the terminal screws. Do not use a screwdriver that is too small, otherwise, the screw heads may be damaged and prevent the screws from being properly tightened.
- (5) Do not tighten the terminal screws too much, otherwise, the screws may break.

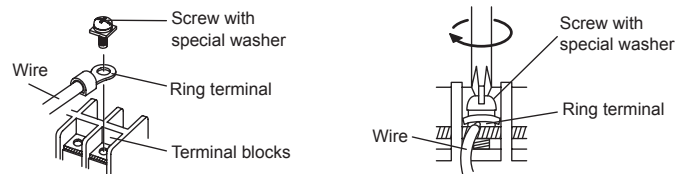

- (6) See the table for the terminal screw tightening torques.

Tightening torque [N·m (kgf·cm)]	
M4 screw	1.2 to 1.8 (12 to 18)

⚠ CAUTION
Match the terminal block numbers and connection cable colors with those of the outdoor unit or branch box. Erroneous wiring may cause burning of the electric parts.
Connect the connection cables firmly to the terminal block. Imperfect installation may cause a fire.
Always fasten the outside covering of the connection cable with the cable clamp. (If the insulator is chafed, electric discharge may occur.)
Always connect the earth (ground) wire.
Do not use the earth (ground) screw of the indoor unit for the connection other than a specified outdoor unit or branch box.

8. FINISHING

(1) Insulate between pipes.

- Insulate suction and discharge pipes separately.
 - For rear, right, and bottom piping, overlap the connection pipe heat insulation and indoor unit pipe heat insulation and bind them with vinyl tape so that there is no gap.
 - For left and left rear piping, butt the connection pipe heat insulation and indoor unit pipe heat insulation together and bind them with and vinyl tape so that there is no gap.
 - For left and left rear piping, wrap the area which accommodates the rear piping housing section with cloth tape.
 - For left and left rear piping, bind the connection cable to the top of the pipe with vinyl tape.
 - For left and left rear piping, bundle the piping and drain hose together by wrapping them with cloth tape over the range within which they fit into the rear piping housing section.
- (2) Temporarily fasten the connection cable along the connection pipe with vinyl tape.
(Wrap to about 1/3 the width of the tape from the bottom of the pipe so that water does not enter.)
- (3) Fasten the connection pipe to the outside wall with saddles, etc.
- (4) Fill the gap between the outside wall pipe hole and the pipe with sealer so that rain water and wind cannot blow in.
- (5) Fasten the drain hose to the outside wall, etc.

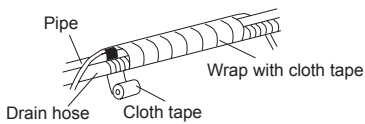
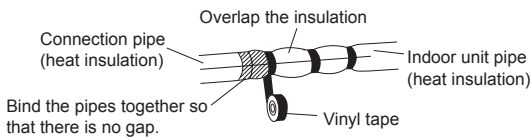
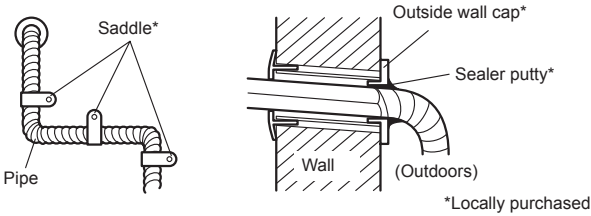

Left piping

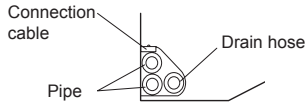

For connection from the left rear

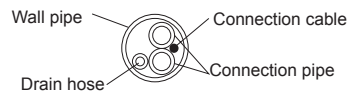

Check the following:

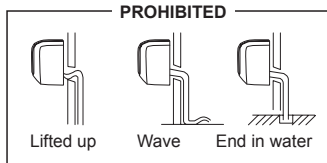
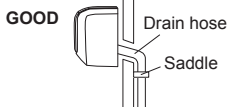

9. FRONT PANEL REMOVAL AND INSTALLATION

9.1. Intake grille removal

- (1) Open the intake grille.
- (2) Pull down the knob.
- (3) Lift the intake grille upward, until the axle at the top of the intake grille is removed.

9.2. Intake grille installation

- (1) The fixing axle of the intake grille is installed on the Panel.
- (2) Lay down the intake grille.

9.3. Front panel removal

- (1) Remove intake grille (Reference the intake grille removal.)
- (2) Remove the 6 screws.
- (3) The thumb is hung on the lower part as shown in the figure, and it pulls to the front, pushing [▲] mark, and bottom hooks (2 positions) is removed from wall hook bracket.
- (4) The front panel is pulled to the front, raising the upper surface, and a front panel is removed.

9.4. Front panel installation

- (1) First, fit the lower part of the front panel, and insert top and bottom hooks. (Three top sides)
- (2) Attach the 6 screws.
- (3) Attach the intake grille.

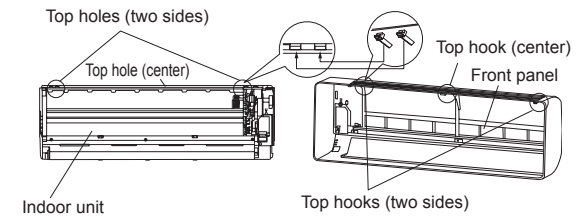
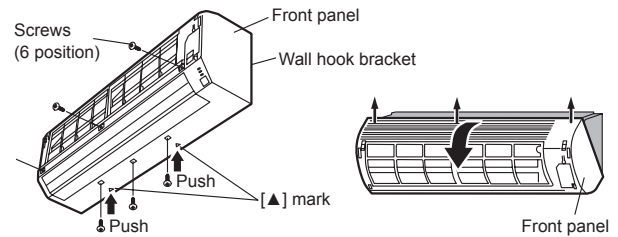
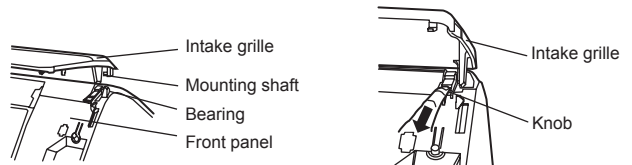

CAUTION

Install the front panel and INTAKE GRILLE securely. If installation is imperfect, the front panel or INTAKE GRILLE may fall off and cause injury.

10. TEST RUN

⚠ WARNING

Do not turn on the power until all installation work is complete.

⚠ CAUTION

When restarting after a long period of disuse in the winter, turn the power switch on at least 12 hours before starting the unit.

Check items

- (1) Is operation of each button on the remote controller normal?
- (2) Does each lamp light normally?
- (3) Do air flow direction louvers operate normally?
- (4) Is the drain normal?
- (5) Do not have an error noise and vibration during operation?
- Do not operate the air conditioner in test run for a long time.

[Operation method]

- For the operation method, refer to the operating manual.
- The outdoor unit may not operate depending on the room temperature. In this case, press the test run button on the remote controller while the air conditioner is running. (Point the transmitter section of the remote controller toward the air conditioner and press the test run button with the tip of a ballpoint pen, etc.)
- To end test operation, press the remote controller START/STOP button. (When the air conditioner is running by pressing the test run button, the OPERATION Lamp and TIMER Lamp will simultaneously flash slowly.)

[Using the wired remote control] (Option)

- For the operation method, refer to the operating manual.
- (1) Stop the air conditioner operation.
 - (2) Press the master control button and the fan control button simultaneously for 2 seconds or more to start the test run.
 - (3) Press the start/stop button to stop the test run.

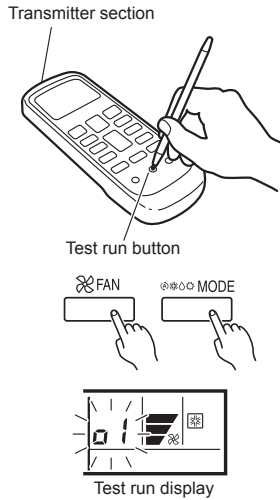

11. REMOTE CONTROLLER INSTALLATION

⚠ CAUTION

Check that the indoor unit correctly receives the signal from the remote controller, then install the remote controller holder.

Select the remote controller holder selection site by paying careful attention to the following:

Avoid places in direct sunlight.

Select a place that will not be affected by the heat from a stove, etc.

11.1. Remote controller holder installation

- Install the remote controller a maximum distance of 7 m from the remote control receiver. However, when installing the remote controller, check that it operates correctly.
- Install the remote controller holder to a wall, pillar, etc. with the tapping screw.

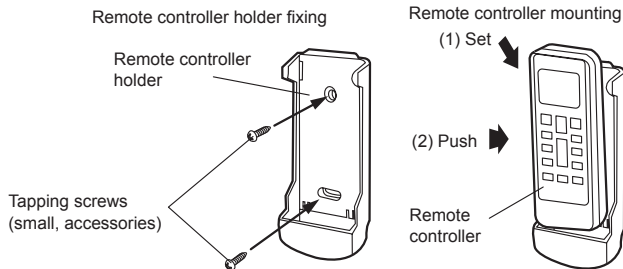

12. OPTIONAL KIT INSTALLATION (OPTION)

This air conditioner can be connected with the following optional kits. Refer to each installation manual for the method of installing parts.

- Wired remote controller
- Simple remote controller
- External connect kit

12.1. Before install optional remote controller

- When you use optional remote controller, some functions may not be used.
- Please use the recommended optional remote controller.

⚠ CAUTION

Before installing, be sure to disconnect all power supply.

Don't touch the heat exchanger.

During installing or removing operation, be sure not to have wire caught by parts or draw it hard. Or it may result troubles to the air-conditioner.

Avoid place in direct sunlight.

Select place that will not be affected by the heat from a stove, etc.

Before setting up the optional kit, please confirm whether air-conditioner can receive the signal.

Do not connect the optional remote controller to the terminal for power supply.

When connecting the optional remote controller with the indoor unit, please use the connecting cable packaged up with the optional remote controller.

Recommended cable length of optional remote controller is 10 m. Make sure to do insulate of connecting part when extended the cable.

12.2. Remote controller cable modification

- (1) Use a tool to cut off the terminal on the end of the remote controller cable, and then remove the insulation from the cut end of the cable.
- (2) Connect the remote controller cable and connecting cable. (Supplied with wired remote controller)

Important: Be sure to solder wires to connect. Be sure to insulate the connection between the wires.

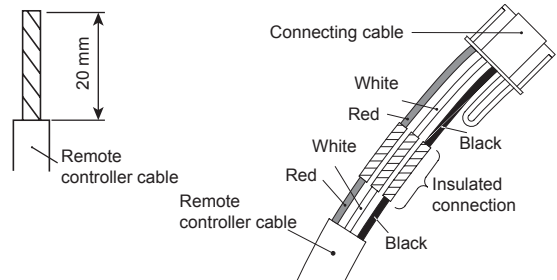

12.3. External input / output Wire modification

- (1) Remove insulation from wire attached to wire kit connector. Remove insulation from field supplied cable. Use crimp type insulated butt connector to join field cable and wire kit wire.
- (2) Connect the wire and Locally purchased wire. (Supplied with external connect kit)

Important:

Be sure to solder wires to connect. Be sure to insulate the connection between the wires.

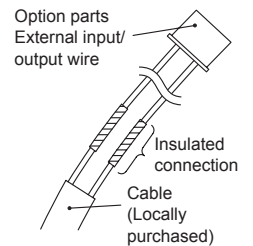

12.4. Front panel, control box cover and display case removal

- (1) Refer to "FRONT PANEL REMOVAL AND INSTALLATION" to remove the front panel.
- (2) Remove the screw then remove the control box cover.
- (3) Remove the display case and connector.

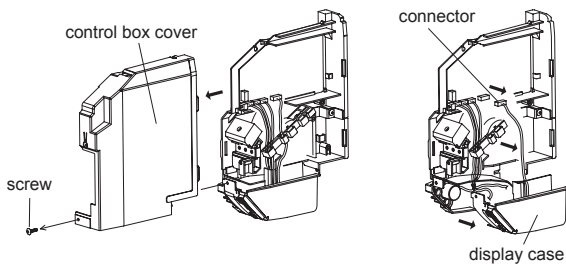

12.5. Connecting cable to control board connector

- (1) Pass the cable from the hole in the back of indoor unit.
- (2) Connect the cable to the control board connector.
- (3) Hook the cable to the rib.

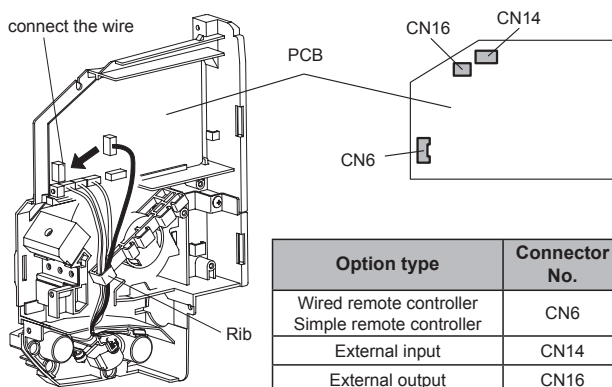
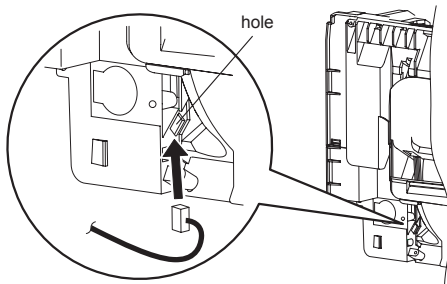

Option type	Connector No.
Wired remote controller	CN6
Simple remote controller	CN6
External input	CN14
External output	CN16

- (4) Use cable clamer and screw to fasten the cable of wired remote controller.

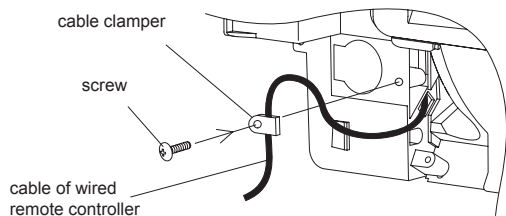

- (5) Fix the cable tie holder with the screw and bind the wire of external kit with the cable tie.

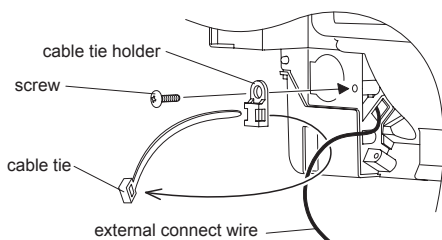

12.6. Front panel, control box cover and display case installation

Install front panel, control box cover and display case by the reverse procedures as stated in 12.4 Front panel, control box cover and display case removal.

13. FUNCTION SETTING

Perform the "FUNCTION SETTING" according to the installation conditions using the remote controller.

CAUTION

- Confirm whether the wiring work for Outdoor unit or Branch box has been finished.
- Confirm that the cover for the electrical enclosure on the outdoor unit is in place.

- This procedure changes to the function settings used to control the indoor unit according to the installation conditions. Incorrect settings can cause the indoor unit to malfunction.
- After the power is turned on, perform the "FUNCTION SETTING" according to the installation conditions using the remote controller.
- The settings may be selected between the following two: Function Number or Setting Value.
- Settings will not be changed if invalid numbers or setting values are selected.
- Refer to the installation manual enclosed with the remote controller when the wired remote controller (option) is used.

Entering the Function Setting Mode

While pressing the FAN button and SET TEMP. (▲) simultaneously, press the RESET button to enter the function setting mode.

STEP 1

Selecting the Remote Controller Custom code

Use the following steps to select the custom code of the remote controller. (Note that the air conditioner cannot receive a signal if the air conditioner has not been set for the matching custom code.)

The custom codes that are set through this process are applicable only to the signals in the FUNCTION SETTING. For details on how to set the custom codes through the normal process, refer to Remote controller custom code.

- (1) Press SET TEMP. (▲) (▼) button to change the custom code between \bar{A} → \bar{b} → \bar{c} → \bar{d} . Match the code on the display to the air conditioner custom code. (Initially set to \bar{A}) (If the custom code does not need to be selected, press the MODE button and proceed to STEP 2.)
- (2) Press the TIMER MODE button and check that the indoor unit can receive signals at the displayed custom code.
- (3) Press the MODE button to accept the custom code, and proceed to STEP 2.

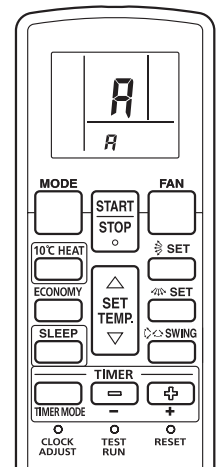

The air conditioner custom code is set to A prior to shipment. Contact your retailer to change the custom code.

The remote controller resets to custom code A when the batteries in the remote controller are replaced. If you use a custom code other than custom code A, reset the custom code after replacing the batteries. If you do not know the air conditioner custom code setting, try each of the custom codes (\bar{A} → \bar{b} → \bar{c} → \bar{d}) until you find the code which operates the air conditioner.

STEP 2

Selecting the Function Number and Setting Value

- (1) Press the SET TEMP. (▲) (▼) buttons to select the function number. (Press the MODE button to switch between the left and right digits.)
- (2) Press the FAN button to proceed to setting the value. (Press the FAN button again to return to the function number selection.)
- (3) Press the SET TEMP. (▲) (▼) buttons to select the setting value. (Press the MODE button to switch between the left and right digits.)
- (4) Press the TIMER MODE button, and START/STOP button, in the order listed to confirm the settings.
- (5) Press the RESET button to cancel the function setting mode.
- (6) After completing the FUNCTION SETTING, be sure to disconnect the power and reconnect it again.

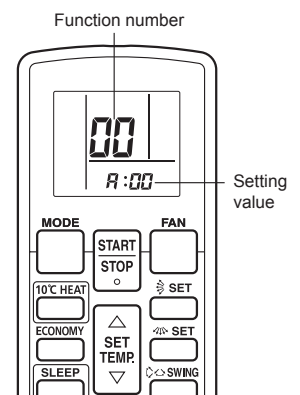

CAUTION

- After disconnecting the power, wait 10 seconds or more before reconnecting it again.
- The Function Setting does not become active unless the power is disconnected then reconnected again.

Filter Sign

The indoor unit has a sign to inform the user that it is time to clean the filter. Select the time setting for the filter sign display interval in the table below according to the amount of dust or debris in the room. If you do not wish the filter sign to be displayed, select the setting value for "No indication".

(... Factory setting)

Setting Description	Function Number	Setting Value
Standard (400 hours)	11	00
Long interval (1,000 hours)		01
Short interval (200 hours)		02
No indication		03

Cooling Room Temperature Correction

Depending on the installed environment, the room temperature sensor may require a correction.

The settings may be selected as shown in the table below.

(... Factory setting)

Setting Description	Function Number	Setting Value
Standard	30	00
Slightly lower control		01
Lower control		02
Warmer control		03

Heating Room Temperature Correction

Depending on the installed environment, the room temperature sensor may require a correction.

The settings may be changed as shown in the table below.

(... Factory setting)

Setting Description	Function Number	Setting Value
Standard	31	00
Lower control		01
Slightly warmer control		02
Warmer control		03

Auto Restart

Enable or disable automatic system restart after a power outage.

(... Factory setting)

Setting Description	Function Number	Setting Value
Yes	40	00
No		01

* Auto restart is an emergency function such as for power failure etc. Do not start and stop the indoor unit by this function in normal operation. Be sure to operate by the control unit, or external input device.

Indoor room temperature sensor switching function

(Only for Wired remote controller)

The following settings are needed when using the Wired remote controller temperature sensor.

(... Factory setting)

Setting Description	Function Number	Setting Value
No	42	00
Yes		01

* If setting value is "00":

Room temperature is controlled by the indoor unit temperature sensor.

* If setting value is "01":

Room temperature is controlled by either indoor unit temperature sensor or remote controller sensor.

Remote controller custom code

Change the indoor unit Custom Code, depending on the remote controllers.

(... Factory setting)

Setting Description	Function Number	Setting Value
A	44	00
B		01
C		02
D		03

External input control

"Operation/Stop" mode or "Forced stop" mode can be elected.

(... Factory setting)

Setting Description	Function Number	Setting Value
Operation/Stop mode	46	00
(Setting forbidden)		01
Forced stop mode		02

Indoor unit fan control for energy saving

Enable or disable indoor unit fan control when the outdoor unit is stopped.

(... Factory setting)

Setting Description	Function Number	Setting Value
No	49	00
Yes		01

Setting record

Record any changes to the settings in the following table.

Setting Description	Setting Value
Filter sign	
Cooling room temperature correction	
Heating room temperature correction	
Auto restart	
Indoor room temperature sensor switching function	
Remote controller custom code	
External input control	
Indoor unit fan control for energy saving	

After completing the FUNCTION SETTING, be sure to disconnect the power and reconnect it again.

Selecting the remote controller custom code

When 2 or more air conditioners are installed in a room and the remote controller is operating an air conditioner other than the one you wish to set, change the custom code of the remote controller to operate only the air conditioner you wish to set (four selections possible).

When two or more air conditioners are installed in a room, please contact your retailer to set the individual air conditioner custom codes.

* Confirm the setting of the remote controller custom code and the function setting. If these are not confirmed, the remote controller cannot be used to operate for the air conditioner.

Selecting the Remote Controller Custom Code

Use the following steps to select the custom code of the remote controller. (Note that the air conditioner cannot receive a custom code if the air conditioner has not been set for the custom code.)

- Press the START/STOP button until only the clock is displayed on the remote controller display.
- Press the MODE button for at least 5 seconds to display the current custom code (initially set to A).
- Press SET TEMP. (▲) (▼) button to change the custom code between A → B → C → D. Match the code on the display to the air conditioner custom code.
- Press the MODE button again to return to the clock display. The custom code will be changed.

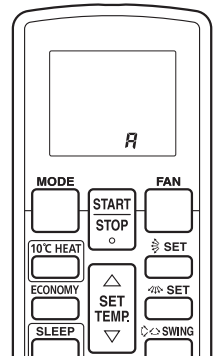

If no buttons are pressed within 30 seconds after the custom code is displayed, the system returns to the original clock display. In this case, start again from step 1.

The air conditioner custom code is set to A prior to shipment. Contact your retailer to change the custom code.

The remote controller resets to custom code A when the batteries in the remote controller are replaced. If you use a custom code other than custom code A, reset the custom code after replacing the batteries.

If you do not know the air conditioner custom code setting, try each of the custom codes (A → B → C → D) until you find the code which operates the air conditioner.

14. CUSTOMER GUIDANCE

Explain the following to the customer in accordance with the operating manual:

- Starting and stopping method, operation switching, temperature adjustment, timer, airflow switching, and other remote control unit operations.
- Air filter removal and cleaning, and how to use the air louvers.
- Give the operating manual to the customer.
- If the custom code is changed, explain to the customer how it changed (the system returns to custom code A when the batteries in the remote controller are replaced).

* (4) is applicable to using wireless remote controller.

15.ERROR CODES

If you use a wireless remote controller, the lamp on the photo detector unit will output error codes by way of blinking patterns. If you use a wired remote controller, error codes will appear on the remote controller display. See the lamp blinking patterns and error codes in the table. An error display is displayed only during operation.

Error display			Wired remote controller Error code	Description
OPERATION lamp (green)	TIMER lamp (orange)	ECONOMY lamp (green)		
●(1)	●(1)	◇	11	Serial communication error
●(1)	●(2)	◇	12	Wired remote controller communication error
●(1)	●(5)	◇	15	Check run unfinished
●(2)	●(1)	◇	21	Unit number or Refrigerant circuit address setting error [Simultaneous Multi]
●(2)	●(2)	◇	22	Indoor unit capacity error
●(2)	●(3)	◇	23	Combination error
●(2)	●(4)	◇	24	• Connection unit number error (indoor secondary unit) [Simultaneous Multi] • Connection unit number error (indoor unit or branch unit) [Flexible Multi]
●(2)	●(7)	◇	27	Primary unit, secondary unit set-up error [Simultaneous Multi]
●(3)	●(2)	◇	32	Indoor unit PCB model information error
●(3)	●(5)	◇	35	Manual auto switch error
●(4)	●(1)	◇	41	Inlet air temp. sensor error
●(4)	●(2)	◇	42	Indoor unit Heat Ex. Middle temp. sensor error
●(5)	●(1)	◇	51	Indoor unit fan motor error
●(5)	●(3)	◇	53	Drain pump error
●(5)	●(7)	◇	57	Damper error
●(5)	●(15)	◇	5U	Indoor unit error
●(6)	●(2)	◇	62	Outdoor unit main PCB model information error or communication error
●(6)	●(3)	◇	63	Inverter error
●(6)	●(4)	◇	64	Active filter error, PFC circuit error
●(6)	●(5)	◇	65	Trip terminal L error
●(6)	●(10)	◇	6A	Display PCB microcomputers communication error
●(7)	●(1)	◇	71	Discharge temp. sensor error
●(7)	●(2)	◇	72	Compressor temp. sensor error
●(7)	●(3)	◇	73	Outdoor unit Heat Ex. liquid temp. sensor error
●(7)	●(4)	◇	74	Outdoor temp. sensor error
●(7)	●(5)	◇	75	Suction Gas temp. sensor error
●(7)	●(6)	◇	76	• 2-way valve temp. sensor error • 3-way valve temp. sensor error
●(7)	●(7)	◇	77	Heat sink temp. sensor error
●(8)	●(2)	◇	82	• Sub-cool Heat Ex. gas inlet temp. sensor error • Sub-cool Heat Ex. gas outlet temp. sensor error
●(8)	●(3)	◇	83	Liquid pipe temp. sensor error

●(8)	●(4)	◇	84	Current sensor error
●(8)	●(6)	◇	86	• Discharge pressure sensor error • Suction pressure sensor error • High pressure switch error
●(9)	●(4)	◇	94	Trip detection
●(9)	●(5)	◇	95	Compressor rotor position detection error (permanent stop)
●(9)	●(7)	◇	97	Outdoor unit fan motor error
●(9)	●(9)	◇	99	4-way valve error
●(10)	●(1)	◇	A1	Discharge temp. error
●(10)	●(3)	◇	A3	Compressor temp. error
●(10)	●(4)	◇	A4	High pressure error
●(10)	●(5)	◇	A5	Low pressure error
●(13)	●(2)	◇	J2	Branch boxes error [Flexible Multi]

Display mode ● : 0.5s ON / 0.5s OFF
◇ : 0.1s ON / 0.1s OFF
() : Number of flashing

[Troubleshooting with the indoor unit display]

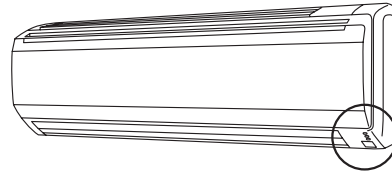

OPERATION — OPERATION lamp (green)
TIMER — TIMER lamp (orange)
ECONOMY — ECONOMY lamp (green)

[Troubleshooting with the Wired Remote Controller Display (Option)]

If an error occurs, the following display will be shown. ("Er" will appear in the set room temperature display.)

