

8. External input and output

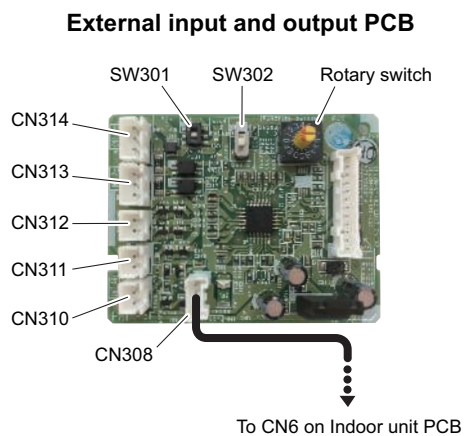

PCB	External input	External output	Connector	Input select	Input signal
External input and output (UTY-XCSXZ2)	Operation/Stop	—	CN313/ CN314	Dry contact/ Apply voltage	Edge/Pulse
	Forced stop		CN313		Edge
	Forced thermostat off			—	—
	—	Operation status	CN310	—	—
	—	Error status	CN311		
	—	Indoor unit fan operation status	CN312		

NOTE: External input and output PCB cannot be used with Wireless LAN adapter simultaneously.

8-1. External input

With using external input function, some functions on this product can be controlled from an external device.

- "Operation/Stop" mode or "Forced stop" mode can be selected with function setting of indoor unit.
- A twisted pair cable should be used. Maximum length of cable is 150 m.
- The wire connection should be separate from the power cable line.

External input and output PCB

The indoor unit Operation/Stop can be set by using the input connector on the PCB.

Input select:

Use either one of these types of connectors according to the application. (Both types of connectors cannot be used simultaneously.)

– Dry contact

In case of internal power supply, set the slide switch of SW301 to "NON VOL" side.

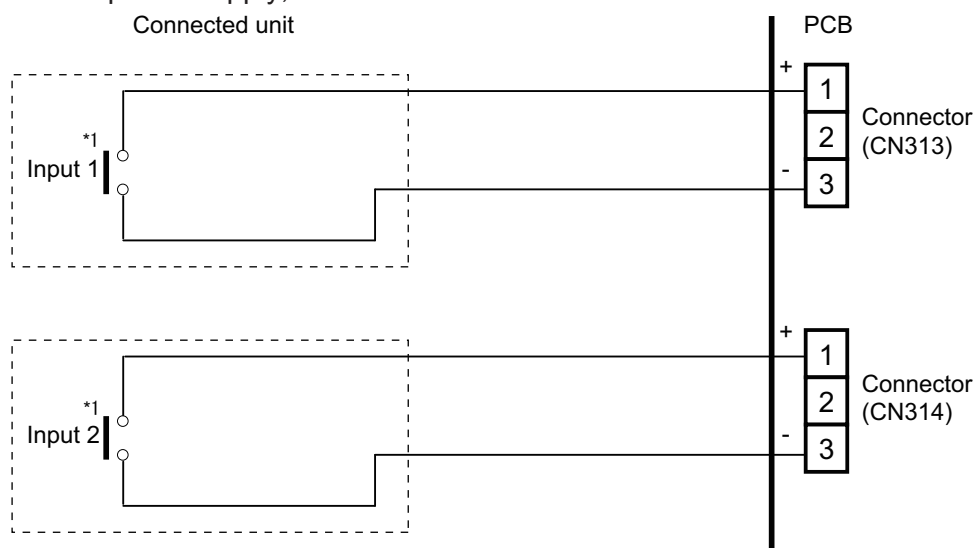

*1: The switches can be used on the following condition: DC 12 V to 24 V, 1 mA to 15 mA.

– Apply voltage

In case of external power supply, set the slide switch of SW301 to "VOL" side.

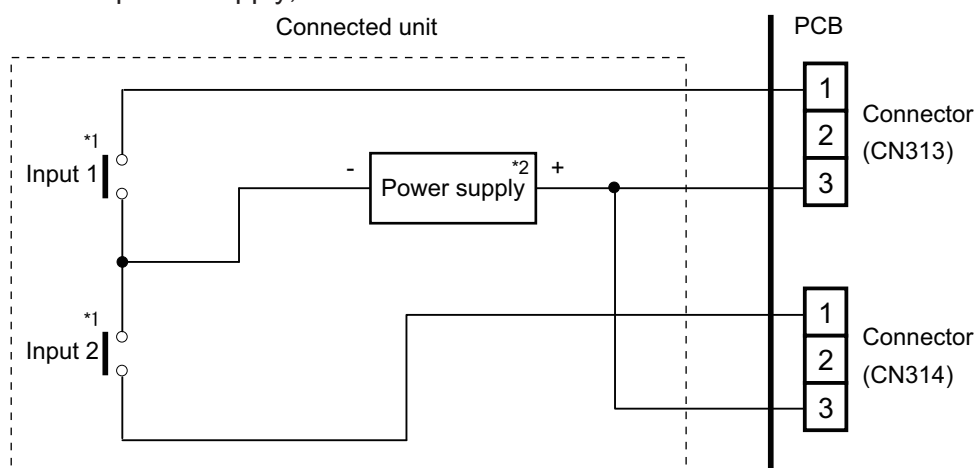

*1: The switches can be used on the following condition: DC 12 V to 24 V, 1 mA to 15 mA.

*2: Make the power supply DC 12 to 24 V, 10 mA or more.

8-2. External output

Use an external output cable with appropriate external dimension, depending on the number of cables to be installed.

External input and output PCB

- A twisted pair cable (22AWG) should be used. Maximum length of cable is 25 m.
- Output voltage: High DC 12 V \pm 2 V, Low 0 V.
- Permissible current: 50 mA
- For details, refer to ["Combination of external input and output"](#) on page 17.

- **When indicator or other components are connected directly:**

Example: Rotary SW on External input and output PCB is set to "1".

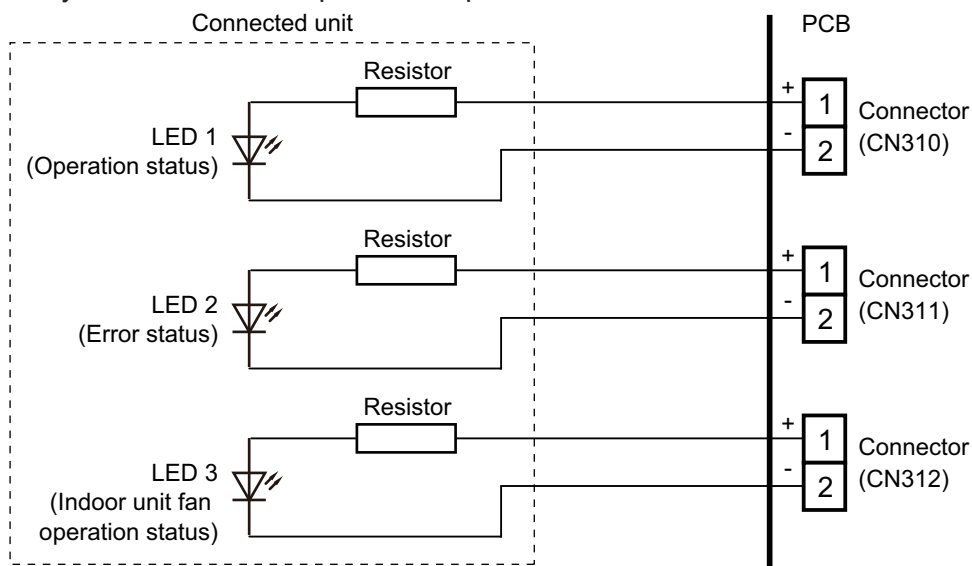

- **When connecting with a device equipped with a power supply:**

Example: Rotary SW on External input and output PCB is set to "1".

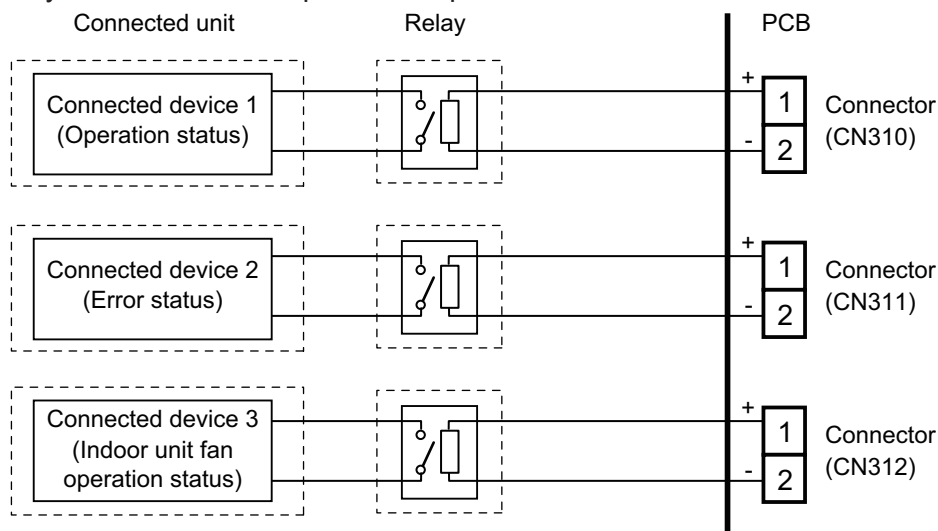

8-3. Combination of external input and output

By combining the function setting of the indoor unit and rotary switch setting of the External input and output PCB, you can select various combinations of functions.

Combination examples of external input and output are as follows:

Mode	External input and output PCB (Rotary SW)	External input		
		External input and output PCB		
		CN313	CN314	Signal type
0-1	1	Operation/Stop	Not available	Edge
		Operation	Stop	Pulse
0-2	2	Forced Thermostat OFF	Not available	Edge
1—8	3 - 9, A	(Setting prohibited)		
9	B	Forced Thermostat OFF	Not available	Edge
10	C	Forced Thermostat OFF	Not available	Edge
11	D	Forced Thermostat OFF	Not available	Edge

Mode	External input and output PCB (Rotary SW)	External output		
		External input and output PCB		
		CN310	CN311	CN312
0-1	1	Operation/Stop	Error status	Indoor unit fan operation status
0-2	2	Error status	Indoor unit fan operation status	Not available
1—8	3 - 9, A	(Setting prohibited)		
9	B	Operation/Stop	Indoor unit fan operation status	Not available
10	C	Operation/Stop	Error status	Not available
11	D	Operation/Stop	Indoor unit fan operation status	Error status

NOTE: Input of Operation/Stop depends on the setting of function setting 46.

00: Operation/Stop mode 1 (R.C. enabled)

01: (Setting prohibited)

02: Forced stop

03: Operation/Stop mode 2 (R.C. disabled)

Input signal type

External input and output PCB:

The input signal type can be selected.

Signal type (edge or pulse) can be switched by the DIP switch SW302 on the External input and output PCB.

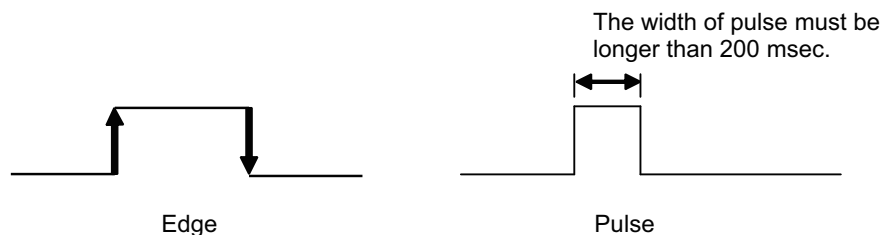

8-4. Details of function

■ Control input function

- When function setting is “Operation/Stop” mode 1
 - In the case of “Edge” input:

Function setting	Rotary SW on External input and output PCB	External input		Input signal	Command
		External input and output PCB	CN313		
46-00	1			Off → On	Operation
				On → Off	Stop

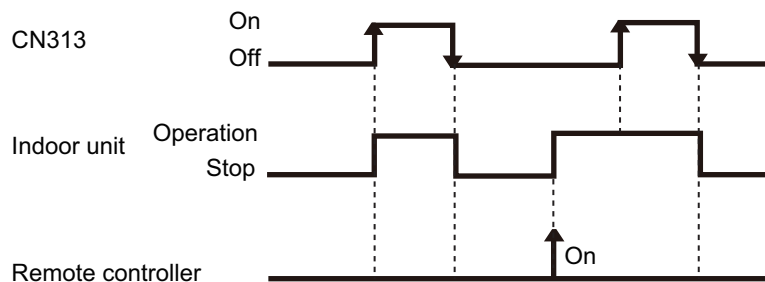

- In the case of “Pulse” input:

Function setting	Rotary SW on External input and output PCB	External input		Input signal	Command
		External input and output PCB	CN313		
46-00	1		CN313	Pulse	Operation
			CN314	Pulse	Stop

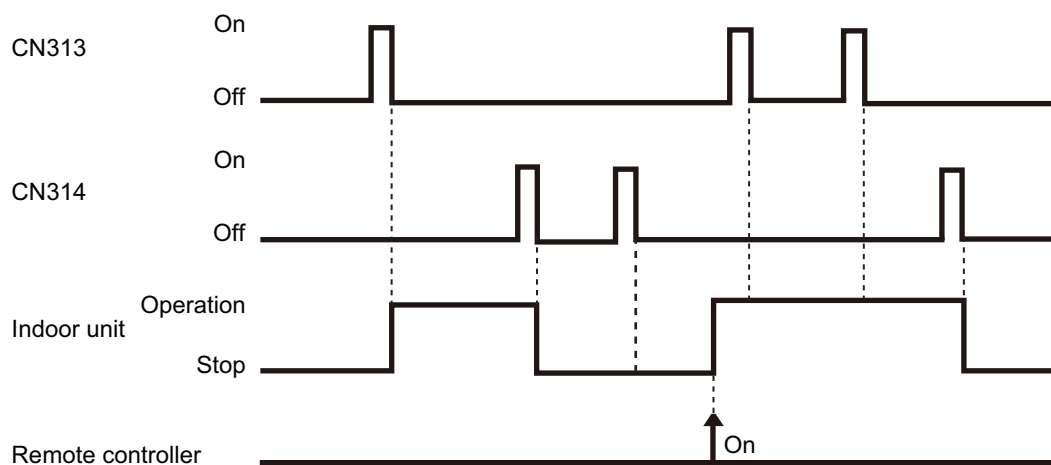

NOTES:

- The last command has priority.
- The indoor units within the same remote controller group operates in the same mode.

• When function setting is “Forced stop” mode

– In the case of “Edge” input:

Function setting	Rotary SW on External input and output PCB	External input		Input signal	Command
		External input and output PCB	CN313		
46-02	1			Off → On	Forced stop
				On → Off	Normal

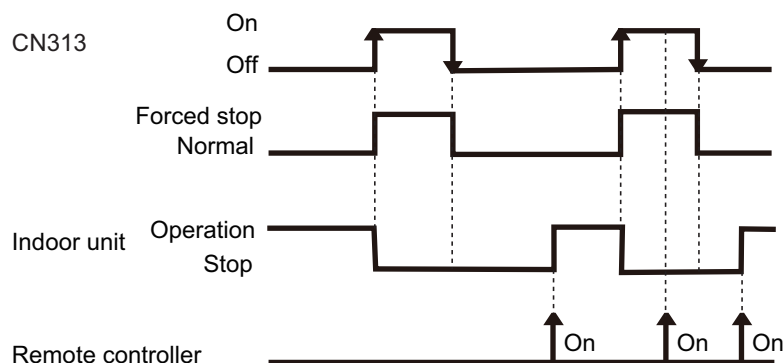

– In the case of “Pulse” input:

Function setting	Rotary SW on External input and output PCB	External input		Input signal	Command
		External input and output PCB	CN313 CN314		
46-02	1		CN313	Pulse	Forced stop
			CN314	Pulse	Normal

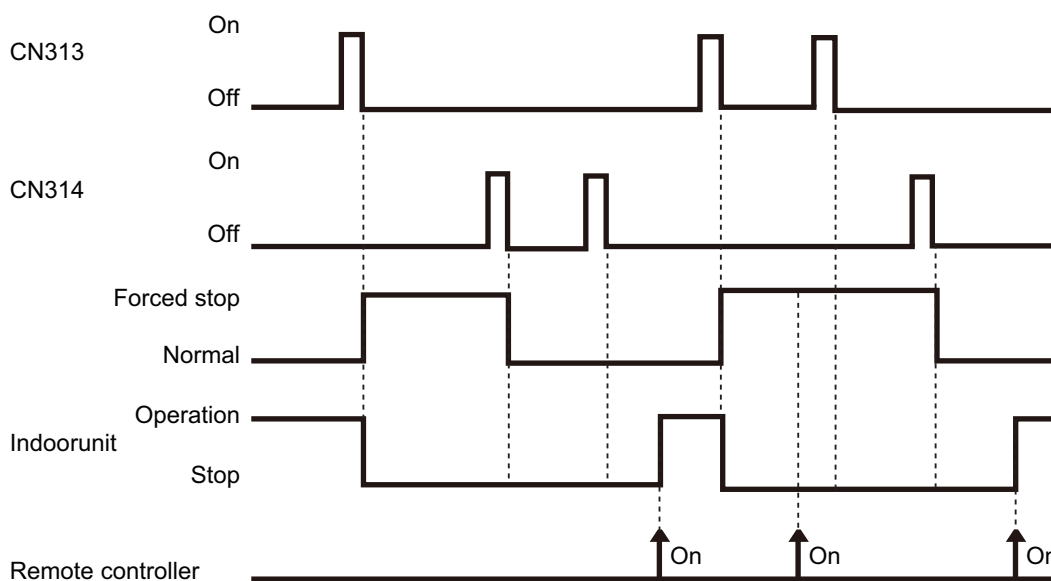

NOTES:

- When the forced stop is triggered, indoor unit stops and Operation/Stop operation by the remote controller is restricted.
- When forced stop function is used with forming a remote controller group, connect the same equipment to each indoor unit within the group.

• When function setting is “Operation/Stop” mode 2

– In the case of “Edge” input:

Function setting	Rotary SW on External input and output PCB	External input		Input signal	Command
46-03	1	External input and output PCB	CN313	Off → On	Operation
				On → Off	Stop (R.C. disabled)

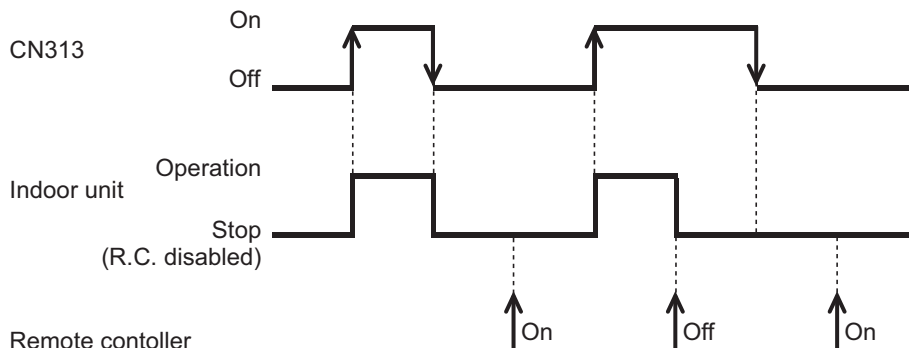

– In the case of “Pulse” input:

Function setting	Rotary SW on External input and output PCB	External input		Input signal	Command
46-03	1	External input and output PCB	CN313	Pulse	Operation
			CN314	Pulse	Stop (R.C. disabled)

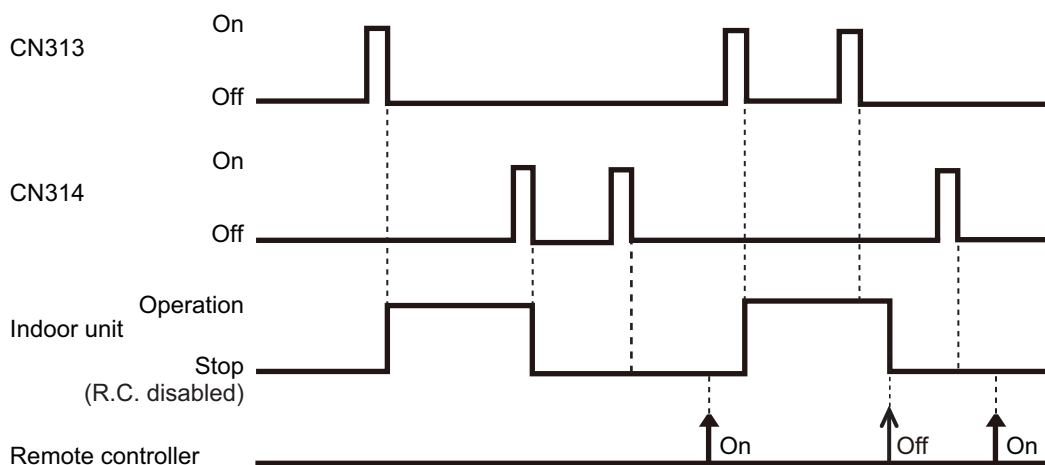

NOTE: When “Operation/Stop” mode 2 function is used with forming a remote controller group, connect the same equipment to each indoor unit within the group.

• Forced thermostat off function

Rotary SW on External input and output PCB	External input		Input signal	Command
2	External input and output PCB	CN313	Off → On	Thermostat off
B			On → Off	Normal operation
C				

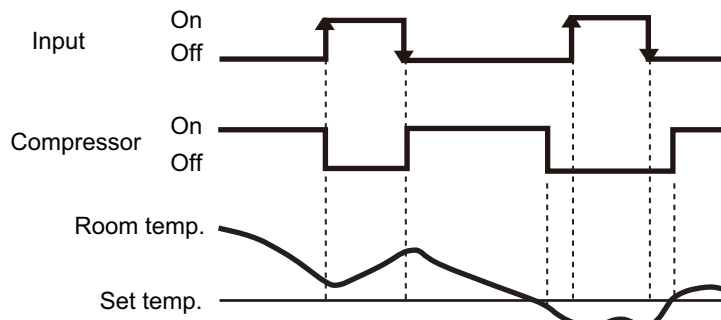

Control output function

• Operation/Stop status

Rotary SW on External input and output PCB	External output		Output signal	Command
1	External input and output PCB	CN310	Off → On	Operation
			On → Off	Stop

The output is low when the unit is stopped.

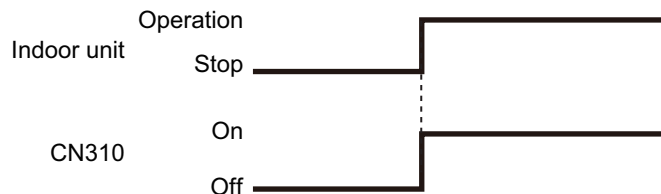

• Error status

Rotary SW on External input and output PCB	External output		Output signal	Command
1	External input and output PCB	CN311	Off → On	Error
			On → Off	Normal

The output is ON when an error is generated for the indoor unit.

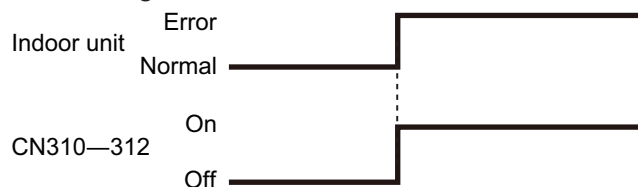

• Indoor unit fan operation status

Rotary SW on External input and output PCB	External output		Output signal	Command
1	External input and output PCB	CN312	Off → On	Fan run
			On → Off	Fan stop

Output signal	Condition
On Low → High	The indoor unit fan is operating.
Off High → Low	The fan is stopped or during cold air prevention. During thermostat off when in dry mode operation.

