

AUXB014GLEH

Please visit our webstore for full product and technical documentation

Unit Type	Compact Cassette	
Remote Controller	Option	
Nominal Cooling Capacity (kW)	4.5	
UK Total Cooling Capacity (kW)	3.3	
UK Sensible Cooling Capacity (kW)	2.7	
Nominal Heating Capacity (kW)	4.7	
UK Heating Capacity (kW)	5.0	
Height (mm)	245	
Width (mm)	570	
Depth (mm)	570	
Weight (kg)	15	
Grille	UTGUFYEW	
Grille Dimensions (HxWxD) (mm)	50 x 620 x 620	
Grille Weight (kg)	2.3	
Airflow Rate - Cooling - High (m3/h)	680	
Sound Pressure Level - Cooling - High (dB(A))	38	
Sound Pressure Level - Cooling - Low (dB(A))	30	
Refrigerant Type (Global Warming Potential)	R410A (2,088)	
Liquid Pipe Size	1/4"	
Gas Pipe Size	1/2"	
Unit Power Supply	1Ph-230V-50Hz	



Document Downloads

- [Air Distribution](#)
- [Airflow](#)
- [Cooling Capacity](#)
- [Dimensional Drawing](#)
- [Electrical Characteristics](#)
- [Heating Capacity](#)
- [Installation Manual](#)
- [Noise Curve](#)
- [Operation Manual](#)

- [Product Image](#)
- [Spare Parts List All Pages](#)
- [Specifications](#)
- [Wiring Diagram](#)

Related Items

- [UTGUFYEW](#) Compact Cassette Grille
- [UTRYDZB](#) Air Outlet Shutter Plate for Compact Cassette
- [UTZVXAA](#) Fresh Air Intake Kit for Compact Cassette
- [UTYRNRZ5](#) Touch Screen Remote Controller
- [UTYRCRYZ1](#) Compact Simple Remote controller
- [UTYRSRY](#) Simple Remote Controller (with Master Control)
- [UTYRHRY](#) Simple Remote Controller (without Master Control)
- [UTYLNHY](#) Wireless Remote Controller
- [UTYTF SXZ1](#) Wireless LAN interface

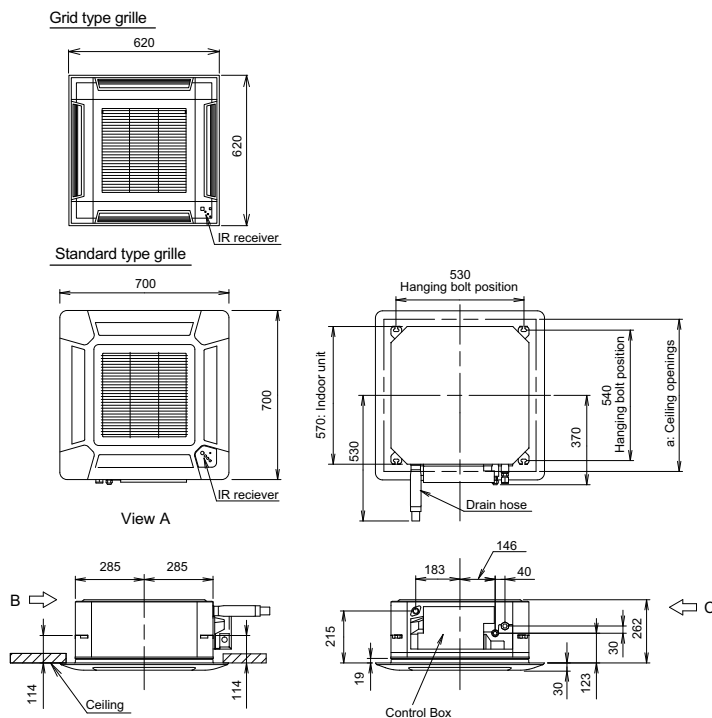

*Specifications and design are subject to change without notice for further improvement.
 •Actual products' colors may be different from the colors shown in this printed material.