

AIR CONDITIONER

Compact cassette type

INSTALLATION MANUAL



PART No. 9379124119-05

[Original instructions]

For authorized service personnel only.

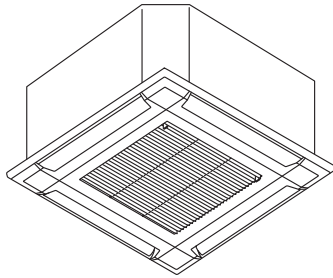

Contents

| | |
|---|----|
| 1. SAFETY PRECAUTIONS..... | 1 |
| 1.1. Precautions for using R32 refrigerant..... | 2 |
| 2. PRODUCT SPECIFICATION..... | 4 |
| 2.1. Installation tools..... | 4 |
| 2.2. Accessories..... | 4 |
| 2.3. Cassette grille accessories..... | 4 |
| 2.4. Pipe requirement..... | 5 |
| 2.5. Electrical requirement..... | 5 |
| 2.6. Optional parts..... | 5 |
| 3. INSTALLATION WORK..... | 5 |
| 3.1. Selecting an installation location..... | 5 |
| 3.2. Installation dimensions..... | 5 |
| 3.3. Installing the unit..... | 6 |
| 3.4. Drain installation..... | 6 |
| 3.5. Pipe installation..... | 7 |
| 3.6. Electrical wiring..... | 8 |
| 3.7. Remote controller setting..... | 11 |
| 4. CASSETTE GRILLE INSTALLATION..... | 11 |
| 4.1. Remove the intake grille..... | 11 |
| 4.2. Installing the panel to indoor unit..... | 11 |
| 4.3. Attach the intake grille..... | 12 |
| 5. OPTIONAL INSTALLATION WORK..... | 12 |
| 5.1. Optional kit installation..... | 12 |
| 5.2. External input and output..... | 12 |
| 5.3. Remote sensor (Optional parts)..... | 13 |
| 5.4. Other optional parts..... | 13 |
| 5.5. Optional parts cable binding..... | 13 |
| 6. REMOTE CONTROL INSTALLATION..... | 14 |
| 6.1. Group control..... | 14 |
| 6.2. Multiple remote control..... | 15 |
| 6.3. Simultaneous multi-system operation..... | 15 |
| 7. FUNCTION SETTING..... | 16 |
| 7.1. Function details..... | 16 |
| 8. CHECK LIST..... | 18 |
| 9. TEST RUN..... | 18 |
| 9.1. Check items..... | 18 |
| 9.2. Operation method..... | 18 |
| 10. FINISHING..... | 18 |
| 10.1. Installing heat insulation..... | 18 |
| 11. CUSTOMER GUIDANCE..... | 18 |
| 12. ERROR CODES..... | 18 |

NOTES: This manual describes how to install the air conditioner described above. Handling and installation shall only be done by professionals as outlined in this manual.

1. SAFETY PRECAUTIONS

- Be sure to read this manual thoroughly before installation.
- The warnings and precautions indicated in this manual contain important information pertaining to your safety. Be sure to observe them.
- Hand this manual, together with the operating manual, to the customer. Request the customer to keep them on hand for future use, such as for relocating or repairing the unit.

WARNING

Indicates a potentially or imminently hazardous situation which, if not avoided, could result in death or serious injury.

CAUTION

Indicates a potentially hazardous situation that may result in minor or moderate injury or damage to property.

WARNING

- The appliance shall be installed, operated and stored in a room with a floor area larger than X m²

| Amount of refrigerant charge M (kg) | Minimum room area X (m ²) |
|--|--|
| M ≤ 1.22 | - |
| 1.22 < M ≤ 1.23 | 1.45 |
| 1.23 < M ≤ 1.50 | 2.15 |
| 1.50 < M ≤ 1.75 | 2.92 |
| 1.75 < M ≤ 2.0 | 3.82 |
| 2.0 < M ≤ 2.5 | 5.96 |
| 2.5 < M ≤ 3.0 | 8.59 |
| 3.0 < M ≤ 3.5 | 11.68 |
| 3.5 < M ≤ 4.0 | 15.26 |

(IEC 60335-2-40)

- Installation of this product must be done by experienced service technicians or professional installers only in accordance with this manual. Installation by non-professional or improper installation of the product might cause serious accidents such as injury, water leakage, electric shock, or fire. If the product is installed in disregard of the instructions in this manual, it will void the manufacturer's warranty.
- Do not turn on the power until all work has been completed. Turning on the power before the work is completed can cause serious accidents such as electric shock or fire.
- If refrigerant leaks when you are working, ventilate the area. If the leaking refrigerant is exposed to a direct flame, it may produce a toxic gas.
- Installation must be performed in accordance with regulations, codes, or standards for electrical wiring and equipment in each country, region, or the installation place.
- Do not use means to accelerate the defrosting process or to clean, other than those recommended by the manufacturer.
- This appliance is not intended for use by persons (including children) with reduced physical, sensory or mental capabilities, or lack of experience and knowledge, unless they have been given supervision or instruction concerning use of the appliance by a person responsible for their safety. Children should be supervised to ensure that they do not play with the appliance.
- To avoid danger of suffocation, keep the plastic bag or thin film used as the packaging material away from young children.
- The appliance shall be stored in a room without continuously operating ignition sources (for example: open flames, an operating gas appliance or an operating electric heater).
- Do not pierce or burn.
- Be aware that refrigerants may not contain an odour.

CAUTION

- Read carefully all safety information written in this manual before you install or use the air conditioner.
- Install the product by following local codes and regulations in force at the place of installation, and the instructions provided by the manufacturer.
- This product is part of a set constituting an air conditioner. The product must not be installed alone or be installed with a device not authorized by the manufacturer.
- Always use a separate power supply line protected by a circuit breaker operating on all wires with a distance between contact of 3 mm for this product.
- To protect the persons, earth (ground) the product correctly, and use the power cable combined with an Earth Leakage Circuit Breaker (ELCB).
- This product is not explosion proof, and therefore should not be installed in an explosive atmosphere.
- To avoid getting an electric shock, never touch the electrical components soon after the power supply has been turned off. After turning off the power, always wait 5 minutes or more before you touch the electrical components.
- This product contains no user-serviceable parts. Always consult experienced service technicians for repairing.
- When moving or relocating the air conditioner, consult experienced service technicians for disconnection and reinstallation of the product.
- Do not touch the aluminum fins of heat exchanger built-in the indoor or outdoor unit to avoid personal injury when you install or maintain the unit.
- Do not place any other electrical products or household belongings under the product. Condensation dripping from the product might get them wet, and may cause damage or malfunction to the property.

- Be careful not to scratch the air conditioner when handling it.

English

Deutsch

Français

Español

Italiano

Ελληνικά

Português

Русский

Türkçe

1.1. Precautions for using R32 refrigerant

The basic installation work procedures are the same as conventional refrigerant (R410A, R22) models.

However, pay careful attention to the following points:

Since the working pressure is 1.6 times higher than that of refrigerant R22 models, some of the piping and installation and service tools are special. (Refer to "2.1. Installation tools".)

Especially, when replacing a refrigerant R22 model with a new refrigerant R32 model, always replace the conventional piping and flare nuts with the R32 and R410A piping and flare nuts on the outdoor unit side.

For R32 and R410A, the same flare nut on the outdoor unit side and pipe can be used.

Models that use refrigerant R32 and R410A have a different charging port thread diameter to prevent erroneous charging with refrigerant R22 and for safety. Therefore, check beforehand. [The charging port thread diameter for R32 and R410A is 1/2-20 UNF.]

Be more careful than R22 so that foreign matter (oil, water, etc.) does not enter the piping. Also, when storing the piping, securely seal the opening by pinching, taping, etc. (Handling of R32 is similar to R410A.)

CAUTION

1-Installation (Space)

- That the installation of pipe-work shall be kept to a minimum.
- That pipe-work shall be protected from physical damage.
- The appliance shall not be installed in an unventilated space, if that space is smaller than X m²

| Amount of refrigerant charge M (kg) | Minimum room area X (m ²) |
|--|--|
| M ≤ 1.22 | - |
| 1.22 < M ≤ 1.23 | 1.45 |
| 1.23 < M ≤ 1.50 | 2.15 |
| 1.50 < M ≤ 1.75 | 2.92 |
| 1.75 < M ≤ 2.0 | 3.82 |
| 2.0 < M ≤ 2.5 | 5.96 |
| 2.5 < M ≤ 3.0 | 8.59 |
| 3.0 < M ≤ 3.5 | 11.68 |
| 3.5 < M ≤ 4.0 | 15.26 |

(IEC 60335-2-40)

- That compliance with national gas regulations shall be observed.
- That mechanical connections shall be accessible for maintenance purposes.
- In cases that require mechanical ventilation, ventilation openings shall be kept clear of obstruction.
- When disposing of the product is used, be based on national regulations, properly processed.

2-Serviceing

2-1 Service personnel

- Any person who is involved with working on or breaking into a refrigerant circuit should hold a current valid certificate from an industry-accredited assessment authority, which authorises their competence to handle refrigerants safely in accordance with an industry recognised assessment specification.
- Servicing shall only be performed as recommended by the equipment manufacturer. Maintenance and repair requiring the assistance of other skilled personnel shall be carried out under the supervision of the person competent in the use of flammable refrigerants.
- Servicing shall be performed only as recommended by the manufacturer.

2-2 Work

- Prior to beginning work on systems containing flammable refrigerants, safety checks are necessary to ensure that the risk of ignition is minimized. For repair to the refrigerating system, the precautions in 2-2 to 2-8 shall be complied with prior to conducting work on the system.
- Work shall be undertaken under a controlled procedure so as to minimize the risk of a flammable gas or vapour being present while the work is being performed.
- All maintenance staff and others working in the local area shall be instructed on the nature of work being carried out.
- Work in confined spaces shall be avoided.
- The area around the workspace shall be sectioned off.
- Ensure that the conditions within the area have been made safe by control of flammable material.

2-3 Checking for presence of refrigerant

- The area shall be checked with an appropriate refrigerant detector prior to and during work, to ensure the technician is aware of potentially flammable atmospheres.
- Ensure that the leak detection equipment being used is suitable for use with flammable refrigerants, i.e. nonsparking, adequately sealed or intrinsically safe.

CAUTION

2-4 Presence of fire extinguisher

- If any hot work is to be conducted on the refrigeration equipment or any associated parts, appropriate fire extinguishing equipment shall be available at hand.
- Have a dry powder or CO₂ fire extinguisher adjacent to the charging area.

2-5 No ignition sources

- No person carrying out work in relation to a refrigeration system which involves exposing any pipe work that contains or has contained flammable refrigerant shall use any sources of ignition in such a manner that it may lead to the risk of fire or explosion.
- All possible ignition sources, including cigarette smoking, should be kept sufficiently far away from the site of installation, repairing, removing and disposal, during which flammable refrigerant can possibly be released to the surrounding space.
- Prior to work taking place, the area around the equipment is to be surveyed to make sure that there are no flammable hazards or ignition risks. "No Smoking" signs shall be displayed.

2-6 Ventilated area

- Ensure that the area is in the open or that it is adequately ventilated before breaking into the system or conducting any hot work.
- A degree of ventilation shall continue during the period that the work is carried out.
- The ventilation should safely disperse any released refrigerant and preferably expel it externally into the atmosphere.

2-7 Checks to the refrigeration equipment

- Where electrical components are being changed, they shall be fit for the purpose and to the correct specification.
- At all times the manufacturer's maintenance and service guidelines shall be followed.
- If in doubt consult the manufacturer's technical department for assistance.
- The following checks shall be applied to installations using flammable refrigerants.
 - The charge size is in accordance with the room size within which the refrigerant containing parts are installed.
 - The ventilation machinery and outlets are operating adequately and are not obstructed.
 - If an indirect refrigerating circuit is being used, the secondary circuit shall be checked for the presence of refrigerant.
 - Marking to the equipment continues to be visible and legible. Markings and signs that are illegible shall be corrected.
 - Refrigeration pipe or components are installed in a position where they are unlikely to be exposed to any substance which may corrode refrigerant containing components, unless the components are constructed of materials which are inherently resistant to being corroded or are suitably protected against being so corroded.

2-8 Checks to electrical devices

- Repair and maintenance to electrical components shall include initial safety checks and component inspection procedures.
- If a fault exists that could compromise safety, then no electrical supply shall be connected to the circuit until it is satisfactorily dealt with.
- If the fault cannot be corrected immediately but it is necessary to continue operation, an adequate temporary solution shall be used.
- This shall be reported to the owner of the equipment so all parties are advised.
- Initial safety checks shall include.
 - That capacitors are discharged: this shall be done in a safe manner to avoid possibility of sparking.
 - That there no live electrical components and wiring are exposed while charging, recovering or purging the system.
 - That there is continuity of earth bonding.

3-Repairs to sealed components

- During repairs to sealed components, all electrical supplies shall be disconnected from the equipment being worked upon prior to any removal of sealed covers, etc.
- If it is absolutely necessary to have an electrical supply to equipment during servicing, then a permanently operating form of leak detection shall be located at the most critical point to warn of a potentially hazardous situation.
- Particular attention shall be paid to the following to ensure that by working on electrical components, the casing is not altered in such a way that the level of protection is affected.
 - This shall include damage to cables, excessive number of connections, terminals not made to original specification, damage to seals, incorrect fitting of glands, etc.
 - Ensure that apparatus is mounted securely.
 - Ensure that seals or sealing materials have not degraded such that they no longer serve the purpose of preventing the ingress of flammable atmospheres.
 - Replacement parts shall be in accordance with the manufacturer's specifications.

NOTES: The use of silicon sealant may inhibit the effectiveness of some types of leak detection equipment.
Intrinsically safe components do not have to be isolated prior to working on them.

 CAUTION

4-Repair to intrinsically safe components

- Do not apply any permanent inductive or capacitance loads to the circuit without ensuring that this will not exceed the permissible voltage and current permitted for the equipment in use.
- Intrinsically safe components are the only types that can be worked on while live in the presence of a flammable atmosphere.
- The test apparatus shall be at the correct rating.
- Replace components only with parts specified by the manufacturer.
- Other parts may result in the ignition of refrigerant in the atmosphere from a leak.

5-Cabling

- Check that cabling will not be subject to wear, corrosion, excessive pressure, vibration, sharp edges or any other adverse environmental effects.
- The check shall also take into account the effects of aging or continual vibration from sources such as compressors or fans.

6-Detection of flammable refrigerants

- Under no circumstances shall potential sources of ignition be used in the searching for or detection of refrigerant leaks.
- A halide torch (or any other detector using a naked flame) shall not be used.

7-Leak detection methods

- Electronic leak detectors shall be used to detect flammable refrigerants, but the sensitivity may not be adequate, or may need re-calibration. (Detection equipment shall be calibrated in a refrigerant-free area.)
- Ensure that the detector is not a potential source of ignition and is suitable for the refrigerant used.
- Leak detection equipment shall be set at a percentage of the LFL of the refrigerant and shall be calibrated to the refrigerant employed and the appropriate percentage of gas (25 % maximum) is confirmed.
- Leak detection fluids are suitable for use with most refrigerants but the use of detergents containing chlorine shall be avoided as the chlorine may react with the refrigerant and corrode the copper pipe-work.
- If a leak is suspected, all naked flames shall be removed/extinguished.
- If a leakage of refrigerant is found which requires brazing, all of the refrigerant shall be recovered from the system, or isolated (by means of shut off valves) in a part of the system remote from the leak. Oxygen free nitrogen (OFN) shall then be purged through the system both before and during the brazing process.

8-Removal and evacuation

- When breaking into the refrigerant circuit to make repairs – or for any other purpose –conventional procedures shall be used. However, it is important that best practice is followed since flammability is a consideration. The following procedure shall be adhered to:
 - remove refrigerant
 - purge the circuit with inert gas
 - evacuate
 - purge again with inert gas
 - open the circuit by cutting or brazing
- The refrigerant charge shall be recovered into the correct recovery cylinders.
- The system shall be “flushed” with OFN to render the unit safe.
- This process may need to be repeated several times.
- Compressed air or oxygen shall not be used for this task.
- Flushing shall be achieved by breaking the vacuum in the system with OFN and continuing to fill until the working pressure is achieved, then venting to atmosphere, and finally pulling down to a vacuum.
- This process shall be repeated until no refrigerant is within the system.
- When the final OFN charge is used, the system shall be vented down to atmospheric pressure to enable work to take place.
- This operation is absolutely vital if brazing operations on the pipe work are to take place.
- Ensure that the outlet for the vacuum pump is not close to any ignition sources and there is ventilation available.

9-Charging procedures

- In addition to conventional charging procedures, the following requirements shall be followed.
 - Ensure that contamination of different refrigerants does not occur when using charging equipment. Hoses or lines shall be as short as possible to minimize the amount of refrigerant contained in them.
 - Cylinders shall be kept upright.
 - Ensure that the refrigeration system is earthed prior to charging the system with refrigerant.
 - Label the system when charging is complete (if not already).
 - Extreme care shall be taken not to overfill the refrigeration system.
- Prior to recharging the system it shall be pressure tested with OFN.
- The system shall be leak tested on completion of charging but prior to commissioning.
- A follow up leak test shall be carried out prior to leaving the site.

 CAUTION

10-Decommissioning

- Before carrying out this procedure, it is essential that the technician is completely familiar with the equipment and all its details.
- It is recommended good practice that all refrigerants are recovered safely.
- Prior to the task being carried out, an oil and refrigerant sample shall be taken in case analysis is required prior to re-use of reclaimed refrigerant.
- It is essential that electrical power is available before the task is commenced.
 - a) Become familiar with the equipment and its operation.
 - b) Isolate system electrically.
 - c) Before attempting the procedure ensure that:
 - mechanical handling equipment is available, if required, for handling refrigerant cylinders;
 - all personal protective equipment is available and being used correctly;
 - the recovery process is supervised at all times by a competent person;
 - recovery equipment and cylinders conform to the appropriate standards.
 - d) Pump down refrigerant system, if possible.
 - e) If a vacuum is not possible, make a manifold so that refrigerant can be removed from various parts of the system.
 - f) Make sure that cylinder is situated on the scales before recovery takes place.
 - g) Start the recovery machine and operate in accordance with manufacturer's instructions.
 - h) Do not overfill cylinders. (No more than 80 % volume liquid charge).
 - i) Do not exceed the maximum working pressure of the cylinder, even temporarily.
 - j) When the cylinders have been filled correctly and the process completed, make sure that the cylinders and the equipment are removed from site promptly and all isolation valves on the equipment are closed off.
 - k) Recovered refrigerant shall not be charged into another refrigeration system unless it has been cleaned and checked.





11- Labelling

- Equipment shall be labelled stating that it has been de-commissioned and emptied of refrigerant.
- The label shall be dated and signed.
- Ensure that there are labels on the equipment stating the equipment contains flammable refrigerant.

12-Recovery

- When removing refrigerant from a system, either for servicing or decommissioning, it is recommended good practice that all refrigerants are removed safely.
- When transferring refrigerant into cylinders, ensure that only appropriate refrigerant recovery cylinders are employed.
- Ensure that the correct number of cylinders for holding the total system charge are available.
- All cylinders to be used are designated for the recovered refrigerant and labelled for that refrigerant (i.e. special cylinders for the recovery of refrigerant).
- Cylinders shall be complete with pressure relief valve and associated shut-off valves in good working order.
- Empty recovery cylinders are evacuated and, if possible, cooled before recovery occurs.
- The recovery equipment shall be in good working order with a set of instructions concerning the equipment that is at hand and shall be suitable for the recovery of flammable refrigerants.
- In addition, a set of calibrated weighing scales shall be available and in good working order.
- Hoses shall be complete with leak-free disconnect couplings and in good condition.
- Before using the recovery machine, check that it is in satisfactory working order, has been properly maintained and that any associated electrical components are sealed to prevent ignition in the event of a refrigerant release. Consult manufacturer if in doubt.
- The recovered refrigerant shall be returned to the refrigerant supplier in the correct recovery cylinder, and the relevant Waste Transfer Note arranged.
- Do not mix refrigerants in recovery units and especially not in cylinders.
- If compressors or compressor oils are to be removed, ensure that they have been evacuated to an acceptable level to make certain that flammable refrigerant does not remain within the lubricant.
- The evacuation process shall be carried out prior to returning the compressor to the suppliers.
- Only electric heating to the compressor body shall be employed to accelerate this process.
- When oil is drained from a system, it shall be carried out safely.

Explanation of symbols displayed on the indoor unit or outdoor unit.

| | | |
|--|----------------|---|
|  | WARNING | This symbol shows that this appliance uses a flammable refrigerant. If the refrigerant is leaked and exposed to an external ignition source, there is a risk of fire. |
|  | CAUTION | This symbol shows that the operation manual should be read carefully. |
|  | CAUTION | This symbol shows that a service personnel should be handling this equipment with reference to the installation manual. |
|  | CAUTION | This symbol shows that information is available such as the operating manual or installation manual. |

2. PRODUCT SPECIFICATION

2.1. Installation tools

| Tool name | Change from R22 to R32 (R410A) |
|-----------------------------|---|
| Gauge manifold | Pressure is high and cannot be measured with a R22 gauge. To prevent erroneous mixing of other refrigerants, the diameter of each port has been changed. It is recommended to use gauge with seals -0.1 to 5.3 MPa (-1 to 53 bar) for high pressure. -0.1 to 3.8 MPa (-1 to 38 bar) for low pressure. |
| Charge hose | To increase pressure resistance, the hose material and base size were changed. (R32/R410A) |
| Vacuum pump | A conventional vacuum pump can be used by installing a vacuum pump adapter. (Use of a vacuum pump with a series motor is prohibited.) |
| Gas leakage detector | Special gas leakage detector for HFC refrigerant R410A or R32. |

■ Copper pipes

It is necessary to use seamless copper pipes and it is desirable that the amount of residual oil is less than 40 mg/10 m. Do not use copper pipes having a collapsed, deformed or discolored portion (especially on the interior surface). Otherwise, the expansion valve or capillary tube may become blocked with contaminants.

As an air conditioner using R32 (R410A) incurs pressure higher than when using R22, it is necessary to choose adequate materials.

WARNING

- Do not use the existing (for R22) piping and flare nuts. If the existing materials are used, the pressure inside the refrigerant cycle will rise and cause failure, injury, etc. (Use the special R32/R410A materials.)
- Use (refill or replace with) specified refrigerant (R32) only. Use of unspecified refrigerant can cause product malfunction, burst, or injury.
- Do not mix any gas or impurities except specified refrigerant (R32). Inflow of air or application of unspecified material makes the internal pressure of the refrigerant cycle too high, and may cause product malfunction, burst of piping, or injury.
- For installation purposes, be sure to use the parts supplied by the manufacturer or other prescribed parts. The use of non-prescribed parts can cause serious accidents such as the unit falling, water leakage, electric shock, or fire.
- Do not turn on the power until all work has been completed.

CAUTION







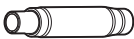

This manual describes how to install the indoor unit only. To install the outdoor unit or branch box, (if any), refer to the installation manual included in each product.

2.2. Accessories

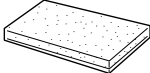

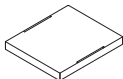
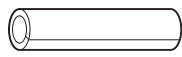

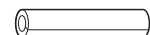

WARNING

For installation purposes, be sure to use the parts supplied by the manufacturer or other prescribed parts. The use of non-prescribed parts can cause serious accidents such as the unit to fall, water leakage, electric shock, or fire.

- Keep the Installation Manual in a safe place and do not discard any other accessories until the installation work has been completed.
- The following installation parts are furnished. Use them as required.

| Name and Shape | Q'ty | Name and Shape | Q'ty |
|---|------|---|------|
| Operating manual  | 1 | Drain hose [VP25(O.D.32, I.D.25)]  | 1 |
| Operating manual (CD-ROM)  | 1 | Drain hose insulation  | 1 |
| Installation manual (This manual)  | 1 | Hose band  | 1 |
| Template (carton top)  | 1 | Coupler heat insulation (large)  | 1 |
| Special nut A (large flange)  | 4 | Coupler heat insulation (small)  | 1 |
| Special nut B (small flange)  | 4 | Cable tie (for electrical wiring)  | 2 |

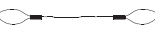
2.3. Cassette grille accessories

| Name and Shape | Q'ty | Description |
|--|------|---|
| Connector cover  | 1 | For covering connector |
| Tapping screw (M5 × 12 mm)  | 4 | For mounting cassette grille |
| Tapping screw (M4 × 12 mm)  | 1 | For mounting connector cover |
| L angle  | 2 | For mounting the hook wire to the cassette grille |
| Hook wire  | 2 | For suspending the cassette grille |
| Screw [pitch small] (M4 × 10 mm)  | 2 | For mounting the hook wire (for metals) |
| Screw [pitch large] (M4 × 10 mm)  | 4 | For mounting the L angle and hook wire (for resins) |

The following items are necessary to install this air conditioner. (The items are not included with the air conditioner and must be purchased separately.)

| Additional materials | |
|--------------------------------|----------------|
| Connection pipe assembly | Wall cap |
| Connection cable (4-conductor) | Saddle |
| Wall pipe | Drain hose |
| Decorative tape | Tapping screws |
| Vinyl tape | Putty |

2.4. Pipe requirement

| Model | Gas pipe size (thickness) [mm] | Liquid pipe size (thickness) [mm] |
|----------------|--------------------------------|-----------------------------------|
| 07, 09, 12, 14 | Ø 9.52 (0.80) | Ø 6.35 (0.80) |
| 18, 22, 24 | Ø 12.70 (0.80) | Ø 6.35 (0.80) |

CAUTION

Refer to the installation manual for the outdoor unit for description of allowable pipe length and height difference.

- Use pipe with water-resistant heat insulation.

CAUTION

- Wrap heat insulation around both gas pipe and liquid pipe. No heat-insulation work or incorrect heat-insulation work may cause water leaks.
- In a reverse cycle model, use heat insulation with heat resistance above 120 °C.
- If expected humidity of the installation location of refrigerant pipes is higher than 70 %, wrap the heat insulation around the refrigerant pipes. If the expected humidity is between 70 % and 80 %, use heat insulation that has a thickness of 15 mm or more. If the expected humidity is higher than 80 %, use heat insulation that has a thickness of 20 mm or more.
- The use of thinner heat insulation than specified above, may cause a condensation on the surface of the insulation.
- Use heat insulation with thermal conductivity of 0.045 W/(m·K) or less, at 20 °C.

2.5. Electrical requirement

The indoor unit is powered from the outdoor unit. Do not power indoor unit from separate power source.

WARNING

Standard for electrical wiring and equipment differs in each country or region. Before you start electrical working, confirm related regulations, codes, or standards.

| Cable | Conductor size [mm ²] | Type | Remarks |
|------------------|-----------------------------------|-------------------|-------------------------------------|
| Connection cable | 1.5 (Min) | Type 60245 IEC 57 | 3 cable + Earth (Ground), 1 Ø 230 V |

Cable Length: Limit voltage drop to less than 2%. Increase cable gauge if voltage drop is 2% or more.

2.6. Optional parts

Refer to each installation manual for the method of installing optional parts.

| | | |
|----------------------------------|--------------|---|
| Wired remote controller (*1) | UTY-RNR*Z* | For air conditioner operation (2-wired type) |
| | UTY-RLR* | |
| | UTY-RVN*M | For air conditioner operation (3-wired type) |
| | UTY-RNN*M | |
| Wireless remote controller | UTY-LNT* | For air conditioner operation |
| Fresh air intake kit | UTZ-VXAA | To take fresh air |
| Air outlet shutter plate | UTR-YDZB | Install the plate at outlet when carrying out 3-way direction operation |
| Insulation kit for High humidity | UTZ-KXGC | Install when the condition under the roof is over 80% in humidity and over 30°C in temperature. |
| External connect kit | PCB terminal | For control input port |
| | UTY-XWZXZG | For control output port |
| W-LAN interface | UTY-TFSXZ1 | For wireless LAN control |

*1: Wired remote controller is recommended using simultaneous twin or triple connection.

3. INSTALLATION WORK

WARNING

Do not move the appliance by holding the indoor unit pipes. (The stress applied to the pipe joints may cause the flammable gas to leak during operation.)

Especially, the installation place is very important for the split type air conditioner because it is very difficult to move from place to place after the first installation.

3.1. Selecting an installation location

WARNING

Select installation locations that can properly support the weight of the indoor unit. Install the units securely so that they do not topple or fall.

CAUTION

- Do not install the unit in the following areas:
 - Area with high salt content, such as at the seaside. It will deteriorate metal parts, causing the parts to fail or the unit to leak water.
 - Area filled with mineral oil or containing a large amount of splashed oil or steam, such as a kitchen. It will deteriorate plastic parts, causing the parts to fail or the unit to leak water.
 - Area where is close to heat sources.
 - Area that generates substances that adversely affect the equipment, such as sulfuric gas, chlorine gas, acid, or alkali. It will cause the copper pipes and brazed joints to corrode, which can cause refrigerant leakage.
 - Area that can cause combustible gas to leak, contains suspended carbon fibers or flammable dust, or volatile in flammables such as paint thinner or gasoline.
 - If gas leaks and settles around the unit, it can cause a fire.
 - Area where animals may urinate on the unit or ammonia may be generated.
- Do not use the unit for special purposes, such as storing food, raising animals, growing plants, or preserving precision devices or art objects. It can degrade the quality of the preserved or stored objects.
- Install the unit where drainage does not cause any trouble.
- Do not install where there is the danger of combustible gas leakage.
- Do not install the unit near a source of heat, steam, or flammable gas.
- Install the indoor unit, outdoor unit, power supply cable, transmission cable, and remote control cable at least 1 m away from a television or radio receivers. The purpose of this is to prevent TV reception interference or radio noise. (Even if they are installed more than 1 m apart, you could still receive noise under some signal conditions.)
- If children under 10 years old may approach the unit, take preventive measures so that they cannot reach the unit.
- Use the "Insulation kit for high humidity" (option), when the condition under the roof is over 80% in humidity and over 30°C in temperature. Otherwise, there is a risk of condensation on the ceiling.

Decide the mounting position together with the customer as follows:

- Install the indoor unit in a location having sufficient strength to support the weight of the indoor unit.
- The inlet and outlet ports should not be obstructed; the air should be able to blow all over the room.
- Leave the space required to service the air conditioner.
- Locate where the air can be distributed evenly throughout the room by the unit.
- Install the unit where connection to the outdoor unit is easy.
- Install the unit where the connection pipe can be easily installed.
- Install the unit where the drain pipe can be easily installed.
- Install the unit where noise and vibration is not amplified.
- Take servicing, etc., into consideration and leave the spaces. Also install the unit where the filter can be removed.

3.2. Installation dimensions

- The ceiling rear height as shown in the figure.

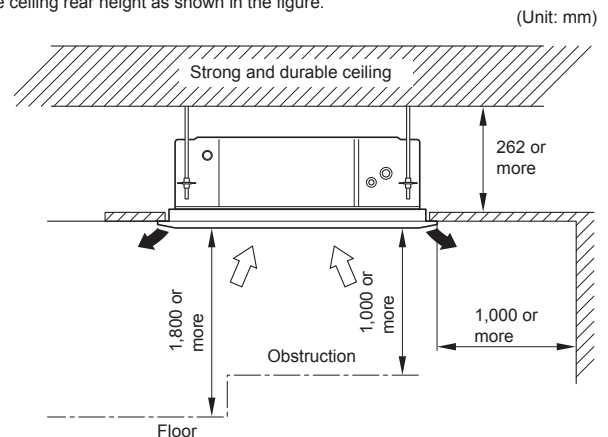

- This product can be installed at a height of up to 3,000mm. However, 7000, 9000 Btu/h model can not be installed in high places. Perform the Function Setting on the remote control in accordance with the installed height. (Refer to "7. FUNCTION SETTING")

■ Discharge direction setting

- The discharge direction can be selected as shown below.

(Unit: mm)

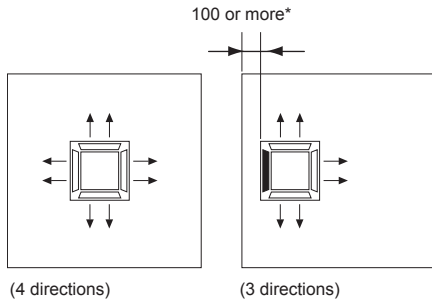

*Please ensure sufficient service access during installation.

- For a 3-way outlet, make sure to perform the Function Setting on the remote control. Also, make sure to use the optional shutter plate to block the outlet.
- The ceiling height cannot be set in the 3-way outlet mode. Therefore, do not change the setting in the setting the ceiling height. (Refer to "7. FUNCTION SETTING")
- When the outlet is shut, be sure to install the optional Air outlet shutter plate kit. For the details of installation, please refer to Installation Manual of kit.

3.3. Installing the unit

⚠ WARNING

- Install the air conditioner in a location which can withstand a load of at least 5 times the weight of the main unit and which will not amplify sound or vibration. If the installation location is not strong enough, the indoor unit may fall and cause injuries.
- If the job is done with the panel frame only, there is a risk that the unit will come loose. Please take care.

3.3.1. Position the ceiling hole and hanging bolts

Ceiling openings and hanging bolt installation diagram.

⚠ WARNING

When fastening the hangers, make the bolt positions uniform.

(Unit: mm)

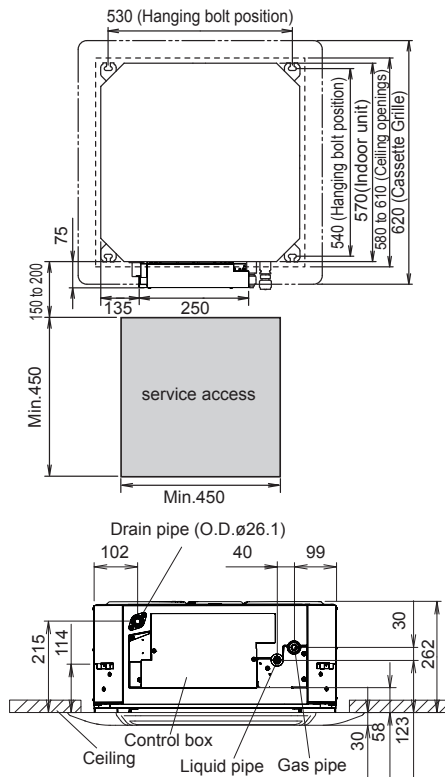

Be sure to keep sufficient space in the designated position for future maintenance.

3.3.2. Body installation

- Install special nut A, then special nut B onto the hanging bolt.
- Raise the body and mount its hooks onto the hanging bolt between the special nuts.
- Turn special nut B to adjust the height of the body.

⚠ WARNING

- Perform final tightening by tightening the double nut firmly.
- Be sure to install the body horizontally and adjust the height below the body and the ceiling surface properly.

(Unit: mm)

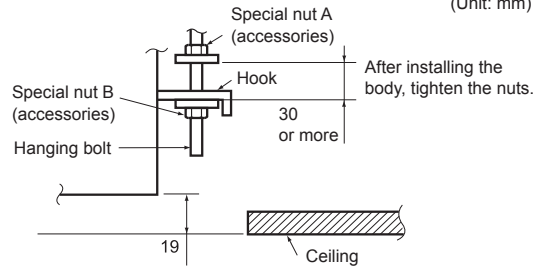

3.3.3. Leveling

Using a level, or vinyl hose filled with water, fine adjust so that the body is level. Inclined installation so as the drain pipe side is higher may cause a malfunction of the float switch, and may cause water leakage.

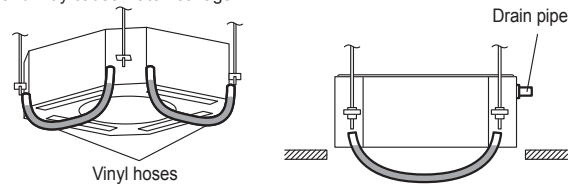

3.4. Drain installation

⚠ WARNING

- Do not insert the drain piping into the sewer where sulfurous gas occurs. (Heat exchange erosion may occur)
- Insulate the parts properly so that water will not drip from the connection parts.
- Check for proper drainage after installation by using the visible portion of transparent drain port and the drain piping final outlet on the body.

⚠ CAUTION

Do not apply adhesive agent on the drain port of the body. (Use the attached drain hose assembly to connect the drain piping)

3.4.1. Installing the drain pipe

■ When not lifting up drain pipe:

- Install the drain pipe with downward gradient (1/50 to 1/100) and so there are no rises or traps in the pipe.
- Use general hard polyvinyl chloride pipe (VP25) [outside diameter 32mm] and connect it with adhesive (polyvinyl chloride) so that there is no leakage.
- When the pipe is long, install supporters.
- Do not perform air bleeding.
- Always heat insulate indoor section of drain pipe.
- If it is impossible to have sufficient gradient of pipe, perform drain lift-up.

| Pipe size | |
|------------|-------------------|
| Drain pipe | VP25 (O.D. 32 mm) |

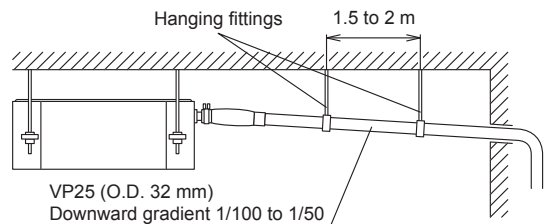

PROHIBITED:

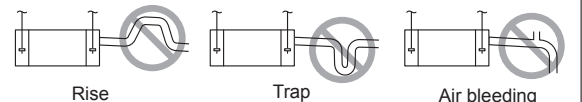

■ **When lifting up drain pipe:**

- Height of inclined pipe should be less than 700 mm from the ceiling. A rise dimension over this range will cause leakage.
- Lift up the pipe vertically at the position of 300 mm or less from the unit.

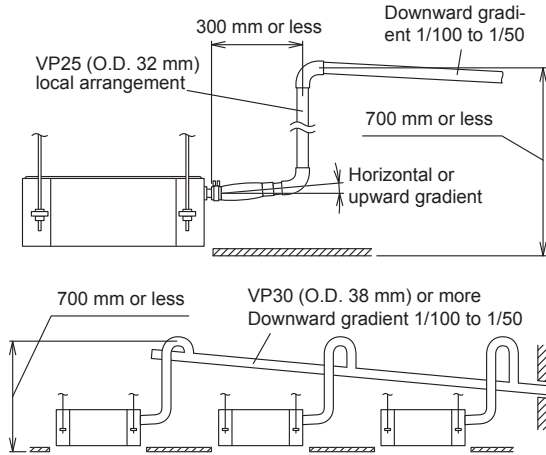

3.4.2. Installation procedure

- 1) Install the attached drain hose to the drain port of the body. Install the hose band from the top of the hose within the shown in the figure area.
- 2) Use vinyl adhesive agent to glue the drain piping (PVC pipe VP25) to the drain hose assembly.
(Apply color adhesive agent evenly until the gauge line and seal)
- 3) Check the drainage. (Refer to separate diagram)
- 4) Install the heat insulation.
- 5) Use the attached heat insulation to insulate the drain port and hose band.

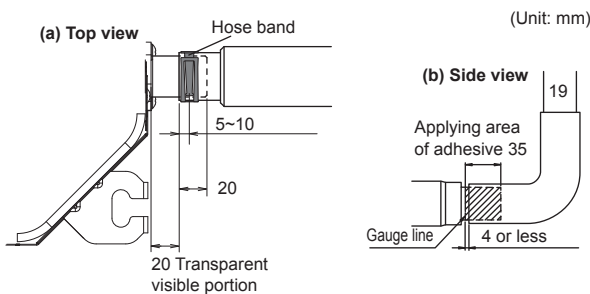
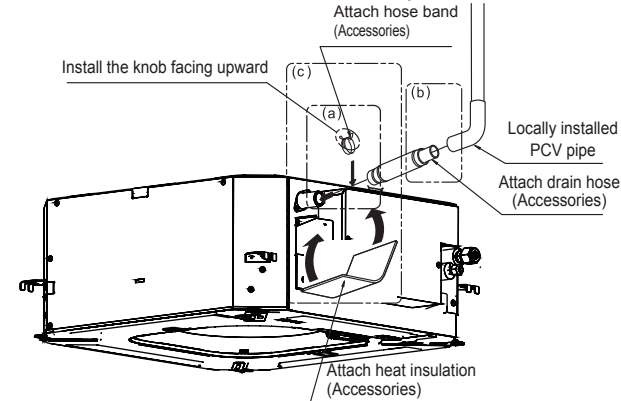

(c) Hose opening view

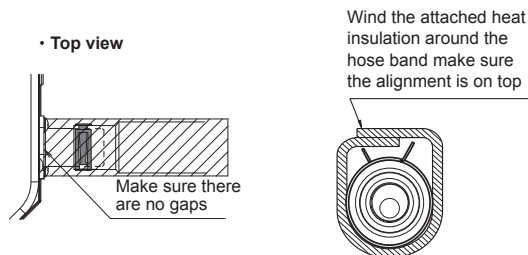

NOTES:

Check for drainage

Pour about 1 liter of water from the position shown in the diagram or from the airflow outlet to the dew tray. Check for any abnormalities such as strange noises and whether the drain pump functions normally. The drain pump operates when operating in the cooling mode.

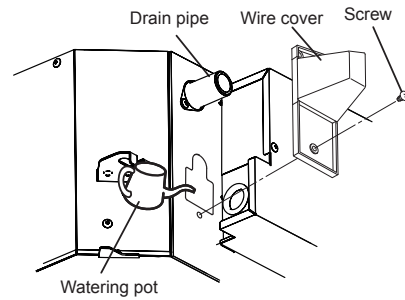

3.5. Pipe installation

CAUTION

- Tighten the flare nuts with a torque wrench using the specified tightening method. Otherwise, the flare nuts could break after a prolonged period, causing refrigerant to leak and generate hazardous gas if the refrigerant comes into contact with a flame.
- Be careful that foreign matter (oil, water, etc.) does not enter the piping with refrigerant R32(R410A) models. Also, when storing the piping, securely seal the openings by pinching, taping, etc.
- While brazing the pipes, be sure to purge with dry nitrogen gas.

3.5.1. Pipe connection

■ **Flaring**

Use special pipe cutter and flare tool designed for R410A or R32 pipework.

- (1) Cut the connection pipe to the necessary length with a pipe cutter.
- (2) Hold the pipe downward so that cuttings will not enter the pipe and remove any burrs.
- (3) Insert the flare nut (always use the flare nut attached to the indoor unit(s) and outdoor unit or branch box respectively) onto the pipe and perform the flare processing with a flare tool. Use the special R410A or R32 flare tool, or the conventional flare tool. Leakage of refrigerant may result if other flare nuts are used.
- (4) Protect the pipes by pinching them or with tape to prevent dust, dirt, or water from entering the pipes.

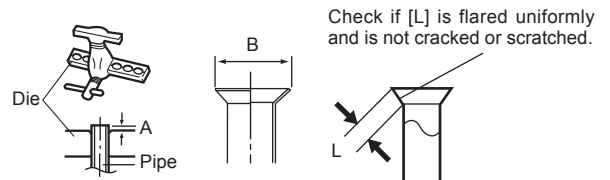

| Pipe outside diameter [mm (in.)] | Dimension A [mm] | Dimension B [mm] |
|----------------------------------|---------------------------------|------------------|
| | Flare tool for R32, clutch type | |
| 6.35 (1/4) | 0 to 0.5 | 9.1 |
| 9.52 (3/8) | | 13.2 |
| 12.70 (1/2) | | 16.6 |
| 15.88 (5/8) | | 19.7 |
| 19.05 (3/4) | | 24.0 |

When using conventional flare tools to flare R32 pipes, the dimension A should be approximately 0.5 mm more than indicated in the table (for flaring with R32 flare tools) to achieve the specified flaring. Use a thickness gauge to measure the dimension A.

Width across flats

| Pipe outside diameter [mm (in.)] | Width across flats of Flare nut [mm] |
|----------------------------------|--------------------------------------|
| 6.35 (1/4) | 17 |
| 9.52 (3/8) | 22 |
| 12.70 (1/2) | 26 |
| 15.88 (5/8) | 29 |
| 19.05 (3/4) | 36 |

NOTES: The flare nut specification is compliant with ISO14903.

■ Bending pipes

⚠ CAUTION

- To prevent breaking of the pipe, avoid sharp bends.
- If the pipe is bent repeatedly at the same place, it will break.

- The pipes are shaped by your hands. Be careful not to collapse them.
- Bend R70 mm or more with a pipe bender.
- Do not bend the pipes in an angle more than 90°.
- When pipes are repeatedly bent or stretched, the material will harden, making it difficult to bend or stretch them anymore.
- Do not bend or stretch the pipes more than 3 times.
- When bending the pipe, do not bend it as is. The pipe will be collapsed. In this case, cut the insulating pipe with a sharp cutter as shown on the right, and bend it after exposing the pipe. After bending the pipe as you want, be sure to put the heat insulating pipe back on the pipe, and secure it with tape.

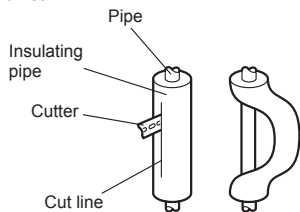

■ Flare connection

⚠ CAUTION

- Be sure to install the pipe against the port on the indoor unit correctly. If the centering is improper, the flare nut cannot be tightened smoothly. If the flare nut is forced to turn, the threads will be damaged.
- Do not remove the flare nut from the indoor unit pipe until immediately before connecting the connection pipe.
- Hold the torque wrench at its grip, keeping it in the right angle with the pipe, in order to tighten the flare nut correctly.
- Tighten the flare nuts with a torque wrench using the specified tightening method. Otherwise, the flare nuts could break after a prolonged period, causing refrigerant to leak and generate hazardous gas if the refrigerant comes into contact with a flame.
- Connect the piping so that the control box cover can easily be removed for servicing when necessary.
- In order to prevent water from leaking into the control box, make sure that the piping is well insulated.

- (1) Detach the caps and plugs from the pipes.
- (2) Center the pipe against the port on the indoor unit, and then turn the flare nut by hand.

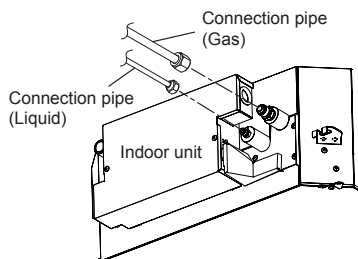

- (3) When the flare nut is tightened properly by your hand, hold the body side coupling with a wrench, then tighten with a torque wrench. (Refer to the following table for the flare nut tightening torques.)

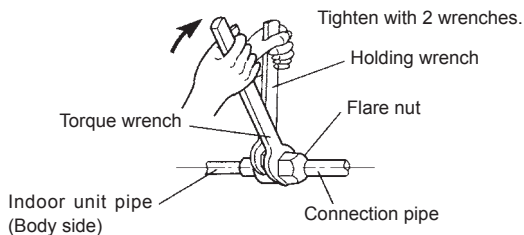

| Flare nut [mm (in.)] | Tightening torque [N·m (kgf·cm)] |
|----------------------|----------------------------------|
| 6.35 (1/4) dia. | 16 to 18 (160 to 180) |
| 9.52 (3/8) dia. | 32 to 42 (320 to 420) |
| 12.70 (1/2) dia. | 49 to 61 (490 to 610) |
| 15.88 (5/8) dia. | 63 to 75 (630 to 750) |
| 19.05 (3/4) dia. | 90 to 110 (900 to 1,100) |

Do not remove the cap from the connection pipe before connecting the pipe.

3.6. Electrical wiring

⚠ WARNING

- Electrical work must be performed in accordance with this Manual by a person certified under the national or regional regulations. Be sure to use a dedicated circuit for the unit. An insufficient power supply circuit or improperly performed electrical work can cause serious accidents such as electric shock or fire.
- Before starting work, check that power is not being supplied to the indoor unit and outdoor unit.
- For wiring, use the prescribed type of cables, connect them securely, making sure that there are no external forces of the cables applied to the terminal connections. Improperly connected or secured cables can cause serious accidents such as overheating the terminals, electric shock, or fire.
- Securely install the electrical box cover on the unit. An improperly installed electrical box cover can cause serious accidents such as electric shock or fire through exposure to dust or water.
- Install sleeves into any holes made in the walls for wiring. Otherwise, a short circuit could result.
- Use the included connection cables and power cables or ones specified by the manufacturer. Improper connections, insufficient insulation, or exceeding the allowable current can cause electric shock or fire.
- Do not modify the power cables, use extension cables, or use any branches in the wiring. Improper connections, insufficient insulation, or exceeding the allowable current can cause electric shock or fire.
- Match the terminal block numbers and connection cable colors with those of the outdoor unit or branch box. Erroneous wiring may cause burning of the electric parts.
- Securely connect the connection cables to the terminal board. In addition, secure the cables with wiring holders. Improper connections, either in the wiring or at the ends of the wiring, can cause a malfunction, electric shock, or fire.
- Always fasten the outside covering of the connection cable with the cable clamp. (If the insulator is chafed, electric leakage may occur.)
- Install an earth leakage breaker. In addition, install the earth leakage breaker so that the entire AC main power supply is cut off at the same time. Otherwise, electric shock or fire could result.
- Always connect the earth (ground) cable. Improper earthing (grounding) work can cause electric shocks.
- Perform wiring work in accordance with standards so that the air conditioner can be operated safely and positively.
- Connect the connection cable firmly to the terminal board. Imperfect installation may cause a fire.
- Use ring terminals and tighten the terminal screws to the specified torques, otherwise, abnormal overheating may be produced and possibly cause heavy damage inside the unit.

⚠ CAUTION

- Be careful not to generate a spark as follows for using a flammable refrigerant.
 - Do not remove the fuse while the power is on.
 - Do not disconnect the wiring while the power is on.
 - It is recommended to position the outlet connection in a high position. Place the cords so that they do not get tangled.
- Earth (Ground) the unit. Do not connect the earth (ground) cable to a gas pipe, water pipe, lightning rod, or a telephone earth (ground) cable. Improper earthing (grounding) may cause electric shock.
- Install the remote controller cables so as not to be direct touched with your hand.
- Do not connect power supply cables to the transmission or remote controller terminals, as this will damage the product.
- Never bundle the power supply cable and transmission cable, remote controller cable together. Separate these cable by 50 mm or more. Bundling these cables together will cause miss operation or breakdown.
- When handling PCB, static electricity charged in the body may cause malfunction of the PCB. Follow the cautions below:
 - Establish an earth (a ground) for the indoor and outdoor units and peripheral devices.
 - Cut power (breaker) off.
 - Touch metal part of the indoor and outdoor units for more than 10 seconds to discharge static electricity charged in the body.
 - Do not touch terminals of parts and patterns implemented on PCB.
- Be sure to refer to the below diagram for do correct field wiring. Wrong wiring causes malfunction of the unit.
- Check local electrical rules and also any specific wiring instructions or limitation.

3.6.1. Wiring system diagram

■ Standard pair

Connection cable

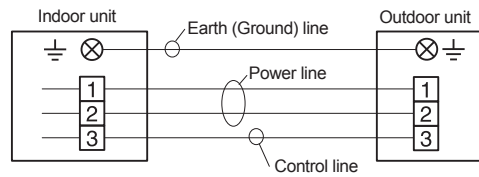

Wired remote controller cable

2-wire type

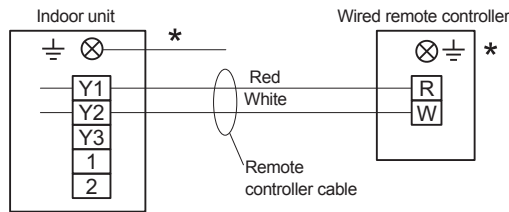

3-wire type

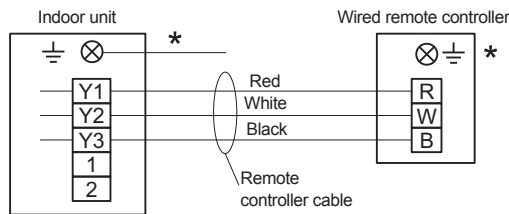

*Earth (Ground) the remote controller if it has a earth (ground) line.

■ Flexible multi

Connection cable

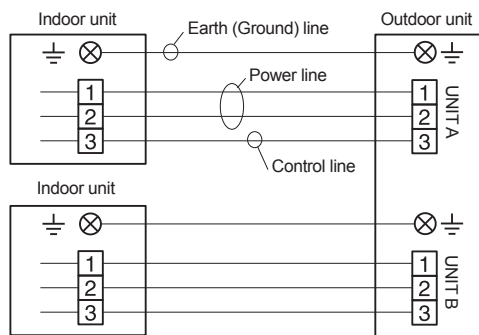

Wired remote controller cable

2-wire type

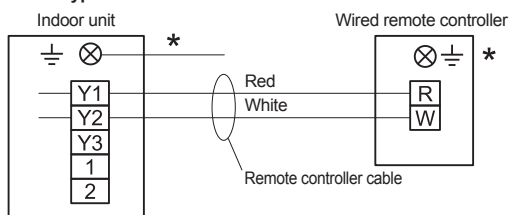

3-wire type

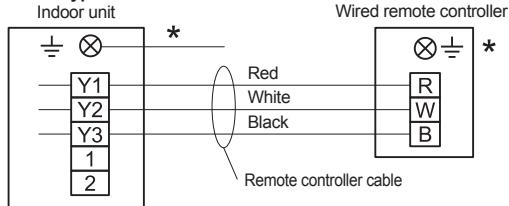

*Earth (Ground) the remote controller if it has a earth ground) line.

■ Simultaneous twin (18 model only)

Connection cable

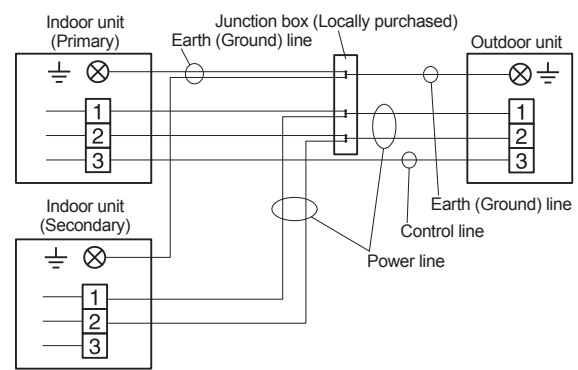

Wired remote controller cable

3-wire type only

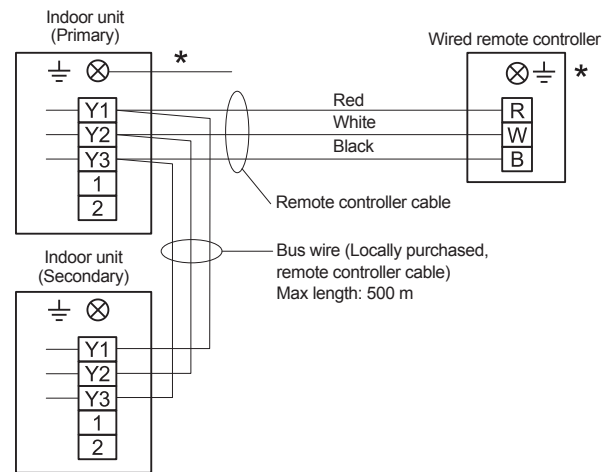

*Earth (Ground) the remote controller if it has a earth (ground) line.

• Connect the remote controller wires to the primary unit.

■ Simultaneous triple (18 model only)

Connection cable

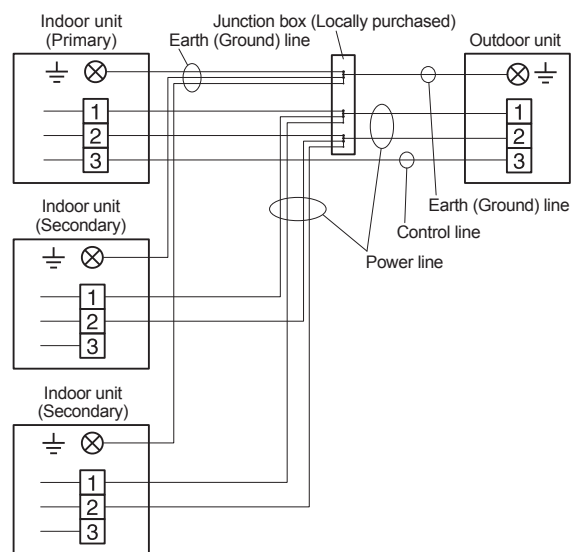

Wired remote controller cable

3-wire type only

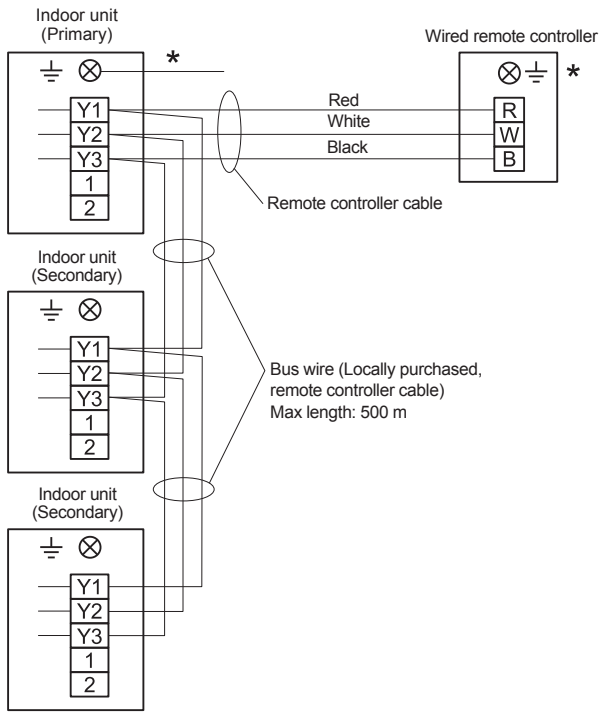

- *Earth (Ground) the remote controller if it has a earth (ground) line.
 - * Connect the remote controller wires to the primary unit.
- Wired remote controller is recommended using simultaneous twin or triple connection.

3.6.2. Connection cable preparation

■ Connection cable

Keep the earth (ground) wire longer than the other wires.

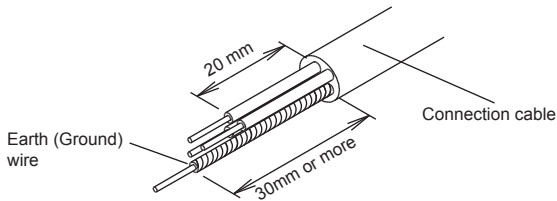

- Use a 4-core wire cable.

■ Remote controller cable

For 2-wire type

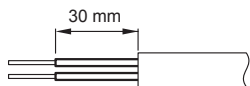

For 3-wire type

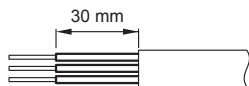

3.6.3. How to connect wiring to the terminals

■ Caution when wiring cable

To strip off the insulation of a lead wire, always use a special tool such as a wire stripper. If there is no special tool, carefully strip off the insulation by using a knife or other utensil.

- (1) Use ring terminals with insulating sleeves as shown in the figure to connect to the terminal block.
- (2) Securely clamp the ring terminals to the wires by using an appropriate tool so that the wires do not come loose.

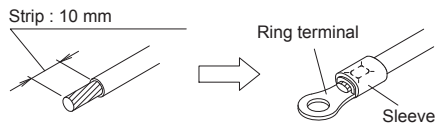

- (3) Connect specified wires securely, and fasten them so that there is no stress applied on the terminals.
- (4) Use a screwdriver with an appropriate bit size to tighten the terminal screws. Using of screwdriver with inappropriate bit size will damage the screw heads, and the screws will not be tightened properly.
- (5) Do not overtighten the terminal screws. Otherwise, the screws may break.

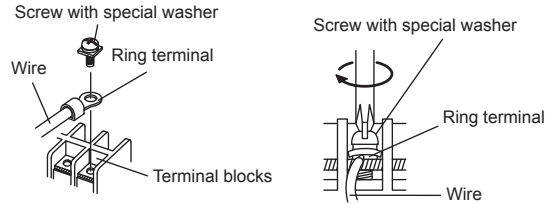

- (6) Refer to the table for the terminal screw tightening torques.
- (7) Please do not fix 2 power supply cables with 1 screw.

| Tightening torque [N·m (kgf·cm)] | |
|----------------------------------|-----------------------|
| M4 screw | 1.2 to 1.8 (12 to 18) |

3.6.4. Connection wiring

⚠ CAUTION

- Be careful not to mistake the power supply cable and connection wires when installing.
- Install so that the wires for the remote controller will not come in contact with other connection wires.

- (1) Remove the control box cover
- (2) Connect the connection cable.

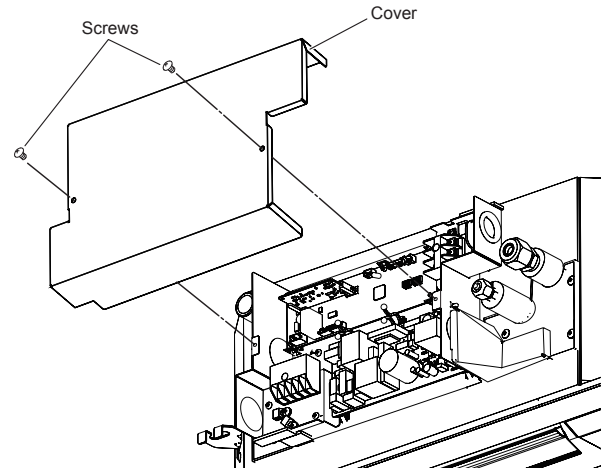

■ Connection cable

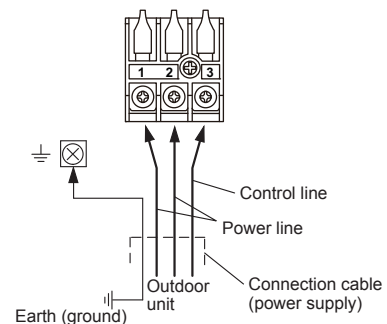

Remote controller cable

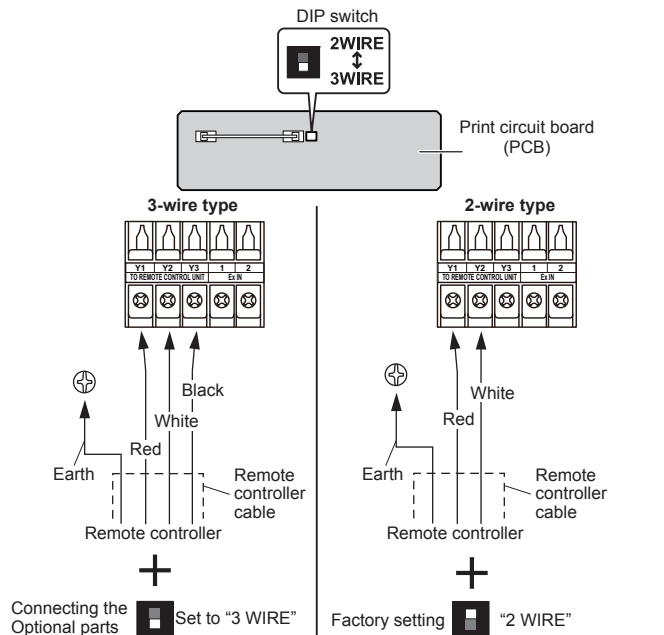

*Earth (Ground) the remote controller if it has a earth (ground) wire.

NOTES: Be sure to change the DIP SW to the corresponding remote controller.

When a 2-wire remote controller is connected to a "3WIRE" setting, power will not be supplied.

When a 3-wire remote controller is connected to a "2WIRE" setting, a communication error will be detected.

- After wiring is complete, secure the remote controller cable, connection cable with the cable clamps.

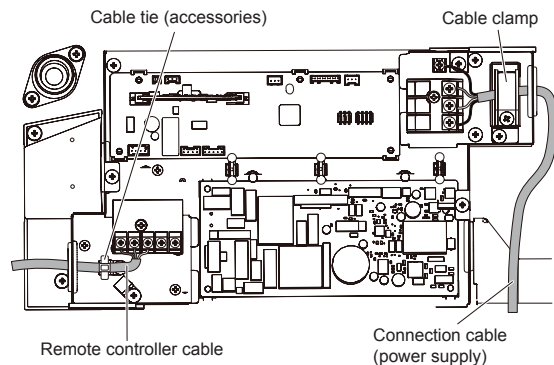

Do not bind the connection cable (power supply) and other cables together.

- Seal the cable outlet or other gaps with putty to prevent dew condensation or insect from entering the electric control box.
- Replace the control box cover.

CAUTION

Do not bundle the remote controller cable, or wire the remote controller cable in parallel, with the indoor unit connection wire (to the outdoor unit) and the power supply cable. It may cause erroneous operation.

3.7. Remote controller setting

To install and set the remote controller, refer to the installation manual of the remote controller.

4. CASSETTE GRILLE INSTALLATION

- Installation according to the Installation instruction sheet Cassette grille.
- Be sure to confirm there is no gap between the panel and main unit after installing the Cassette grille.

4.1. Remove the intake grille

- Slide the 2 grille hooks.

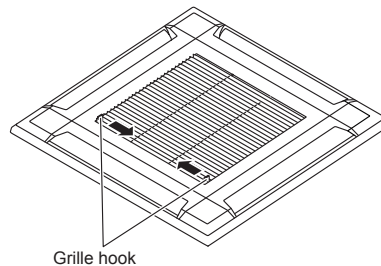

- Open the intake grille and remove.

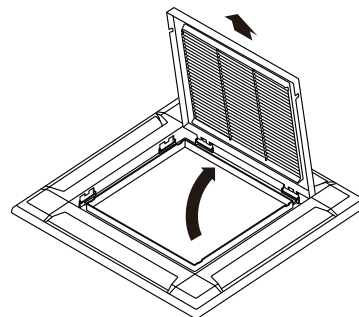

4.2. Installing the panel to indoor unit

- Install the cassette grille on the indoor unit.

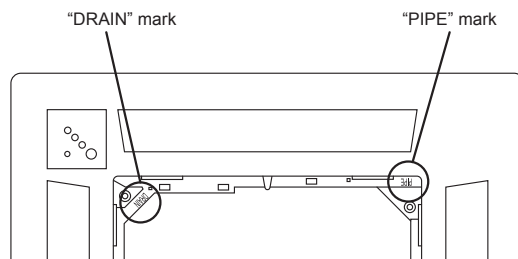

- Align the stamped marks on the cassette grille to the pipe and the drain of the indoor unit.

CAUTION

Use only the supplied screws to install the cassette grille.

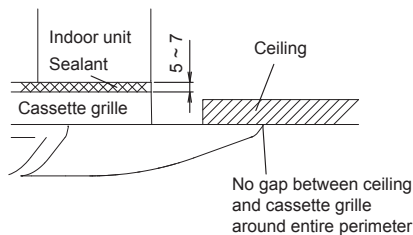

(2) Connect the connector.

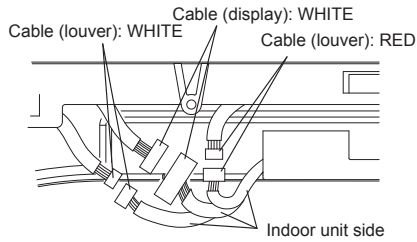

• Arrange the cables as illustrated below.

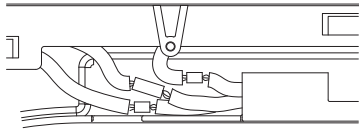

(3) Attach the connector cover.

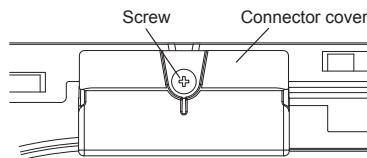

4.3. Attach the intake grille

The installation is the reverse of "REMOVING THE INTAKE GRILLE". The intake grille can be rotated and installed 4 ways to suit the user's preference.

CAUTION

- The louver angle cannot be changed if the power is not on. (If moved by hand, it may be damaged.)
- The grille assembly is directionally relative to the air conditioner body.
- Install so that there is no gap between the grille assembly and the air conditioner body.
- The cassette grille equips with an accessory to prevent the grill completely open. Be sure to read the INSTALLATION SHEET included with the cassette grille before installation.

5. OPTIONAL INSTALLATION WORK

5.1. Optional kit installation

WARNING

Regulation of cable differs from each locality, refer in accordance with local rules.

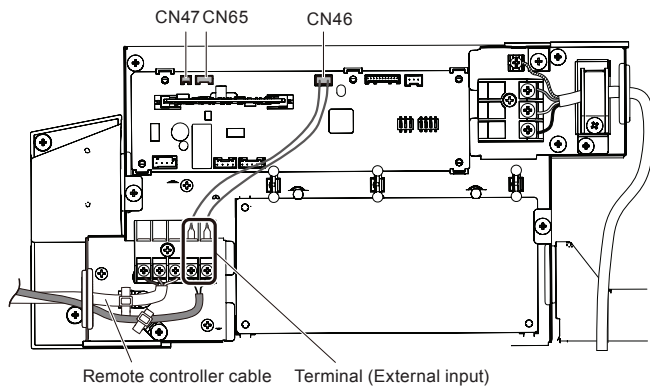

This air conditioner can be connected with the following optional kits. For details on how to install optional parts, refer to the installation manual included in each item.

| Connector No. | Option type |
|---------------|---|
| — | Wired remote controller |
| CN46 | External input (PCB Terminal) |
| CN47 | Fresh air intake kit (UTZ-VXAA) External output (UTY-XWZXZG) [*1] |
| CN65 [*2] | Other optional parts |

*1: For external output terminal setting, refer to Function No.60 in "7. FUNCTION SETTING".

*2: Other options (WLAN adapter, converters, etc.) may be connectable. Please refer to the technical data for details.

NOTES: Options connecting to CN47 or CN65 cannot be used at the same time.

5.2. External input and output

5.2.1. External input

- Indoor unit functions such as Operation/Stop or Forced stop can be done by using indoor unit terminals.
- "Operation/Stop" mode or "Forced stop" mode can be selected with function setting of indoor unit.
- A twisted pair cable (22 AWG) should be used. Maximum length of cable is 150 m (492 ft.).
- Use an external input and output cable with appropriate external dimension, depending on the number of cables to be installed.
- The wire connection should be separate from the power cable line.

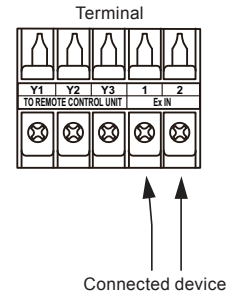

• Dry contact terminal

When a power supply is unnecessary at the input device you want to connect, use the Dry contact terminal.

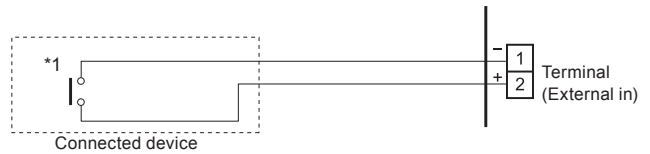

*1: The switch can be used on the following condition: DC 12 V to 24 V, 1 mA to 15 mA.

■ Operation behavior

• Input signal type



When function setting is "Operation/Stop" mode 1.

| Input signal | Command |
|--------------|-----------|
| OFF → ON | Operation |
| ON → OFF | Stop |

When function setting is "Forced stop" mode.

| Input signal | Command |
|--------------|-------------|
| OFF → ON | Forced stop |
| ON → OFF | Normal |

* When the forced stop is triggered, indoor unit stops and Operation/Stop operation by a remote controller is restricted.

When function setting is "Operation/Stop" mode 2.

| Input signal | Command |
|--------------|----------------------|
| OFF → ON | Operation |
| ON → OFF | Stop (R.C. disabled) |

5.2.2. External output

- A twisted pair cable (22AWG) should be used. Maximum length of cable is 25 m (82 ft.).
- Use an external input and output cable with appropriate external dimension, depending on the number of cables to be installed.
- Output voltage: Hi DC12V±2V, Lo 0V.
- Permissible current: 50mA

■ Output select

When interlocking with external device

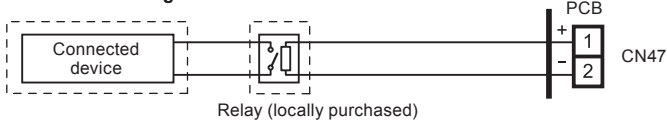

or

When displaying "Operation/Stop"

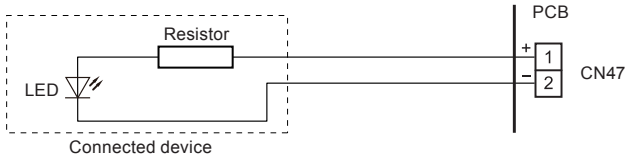

■ Operation behavior

*If function setting "60" is set to "00"

| Function setting | Status | Output voltage | |
|------------------|---------------------|---------------------------|---------|
| 60 | 00 | Stop | 0V |
| | | Operation | DC 12 V |
| | 09 | Normal | 0V |
| | | Error | DC 12 V |
| | 10 | Indoor unit fan stop | 0V |
| | | Indoor unit fan operation | DC 12 V |
| 11 | External heater OFF | 0 V | |
| | External heater ON | DC 12V | |

5.2.3. Connection methods

■ Wire modification

- Remove insulation from wire attached to wire kit connector.
- Remove insulation from locally purchased cable. Use crimp type insulated butt connector to join field cable and wire kit wire.
- Connect the wire with connecting wire with solder.

IMPORTANT: Be sure to insulate the connection between the wires.

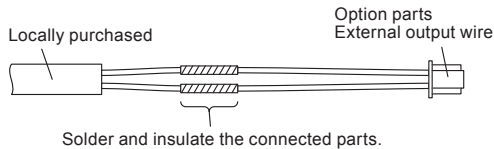

- Connecting wires to the terminals.
Use ring terminals with insulating sleeves to connect to the terminal block.
- Connection terminals and wiring arrangement (Refer to "5.4. Other optional parts")

5.3. Remote sensor (Optional parts)

5.3.1. Connection method

- Remove the existing connector and replace it with the remote sensor connector (ensure that the correct connector is used).
- The original connector should be insulated to ensure that it does not come into contact with other electrical circuitry.
- Connection terminals and wiring arrangement. (Refer to "5.4. Other optional parts")

5.3.2. Setting for room temperature correction

When a remote sensor is connected, set the function setting of indoor unit as indicated below.

- Function Number "30":
Set the Setting Number to "00". (Default)
- Function Number "31":
Set the Setting Number to "02".

* Refer to "7. FUNCTION SETTING" for details about Function number and Setting value

5.4. Other optional parts

5.4.1. Connection method

- Connection terminals and wiring arrangement

In following figure, all the possible connections are done for description.
In actual installation, connections will differ according to each installation requirements.

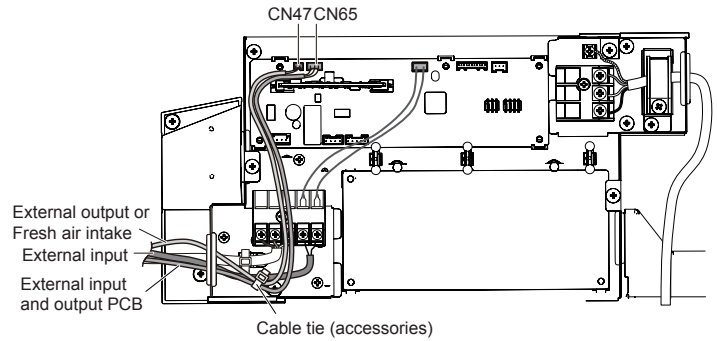

5.5. Optional parts cable binding

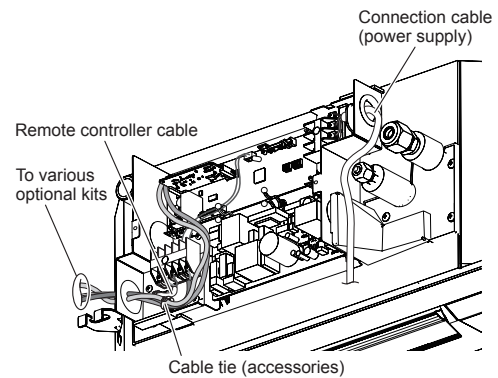

- Do not bind the connection cable (power supply) and other cables together.

⚠ CAUTION

To protect the cable insulation after opening a knockout hole, remove any burrs from the edge of the hole.

6. REMOTE CONTROL INSTALLATION

6.1. Group control

NOTES: Group control cannot be used together with W-LAN adapter.

CAUTION

Group control cannot be used when using it by the flexible multi type.

A number of indoor units can be operated at the same time using a single remote controller.
*When different types of indoor units (such as wall mounted type and cassette type, cassette type and duct type, or other combinations) are connected using group control system, some functions may no longer be available.

(1) Connect up to 16 indoor units in a system. (indoor unit to remote controller)

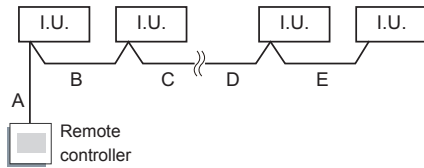

A, B, C, D, E : Remote controller cable.
A+B+C+D+E ≤ 500 m.

Example of wiring method (2-wire type)

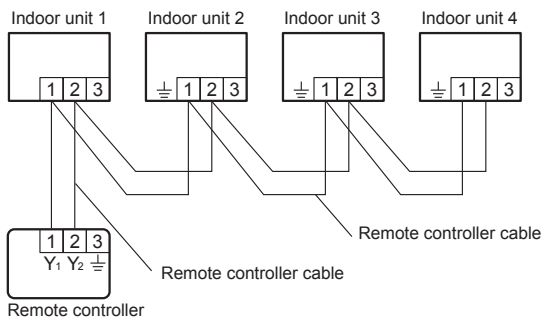

(2) Set the R.C. address (DIP switch setting)

Set the R.C. address of each indoor unit using the DIP switch on the indoor unit circuit board.

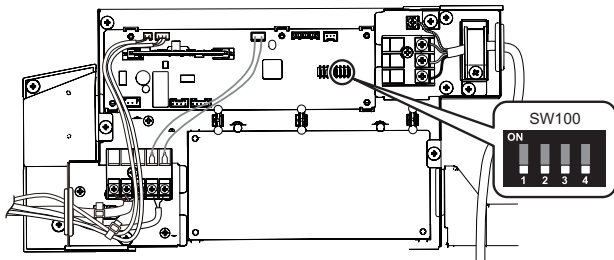

(a) 2-wire type

DIP switch (RC AD SW)...Factory setting "00"

Since the remote controller address settings are automatically configured, you do not need to configure them.

If configuring manually, it is necessary to configure both the indoor unit and the remote controller. For details, please refer to the remote controller installation manual.

(b) 3-wire type

DIP switch (RC AD SW)...Factory setting "00"

When connecting multiple indoor units to 1 standard wired remote controller, set the address at RC AD SW in sequence from "00".

| Setting | Setting range | Switch 100 | |
|---------------------------|---------------|--------------------|-------|
| Remote controller address | 00 to 15 | Setting example 00 | |
| | | | RC AD |

Example

If 4 indoor units are connected.

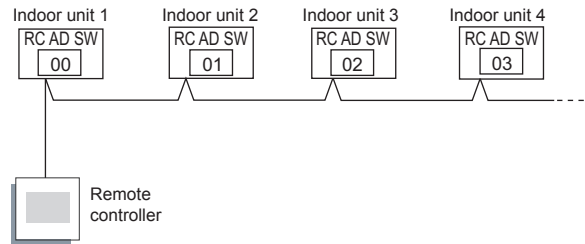

Set the R.C. address in accordance with the table below.

| Indoor unit | R.C. address | DIP SWITCH No. | | | |
|-------------|--------------|----------------|-----|-----|-----|
| | | 1 | 2 | 3 | 4 |
| 1 | 00 | OFF | OFF | OFF | OFF |
| 2 | 01 | ON | OFF | OFF | OFF |
| 3 | 02 | OFF | ON | OFF | OFF |
| 4 | 03 | ON | ON | OFF | OFF |
| 5 | 04 | OFF | OFF | ON | OFF |
| 6 | 05 | ON | OFF | ON | OFF |
| 7 | 06 | OFF | ON | ON | OFF |
| 8 | 07 | ON | ON | ON | OFF |
| 9 | 08 | OFF | OFF | OFF | ON |
| 10 | 09 | ON | OFF | OFF | ON |
| 11 | 10 | OFF | ON | OFF | ON |
| 12 | 11 | ON | ON | OFF | ON |
| 13 | 12 | OFF | OFF | ON | ON |
| 14 | 13 | ON | OFF | ON | ON |
| 15 | 14 | OFF | ON | ON | ON |
| 16 | 15 | ON | ON | ON | ON |

NOTES:

Be sure to set consecutive R.C. address.

The indoor units cannot be operated if a number is skipped.

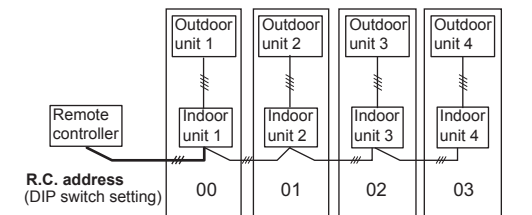

--- : Transmission cable, Power supply cable

--- : Remote controller cable --- : Connection cable

■ Settings when simultaneous Multi is included

(3) Remote controller setting

1. Turn on all of the indoor units.

* Turn on the indoor unit with the R.C. address "00" last.
(Within 1 minute)

2. Set the refrigerant circuit address.

Assign the same number to all of the indoor units connected to an outdoor unit.
(The unit is factory-set to "00")

| Function number | Setting value | Setting description |
|-----------------|---------------|---|
| 02 | 00 to 15 | Refrigerant circuit address 00 to 15 |

3. Set the "Primary" and "Secondary" settings.

(Set the indoor unit that is connected to the outdoor unit using a connection cable as the "Primary".)

| Function number | Setting value | Setting description |
|-----------------|---------------|---------------------|
| 51 | 00 | Primary |
| | 01 | Secondary |

4. After completing the function settings, turn off all of the indoor units, and then turn them back on.

* If error code 21, 22, 24, or 27 is displayed, there may be an incorrect setting. Perform the remote controller setting again.

NOTES:

- When different indoor unit models are connected using the group control system, some functions may no longer be available.
- If the group control system contains multiple units that are operated simultaneously, connect and set the units as shown below.
- Auto-changeover operates under the same mode with model R.C. address "00".
- It should not be connected to any other Gr that is not of the same series (A**G only).

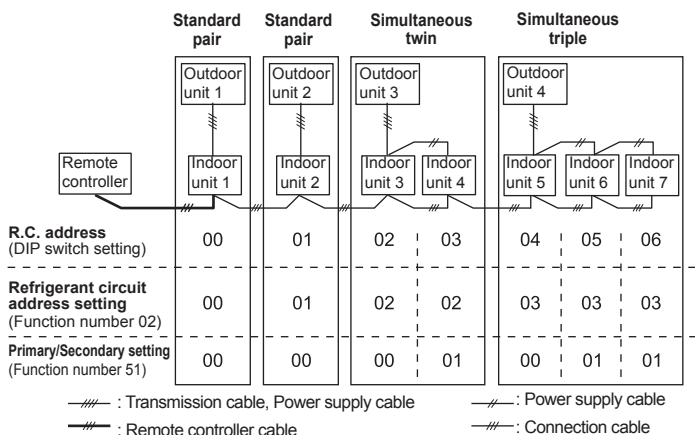

6.2. Multiple remote control

Up to 2 remote controllers can be used to operate the indoor units.

⚠ CAUTION

Multiple installation method described above is prohibited to combine 3 Wired type with 2 Wired Type.

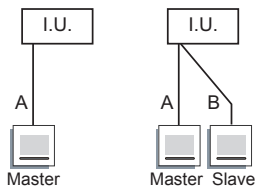

A, B : Remote controller cable. (Refer to "2.5. Electrical requirement".)
A ≤ 500 m, A+B ≤ 500 m

- The timer and self-diagnosis functions cannot be used on the secondary units.

(1) Wiring method (indoor unit to remote controller)

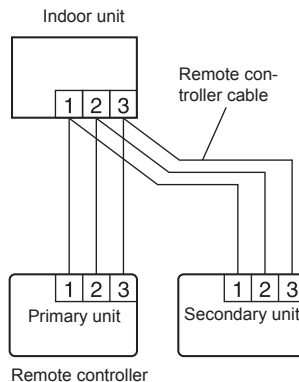

(2) Remote controller DIP switch 1 setting

Set the remote controller DIP switch 1 No. 2 according to the following table.

| | DIP SW 1-No. 2 |
|----------------|----------------|
| Primary unit | OFF |
| Secondary unit | ON |

6.3. Simultaneous multi-system operation

This possible only the wired remote controller (Option)

⚠ CAUTION

- When setting DIP switches, do not touch any other parts on the circuit board directly with your bare hands.
- Be sure to turn off the main power.

- Ensure to use a 3-wire type wired remote controller. (Set the DIP switch to 3-wire type.)
- When using a simultaneous multi system, a WLAN adapter cannot be used.
- If connected to an indoor unit that supports R410A, an error message is displayed. Check the machine type of the indoor unit to connect, and ensure to use an indoor unit supporting R32.
- By combining with an outdoor unit, 2 units for twin and 3 units for triple indoor units, can be switched on/off simultaneously.

(1) Wiring method

- Refer to "3.6. Electrical wiring" for wiring procedure and wiring method.
- The indoor unit is connected the outdoor unit using a connection cable is "primary".
- Connect the remote controller wire to the primary unit.

■ Twin type (18, 22, 24 model only)

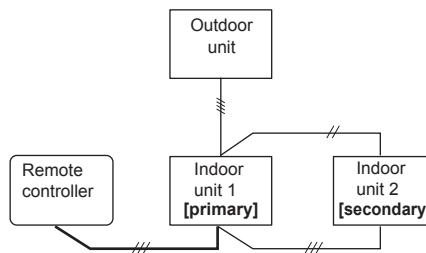

■ Triple type (18 model only)

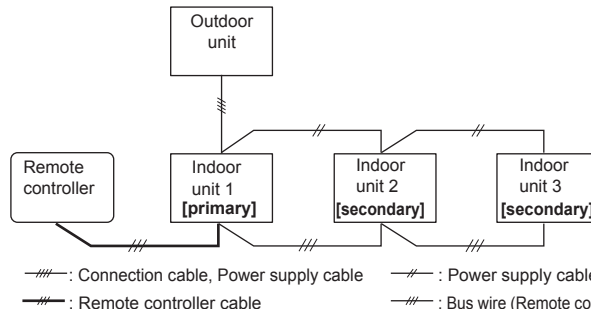

- (2) Set the R.C. address (DIP switch setting)
Set the R.C. address of each indoor unit using the DIP switches on the indoor unit circuit board. (Refer to the following table and figure.)
The DIP switches are normally set to make the R.C. address "00".

| Indoor unit | R.C. address | DIP SWITCH No. | | | |
|-------------|--------------|----------------|-----|-----|-----|
| | | 1 | 2 | 3 | 4 |
| 1 | 00 | OFF | OFF | OFF | OFF |
| 2 | 01 | ON | OFF | OFF | OFF |
| 3 | 02 | OFF | ON | OFF | OFF |

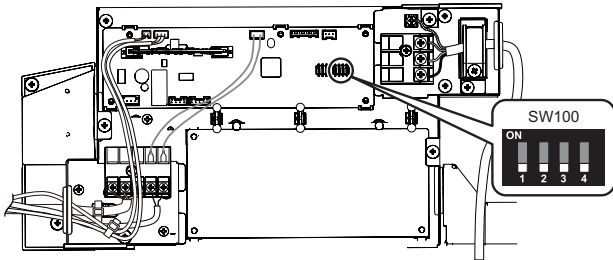

NOTES:

Be sure to set the R.C. address sequentially.

- (3) Set the primary and secondary (Remote controller setting)
1. Turn on all of the indoor units.
 2. Set the "primary" and "secondary" settings.
(Set the indoor unit that is connected to the outdoor unit using a connection cable as the "primary".)

| Function number | Setting value | Setting description |
|-----------------|---------------|---------------------|
| 51 | 00 | Primary |
| | 01 | Secondary |

3. After completing the function settings, turn off all of the indoor units, and then turn them back on.
* If error code 21, 22, 24 or 27 is displayed, there may be an incorrect setting. Perform the remote controller setting again.

■ **Twin type (18, 22, 24 model only)**

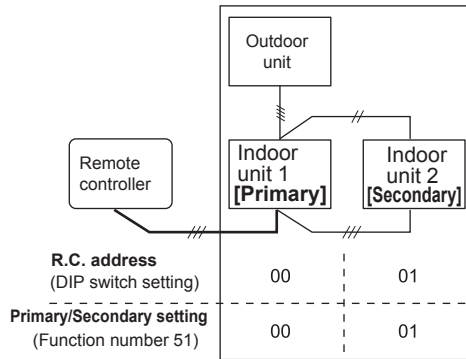

■ **Triple type (18 model only)**

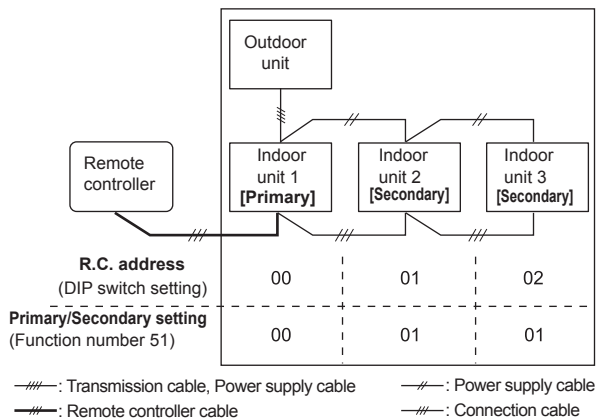

7. FUNCTION SETTING

Perform the Function setting according to the installation conditions using the remote controller.

CAUTION

- Confirm whether the wiring work for outdoor unit has been finished.
- Confirm that the cover for the electrical enclosure on the outdoor unit is in place.

- This procedure changes to the Function settings used to control the indoor unit according to the installation conditions. Incorrect settings can cause the indoor unit to malfunction.
- After the power is turned on, perform the Function setting according to the installation conditions using the remote controller.
- The settings may be selected between the following two: Function number or setting value.
- Settings will not be changed if invalid numbers or setting values are selected.

7.1. Function details

■ **Filter sign**

Select appropriate intervals for displaying the filter sign on the indoor unit according to the estimated amount of dust in the air of the room.

If the indication is not required, select "No indication" (03).

(♦... Factory setting)

| Function number | Setting value | Setting description |
|-----------------|---------------|-----------------------------|
| 11 | 00 | Standard (2500 hours) |
| | 01 | Long interval (4400 hours) |
| | 02 | Short interval (1250 hours) |
| | 03 | No indication ♦ |

■ **Ceiling height**

Select the appropriate ceiling height according to the place of installation.

(♦... Factory setting)

| Function number | Setting value | Setting description |
|-----------------|---------------|---------------------|
| 20 | 00 | Standard (2.7m) ♦ |
| | 01 | High ceiling (3.0m) |

In case of Cassette type models:

The ceiling height values are for the 4-way outlet.

Do not change this setting in the 3-way outlet mode.

7000, 9000 Btu/h models cannot be installed in high ceilings.

Do not change this setting.

■ **Outlet directions**

Select the appropriate number of outlet directions according to the installation conditions.

(♦... Factory setting)

| Function number | Setting value | Setting description |
|-----------------|---------------|---------------------|
| 22 | 00 | 4-way ♦ |
| | 01 | 3-way |

■ Room temperature control for indoor unit sensor

Depending on the installed environment, correction of the room temperature sensor may be required.

Select the appropriate control setting according to the installed environment.

The temperature correction values show the difference from the "Standard setting" (00) (manufacturer's recommended value).

(◆... Factory setting)

| Function number | Setting value | Setting description |
|---------------------|---------------------|--------------------------------|
| 30 (For cooling) | 31 (For heating) | 00 Standard setting ◆ |
| | | 01 No correction 0.0 °C (0 °F) |
| | | 02 -0.5 °C (-1 °F) |
| | | 03 -1.0 °C (-2 °F) |
| | | 04 -1.5 °C (-3 °F) |
| | | 05 -2.0 °C (-4 °F) |
| | | 06 -2.5 °C (-5 °F) |
| | | 07 -3.0 °C (-6 °F) |
| | | 08 -3.5 °C (-7 °F) |
| | | 09 -4.0 °C (-8 °F) |
| | | 10 +0.5 °C (+1 °F) |
| | | 11 +1.0 °C (+2 °F) |
| | | 12 +1.5 °C (+3 °F) |
| | | 13 +2.0 °C (+4 °F) |
| | | 14 +2.5 °C (+5 °F) |
| | | 15 +3.0 °C (+6 °F) |
| | | 16 +3.5 °C (+7 °F) |
| 17 +4.0 °C (+8 °F) | | |

■ Room temperature control for wired remote controller sensor

Depending on the installed environment, correction of the wire remote temperature sensor may be required.

Select the appropriate control setting according to the installed environment.

To change this setting, set Function 42 to "Both" (01).

Ensure that the Thermo Sensor icon is displayed on the remote controller screen.

(◆... Factory setting)

| Function number | Setting value | Setting description |
|---------------------|---------------------|--------------------------------|
| 35 (For cooling) | 36 (For heating) | 00 No correction ◆ |
| | | 01 No correction 0.0 °C (0 °F) |
| | | 02 -0.5 °C (-1 °F) |
| | | 03 -1.0 °C (-2 °F) |
| | | 04 -1.5 °C (-3 °F) |
| | | 05 -2.0 °C (-4 °F) |
| | | 06 -2.5 °C (-5 °F) |
| | | 07 -3.0 °C (-6 °F) |
| | | 08 -3.5 °C (-7 °F) |
| | | 09 -4.0 °C (-8 °F) |
| | | 10 +0.5 °C (+1 °F) |
| | | 11 +1.0 °C (+2 °F) |
| | | 12 +1.5 °C (+3 °F) |
| | | 13 +2.0 °C (+4 °F) |
| | | 14 +2.5 °C (+5 °F) |
| | | 15 +3.0 °C (+6 °F) |
| | | 16 +3.5 °C (+7 °F) |
| 17 +4.0 °C (+8 °F) | | |

■ Auto restart

Enable or disable automatic restart after a power interruption.

(◆... Factory setting)

| Function number | Setting value | Setting description |
|-----------------|---------------|---------------------|
| 40 | 00 | Enable ◆ |
| | 01 | Disable |

* Auto restart is an emergency function such as for power outage etc. Do not attempt to use this function in normal operation. Be sure to operate the unit by remote controller or external device.

■ Room temperature sensor switching

(Only for wireless remote controller)

When using the Wired remote controller temperature sensor, change the setting to "Both" (01). (◆... Factory setting)

| Function number | Setting value | Setting description |
|-----------------|---------------|---------------------|
| 42 | 00 | Indoor unit ◆ |
| | 01 | Both |

00: Sensor on the indoor unit is active.

01: Sensors on both indoor unit and wired remote controller are active.

* Remote controller sensor must be turned on by using the remote controller

■ Remote controller custom code

(Only for wireless remote controller)

The indoor unit custom code can be changed. Select the appropriate custom code. (◆... Factory setting)

| Function number | Setting value | Setting description |
|-----------------|---------------|---------------------|
| 44 | 00 | A ◆ |
| | 01 | B |
| | 02 | C |
| | 03 | D |

■ External input control

"Operation/Stop" mode or "Forced stop" mode can be selected.

(◆... Factory setting)

| Function number | Setting value | Setting description |
|-----------------|---------------|-------------------------|
| 46 | 00 | Operation/Stop mode 1 ◆ |
| | 01 | (Setting prohibited) |
| | 02 | Forced stop mode |
| | 03 | Operation/Stop mode 2 |

■ Room temperature sensor switching (Aux.)

To use the temperature sensor on the wired remote controller only, change the setting to "Wired remote controller" (01). This function will only work if the function setting 42 is set at "Both" (01)

(◆... Factory setting)

| Function number | Setting value | Setting description |
|-----------------|---------------|-------------------------|
| 48 | 00 | Both ◆ |
| | 01 | Wired remote controller |

■ Indoor unit fan control for energy saving for cooling

Enables or disables the power-saving function by controlling the indoor unit fan rotation when the outdoor unit is stopped during cooling operation.

(◆... Factory setting)

| Function number | Setting value | Setting description |
|-----------------|---------------|---------------------|
| 49 | 00 | Disable |
| | 01 | Enable |
| | 02 | Remote controller ◆ |

00: When the outdoor unit is stopped, the indoor unit fan operates continuously following the setting on the remote controller.

01: When the outdoor unit is stopped, the indoor unit fan operates intermittently at a very low speed.

02: Enable or disable this function by remote controller setting.

*When using a wired remote controller without Indoor unit fan control for energy saving for cooling function, or when connecting a single split converter, the setting cannot be made by using the remote controller. Set to (00) or (01).

To confirm if the remote controller has this function, refer to the operating manual of each remote controller.

■ Switching functions for external output terminal

Functions of the external output terminal can be switched.

(◆... Factory setting)

| Function number | Setting value | Setting description |
|-----------------|---------------|----------------------|
| 60 | 00 | Operation status ◆ |
| | 01 to 08 | (Setting prohibited) |
| | 09 | Error status |
| | 10 | Fresh air control |
| | 11 | Auxiliary heater |

■ Setting record

Record any changes to the settings in the following table.

| Setting description | | Setting value |
|---|---------|---------------|
| Filter sign | | |
| Ceiling height | | |
| Outlet directions | | |
| Room temperature control for indoor unit sensor | Cooling | |
| | Heating | |
| Room temperature control for wired remote controller sensor | Cooling | |
| | Heating | |
| Auto restart | | |
| Room temperature sensor switching | | |
| Remote controller custom code | | |
| External input control | | |
| Room temperature sensor switching (Aux.) | | |
| Indoor unit fan control for energy saving for cooling | | |
| Switching functions for external output terminal | | |

After completing the Function Setting, be sure to turn off the power and turn it on again.

8. CHECK LIST

Pay special attention to the check items below when installing the indoor unit(s). After installation is complete, be sure to check the following check items again.

| CHECK ITEMS | If not performed correctly | CHECK BOX |
|--|--|-----------|
| Has the indoor unit been installed correctly? | Vibration, noise, indoor unit may drop | |
| Has there been a check for gas leaks (refrigerant pipes)? | No cooling, No heating | |
| Has heat insulation work been completed? | Water leakage | |
| Does water drain easily from the indoor units? | Water leakage | |
| Are the wires and pipes all connected completely? | No operation, heat or burn damage | |
| Is the connection cable the specified thickness? | No operation, heat or burn damage | |
| Are the inlets and outlets free of any obstacles? | No cooling, No heating | |
| After installation is completed, has the proper operation and handling been explained to the user? | | |

9. TEST RUN

9.1. Check items

- Is operation of each button on the remote controller normal?
- Does each lamp light normally?
- Is the drain normal?
- Do not have an abnormal noise and vibration during operation?

Do not operate the air conditioner in test run for a long time.

9.2. Operation method

Depending on your installation, choose from the following:

■ By the wireless remote controller (with [TEST RUN] button)

- (1) To start test run, press [START/STOP] and [TEST RUN] on the remote controller.
- (2) To end test run, press [START/STOP] on the remote controller.

■ By the indoor unit or IR receiver unit

- (1) To start test run, press [MANUAL AUTO] of the unit for more than 10 seconds (forced cooling).
- (2) To end test run, press [MANUAL AUTO] for more than 3 seconds or press [START/STOP] on the remote controller.
 - The Operation indicator lamp and Timer indicator lamp will simultaneously flash during the test run mode.

■ By the wired remote controller

- (1) For the operation method, refer to the installation manual and the operating manual of the wired remote controller.

Heating test run will begin in a few minutes when HEAT is selected by the remote controller [reverse cycle model only].

10. FINISHING

10.1. Installing heat insulation

⚠ CAUTION

- After checking for gas leaks (refer to the Installation Manual of the outdoor unit), perform this section.
- Install heat insulation around both the large (gas) and small (liquid) pipes. Failure to do so may cause water leaks.
- Must fit tightly against body without any gap.

After checking for gas leaks, insulate by wrapping insulation around the 2 parts (gas and liquid) of the indoor unit coupling, using the Coupler Heat Insulation.

After installing the Coupler Heat Insulation, wrap both ends with vinyl tape so that there is no gap.

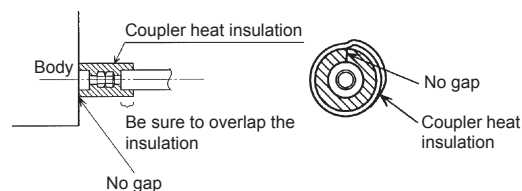

11. CUSTOMER GUIDANCE

Explain the following to the customer in accordance with the operating manual:

- (1) Starting and stopping method, operation switching, temperature adjustment, timer, air flow switching, and other remote controller operations.
- (2) Cleaning and maintenance of the product, and other items such as air filters and air louvers if applicable.
- (3) Give the operating and installation manuals to the customer.
- (4) If the indoor unit custom code is changed, and the installation includes a wireless remote controller, inform the customer the changed code. (On some wireless remote controllers, the custom code may return to A when batteries are replaced.)

12. ERROR CODES

If you use a wireless remote controller, the lamp on the photo detector unit will output error codes by way of blinking patterns. If you use a wired remote controller, error codes will appear on the remote control display. Refer to the lamp blinking patterns and error codes in the table. An error display is displayed only during operation.

| Error display | | | Error code | Description |
|------------------------|---------------------|----------------------|------------|---|
| OPERATION lamp (green) | TIMER lamp (orange) | ECONOMY lamp (green) | | |
| ●(1) | ●(1) | ◇ | 11 | Serial communication error |
| ●(1) | ●(2) | ◇ | 12 | • Wired remote controller communication error • Server room control communication error |
| ●(1) | ●(5) | ◇ | 15 | Check run unfinished Automatic airflow adjustment error |
| ●(1) | ●(6) | ◇ | 16 | Peripheral unit transmission PCB connection error |
| ●(1) | ●(8) | ◇ | 18 | External communication error |
| ●(2) | ●(1) | ◇ | 21 | Unit number or Refrigerant circuit address setting error [Simultaneous Multi] |
| ●(2) | ●(2) | ◇ | 22 | Indoor unit capacity error |
| ●(2) | ●(3) | ◇ | 23 | Combination error |
| ●(2) | ●(4) | ◇ | 24 | • Connection unit number error (indoor secondary unit) [Simultaneous Multi] • Connection unit number error (indoor unit or branch unit) [Flexible Multi] |
| ●(2) | ●(6) | ◇ | 26 | Indoor unit address setting error |
| ●(2) | ●(7) | ◇ | 27 | Primary unit, secondary unit setup error [Simultaneous Multi] |
| ●(2) | ●(9) | ◇ | 29 | Connection unit number error in wired remote controller system |
| ●(3) | ●(1) | ◇ | 31 | Power supply interruption error |

| Error display | | | Error code | Description |
|------------------------|---------------------|----------------------|------------|---|
| OPERATION lamp (green) | TIMER lamp (orange) | ECONOMY lamp (green) | | |
| ●(3) | ●(2) | ◇ | 32 | Indoor unit PCB model information error |
| ●(3) | ●(3) | ◇ | 33 | Indoor unit motor electricity consumption detection error |
| ●(3) | ●(5) | ◇ | 35 | Manual auto switch error |
| ●(3) | ●(9) | ◇ | 39 | Indoor unit power supply error for fan motor |
| ●(3) | ●(10) | ◇ | 3A | Indoor unit communication circuit (wired remote controller) error |
| ●(4) | ●(1) | ◇ | 41 | Room temp. sensor error |
| ●(4) | ●(2) | ◇ | 42 | Indoor unit heat ex. middle temp. sensor error |
| ●(4) | ●(4) | ◇ | 44 | Human sensor error |
| ●(5) | ●(1) | ◇ | 51 | Indoor unit fan motor error |
| ●(5) | ●(3) | ◇ | 53 | Drain pump error |
| ●(5) | ●(4) | ◇ | 54 | Electric air cleaner reverse VDD error |
| ●(5) | ●(5) | ◇ | 55 | Filter set error |
| ●(5) | ●(7) | ◇ | 57 | Damper error |
| ●(5) | ●(8) | ◇ | 58 | Intake grille error |
| ●(5) | ●(9) | ◇ | 59 | Indoor unit fan motor 2 error (Left side fan) |
| ●(5) | ●(10) | ◇ | 5A | Indoor unit fan motor 3 error (Right side fan) |
| ●(5) | ●(15) | ◇ | 5U | Indoor unit error |
| ●(6) | ●(1) | ◇ | 61 | Outdoor unit reverse/missing phase and wiring error |
| ●(6) | ●(2) | ◇ | 62 | Outdoor unit main PCB model information error or communication error |
| ●(6) | ●(3) | ◇ | 63 | Inverter error |
| ●(6) | ●(4) | ◇ | 64 | Active filter error, PFC circuit error |
| ●(6) | ●(5) | ◇ | 65 | Trip terminal L error |
| ●(6) | ●(8) | ◇ | 68 | Outdoor unit rush current limiting resistor temp. rise error |
| ●(6) | ●(10) | ◇ | 6A | Display PCB microcomputers communication error |
| ●(7) | ●(1) | ◇ | 71 | Discharge temp. sensor error |
| ●(7) | ●(2) | ◇ | 72 | Compressor temp. sensor error |
| ●(7) | ●(3) | ◇ | 73 | Outdoor unit Heat Ex. liquid temp. sensor error |
| ●(7) | ●(4) | ◇ | 74 | Outdoor temp. sensor error |
| ●(7) | ●(5) | ◇ | 75 | Suction Gas temp. sensor error |
| ●(7) | ●(6) | ◇ | 76 | • 2-way valve temp. sensor error • 3-way valve temp. sensor error |
| ●(7) | ●(7) | ◇ | 77 | Heat sink temp. sensor error |
| ●(8) | ●(2) | ◇ | 82 | • Sub-cool Heat Ex. gas inlet temp. sensor error • Sub-cool Heat Ex. gas outlet temp. sensor error |
| ●(8) | ●(3) | ◇ | 83 | Liquid pipe temp. sensor error |
| ●(8) | ●(4) | ◇ | 84 | Current sensor error |

| Error display | | | Error code | Description |
|------------------------|---------------------|----------------------|------------|--|
| OPERATION lamp (green) | TIMER lamp (orange) | ECONOMY lamp (green) | | |
| ●(8) | ●(6) | ◇ | 86 | • Discharge pressure sensor error • Suction pressure sensor error • High pressure switch error |
| ●(9) | ●(4) | ◇ | 94 | Trip detection |
| ●(9) | ●(5) | ◇ | 95 | Compressor rotor position detection error (permanent stop) |
| ●(9) | ●(7) | ◇ | 97 | Outdoor unit fan motor 1 error |
| ●(9) | ●(8) | ◇ | 98 | Outdoor unit fan motor 2 error |
| ●(9) | ●(9) | ◇ | 99 | 4-way valve error |
| ●(9) | ●(10) | ◇ | 9A | Coil (expansion valve) error |
| ●(10) | ●(1) | ◇ | A1 | Discharge temp. error |
| ●(10) | ●(3) | ◇ | A3 | Compressor temp. error |
| ●(10) | ●(4) | ◇ | A4 | High pressure error |
| ●(10) | ●(5) | ◇ | A5 | Low pressure error |
| ●(13) | ●(2) | ◇ | J2 | Branch boxes error [Flexible Multi] |

Display mode ● : 0.5s ON / 0.5s OFF

◇ : 0.1s ON / 0.1s OFF

() : Number of flashing

■ Error display on the indoor unit

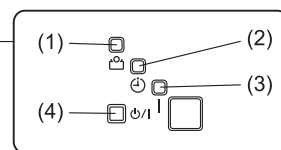
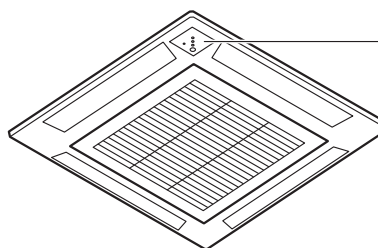

- (1) ECONOMY indicator lamp (Green)
- (2) Timer indicator lamp (Orange)
- (3) Operation indicator lamp (Green)
- (4) Manual auto button