

AIR CONDITIONER

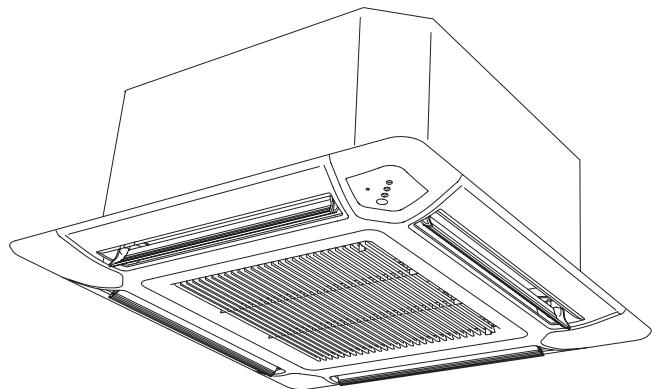

INSTALLATION MANUAL

INDOOR UNIT (Compact cassette type)
For authorized service personnel only.

English

INSTALLATIONSANLEITUNG

INNENGERÄT (Typ kompakt-kassette)
Nur für autorisiertes Fachpersonal.

Deutsch

MANUEL D'INSTALLATION

UNITÉ INTÉRIEURE (Type cassette compacte)
Pour le personnel de service agréé uniquement.

Français

MANUAL DE INSTALACIÓN

UNIDAD INTERIOR (Tipo caja compacta)
Únicamente para personal de servicio autorizado.

Español

MANUALE D'INSTALLAZIONE

UNITÀ INTERNA (Tipo a cassetta compatta)
A uso esclusivo del personale tecnico autorizzato.

Italiano

ΕΓΧΕΙΡΙΔΙΟ ΕΓΚΑΤΑΣΤΑΣΗΣ

ΕΣΩΤΕΡΙΚΗ ΜΟΝΑΔΑ (Τύπος συμπαγούς κασετας)
Μόνο για εξουσιοδοτημένο τεχνικό προσωπικό.

Ελληνικά

MANUAL DE INSTALAÇÃO

UNIDADE INTERNA (Tipo cassete)
Somente para o pessoal do serviço técnico autorizado.

Português

РУКОВОДСТВО ПО УСТАНОВКЕ

ВНУТРЕННИЙ БЛОК (Компактного кассетного типа)
Только для авторизованного обслуживающего персонала.

Русский

KURULUM KILAVUZU

İÇ ÜNİTE (Kompakt kaset tipi)
Yalnızca yetkili servis personeli için.

Türkçe

[Original instructions]



PART No. 9379124010-07

INSTALLATION MANUAL

PART No. 9379124010-07

INDOOR UNIT (Compact cassette type)

Contents

1. SAFETY PRECAUTIONS.....	1
2. ABOUT THIS PRODUCT.....	1
2.1. Precautions for using R410A refrigerant.....	1
2.2. Special tool for R410A.....	1
2.3. Accessories.....	1
2.4. Cassette grille accessories.....	2
2.5. Optional parts.....	2
3. INSTALLATION WORK.....	2
3.1. Selecting an installation location.....	2
3.2. Installation dimension.....	3
3.3. Installation the unit.....	3
4. INSTALLING DRAIN PIPES.....	4
5. PIPE INSTALLATION.....	5
5.1. Selecting the pipe material.....	5
5.2. Pipe requirement.....	5
5.3. Flare connection (pipe connection).....	5
5.4. Installing heat insulation.....	6
6. ELECTRICAL WIRING.....	6
6.1. Wiring system diagram.....	7
6.2. Connection cable preparation.....	8
6.3. Connection of wiring.....	8
7. REMOTE CONTROLLER SETTING.....	8
7.1. Load batteries (R03/LR03 × 2).....	8
7.2. Installing the remote controller holder.....	9
8. CASSETTE GRILLE INSTALLATION.....	9
8.1. Remove the intake grille.....	9
8.2. Installing the panel to indoor unit.....	9
8.3. Attach the intake grille.....	10
9. FUNCTION SETTING.....	10
9.1. Operation method.....	10
9.2. Function setting.....	10
9.3. Remote controller custom code setting.....	11
9.4. Special installation methods.....	12
10. TEST RUN.....	14
11. CHECK LIST.....	14
12. OPTIONAL KIT INSTALLATION (OPTION).....	14
13. CUSTOMER GUIDANCE.....	14
14. ERROR CODES.....	14

1. SAFETY PRECAUTIONS

- Be sure to read this Manual thoroughly before installation.
- The warnings and precautions indicated in this Manual contain important information pertaining to your safety. Be sure to observe them.
- Hand this Manual, together with the Operating Manual, to the customer. Request the customer to keep them on hand for future use, such as for relocating or repairing the unit.

 WARNING	This mark indicates procedures which, if improperly performed, might lead to the death or serious injury of the user.
Request your dealer or a professional installer to install the indoor unit in accordance with this Installation Manual. An improperly installed unit can cause serious accidents such as water leakage, electric shock, or fire. If the indoor unit is installed in disregard of the instructions in the Installation Manual, it will void the manufacturer's warranty.	
Do not turn ON the power until all work has been completed. Turning ON the power before the work is completed can cause serious accidents such as electric shock or fire.	
If refrigerant leaks while work is being carried out, ventilate the area. If the refrigerant comes in contact with a flame, it produces a toxic gas.	
Installation work must be performed in accordance with national wiring standards by authorized personnel only.	
This appliance is not intended for use by persons (including children) with reduced physical, sensory or mental capabilities, or lack of experience and knowledge, unless they have been given supervision or instruction concerning use of the appliance by a person responsible for their safety. Children should be supervised to ensure that they do not play with the appliance.	

 CAUTION	This mark indicates procedures which, if improperly performed, might possibly result in personal harm to the user, or damage to property.
Read carefully all security information before use or install the air conditioner.	
Do not attempt to install the air conditioner or a part of the air conditioner by yourself.	
This unit must be installed by qualified personnel with a capacity certificate for handling refrigerant fluids. Refer to regulation and laws in use on installation place.	
The installation must be carried out in compliance with regulations in force in the place of installation and the installation instructions of the manufacturer.	
This unit is part of a set constituting an air conditioner. It must not be installed alone or with non-authorized by the manufacturer.	
Always use a separate power supply line protected by a circuit breaker operating on all wires with a distance between contact of 3mm for this unit.	

The unit must be correctly earthed (grounded) and the supply line must be equipped with a differential breaker in order to protect the persons.
The units are not explosion proof and therefore should not be installed in explosive atmosphere.
Never touch electrical components immediately after the power supply has been turned off. Electric shock may occur. After turning off the power, always wait 5 minutes before touching electrical components.
This unit contains no user-serviceable parts. Always consult authorized service personnel to repairs.
When moving, consult authorized service personnel for disconnection and installation of the unit.

2. ABOUT THIS PRODUCT

2.1. Precautions for using R410A refrigerant

 WARNING
Do not introduce any substance other than the prescribed refrigerant into the refrigeration cycle. If air enters the refrigeration cycle, the pressure in the refrigeration cycle will become abnormally high and cause the piping to rupture.
If there is a refrigerant leak, make sure that it does not exceed the concentration limit. If a refrigerant leak exceeds the concentration limit, it can lead to accidents such as oxygen starvation.
Do not touch refrigerant that has leaked from the refrigerant pipe connections or other area. Touching the refrigerant directly can cause frostbite.
If a refrigerant leak occurs during operation, immediately vacate the premises and thoroughly ventilate the area. If the refrigerant comes in contact with a flame, it produces a toxic gas.

2.2. Special tool for R410A













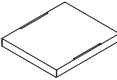
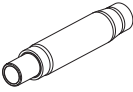

 WARNING
To install a unit that uses R410A refrigerant, use dedicated tools and piping materials that have been manufactured specifically for R410A use. Because the pressure of R410A refrigerant is approximately 1.6 times higher than the R22, failure to use dedicated piping material or improper installation can cause rupture or injury. Furthermore, it can cause serious accidents such as water leakage, electric shock, or fire.

Tool name	Changes
Gauge manifold	The pressure in the refrigerant system is extremely high and cannot be measured with a conventional gauge. To prevent erroneous mixing of other refrigerants, the diameter of each port has been changed. It is recommended to use a gauge manifold with a high pressure display range of -0.1 to 5.3 MPa and a low pressure display range of -0.1 to 3.8 MPa.
Charging hose	To increase pressure resistance, the hose material and base size were changed. (The charging port thread diameter for R410A is 1/2 UNF 20 threads per inch.)
Vacuum pump	A conventional vacuum pump can be used by installing a vacuum pump adapter. Be sure that the pump oil does not back flow into the system. Use one capable for vacuum suction of -100.7 kPa (5 Torr, -755 mmHg).
Gas leakage detector	Special gas leakage detector for R410A refrigerant.

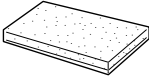
2.3. Accessories





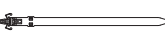

 WARNING
For installation purposes, be sure to use the parts supplied by the manufacturer or other prescribed parts. The use of non-prescribed parts can cause serious accidents such as the unit to fall, water leakage, electric shock, or fire.

- The following installation parts are furnished. Use them as required.
- Keep the Installation Manual in a safe place and do not discard any other accessories until the installation work has been completed.

Name and Shape	Q'ty	Description
Operating Manual 	1	
Installation Manual 	1	(This book)
Coupler heat insulation (Large) 	1	For indoor side pipe joint (Gas pipe)
Coupler heat insulation (Small) 	1	For indoor side pipe joint (Liquid pipe)
Special nut A (Large flange) 	4	For installing indoor unit
Special nut B (Small flange) 	4	For installing indoor unit
Template (Carton top) 	1	For ceiling openings cutting Also used as packing
Drain hose 	1	For installing drain pipe VP25 (O.D.32, I.D.25)
Hose Band 	1	For installing drain hose
Drain hose insulation 	1	For installing drain pipe
Remote controller 	1	For air conditioner operation
Battery 	2	For remote controller unit
Remote controller holder 	1	For installing the remote controller
Tapping screw 	2	For mounting the remote controller holder
Cable-tie 	2	For electrical wiring
Wire clammer 	1	For electrical wiring

(*1) This part is not furnished for AUT* series

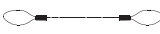
2.4. Cassette grille accessories

Name and Shape	Q'ty	Description
Connector cover 	1	For covering connector
Tapping Screw (M5 × 12 mm) 	4	For mounting cassette grille
Tapping Screw (M4 × 12 mm) 	1	For mounting connector cover
L angle 	2	For mounting the Hook Wire to the Cassette grille
Hook wire 	2	For suspending the Cassette grille
Screw [pitch small] (M4 × 10 mm) 	2	For mounting the Hook Wire (for metals)
Screw [pitch large] (M4 × 10 mm) 	4	For mounting the L angle and Hook wire (for resins)

2.5. Optional parts

Parts name	Model No.	Summary
Wired remote controller	UTY-RNN*M	Unit control is performed by wired remote controller
Simple Remote Controller	UTY-RSN*M	For air conditioner operation
Air outlet shutter plate	UTR-YDZB	Install the plate at outlet when carrying out 3-way direction operation
Insulation kit for High humidity	UTZ-KXGC	Install when the condition under the roof is over 80% in humidity and over 30°C in temperature.
External connect kit	UTY-XWZX	For control input/output port
Fresh air intake kit	UTZ-VXAA	To take fresh air

Wired remote controller is recommended using simultaneous twin or triple connection.

3. INSTALLATION WORK

Especially, the installation place is very important for the split type air conditioner because it is very difficult to move from place to place after the first installation.

3.1. Selecting an installation location

Decide the mounting position together with the customer as follows.

WARNING

Select installation locations that can properly support the weight of the indoor unit. Install the units securely so that they do not topple or fall.

CAUTION

Do not install the indoor unit in the following areas:

- Area with high salt content, such as at the seaside. It will deteriorate metal parts, causing the parts to fail or the unit to leak water.
- Area filled with mineral oil or containing a large amount of splashed oil or steam, such as a kitchen. It will deteriorate plastic parts, causing the parts to fail or the unit to leak water.
- Area that generates substances that adversely affect the equipment, such as sulfuric gas, chlorine gas, acid, or alkali. It will cause the copper pipes and brazed joints to corrode, which can cause refrigerant leakage.
- Area that can cause combustible gas to leak, contains suspended carbon fibers or flammable dust, or volatile inflammables such as paint thinner or gasoline. If gas leaks and settles around the unit, it can cause a fire.
- Area where animals may urinate on the unit or ammonia may be generated.

Do not install where there is the danger of combustible gas leakage.

Do not install the unit near a source of heat, steam, or flammable gas.

Install the indoor unit, outdoor unit, power supply cable, connection cable, and remote control cable at least 1 m away from a television or radio receivers. The purpose of this is to prevent TV reception interference or radio noise. (Even if they are installed more than 1 m apart, you could still receive noise under some signal conditions.)

If children under 10 years old may approach the unit, take preventive measures so that they cannot reach the unit.

Use the "Insulation kit for high humidity" (option), when the condition under the roof is over 80% in humidity and over 30°C in temperature. Otherwise, there is a risk of condensation on the ceiling.

- (1) Install the indoor unit in a location having sufficient strength to support the weight of the indoor unit.
- (2) The inlet and outlet ports should not be obstructed; the air should be able to blow all over the room.
- (3) Leave the space required to service the air conditioner.
- (4) Locate where the air can be distributed evenly throughout the room by the unit.
- (5) Install the unit where connection to the outdoor unit is easy.
- (6) Install the unit where the connection pipe can be easily installed.
- (7) Install the unit where the drain pipe can be easily installed.
- (8) Install the unit where noise and vibration is not amplified.
- (9) Take servicing, etc., into consideration and leave the spaces. Also install the unit where the filter can be removed.

3.2. Installation dimension

- The ceiling rear height as shown in the figure.

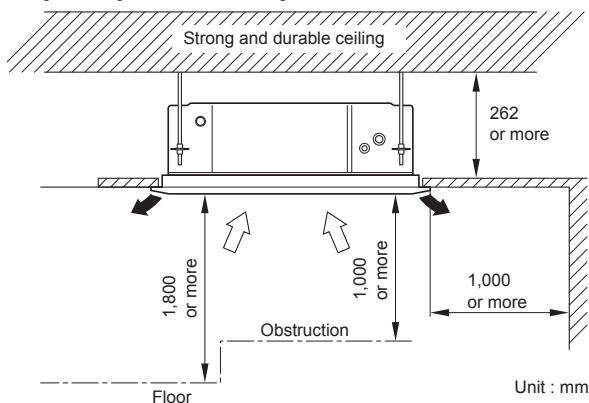

- This product can be installed at a height of up to 3,000mm. However, 7000, 9000 Btu/h model can not be installed in high places. Perform the Function Setting on the remote control in accordance with the installed height. (See 9.2. Function setting)

Discharge direction setting

- The discharge direction can be selected as shown below.

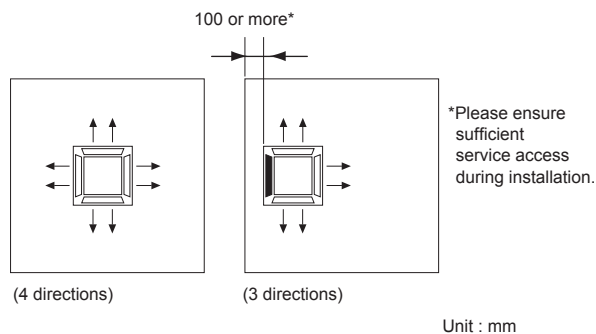

- For a 3-way outlet, make sure to perform the Function Setting on the remote control. Also, make sure to use the optional shutter plate to block the outlet.
- The ceiling height cannot be set in the 3-way outlet mode. Therefore, do not change the setting in the setting the ceiling height. (See 9.2. Function setting)
- When the outlet is shut, be sure to install the optional Air outlet shutter plate kit. For the details of installation, please refer to Installation Manual of kit.

3.3. Installation the unit

WARNING

Install the air conditioner in a location which can withstand a load of at least 5 times the weight of the main unit and which will not amplify sound or vibration. If the installation location is not strong enough, the indoor unit may fall and cause injuries.

If the job is done with the panel frame only, there is a risk that the unit will come loose. Please take care.

3.3.1. Position the ceiling hole and hanging bolts

Ceiling openings and hanging bolt installation diagram.

WARNING

When fastening the hangers, make the bolt positions uniform.

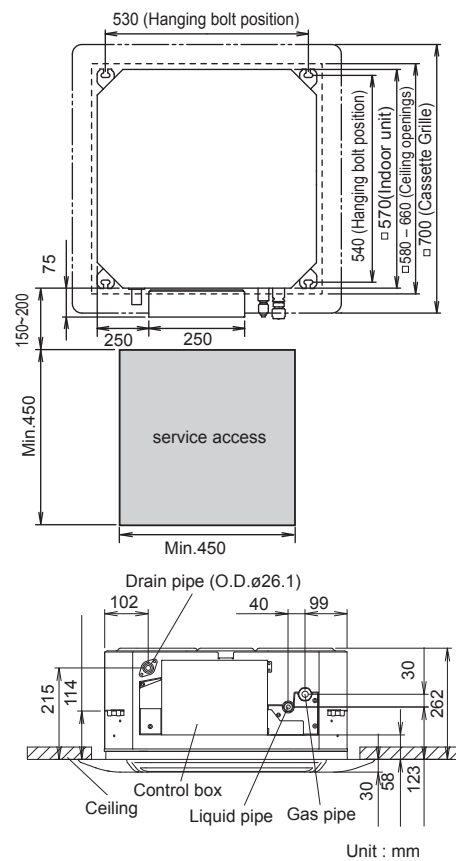

Be sure to keep sufficient space in the designated position for future maintenance.

3.3.2. Body installation

- (1) Install special nut A, then special nut B onto the hanging bolt.
- (2) Raise the body and mount its hooks onto the hanging bolt between the special nuts.
- (3) Turn special nut B to adjust the height of the body.

WARNING

Perform final tightening by tightening the double nut firmly.

Be sure to install the body horizontally and adjust the height below the body and the ceiling surface properly.

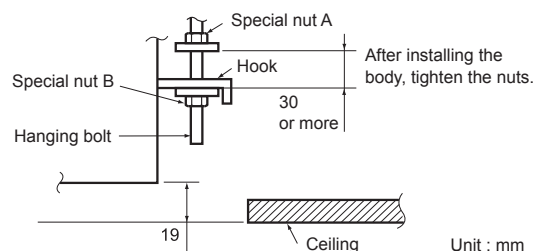

3.3.3. Leveling

Using a level, or vinyl hose filled with water, fine adjust so that the body is level. Inclined installation so as the drain pipe side is higher may cause a malfunction of the float switch, and may cause water leakage.

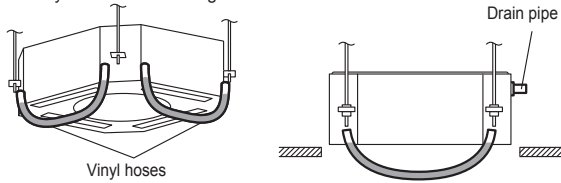

4. INSTALLING DRAIN PIPES

! WARNING

Do not insert the drain piping into the sewer where sulfurous gas occurs. (Heat exchange erosion may occur)

Insulate the parts properly so that water will not drip from the connection parts.

Check for proper drainage after installation by using the visible portion of transparent drain port and the drain piping final outlet on the body.

! CAUTION

Do not apply adhesive agent on the drain port of the body. (Use the attached drain hose assembly to connect the drain piping)

NOTES: Install the drain pipe.

- Install the drain pipe with downward gradient (1/50 to 1/100) and so there are no rises or traps in the pipe.
- Use general hard polyvinyl chloride pipe (VP25) [outside diameter 32mm] and connect it with adhesive (polyvinyl chloride) so that there is no leakage.
- When the pipe is long, install supporters.
- Do not perform air bleeding.
- Always heat insulate indoor section of drain pipe.
- If it is impossible to have sufficient gradient of pipe, perform drain lift-up.

Pipe size	
Drain pipe	VP25 (O.D. 32 mm)

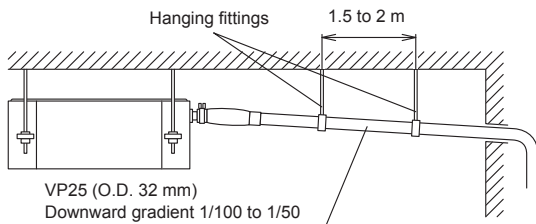

PROHIBITED:

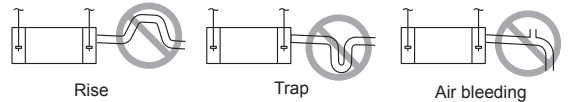

When lifting up drain:

- Height of inclined pipe should be less than 700 mm from the ceiling. A rise dimension over this range will cause leakage.
- Lift up the pipe vertically at the position of 300 mm or less from the unit.

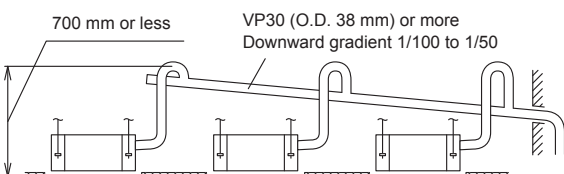
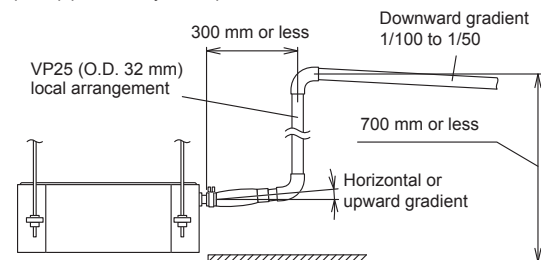

Installation procedure

- 1) Install the attached drain hose to the drain port of the body. Install the hose band from the top of the hose within the shown in the figure area.
- 2) Use vinyl adhesive agent to glue the drain piping (PVC pipe VP25) to the drain hose assembly. (Apply color adhesive agent evenly until the gauge line and seal)
- 3) Check the drainage. (See separate diagram)
- 4) Install the heat insulation.
- 5) Use the attached heat insulation to insulate the drain port and hose band.

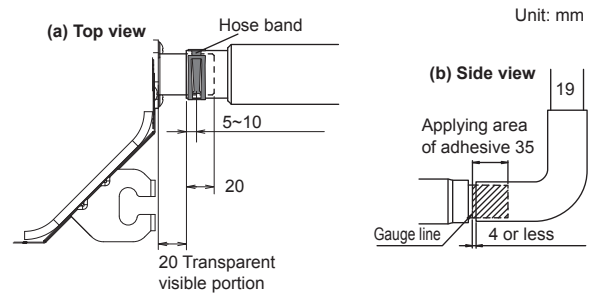
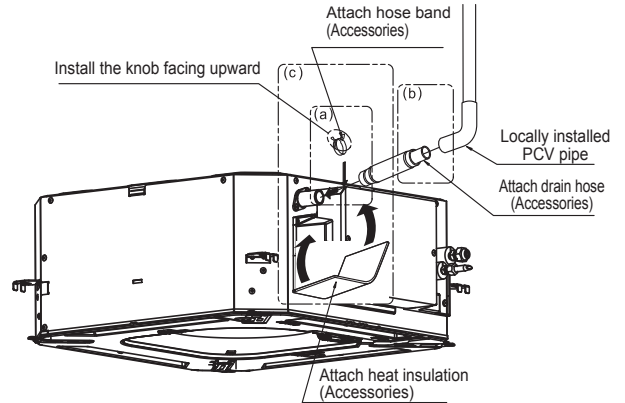

(c) Hose opening view

Wind the attached heat insulation around the hose band

Make sure the alignment is on top

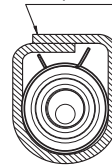

• Top view

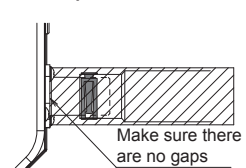

NOTES:

Check for drainage

Pour about 1 liter of water from the position shown in the diagram or from the airflow outlet to the dew tray. Check for any abnormalities such as strange noises and whether the drain pump functions normally

The drain pump operates when operating in the cooling mode.

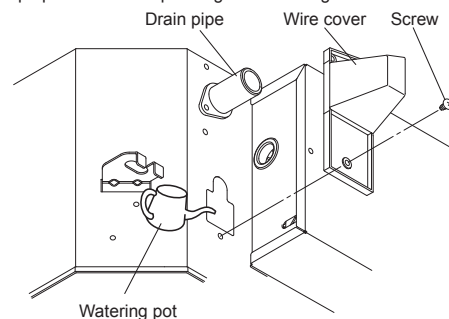

5. PIPE INSTALLATION

CAUTION

Be careful that foreign matter (oil, water, etc.) does not enter the piping with refrigerant R410A models. Also, when storing the piping, securely seal the openings by pinching, taping, etc.

While brazing the pipes, be sure to purge with dry nitrogen gas.

5.1. Selecting the pipe material

CAUTION

Do not use existing pipes.

Use pipes that have clean external and internal sides without any contamination which may cause trouble during use, such as sulfur, oxide, dust, cutting waste, oil or water.

It is necessary to use seamless copper pipes.
Material: Phosphor deoxidized seamless copper pipes.
It is desirable that the amount of residual oil is less than 40 mg/10 m.

Do not use copper pipes that have a collapsed, deformed, or discolored portion (especially on the interior surface). Otherwise, the expansion valve or capillary tube may become blocked with contaminants.

Improper pipe selection will degrade performance. As an air conditioner using R410A incurs pressure higher than when using conventional refrigerant, it is necessary to choose adequate materials.

- Thicknesses of copper pipes used with R410A are as shown in the table.
- Never use copper pipes thinner than those indicated in the table even if they are available on the market.

Thicknesses of Annealed Copper Pipes (R410A)

Pipe outside diameter [mm (in.)]	Thickness [mm]
6.35 (1/4)	0.80
9.52 (3/8)	0.80
12.70 (1/2)	0.80
15.88 (5/8)	1.00
19.05 (3/4)	1.20

5.2. Pipe requirement

CAUTION

Refer to the Installation Manual of the outdoor unit for description of the length and the diameter of connecting pipe or for difference of its elevation.

- Use pipe with water-resistant heat insulation.

CAUTION

Install heat insulation around both the gas and liquid pipes. Failure to do so may cause water leaks.
Use heat insulation with heat resistance above 120 °C. (Reverse cycle model only)
In addition, if the humidity level at the installation location of the refrigerant piping is expected to exceed 70%, install heat insulation around the refrigerant piping. If the expected humidity level is 70-80%, use heat insulation that is 15 mm or thicker and if the expected humidity exceeds 80%, use heat insulation that is 20 mm or thicker. If heat insulation is used that is not as thick as specified, condensation may form on the surface of the insulation.
In addition, use heat insulation with heat conductivity of 0.045W/(m·K) or less (at 20 °C).

5.3. Flare connection (pipe connection)

5.3.1. Flaring

- Use special pipe cutter and flare tool exclusive for R410A.
 - (1) Cut the connection pipe to the necessary length with a pipe cutter.
 - (2) Hold the pipe downward so that cuttings will not enter the pipe and remove any burrs.
 - (3) Insert the flare nut (always use the flare nut attached to the indoor and outdoor units respectively) onto the pipe and perform the flare processing with a flare tool. Leakage of refrigerant may result if other flare nuts are used.
 - (4) Protect the pipes by pinching them or with tape to prevent dust, dirt, or water from entering the pipes.

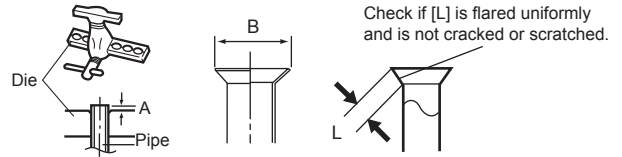

Pipe outside diameter [mm (in.)]	Dimension A [mm]	Dimension B _{0.4} [mm]
	Flare tool for R410A, clutch type	
6.35 (1/4)	0 to 0.5	9.1
9.52 (3/8)		13.2
12.70 (1/2)		16.6
15.88 (5/8)		19.7
19.05 (3/4)		24.0

When using conventional flare tools to flare R410A pipes, the dimension A should be approximately 0.5 mm more than indicated in the table (for flaring with R410A flare tools) to achieve the specified flaring. Use a thickness gauge to measure the dimension A.

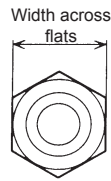

Pipe outside diameter [mm (in.)]	Width across flats of Flare nut [mm]
6.35 (1/4)	17
9.52 (3/8)	22
12.70 (1/2)	26
15.88 (5/8)	29
19.05 (3/4)	36

5.3.2 Bending pipes

CAUTION

To prevent breaking of the pipe, avoid sharp bends.

If the pipe is bent repeatedly at the same place, it will break.

- If pipes are shaped by hand, be careful not to collapse them.
- Do not bend the pipes at an angle more than 90°.
- When pipes are repeatedly bent or stretched, the material will harden, making it difficult to bend or stretch them any more.
- Do not bend or stretch the pipes more than 3 times.

5.3.3. Pipe connection

CAUTION

Be sure to connect the pipe against the port on the indoor unit and the outdoor unit correctly. If the centering is improper, the flare nut cannot be tightened smoothly. If the flare nut is forced to turn, the threads will be damaged.

Do not remove the flare nut from the indoor unit pipe until immediately before connecting the connection pipe.

Do not use mineral oil on flared part. Prevent mineral oil from getting into the system as this would reduce the lifetime of the units.

- (1) Detach the caps and plugs from the pipes.
- (2) Center the pipe against the port on the indoor unit, and then turn the flare nut by hand.

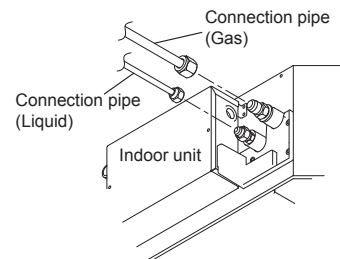

(3) When the flare nut is tightened properly by your hand, hold the body side coupling with a separate spanner, then tighten with a torque wrench. (See the table below for the flare nut tightening torques.

CAUTION

Hold the torque wrench at its grip, keeping it in the right angle with the pipe, in order to tighten the flare nut correctly.

Tighten the flare nuts with a torque wrench using the specified tightening method. Otherwise, the flare nuts could break after a prolonged period, causing refrigerant to leak and generate a hazardous gas if the refrigerant comes into contact with a flame.

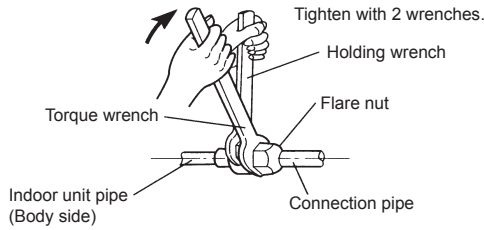

Flare nut [mm (in.)]	Tightening torque [N·m (kgf·cm)]
6.35 (1/4) dia.	16 to 18 (160 to 180)
9.52 (3/8) dia.	32 to 42 (320 to 420)
12.70 (1/2) dia.	49 to 61 (490 to 610)
15.88 (5/8) dia.	63 to 75 (630 to 750)
19.05 (3/4) dia.	90 to 110 (900 to 1,100)

5.4. Installing heat insulation

CAUTION

After checking for gas leaks (refer to the Installation Manual of the outdoor unit), perform this section.

Install heat insulation around both the large (gas) and small (liquid) pipes. Failure to do so may cause water leaks.

Must fit tightly against body without any gap.

After checking for gas leaks, insulate by wrapping insulation around the 2 parts (gas and liquid) of the indoor unit coupling, using the Coupler Heat Insulation. After installing the Coupler Heat Insulation, wrap both ends with vinyl tape so that there is no gap.

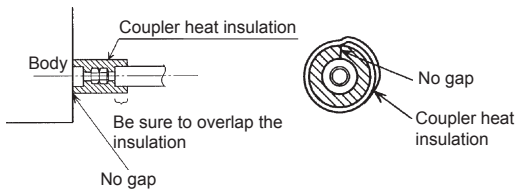

6. ELECTRICAL WIRING

Cable	Cable size (mm ²)	Type	Remarks
Connection cable	1.5 (MIN.)	Type 60245 IEC57	3Cable+Earth (Ground), 1φ230V

Max. Cable Length: Limit voltage drop to less than 2%. Increase cable gauge if voltage drop is 2% or more.

For simultaneous multi

Bus wire	Conductor size (mm ²)	Max length (m)
Bus wire	0.3 (MIN.)	500*

*This length shall be the total extended length in the system of the group. (Total length of bus wire and remote controller cable.)

WARNING

Electrical work must be performed in accordance with this Manual by a person certified under the national or regional regulations. Be sure to use a dedicated circuit for the unit. An insufficient power supply circuit or improperly performed electrical work can cause serious accidents such as electric shock or fire.

Before starting work, check that power is not being supplied to the indoor unit and outdoor unit.

Use the included connection cables and power cables or ones specified by the manufacturer. Improper connections, insufficient insulation, or exceeding the allowable current can cause electric shock or fire.

For wiring, use the prescribed type of wires, connect them securely, making sure that there are no external forces of the wires applied to the terminal connections. Improperly connected or secured wires can cause serious accidents such as overheating the terminals, electric shock, or fire.

Do not modify the power cables, use extension cables, or use any branches in the wiring. Improper connections, insufficient insulation, or exceeding the allowable current can cause electric shock or fire.

Match the terminal block numbers and connection cable colors with those of the outdoor unit or branch box. Erroneous wiring may cause burning of the electric parts.

Securely connect the connection cables to the terminal blocks. In addition, secure the cables with wiring holders. Improper connections, either in the wiring or at the ends of the wiring, can cause a malfunction, electric shock, or fire.

Always fasten the outside covering of the connection cable with the cable clamp. (If the insulator is chafed, electric leakage may occur.)

Securely install the electrical box cover on the unit. An improperly installed electrical box cover can cause serious accidents such as electric shock or fire through exposure to dust or water.

Install sleeves into any holes made in the walls for wiring. Otherwise, a short circuit could result.

Install a earth (ground) leakage breaker. In addition, install the earth (ground) leakage breaker so that the entire AC main power supply is cut off at the same time. Otherwise, electric shock or fire could result.

Always connect the earth (ground) wire. Improper earthing (grounding) work can cause electric shocks.

Install the remote controller cable and bus wire so as not to be direct touched with your hand.

- (1) Use ring terminals with insulating sleeves as shown in the figure below to connect to the terminal block.
- (2) Securely clamp the ring terminals to the wires using an appropriate tool so that the wires do not come loose.
- (3) Use the specified wires, connect them securely, and fasten them so that there is no stress placed on the terminals.
- (4) Use an appropriate screwdriver to tighten the terminal screws. Do not use a screwdriver that is too small, otherwise, the screw heads may be damaged and prevent the screws from being properly tightened.
- (5) Do not tighten the terminal screws too much, otherwise, the screws may break.
- (6) See the table 1 for the terminal screw tightening torques.

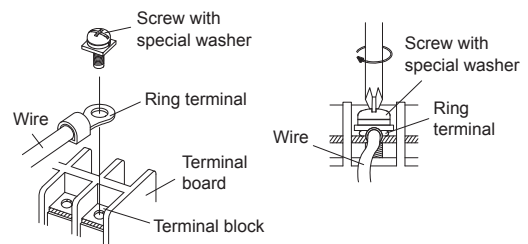
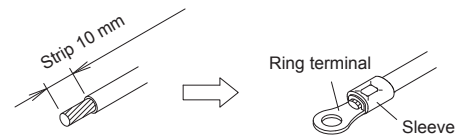

Table 1

Tightening torque	
M4 screw	1.2 to 1.8 N·m (12 to 18 kgf·cm)

WARNING

Use ring terminals and tighten the terminal screws to the specified torques, otherwise, abnormal overheating may be produced and possibly cause heavy damage inside the unit.

6.1. Wiring system diagram

Connection diagrams

Standard pair

Connection cable

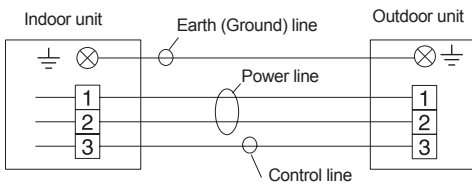

Wired remote controller cable

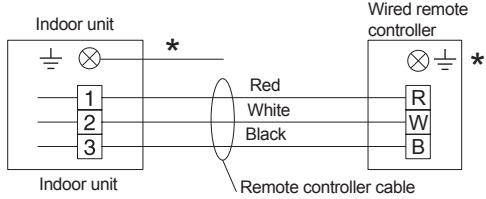

*Earth (Ground) the remote controller if it has a earth (ground) line.

Flexible multi

Connection cable

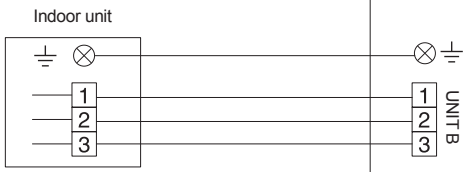
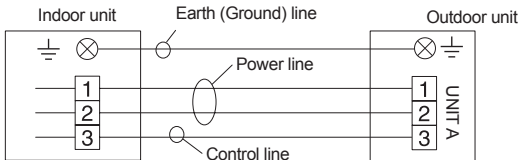

Wired remote controller cable

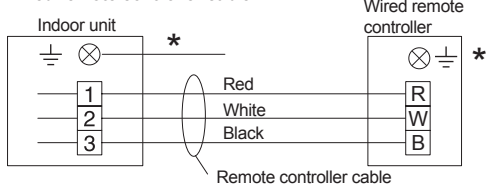

*Earth (Ground) the remote controller if it has a earth ground) line.

Flexible multi (branch box)

Connection cable

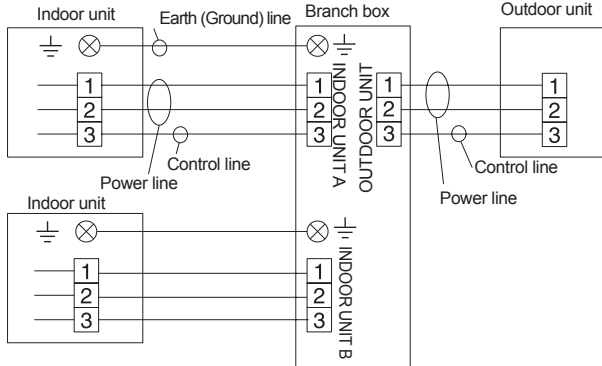

Wired remote controller cable

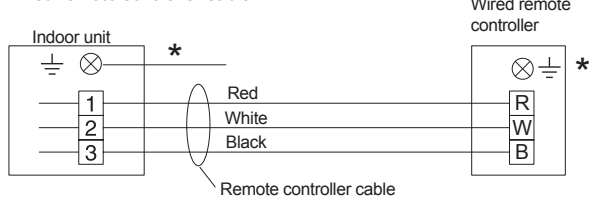

*Earth (Ground) the remote controller if it has a earth ground) line.

Simultaneous twin (18, 22, 24 model only)

Connection cable

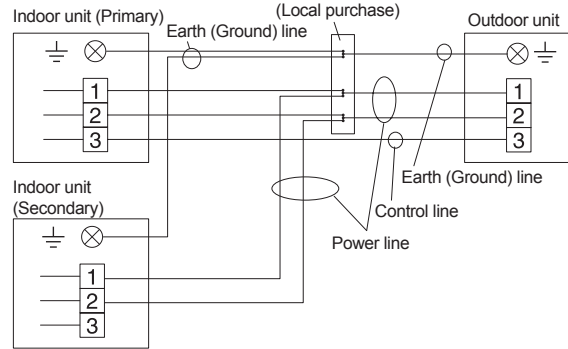

Wired remote controller cable

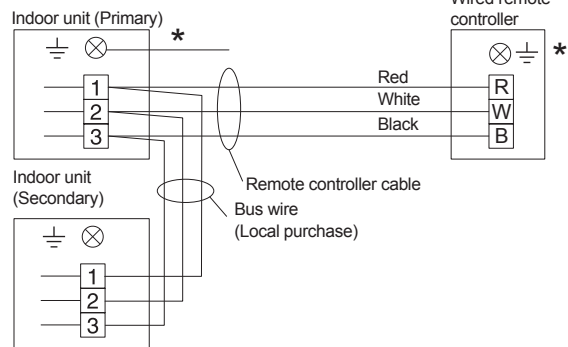

*Earth (Ground) the remote controller if it has a earth (ground) line.

• Connect the remote controller wires to the primary unit.

Simultaneous triple (18 model only)

Connection cable

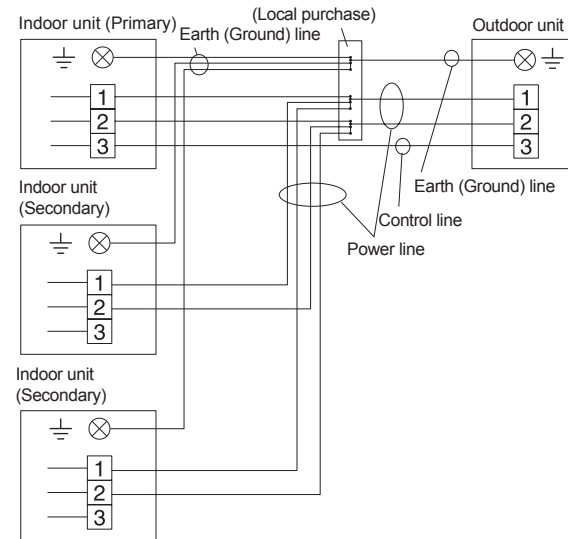

Wired remote controller cable

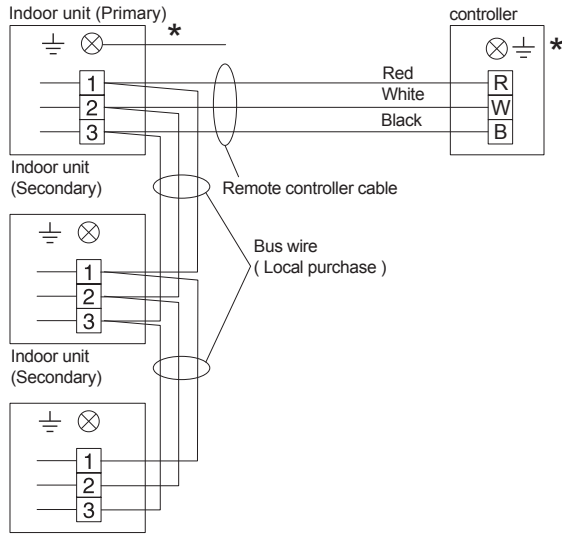

*Earth (Ground) the remote controller if it has an earth (ground) line.

- Connect the remote controller wires to the primary unit.
- Wired remote controller is recommended using simultaneous twin or triple connection.

CAUTION

Tighten the indoor unit connection cable and power supply indoor and outdoor unit, branch box terminal board connections firmly with the terminal board screws. Faulty connection may cause a fire.

If the indoor unit connection cable and power supply are wired incorrectly, the air conditioner may be damaged.

Connect the indoor unit connection cable by matching the numbers of the outdoor, branch box and indoor units terminal board numbers as shown in terminal label.

Earth (Ground) both the indoor and outdoor, branch box units by attaching an earth (ground) cable.

Unit shall be earthed (grounded) in compliance with the applicable local and national cables.

Be sure to refer to the above diagram for do correct field wiring. Wrong wiring causes mal-function of the unit.

Check local electrical rules and also any specific wiring instructions or limitation.

6.2. Connection cable preparation

Keep the earth (ground) wire longer than the other wires.

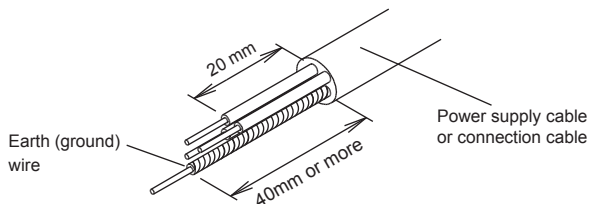

- Use a 4-core wire cable.

6.3. Connection of wiring

- (1) Remove the control box cover and install each connection wire.

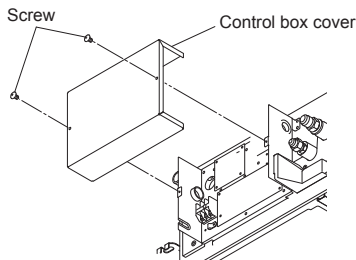

- (2) After wiring is complete, secure the remote controller cable and connection cable with the attached cable-tie and the clammer.

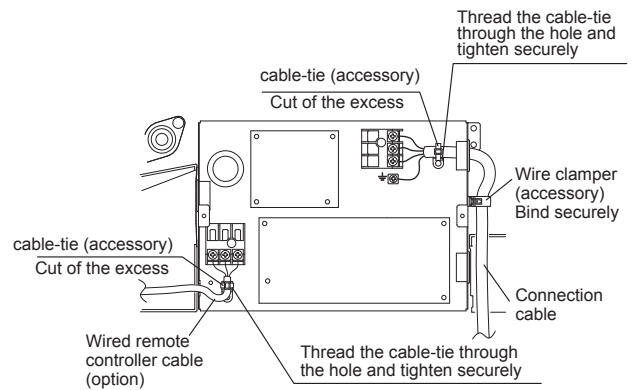
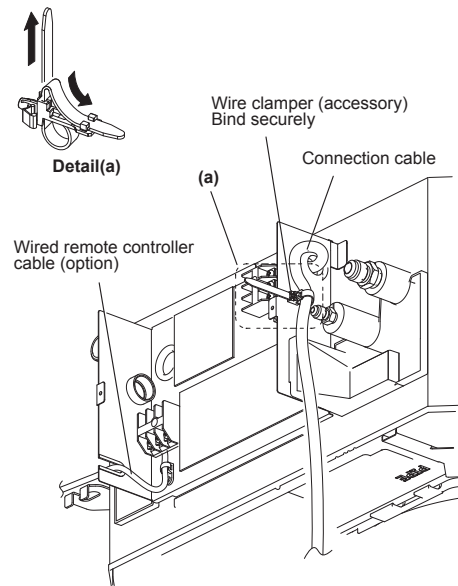

- (3) Install control box cover.

CAUTION

Do not wire the remote controller cable together with or parallel to the connection cables, and power supply cables of the INDOOR UNIT and OUTDOOR UNIT, BRANCH BOX. It may cause erroneous operation.

7. REMOTE CONTROLLER SETTING

Refer to the installation manual enclosed with the remote controller when the wired remote controller (option) is used.

7.1. Load batteries (R03/LR03 × 2)

CAUTION

Take care to prevent infants from accidentally swallowing batteries.

When not using the Remote Controller for an extended period, remove the batteries to avoid possible leakage and damage to the unit.

If leaking battery fluid comes in contact with your skin, eyes, or mouth, immediately wash with copious amounts of water, and consult your physician.

Dead batteries should be removed immediately and disposed of properly, either in a battery collection receptacle or to the appropriate authority.

Do not attempt to recharge dry batteries.

- Press and slide the battery compartment lid on the reverse side to open it. Slide in the direction of the arrow while pressing the  mark.
- Insert batteries.
Be sure to align the battery polarities (+) (-) correctly.
- Close the battery compartment lid.

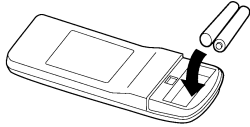

NOTES:

- Never mix new and used batteries, or batteries of different types.
- Batteries should last about 1 year under normal use. If the Remote Controller's operating range becomes appreciably reduced, replace the batteries and press the RESET button with the tip of a ballpoint pen or other small object.

7.2. Installing the remote controller holder

CAUTION

Check that the indoor unit correctly receives the signal from the remote controller, then install the remote controller holder.

Select the remote controller holder selection site by paying careful attention to the following: Avoid places in direct sunlight. Select a place that will not be affected by the heat from a stove, etc.

- Install the remote controller with a distance of 7 m between the remote controller and the photocell as the criteria. However, when installing the remote controller, check that it operates positively.
- Install the remote controller holder to a wall, pillar, etc., with the tapping screw.

- Mount the holder.

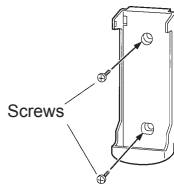

- Set the remote controller.

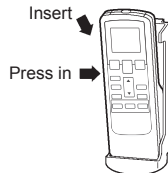

- To remove the remote controller (when use at hand).

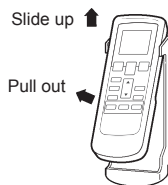

8. CASSETTE GRILLE INSTALLATION

- Installation according to the Installation instruction sheet Cassette grille.
- Be sure to confirm there is no gap between the panel and main unit after installing the Cassette grille.

8.1. Remove the intake grille

- Slide the 2 grille hooks.

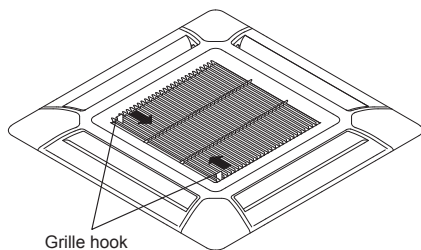

- Open the intake grille and remove.

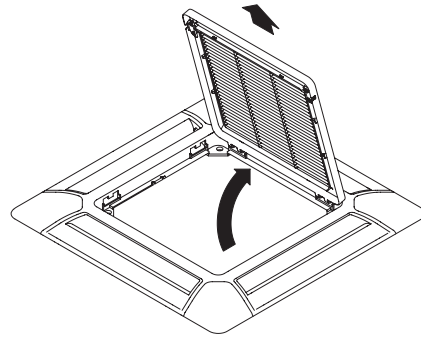

8.2. Installing the panel to indoor unit

- Install the cassette grille on the indoor unit.

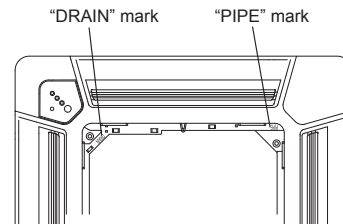

- Align the stamped marks on the cassette grille to the pipe and the drain of the indoor unit.

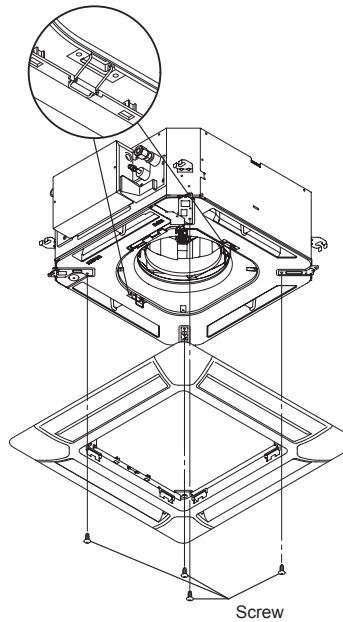

CAUTION

Use only the supplied screws to install the cassette grille.

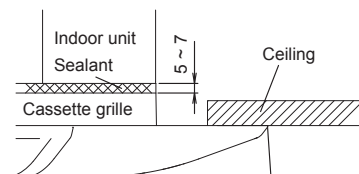

No gap between ceiling and cassette grille around entire perimeter

(2) Connect the connector.

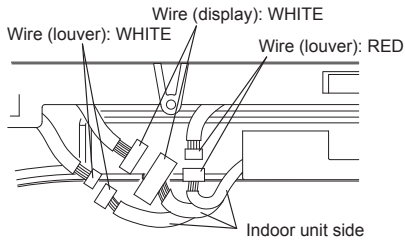

• Arrange the wires as illustrated below.

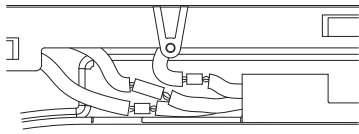

(3) Attach the connector cover.

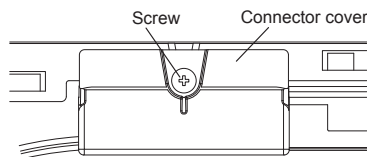

8.3. Attach the intake grille

The installation is the reverse of "REMOVING THE INTAKE GRILLE".

The intake grille can be rotated and installed 4 ways to suit the user's preference.

CAUTION

The louver angle cannot be changed if the power is not on. (If moved by hand, it may be damaged.)

The grille assembly is directionally relative to the air conditioner body.

Install so that there is no gap between the grille assembly and the air conditioner body.

The cassette grille equips with an accessory to prevent the grill completely open. Be sure to read the INSTALLATION SHEET included with the cassette grille before installation.

9. FUNCTION SETTING

CAUTION

Confirm whether the wiring work for outdoor unit has been finished.

Confirm whether the cap for electric control box on the outdoor unit is close.

- This procedure changes to the function settings used to control the indoor unit according to the installation conditions. Incorrect settings can cause the indoor unit malfunction.
- After the power is turned on, perform the "FUNCTION SETTING" according to the installation conditions using the remote controller.
- The settings may be selected between the following two: Function Number or Setting Value.
- Settings will not be changed if invalid numbers or setting values are selected.
- Refer to the installation manual enclosed with the remote controller when the wired remote controller (option) is used.

9.1. Operation method

- While pressing the "FAN" button and "SET TEMP. (▲)" simultaneously, press the "RESET" button to enter the function setting mode.

STEP 1

Remote controller custom code setting

Use the following steps to select the custom code of the remote controller.

(Note that the air conditioner cannot receive a signal if the air conditioner has not been set for the matching custom code.)

The custom codes that are set through this process are applicable only to the signals in the FUNCTION SETTING. For details on how to set the custom codes through the normal process, refer to 9.3. Remote controller custom code setting.

- (1) Press the "SET TEMP. (▲) (▼)" button to change the custom code between



Match the code on the display to the air conditioner custom code. (initially set to **A**) (If the custom code does not need to be selected, press the "MODE" button and proceed to STEP 2.)

- (2) Press the "TIMER MODE" button and check that the indoor unit can receive signals at the displayed custom code.

(3) Press the "MODE" button to accept the custom code, and proceed to STEP 2.

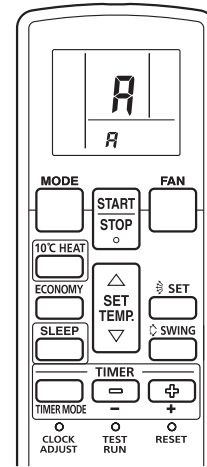

The air conditioner custom code is factory-set to A.

STEP 2

Selecting the Function number and Setting value

- (1) Press the "SET TEMP. (▲) (▼)" buttons to select the function number. (Press the "MODE" button to switch between the left and right digits.)
- (2) Press the "FAN" button to proceed to setting the value. (Press the "FAN" button again to return to the function number selection.)
- (3) Press the "SET TEMP. (▲) (▼)" buttons to select the setting value. (Press the "MODE" button to switch between the left and right digits.)
- (4) Press the "TIMER MODE" button, and "START/STOP" button, in the order listed to confirm the settings.
- (5) Press the "RESET" button to cancel the function setting mode.
- (6) After completing the FUNCTION SETTING, be sure to turn off the power and turn it on again.

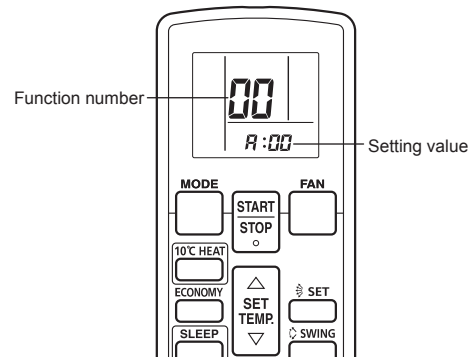

CAUTION

After turning off the power, wait 30 seconds or more before turning it on again. The FUNCTION SETTING doesn't become effective if it doesn't do so.

9.2. Function setting

• Function Details

(1) Filter sign

Select appropriate intervals for displaying the filter sign on the indoor unit according to the estimated amount of dust in the air of the room.

If the indication is not required, select "No indication" (03).

(◆... Factory setting)

Function number	Setting value	Setting description
11	00	Standard (2,500 hours)
	01	Long interval (4,400 hours)
	02	Short interval (1,250 hours)
	03	No indication

(2) Ceiling height

Select the appropriate ceiling height according to the place of installation.

(◆... Factory setting)

Function number	Setting value	Setting description
20	00	Standard (2.7m)
	01	High ceiling (3.0m)

In case of Cassette type models:

The ceiling height values are for the 4-way outlet.

Do not change this setting in the 3-way outlet mode.

7000, 9000 Btu/h models cannot be installed in high ceilings.

Do not change this setting.

(3) Outlet directions

Select the appropriate number of outlet directions according to the installation conditions.
(◆... Factory setting)

Function number	Setting value	Setting description
22	00	4-way
	01	3-way

(4) Room temperature sensor control for cooling

Depending on the installed environment, correction of the room temperature sensor may be required.

Select the appropriate control setting according to the installed environment.
(◆... Factory setting)

Function number	Setting value	Setting description
30	00	Standard
	01	Slightly lower control
	02	Lower control
	03	Higher control

(5) Room temperature sensor control for heating

Depending on the installed environment, correction of the room temperature sensor may be required.

Select the appropriate control setting according to the installed environment.
(◆... Factory setting)

Function number	Setting value	Setting description
31	00	Standard
	01	Lower control
	02	Slightly higher control
	03	Higher control

(6) Auto restart

Enable or disable automatic restart after a power interruption.

(◆... Factory setting)

Function number	Setting value	Setting description
40	00	Enable
	01	Disable

* Auto restart is an emergency function such as for power outage etc. Do not attempt to use this function in normal operation. Be sure to operate the unit by remote controller or external device.

(7) Room temperature sensor switching

(Only for Wired remote controller)

When using the Wired remote controller temperature sensor, change the setting to "Both" (01).

(◆... Factory setting)

Function number	Setting value	Setting description
42	00	Indoor unit
	01	Both

00: Sensor on the indoor unit is active.

01: Sensors on both indoor unit and wired remote controller are active.

* Remote controller sensor must be turned on by using the remote controller

(8) Remote controller custom code

(Only for wireless remote controller)

The indoor unit custom code can be changed.

Select the appropriate custom code.

(◆... Factory setting)

Function number	Setting value	Setting description
44	00	A
	01	B
	02	C
	03	D

(9) External input control

"Operation/Stop" mode or "Forced stop" mode can be selected.

(◆... Factory setting)

Function number	Setting value	Setting description
46	00	Operation/Stop mode
	01	(Setting forbidden)
	02	Forced stop mode

Setting record

- Record any changes to the settings in the following table.

Setting	Setting Value
(1) Filter sign	
(2) Ceiling height	
(3) Outlet directions	
(4) Vertical airflow direction range control	
(5) Room temperature sensor control for cooling	
(6) Room temperature sensor control for heating	
(7) Auto restart	
(8) Room temperature sensor switching	
(9) Remote controller custom code	
(10) External input control	

After completing the FUNCTION SETTING, be sure to turn off the power and turn it on again.

9.3. Remote controller custom code setting

When two or more air conditioners are installed in a room and the remote controller is operating an air conditioner other than the one you wish to set, change the custom code of the remote controller to operate only the air conditioner you wish to set (4 selections possible).

When two or more air conditioners are installed in a room, please contact your retailer to set the individual air conditioner custom codes.

Remote controller custom code setting

Use the following steps to select the custom code of the remote controller. (Note that the air conditioner cannot receive a signal if the air conditioner has not been set for the matching custom code.)

- Press the "START/STOP" button until only the clock is displayed on the remote controller display.
- Press the "MODE" button for at least 5 seconds to display the current custom code (initially set to **A**).
- Press the "SET TEMP. (▲) (▼)" button to change the custom code between **A** → **b** → **c** → **d**. Match the code on the display to the air conditioner custom code.
- Press the "MODE" button again to return to the clock display. The custom code will be changed.

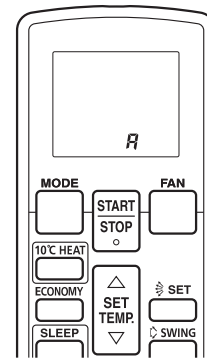

- If no buttons are pressed within 30 seconds after the custom code is displayed, the system returns to the original clock display. In this case, start again from step 1.
 - Depending on the remote controller, the custom code may return to custom code A when the batteries are replaced. In this case, if you use a code other than A, reset the code after replacing the batteries.
- If you do not know the air conditioner custom code setting, try each code (**A** → **b** → **c** → **d**) until you find the code which operates the air conditioner.

9.4. Special installation methods

CAUTION

When setting DIP switches, do not touch any other parts on the circuit board directly with your bare hands.

Be sure to turn off the main power.

9.4.1. Simultaneous multi-system operation

- By combining with an outdoor unit, 2 units for twin and 3 units for triple indoor units, can be switched ON/OFF simultaneously.

(1) Wiring method

- Refer to 6. ELECTRICAL WIRING for wiring procedure and wiring method.
- The indoor unit is connected to the outdoor unit using a connection cable as "primary".
- Connect the remote controller wire to the primary unit.

Twin type (18, 22, 24 model only)

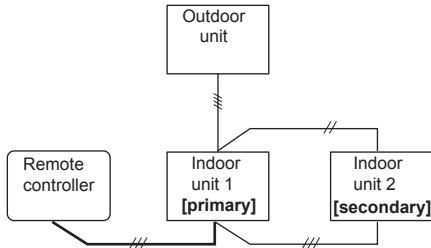

Triple type (18 model only)

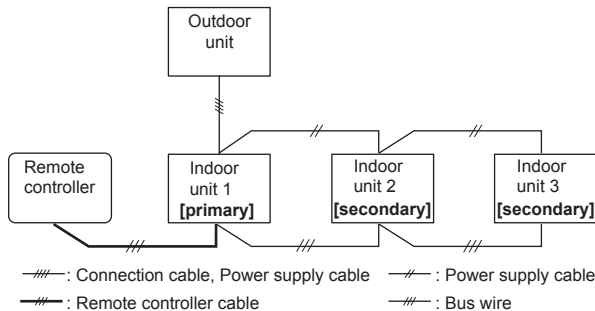

(2) R.C. address setting (DIP switch setting)

Set the R.C. address of each indoor unit using the DIP switches on the indoor unit circuit board. (See the following table and figure.)
The DIP switches are normally set to make the R.C. address "00".

Indoor unit	R.C. address	DIP SWITCH No.			
		1	2	3	4
1	00	OFF	OFF	OFF	OFF
2	01	ON	OFF	OFF	OFF
3	02	OFF	ON	OFF	OFF

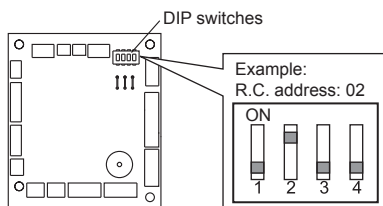

Circuit board in the control box of indoor unit.

NOTES:

Be sure to set the R.C. address sequentially.

(3) Set the primary and secondary (Remote controller setting)

- Turn on all of the indoor units.
- Set the "primary" and "secondary" settings.
(Set the indoor unit that is connected to the outdoor unit using a connection cable as the "primary".)

Function number	Setting value	Setting description
51	00	Primary
	01	Secondary

- After completing the function settings, turn off all of the indoor units, and then turn them back on.

* If error code 21, 22, 24 or 27 is displayed, there may be an incorrect setting. Perform the remote controller setting again.

Twin type (18, 22, 24 model only)

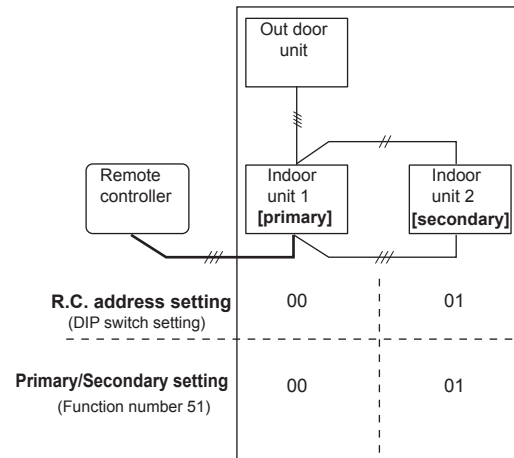

Triple type (18 model only)

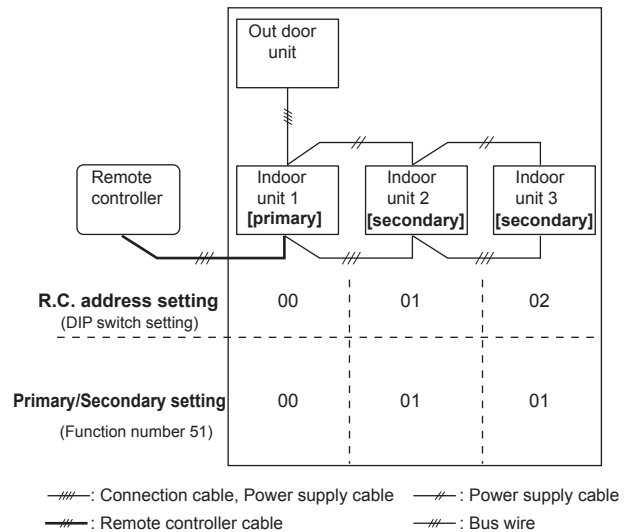

9.4.2. Group control system

A number of indoor units can be operated at the same time using a single remote controller.

(1) Wiring method (indoor unit to remote controller)

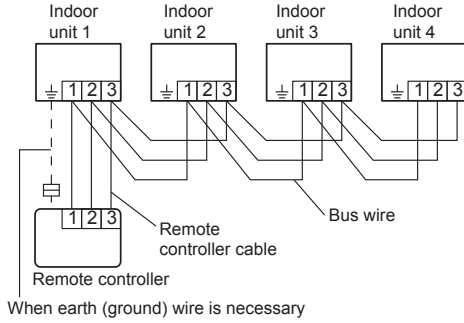

(2) R.C. address setting (DIP switch setting)

Set the R.C. address of each indoor unit using the DIP switches on the indoor unit circuit board. (See the following table and figure.)
The DIP switches are normally set to make the R.C. address "00".

Indoor unit	R.C. address	DIP SWITCH No.			
		1	2	3	4
1	00	OFF	OFF	OFF	OFF
2	01	ON	OFF	OFF	OFF
3	02	OFF	ON	OFF	OFF
4	03	ON	ON	OFF	OFF
5	04	OFF	OFF	ON	OFF
6	05	ON	OFF	ON	OFF
7	06	OFF	ON	ON	OFF
8	07	ON	ON	ON	OFF
9	08	OFF	OFF	OFF	ON
10	09	ON	OFF	OFF	ON
11	10	OFF	ON	OFF	ON
12	11	ON	ON	OFF	ON
13	12	OFF	OFF	ON	ON
14	13	ON	OFF	ON	ON
15	14	OFF	ON	ON	ON
16	15	ON	ON	ON	ON

NOTES:

Be sure to set the R.C. address sequentially.

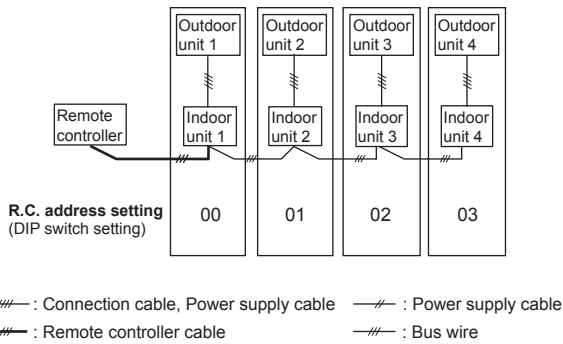

Settings when simultaneous Multi is included

(3) Remote controller setting

1. Turn on all of the indoor units.

* Turn on the indoor unit with the R.C. address "00" last.
(Within 1 minute)

2. Set the refrigerant circuit address.

Assign the same number to all of the indoor units connected to an outdoor unit.
(The unit is factory-set to "00")

Function number	Setting value	Setting description
02	00 ~ 15	Refrigerant circuit address 00 ~ 15

3. Set the "Primary" and "Secondary" settings.

(Set the indoor unit that is connected to the outdoor unit using a connection cable as the "Primary".)

Function number	Setting value	Setting description
51	00	Primary
	01	Secondary

4. After completing the function settings, turn off all of the indoor units, and then turn them back on.

* If error code 21, 22, 24, or 27 is displayed, there may be an incorrect setting. Perform the remote controller setting again.

NOTES:

- When different indoor unit models are connected using the group control system, some functions may no longer be available.
- If the group control system contains multiple units that are operated simultaneously, connect and set the units as shown below.
- Auto-changeover operates under the same mode with model R.C. address "00".
- It should not be connected to any other Gr that is not of the same series (A**G only).

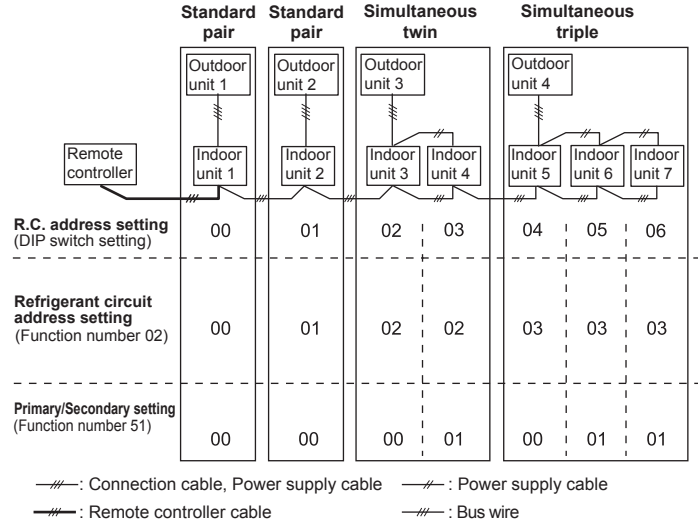

9.4.3. Dual remote controllers

- 2 separate remote controllers can be used to operate the indoor units.
- The timer and self-diagnosis functions cannot be used on the secondary unit of remote controller.

(1) Wiring method (indoor unit to remote controller)

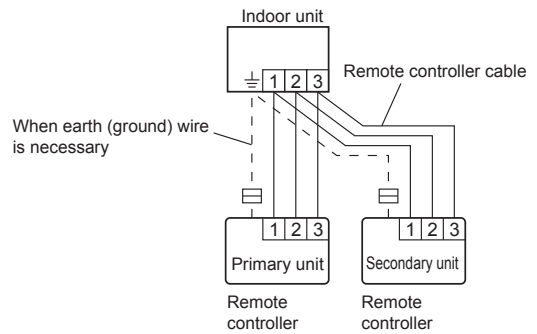

(2) Remote controller DIP switch 1 setting

Set the remote controller DIP switch 1-No. 2 according to the following table.

	DIP SW 1-No. 2
Primary unit	OFF
Secondary unit	ON

10. TEST RUN

Check items

- (1) Is operation of each button on the remote control unit normal?
- (2) Does each lamp light normally?
- (3) Do airflow direction louvers operate normally?
- (4) Is the drain normal?
- (5) Do not have an abnormal noise and vibration during operation?

Do not operate the air conditioner in test run for a long time.

[Operation method]

Depending on your installation, choose from the following:

By the wireless remote controller (with "TEST RUN" button)

- To start test run, press the "START/STOP" button and the "TEST RUN" button on the remote controller.
- To end test run, press the remote controller "START/STOP" button.

By the indoor unit or IR receiver unit

- To start test run, press the "MANUAL AUTO" button of the unit for more than 10 seconds (forced cooling).
- To end test run, press the "MANUAL AUTO" button for more than 3 seconds or press the remote controller "START/STOP" button.

By the wired remote controller

- For the operation method, refer to the installation manual and the operating manual of the wired remote controller.

The Operation indicator lamp and Timer indicator lamp will simultaneously flash during the test run mode.

Heating test run will begin in a few minutes when HEAT is selected by the remote controller [reverse cycle model only].

11. CHECK LIST

Pay special attention to the check items below when installing the indoor unit(s). After installation is complete, be sure to check the following check items again.

CHECK ITEMS	If not performed correctly	CHECK BOX
Has the indoor unit been installed correctly?	Vibration, noise, indoor unit may drop	
Has there been a check for gas leaks (refrigerant pipes)?	No cooling, No heating	
Has heat insulation work been completed?	Water leakage	
Does water drain easily from the indoor units?	Water leakage	
Are the wires and pipes all connected completely?	No operation, heat or burn damage	
Is the connection cable the specified thickness?	No operation, heat or burn damage	
Are the inlets and outlets free of any obstacles?	No cooling, No heating	
After installation is completed, has the proper operation and handling been explained to the user?		

12. OPTIONAL KIT INSTALLATION (OPTION)

⚠ WARNING

Regulation of cable differs from each locality, refer in accordance with local rules.

This air conditioner can be connected with the following optional kits.

Option type	Connector No.
Fresh air intake	CN6
External input	CN102
External output	CN103
Wired Remote Controller	—

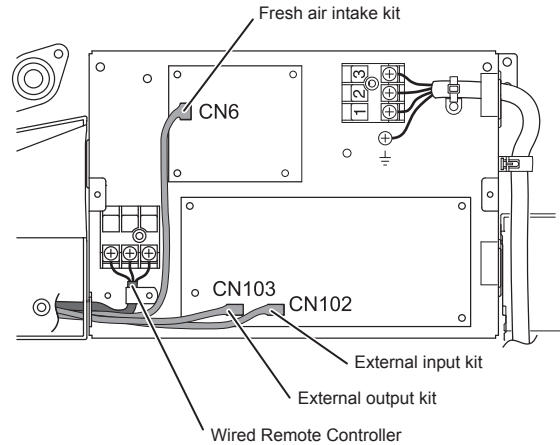

13. CUSTOMER GUIDANCE

Explain the following to the customer in accordance with the operating manual:

- (1) Starting and stopping method, operation switching, temperature adjustment, timer, air flow switching, and other remote controller unit operations.
- (2) Air filter removal and cleaning, and how to use the air louvers.
- (3) Give the operating and Installation Manuals to the customer.
- (4) If the custom code is changed, explain to the customer how it changed (the system returns to custom code A when the batteries in the remote controller unit are replaced).

* (4) is applicable to using wireless remote controller.

14. ERROR CODES

If you use a wireless remote controller, the lamp on the photo detector unit will output error codes by way of blinking patterns. If you use a wired remote controller, error codes will appear on the remote controller display. See the lamp blinking patterns and error codes in the table. An error display is displayed only during operation.

Error display			Wired remote controller Error code	Description
OPERATION lamp (green)	TIMER lamp (orange)	ECONOMY lamp (green)		
●(1)	●(1)	◇	11	Serial communication error
●(1)	●(2)	◇	12	Wired remote controller communication error
●(1)	●(5)	◇	15	Check run unfinished
●(1)	●(6)	◇	16	Peripheral unit connection PCB connection error
●(1)	●(8)	◇	18	External communication error
●(2)	●(1)	◇	21	R.C. address or Refrigerant circuit address setting error [Simultaneous Multi]
●(2)	●(2)	◇	22	Indoor unit capacity error
●(2)	●(3)	◇	23	Combination error

●(2)	●(4)	◇	24	• Connection R.C. address error (indoor secondary unit) [Simultaneous Multi] • Connection R.C. address error (indoor unit or branch unit) [Flexible Multi]
●(2)	●(6)	◇	26	Indoor unit address setting error
●(2)	●(7)	◇	27	Primary unit, secondary unit set-up error [Simultaneous Multi]
●(2)	●(9)	◇	29	Connection R.C. address error in wired remote controller system
●(3)	●(1)	◇	31	Power supply interruption error
●(3)	●(2)	◇	32	Indoor unit PCB model information error
●(3)	●(3)	◇	33	Indoor unit motor electricity consumption detection error
●(3)	●(5)	◇	35	Manual auto switch error
●(3)	●(9)	◇	39	Indoor unit power supply error for fan motor
●(3)	●(10)	◇	3A	Indoor unit communication circuit (wired remote controller) error
●(4)	●(1)	◇	41	Inlet air temp. sensor error
●(4)	●(2)	◇	42	Indoor unit Heat Ex. Middle temp. sensor error
●(4)	●(4)	◇	44	Human sensor error
●(5)	●(1)	◇	51	Indoor unit fan motor error
●(5)	●(3)	◇	53	Drain pump error
●(5)	●(7)	◇	57	Damper error
●(5)	●(15)	◇	5U	Indoor unit error
●(6)	●(1)	◇	61	Outdoor unit reverse/missing phase and wiring error
●(6)	●(2)	◇	62	Outdoor unit main PCB model information error or communication error
●(6)	●(3)	◇	63	Inverter error
●(6)	●(4)	◇	64	Active filter error, PFC circuit error
●(6)	●(5)	◇	65	Trip terminal L error
●(6)	●(8)	◇	68	Outdoor unit rush current limiting resistor temp. rise error
●(6)	●(10)	◇	6A	Display PCB microcomputers communication error
●(7)	●(1)	◇	71	Discharge temp. sensor error
●(7)	●(2)	◇	72	Compressor temp. sensor error
●(7)	●(3)	◇	73	Outdoor unit Heat Ex. liquid temp. sensor error
●(7)	●(4)	◇	74	Outdoor temp. sensor error
●(7)	●(5)	◇	75	Suction Gas temp. sensor error
●(7)	●(6)	◇	76	• 2-way valve temp. sensor error • 3-way valve temp. sensor error
●(7)	●(7)	◇	77	Heat sink temp. sensor error
●(8)	●(2)	◇	82	• Sub-cool Heat Ex. gas inlet temp. sensor error • Sub-cool Heat Ex. gas outlet temp. sensor error

●(8)	●(3)	◇	83	Liquid pipe temp. sensor error
●(8)	●(4)	◇	84	Current sensor error
●(8)	●(6)	◇	86	• Discharge pressure sensor error • Suction pressure sensor error • High pressure switch error
●(9)	●(4)	◇	94	Trip detection
●(9)	●(5)	◇	95	Compressor rotor position detection error (permanent stop)
●(9)	●(7)	◇	97	Outdoor unit fan motor 1 error
●(9)	●(8)	◇	98	Outdoor unit fan motor 2 error
●(9)	●(9)	◇	99	4-way valve error
●(9)	●(10)	◇	9A	Coil (expansion valve) error
●(10)	●(1)	◇	A1	Discharge temp. error
●(10)	●(3)	◇	A3	Compressor temp. error
●(10)	●(4)	◇	A4	High pressure error
●(10)	●(5)	◇	A5	Low pressure error
●(13)	●(2)	◇	J2	Branch boxes error [Flexible Multi]

Display mode ● : 0.5s ON / 0.5s OFF
◇ : 0.1s ON / 0.1s OFF
() : Number of flashing

[Troubleshooting with the indoor unit display]

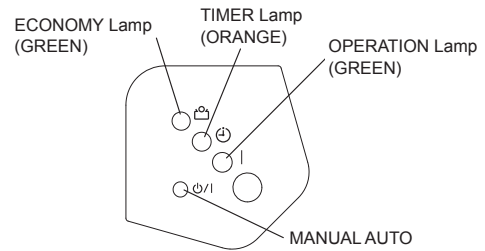

[Troubleshooting at the remote controller LCD]

This is possible only on the wired remote controller.

[Self-diagnosis]

If an error occurs, the following display will be shown. ("Er" will appear in the set room temperature display.)

