

# AIR CONDITIONER OPTIONAL PARTS CASSETTE GRILLE

  
**PART No. 9384739001**  
 MADE IN THAILAND  
 [Original instructions]

# INSTALLATION MANUAL

For authorized service personnel only.

## UTG-UN\*A-W UTG-UN\*B-W

### 1. SAFETY PRECAUTIONS

**WARNING** Indicates a potentially or imminently hazardous situation which, if not avoided, could result in death or serious injury.

For the air conditioner to operate satisfactorily, install as outlined in this manual.

Do not turn on the power until all installation work is complete.

Never touch electrical components immediately after the power supply has been turned off. Electric shock may occur. After turning off the power, always wait 5 minutes or more before touching electrical components.

**CAUTION** Indicates a potentially hazardous situation that may result in minor or moderate injury or damage to property.

The louver angle cannot be changed if the power is not on. (If moved by hand, it may be damaged.)

Installation must be done by two people.





Please refer to the installation manual attached to the indoor unit during installation.

Hand this manual to the customer to keep for future use, such as for maintenance.

Do not suspend very heavy weights from the intake grille.

### 2. ACCESSORIES

The following installation parts are furnished. Use them as required.

| Name and shape   | Q'ty            | Application  |
|--|-----------------|--|
| Installation manual<br>   | 1 (This manual) |  |
| Hexagon screw<br>         | 4               | For mounting grille  |
| Tapping screw (white)<br> | 5               | For fixing the latches of the intake grill<br>• UTG-UN*A-W: use 4<br>• UTG-UN*B-W: use 5 |
| Cable tie (medium)<br>    | 1               | For connection cable binding   |

### 3. INSTALLING THE CASSETTE GRILL

This products is manufactured to metric units and tolerances. United States customary units are provided for reference only. In cases where exact dimensions and tolerances are required, always refer to metric units.

#### 3.1. Installation procedure

- (1) Remove the control box cover and control box bottom cover of the indoor unit.

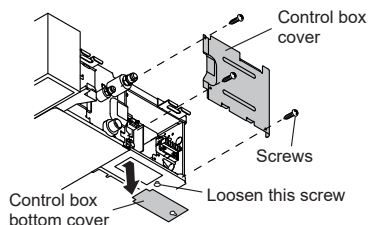

- (2) Release the latches on the intake grille.

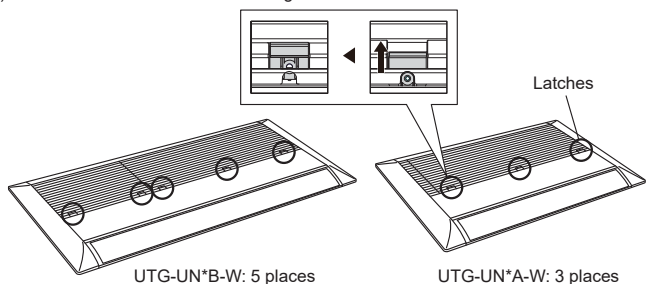

- (3) Open the intake grille. Then while gently lifting the intake grille, release the tabs in order from the edge and remove it.  
Number of tabs, UTG-UN\*A-W: 3, UTG-UN\*B-W: 5

\*The hinges of the intake grille may break if the intake grille is forcefully opened to 120 degrees or more.

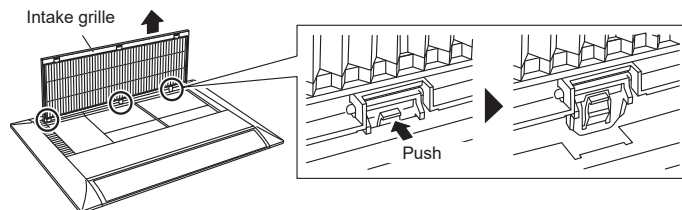

- (4) Remove the decoration panel. (UTG-UN\*A-W only)

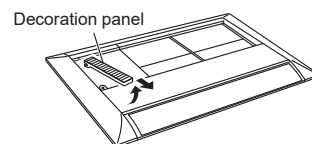

- (5) Remove the fixing screw and the side cover on the both sides.

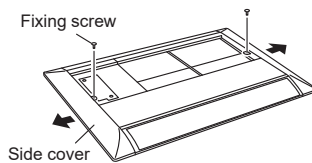

- (6) Attach 2 hexagon screws (accessories) to mounting tabs on left side of the indoor unit only, leaving a gap of 10 to 15 mm (3/8 to 9/16 in).

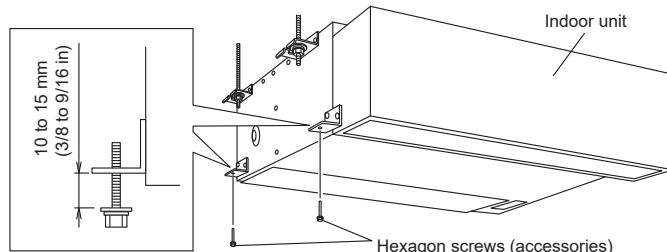

- (7) Remove the 3 screws on the cassette grille to hook the holding wires.

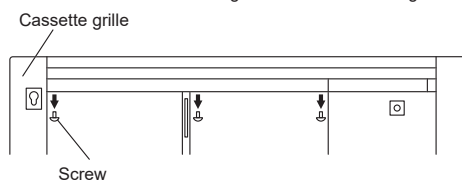

- (8) Thread the 3 screws removed in step (7) through the loop of the holding wires. Then tighten the screws so that you don't damage the holding wires.

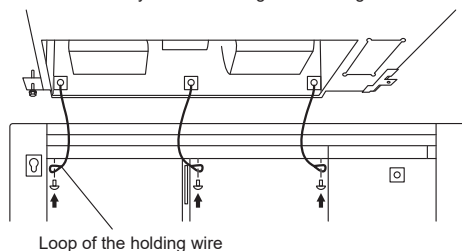

English

Deutsch

Français

Español

Italiano

Ελληνικά

Português

Русский

Türkçe

- (9) Connect the 2 connection cables of Cassette grille to the terminal (CN155 and CN156) on controller PCB in the control box through the cable hole on back of the indoor unit.  
Be sure to match the color of the connector and terminal. Otherwise, the airflow louver will not work properly.

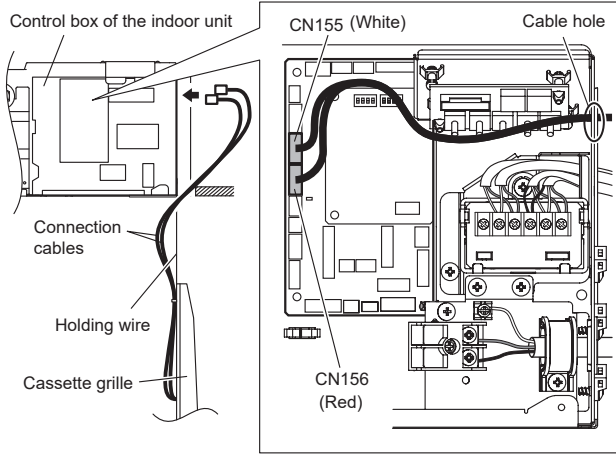

- (10) Reinstall the control box cover of the indoor unit removed in step (1).

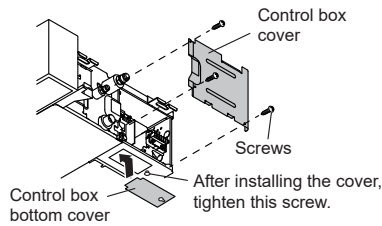

- (11) Bind the cassette grille connection cables and the transmission cable on back side of the indoor unit with the cable tie (medium) (accessories). Do not bind the power supply cable and other cables together.

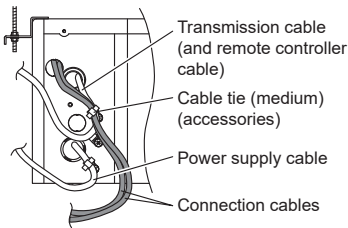

- (12) Hook the 2 keyholes on the left side of the cassette grille through the 2 hexagon screws attached to the indoor unit in step (6).

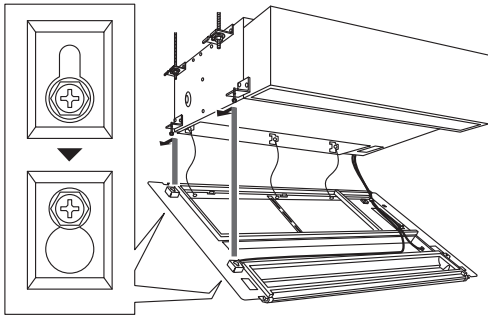

- (13) Hook the hook on the right side of the cassette grill to the square ring of the indoor unit.

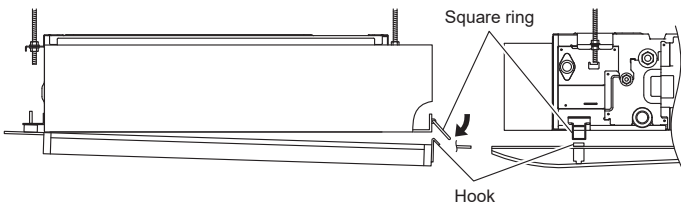

- (14) Loosen the screws (do not remove) and remove the maintenance panel.

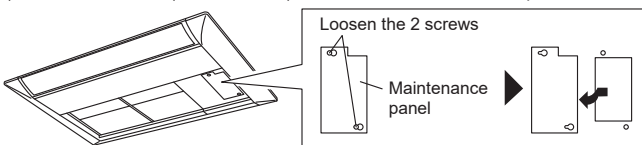

- (15) Look through the maintenance opening to see if any cables interfere with the mount.

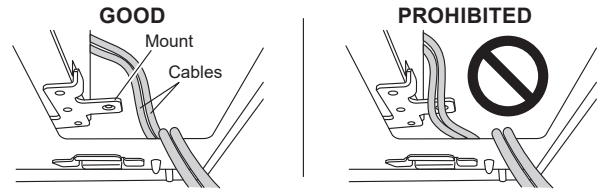

- (16) Attach the 2 hexagon screws (accessories) to the two screw holes on the right side of the cassette grill and light tighten them.  
Do not pinch the connection cables between the screw fixing part of the indoor unit and cassette grill.

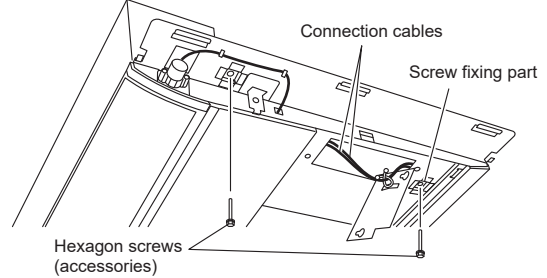

- (17) Tighten the 4 hexagon screws you installed in steps (6) and (16), until the seal material between the Cassette grille and the indoor unit is compressed to a thickness of 5 to 7 mm (3/16 to 1/4 in).

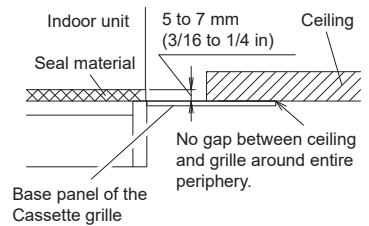

**CAUTION**

- Use only the supplied screws to install the Cassette grille.
- Install so that there is no gap between the grille and the indoor unit.
- If there is a gap, an error will occur as shown in the following figure.

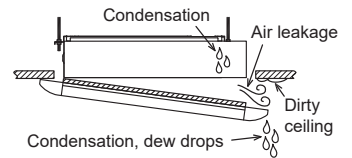

- (18) Reinstall the maintenance panel removed in step (14). Then tighten the 2 screws.

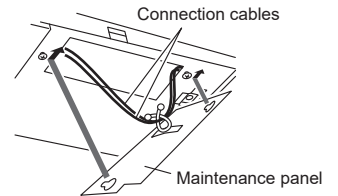

- (19) Reinstall the side covers and screws removed in step (5).

- (20) Reinstall the decoration panel removed in step (4) and fix with the tapping screw (accessories). (UTG-UN\*A-W only)

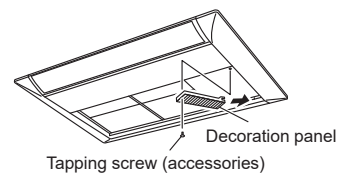

- (21) Insert all the tabs on the intake grille you removed in step (3) into the cassette grill, making sure that the intake grill does not come off.

- (22) Close the intake grill and lock the all latches released in step (2).

- (23) Fix the all latches with the tapping screws (accessories).  
Fixing positions UTG-UN\*A-W: 3 places, UTG-UN\*B-W: 5 places

