

AIR CONDITIONER OPTIONAL PARTS

Branch pipes

PART NO. 9379191005-02



⚠ CAUTION

**R32
REFRIGERANT**

This Air Conditioner contains and operates with refrigerant R32.

THIS PRODUCT MUST ONLY BE INSTALLED OR SERVICED BY QUALIFIED PERSONNEL.

Refer to Commonwealth, State, Territory and local legislation, regulations, codes, installation & operation manuals, before the installation, maintenance and/or service of this product.

⚠ CAUTION

**R410A
REFRIGERANT**

This Air Conditioner contains and operates with refrigerant R410A.

THIS PRODUCT MUST ONLY BE INSTALLED OR SERVICED BY QUALIFIED PERSONNEL.

Refer to Commonwealth, State, Territory and local legislation, regulations, codes, installation & operation manuals, before the installation, maintenance and/or service of this product.

INSTALLATION MANUAL

For authorized service personnel only.

1. SAFETY PRECAUTIONS

⚠ CAUTION

- These branch pipes are to be used for R410A and R32 refrigerant.
- The Installation Manual is intended for branch pipes that are used simultaneously on multi-system.
- Before installation, check the combination of indoor units, outdoor unit, and branch pipes thoroughly.
- Before installation, read the Installation Manual of the indoor and outdoor units carefully.
- The indoor units must be installed in the same room.
- For the acceptable length of the refrigerant pipe and the acceptable difference in height, please refer to the Installation Manual of the outdoor unit.

2. ABOUT THE UNIT

2.1. Parts list

	Gas side		Liquid side		Others
	Gas pipe	Insulation	Liquid pipe	Insulation	
UTP-SX236 □					
UTP-SX254 □					Adapter Ø6.35 Ø9.52 Qty : 2
UTP-SX354 □					Cable tie Qty : 1

2.2. Selection procedure

•For R410

Type	Kit name	Number of kits	Capacity of outdoor unit connected (BTU/h)	Piping diameter kit to outdoor unit (Standard) *1	Piping diameter kit to indoor unit	Number of indoor units
Twin connection	UTP-SX236□	1	36,000	Ø 9.52 (Liquid) Ø 15.88 (Gas)	Ø 6.35 (Liquid) Ø 12.70 (Gas)	2
	UTP-SX254□	1	45,000 54,000	Ø 9.52 (Liquid) Ø 15.88 (Gas)	Ø 9.52 (Liquid) *2 Ø 15.88 (Gas)	2
Triple connection	UTP-SX354□	1	54,000	Ø 9.52 (Liquid) Ø 15.88 (Gas)	Ø 6.35 (Liquid) Ø 12.70 (Gas)	3

•For R32

Type	Kit name	Number of kits	Capacity of outdoor unit connected (BTU/h)	Piping diameter kit to outdoor unit (Standard) *1	Piping diameter kit to indoor unit	Number of indoor units
Twin connection	UTP-SX236□	1	36,000 45,000 54,000	Ø 9.52 (Liquid) Ø 15.88 (Gas)	Ø 6.35 (Liquid) Ø 12.70 (Gas)	2
Triple connection	UTP-SX354□	1	54,000	Ø 9.52 (Liquid) Ø 15.88 (Gas)	Ø 6.35 (Liquid) Ø 12.70 (Gas)	3

*1: For the diameter of the connection piping between the outdoor unit and the branch pipes, please refer to the Installation Manual of the outdoor unit.

*2: When installing UTP-SX254□, it is necessary to install the adapter on the half union at the liquid pipe of the indoor unit.

3. INSTALLATION WORK

⚠ CAUTION

- Do not mistake the direction of connection.
- Set the piping from the branch pipe to the indoor units to be of the same length. (Max. difference: 8m)
- Shorten the length of the piping after branching as much as possible. (Max. length: 20m)

(1) Check the direction of connection.

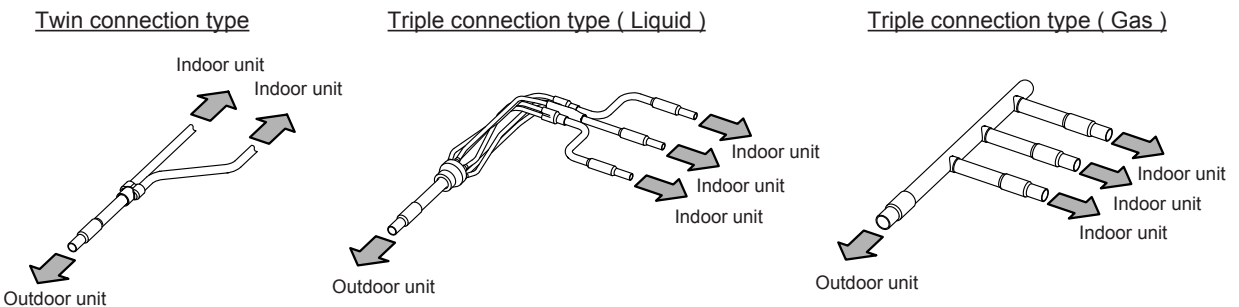

(2) When installing UTP-SX254□, install the adapter on the half union at the liquid pipe of the indoor unit.

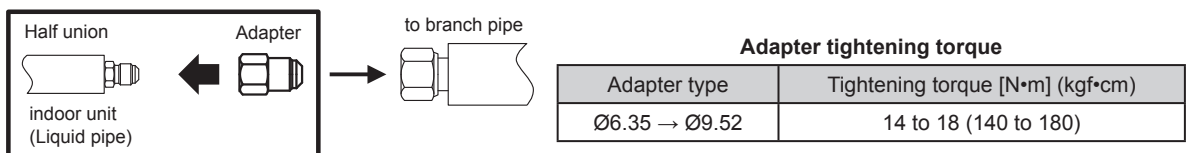

- When using the Adapter, be careful not to overtighten the nut, or the smaller pipe may be damaged.
- Use appropriate wrenches to avoid damaging the connection thread by overtightening the flare nut.
- Apply wrenches on both of flare nut (local part), and Adapter to tighten them.

(3) If the diameter of the connection piping is too large, use a pipe cutter to cut as shown below.

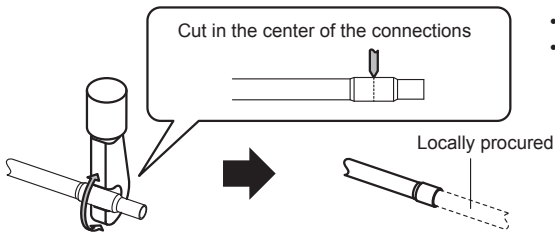

- Always use a pipe cutter.
- After cutting, remove the burr and clean the cut section.

(4) Positioning of branch pipes

- If it is placed horizontally, keep it within $\pm 15^\circ$.
Otherwise, it will not separate the refrigerant evenly, causing a reduction in performance.

Twin connection type

Triple connection type (Liquid)

Triple connection type (Gas)

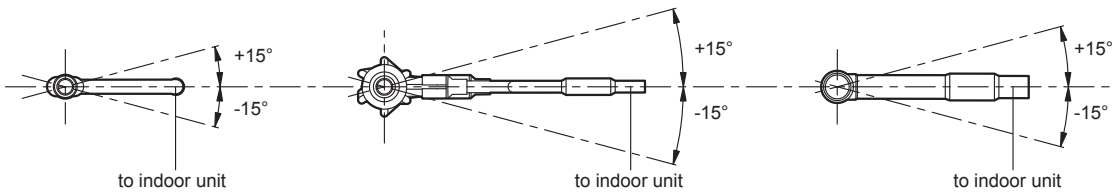

- Place the branch pipe in a horizontal position as far as possible. Only place the branch pipe as shown below during unavoidable circumstances.

Twin connection type

Triple connection type (Liquid)

Triple connection type (Gas)

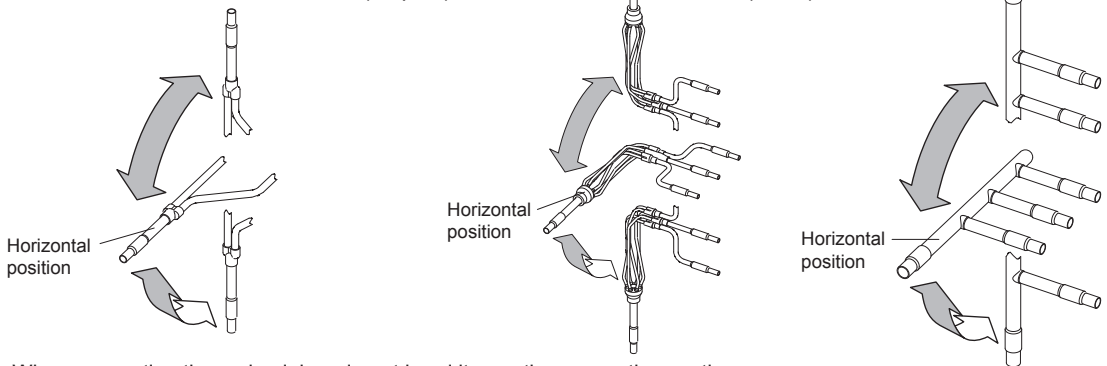

- When connecting the main piping, do not bend it near the connection section.
If the main pipe must be bent due to unavoidable circumstances, ensure that the linear section is 10 times or more than the diameter of the connection piping.

Twin connection type

Triple connection type (Liquid)

Triple connection type (Gas)

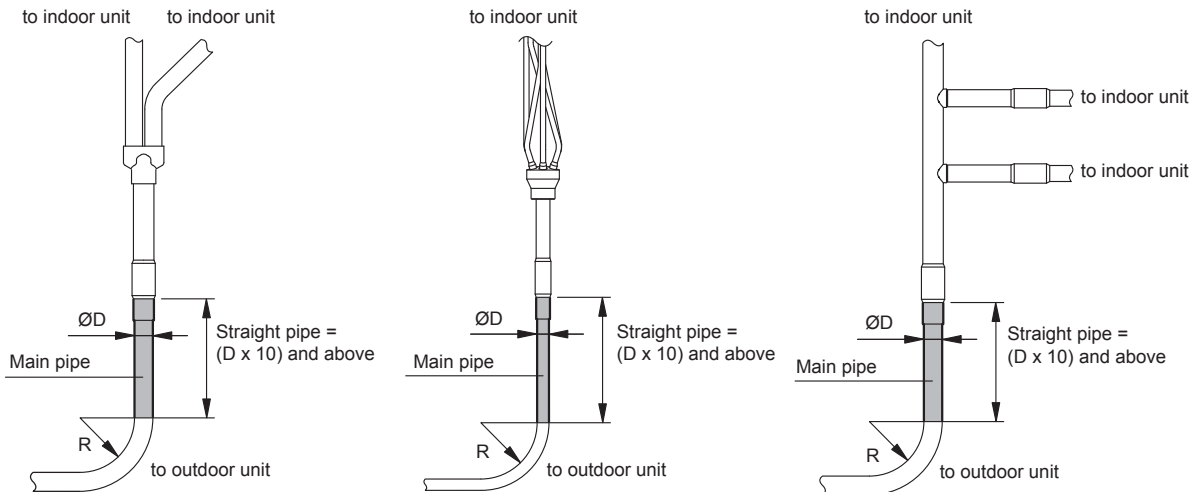

(5) Welding the piping

- Check that the connection piping is securely inserted into the branch pipe before welding.

CAUTION

- During piping work, apply nitrogen gas while brazing the pipes. If pipes are brazed without applying nitrogen gas, it will create a large amount of oxidation film, which will cause a critical malfunction.
- To prevent moisture or foreign matter from entering during work, do not leave the piping open.
- Refer to the Installation Manual supplied with the outdoor unit for sealing test evacuation procedures.

- Do not weld the rubber on the branch pipe. (UTP-SX354□ only)

(6) Installing Cable tie (UTP-SX354□ only)

- Install the Cable tie as shown below.

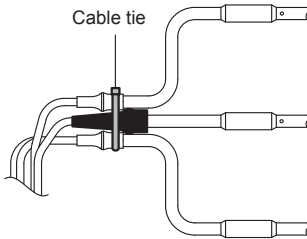

- The installation position of the Cable tie is shown on the left.
- After installing the Cable tie, cut away the excess portion neatly.

(7) After brazing the pipes, use the supplied heat insulation to insulate them.

- Remove the protective sheet from the double-stick tape that is affixed to the heat insulation.

Twin connection type

Triple connection type (Liquid)

Triple connection type (Gas)

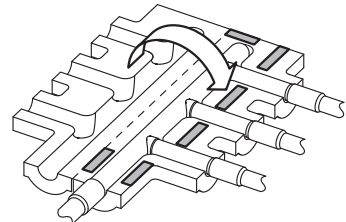
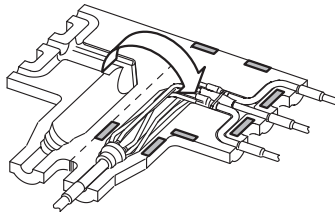
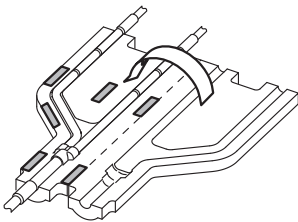

- Use tape (locally procured) to seal the seam so that there will be no gap at the junction between the aforementioned heat insulation and the heat insulation on the local piping.

Twin connection type

Triple connection type (Liquid)

Triple connection type (Gas)

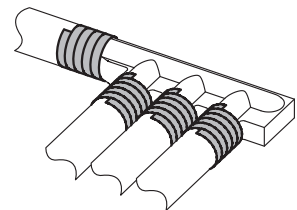
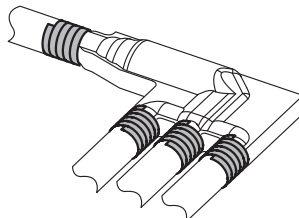
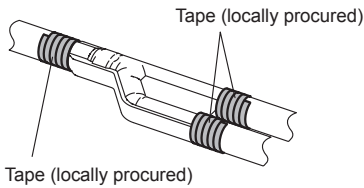

CAUTION

- Be sure to install the heat insulation on liquid pipes and gas pipes. Unless they are thermally insulated, water condensation can cause accidents or reduction in performance.
- After installing the heat insulation, if you worry about possible condensation due to the high humidity of installation position, please use locally procured heat insulation to reinforce insulation.

Twin connection type

Triple connection type (Liquid)

Triple connection type (Gas)

