

REFRIGERANT  
R22,R407C,R410A

(PART NO. 9377782014)

# INSTALLATION INSTRUCTION SHEET

## EV KIT

**For safe installation and trouble-free operation, you must:**

- Carefully read this installation manual before beginning.
- Follow each installation or repair step exactly as shown.
- Observe all local, state and national electrical codes.
- Pay close attention to all danger, warning, and caution notices given in this manual.

<b>WARNING</b>	This mark indicates procedures which, if improperly performed, might lead to the death or serious injury of the user.
<ul style="list-style-type: none"> <li>• Installation and maintenance work must be performed by authorized company or service personnel only.</li> <li>• For the air conditioner to operate satisfactorily, install it as outlined in this installation manual.</li> <li>• Connect the indoor unit, outdoor unit and EV KIT with the air conditioner piping and cords available from our standard parts. This installation manual describes the correct connections using the installation set available from our standard parts.</li> <li>• If refrigerant leaks while work is being carried out, ventilate the area. If the refrigerant comes in contact with a flame, it produces a toxic gas.</li> <li>• Do not supply power to the unit until all wiring and tubing are completed or reconnected and checked.</li> <li>• Highly dangerous electrical voltages are used in this system. Carefully refer to the wiring diagram and these instructions when wiring. Improper connections and inadequate grounding can cause accidental injury or death.</li> </ul>	
<ul style="list-style-type: none"> <li>• <b>After installation, explain correct operation to the customer, using the operating manual.</b></li> <li>• <b>Let the customer keep this installation manual because it is used when the air conditioner is serviced or moved.</b></li> </ul>	







<b>CAUTION</b>	This mark indicates procedures which, if improperly performed, might possibly result in personal harm to the user, or damage to property.								
<ul style="list-style-type: none"> <li>• Never use piping which has been used for previous installation. Only use parts that are delivered with the unit.</li> <li>• Be careful not to scratch the air conditioner when handling it.</li> <li>• Connect all wiring tightly. Loose wiring may cause overheating at connection points and a possible fire hazard.</li> <li>• Touching sharp edges and aluminum fin may cause injury.</li> <li>• If the humidity around refrigerant piping is high, condensation or water leak may occur. Therefore, be sure to carry out heat insulation process of gas and liquid piping. As for the insulating material, refer to the table below and use the material which provides enough heat insulating effect. (Reference) In case a heat insulating material which thermal conductivity is less than 0.045W / mk (at 20 ° C (68 ° F)) is used.</li> </ul>									
<table border="1" style="width: 100%; text-align: center;"> <thead> <tr> <th>Humidity around piping</th> <th>Recommended thickness of heat insulating material</th> </tr> </thead> <tbody> <tr> <td>≤ 70 %</td> <td>10 mm ( 13/32" )</td> </tr> <tr> <td>70 % to 80 %</td> <td>15 mm ( 19/32" )</td> </tr> <tr> <td>80 % ≤</td> <td>20 mm ( 13/16" )</td> </tr> </tbody> </table>		Humidity around piping	Recommended thickness of heat insulating material	≤ 70 %	10 mm ( 13/32" )	70 % to 80 %	15 mm ( 19/32" )	80 % ≤	20 mm ( 13/16" )
Humidity around piping	Recommended thickness of heat insulating material								
≤ 70 %	10 mm ( 13/32" )								
70 % to 80 %	15 mm ( 19/32" )								
80 % ≤	20 mm ( 13/16" )								

Pay careful attention to the following points, when use refrigerant R410A :  
(The basic installation work procedures are the same as conventional refrigerant (R22,R407C) models.)

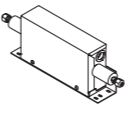
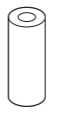
<ul style="list-style-type: none"> <li>• Since the working pressure is 1.6 times higher than that of conventional refrigerant (R22) models, some of the piping and installation and service tools are special. (See the table in the SPECIAL TOOLS FOR R410A section.) Especially, when replacing a conventional refrigerant (other than R410A) model with a new refrigerant R410A model, always replace the conventional piping and flare nuts with the R410A piping and flare nuts.</li> </ul>
<ul style="list-style-type: none"> <li>• Models that use refrigerant R410A have a different charging port thread diameter to prevent erroneous charging with conventional refrigerant (R22, R407C) and for safety. Therefore, check beforehand. [The charging port thread diameter for R410A is 1/2 UNF 20 threads per inch.]</li> </ul>
<ul style="list-style-type: none"> <li>• Be more careful than the installation of the refrigerant (other than R410A) models, not to enter foreign matters (oil, water, etc.) and other refrigerant into the piping. Also, when storing the piping, securely seal the openings by pinching, taping, etc.</li> </ul>
<ul style="list-style-type: none"> <li>• When charging the refrigerant, take into account the slight change in the composition of the gas and liquid phases, and always charge from the liquid phase side whose composition is stable.</li> </ul>

Tool Name	Content of change
Gauge manifold	Pressure is huge and cannot be measured with a conventional gauge. To prevent erroneous mixing of other refrigerants, the diameter of each port has been changed. It is recommended to use a gauge manifold with a high pressure display range of -0.1 to 5.3 MPa (30 in. Hg vac to 800 psi) and a low pressure display range of -0.1 to 3.8 MPa (30 in. Hg vac to 600 psi).
Charging hose	To increase pressure resistance, the hose material and base size were changed.
Vacuum pump	A conventional vacuum pump can be used by installing a vacuum pump adapter.
Gas leakage detector	Special gas leakage detector for HFC refrigerant R410A.

### 1. PARTS INCLUDE

Name and Shape	Q'ty	Name and Shape	Q'ty	Name and Shape	Q'ty	Name and Shape	Q'ty
EV KIT 	1	Coupler heat insulation 	2	Special nut A (M10) (large flange) 	1	Special nut B (M10) (small flange) 	1
Binder 	Large 5 Small 2	Screw 	4	Tube 	1		

### 2. SPECIFICATIONS

#### 2-1. EXTERNAL VIEW

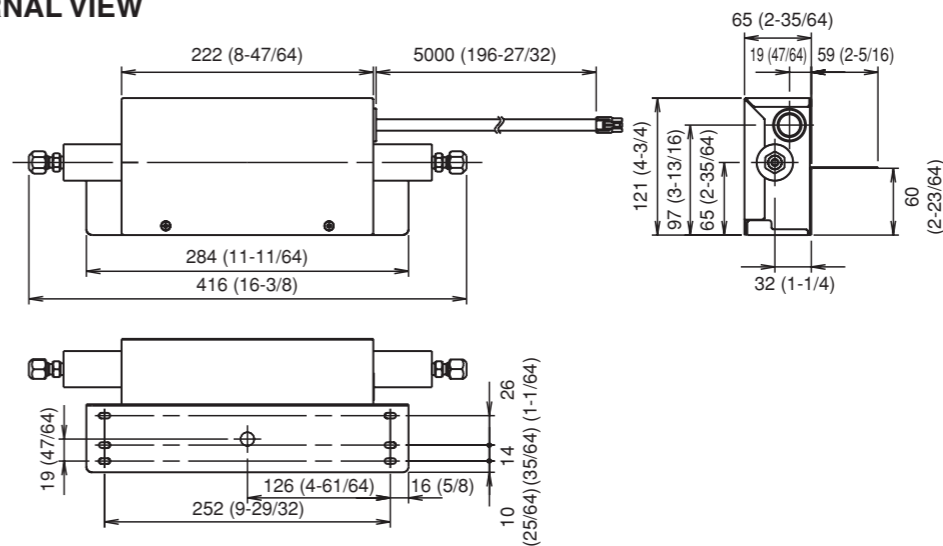

Fig 2-1.

Unit:mm(in.)

#### 2-2. ENVIRONMENT SPECIFICATIONS

Dimension (H×W×D)	121×222×65 mm (4-3/4×8-47/64×2-35/64 in.)		
Weight (Net)	1.5 kg (3.3 lbs)		
Wiring length	5 m (16-25/64 ft)		
Environment	Operating	Temperature	0 to 46 °C (32 to 115 °F)
	Packaged	Temperature	-10 to 60 °C (14 to 140 °F)
		Humidity	10 to 90 %RH (no condensation)

### 3. CONNECTION PIPE REQUIREMENT

Model name	Material	Outside diameter	Wall thickness
UTR-EV09	COPPER TUBE	6.35 mm	0.8 mm
UTR-EV14		1/4"	1/32"

#### SPECIFICATION OF COPPER TUBE

Allowable tensile stress	Design pressure	Material
≥33 N/mm <sup>2</sup> ≥4790 lbf/in <sup>2</sup>	4.2 MPa 610 psi	JIS H3300-C1220T-O or equivalent

## 4. SELECTING THE MOUNTING POSITION

### ⚠ WARNING

- Install at a place that can withstand the weight of the unit and install positively so that the unit will not topple or fall.

### ⚠ CAUTION

- Since noise will emit from EV KIT during the operation of air conditioner, so be sure to install it in ceiling instead of indoor room.
- Be sure to set the service hole on the ceiling.

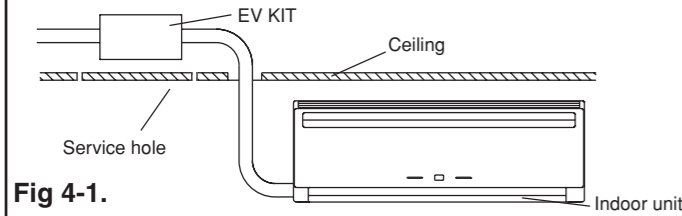

Fig 4-1.

- Do not install the unit in a location with any of the following conditions.
  - Outdoors
  - There is the danger of combustible gas leakage.
  - Near a fireplace or other heating apparatus.
  - There is oily smoke, machine oil (i.e. factory), salty environment with direct sea breeze.
  - There is too much of dust.
  - Corrosive gas such as sulphurous acid gas is generated.
  - Not well-ventilated place not avoiding rains and direct sunlight.
- If children under 10 years old may approach the unit, take preventive measures so that they cannot reach the unit.
- Install the indoor and outdoor units, power wiring, signal wiring and remote control wiring 1 m away from television and radio to avoid distorted images and noise. (However, distorted noise may not be avoidable even if units and wiring mentioned above are installed 1m away from television and radio depending on conditions of electrical waves).

#### Decide the mounting position with the customer as follows:

- (1) Install the unit level on a strong wall, floor, ceiling which is not subject to vibration.
- (2) Install the unit where the connection pipe can be easily installed.
- (3) Take servicing, etc. into consideration and leave the spaces shown in Fig. 4-2.
- (4) Install the unit where vibrations and noise are not amplified.

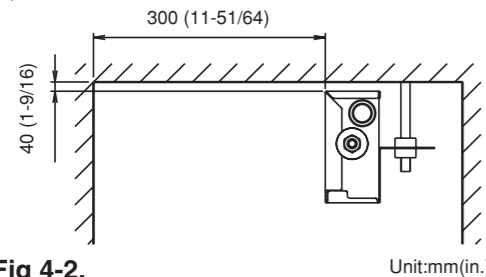

Fig 4-2.

Please install the unit in the position within 5m from indoor unit (5m in cable length).  
Please change the installation position by the type of the indoor unit and the method of taking out piping (According to various conditions, the distance between unit and indoor unit could be less than 5m).

## 5. INSTALLATION PROCEDURE

### 5-1. Unit installation

### ⚠ CAUTION

- Install in horizontal direction or vertical direction as shown in the figure, with inclination less than 5 degrees.  
Bad installation position could cause noise.

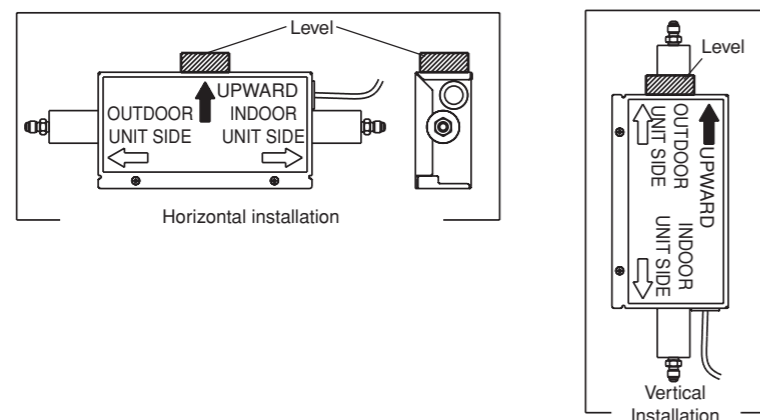

Fig 5-1.

### 5-1-1. Hanger Installation

- (1) Remove two screws (M4×10 mm) and replace with Hanger.
- (2) Fix Hanger to Hanger bolt with Special nut A and B.

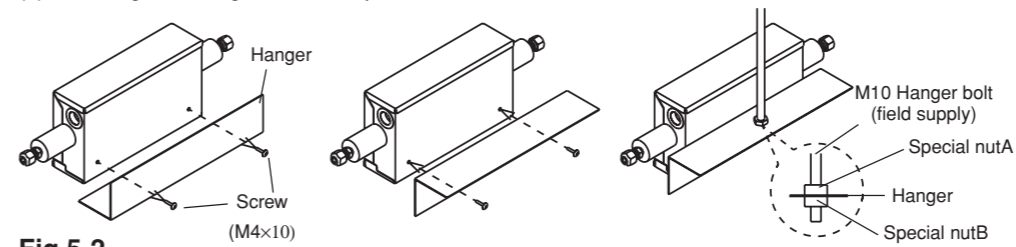

Fig 5-2.

### 5-1-2. Floor Installation

- (1) Fix the unit on floor with four screws (M4×20 mm).

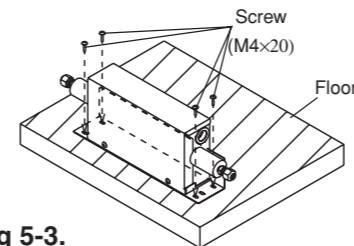

Fig 5-3.

### 5-1-3. Wall-mounted installation

- (1) Remove two screws (M4×10 mm) and replace with Hanger.
- (2) Fix the unit on wall with four screws (M4×20 mm).

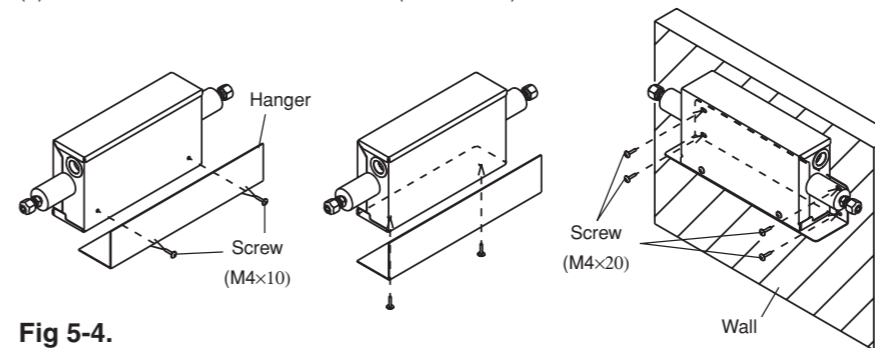

Fig 5-4.

### 5-2. Connection pipe and Installing heat insulation

### ⚠ WARNING

- Make sure that the pipe is covered completely by the insulation, not exposing to air. Inadequate heat insulation may cause condensation.

- (1) When the flare nut is tightened properly by your hand, hold the body side coupling with a separate spanner, then tighten with a torque wrench. (Fig 5-5.)
- (2) Perform a sealing test.
- (3) Insulate by the coupler heat insulation around the pipe. (Fig 5-6.)

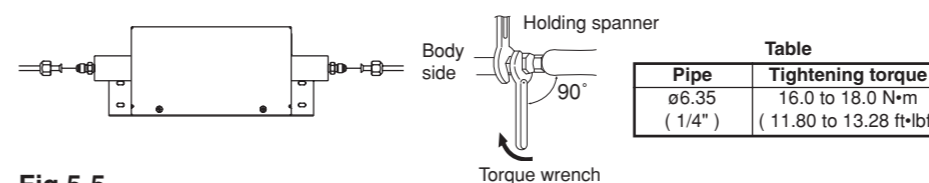

Fig 5-5.

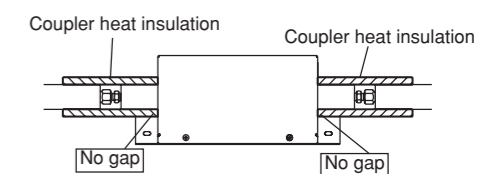

Fig 5-6.

### 5-3. Wiring

- (1) Connected the EV KIT cord to the indoor unit.
- (2) Wrap the tube around the connection, and then fasten both ends with the binders (small) (Fig 5-7.)
- (3) Fasten the EV KIT cord to the piping, etc., with the binders (large) to remove any slack in the cord.

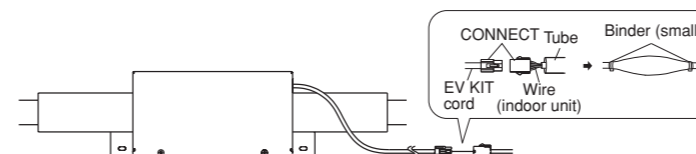

Fig 5-7.