

Air outlet shutter plate INSTALLATION MANUAL

For authorized service personnel only.

UTR-YDZK

Note: Before installation, please check the shape of the main product as shown in this manual, so that appropriate parts and accessories are used.

⚠ WARNING

When installing the Air outlet shutter plate, please read this manual thoroughly.

Before installation, be sure that all sources of power have been shut off. There is a danger of electric shock.

When installing the Air outlet shutter plate, please refer to the operating manual and installation manual supplied with the indoor unit.

Different parts are used for each model.

A UTR-YDZK (This manual)

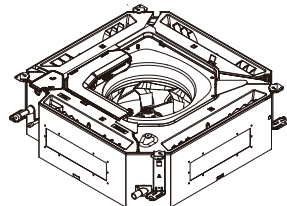
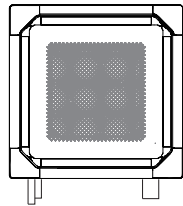



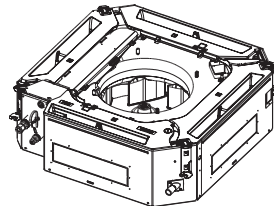
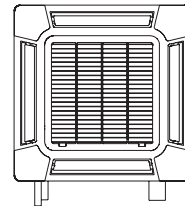



B UTR-YDZC



Parts and accessories

The following installation parts are furnished. Use them as required.

Name and Shape	Q'ty	Name and Shape	Q'ty	Name and Shape	Q'ty
Installation manual (This manual)	1	Air outlet shutter plate A 	1	Air outlet shutter plate C 	1
Shutter sheet A 	1	Air outlet shutter plate B 	1	Air outlet shutter plate D 	1
Shutter sheet B 	1				

* Parts for this model are marked with white letters.

1 Select the airflow direction and attach the Shutter sheet

(1) Select airflow direction

- Please select the airflow direction as shown in the following figure, according to the installation location.
- Do not seal 2 or more air outlets.
- The airflow direction can be selected only within the range in the figure shown below. (Otherwise, it may cause condensation)

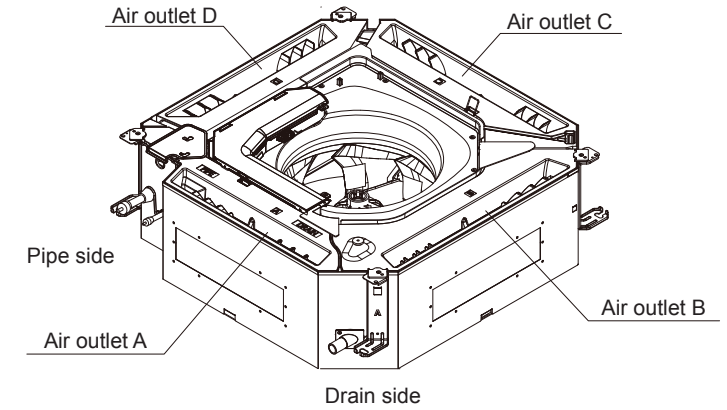
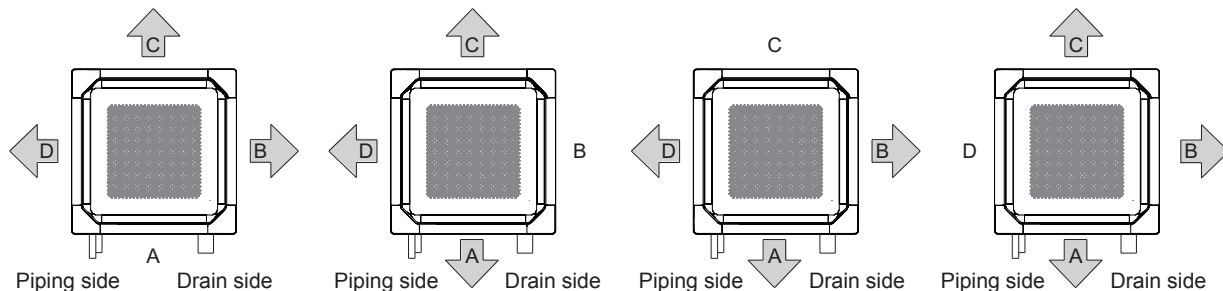

(2) With reference to the sealed air outlet as shown in figure A to D, process the Air outlet shutter plate and Shutter sheet.

<How to process the Air outlet shutter plate and Shutter sheet>

[Step 1] Attach the Air outlet shutter plate onto the Shutter sheet.

- Peel off the removable paper of the Shutter sheet.
- As shown in the figure below, attach the Air outlet shutter plate.
- When pasting, be sure to pay attention to the direction of Air outlet shutter plate.

When attaching the Shutter sheet, be sure to indicate the mark of enclosed air outlet.

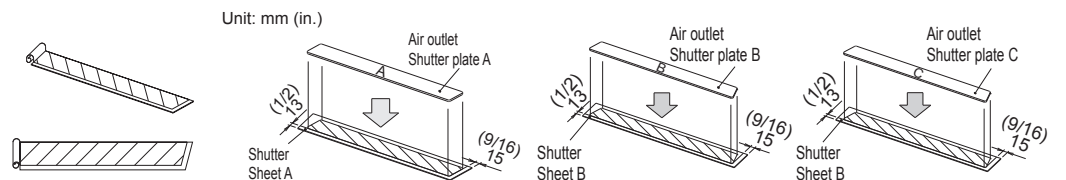

When enclosing air outlet D the Shutter sheet B, needs to be processed. Cut along the eyelet (-- position) of the Shutter sheet B.

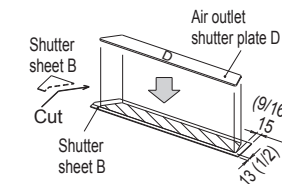

[Step 2] Attach the Shutter sheet processed in [Step 1] onto the air outlet of indoor units.

- Tear off the remaining release paper from the Shutter sheet.

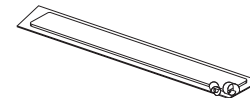

<When attaching at air outlet>

[Example] at Air outlet A

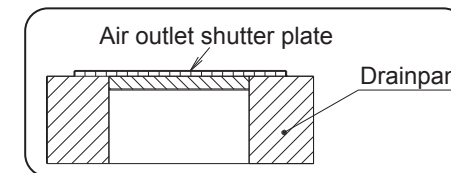
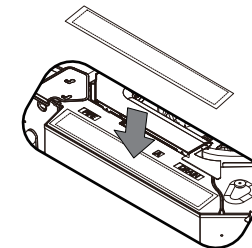

(Continued to the next page)

2 Function setting

Be sure to set the function setting with remote controller according to the on-site installation status of indoor units.
Follow the installation manual (FUNCTION SETTING) included with indoor units or remote controller.
*This function setting is not required for AIRSTAGE™(VRF SYSTEM) models.

Setting content ◆: Factory setting:

Setting Description	Function Number	Setting Value
4-way	22	00
3-way		01

◆