

AIR CONDITIONER IR RECEIVER UNIT UTY-LRHYM

INSTALLATION MANUAL

For authorized service personnel only.

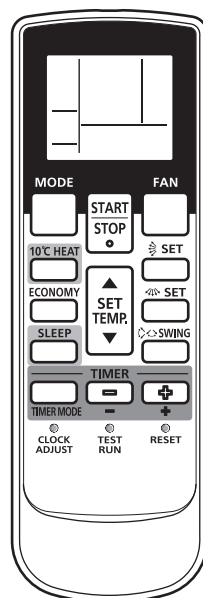
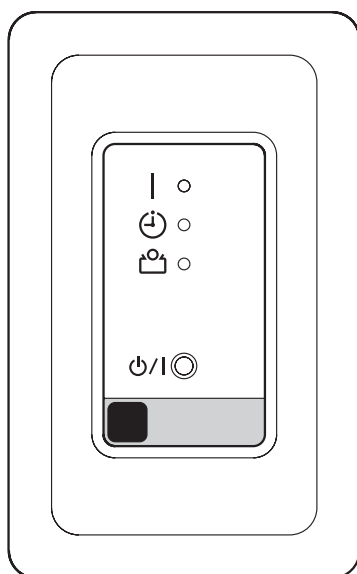

English

Deutsch

Français

Español

Italiano

Ελληνικά

Português

Русский

Türkçe

Contents

1. SAFETY PRECAUTIONS	1
2. ACCESSORIES	1
3. OPTIONAL PARTS.....	2
4. FUNCTIONS AND DIMENSIONS	2
5. SELECTING THE INSTALLATION LOCATION.....	2
6. INSTALLING THE RECEIVER UNIT	
6.1. Select the wiring pattern.....	3
6.2. Select the installation method	3
7. WIRING.....	3
8. TURNING ON THE POWER.....	4
9. SETTING THE REMOTE CONTROLLER	
9.1. Load batteries (R03/LR03 × 2).....	4
9.2. Installing the remote controller holder.....	4
10. FUNCTION SETTING	4
11. SELECTING THE REMOTE CONTROLLER SIGNAL CODE	6
12. TEST OPERATION	6
13. ERROR CODES	7

1. SAFETY PRECAUTIONS

- Let the customer keep this installation manual because it is needed when the air conditioner or receiver unit is serviced or moved.

⚠ WARNING

This mark indicates procedures which, if improperly performed, might lead to the death or serious injury of the user.

- Never touch electrical components immediately after the power supply has been turned off. Electrical shock may occur. After turning off the power, always wait 5 minutes or more before touching electrical components.
- For the air conditioner to operate satisfactorily, install it as outlined in this installation manual.
- Installation work must be performed in accordance with national wiring standards by authorized personnel only.
- Do not cut, shorten, or extend the cable in the standard parts.
- Do not turn on the power until all installation work is complete.













⚠ CAUTION

This mark indicates procedures which, if improperly performed, might possibly result in personal harm to the user, or damage to property.

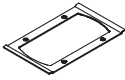
- Do not wire the receiver unit wire together with or parallel to the connection cables, transmission cables, remote controller cables, bus cable and power supply cables of the indoor and outdoor units. It may cause erroneous operation.
- Do not install the receiver unit cable near a source of electromagnetic waves.
- Do not install where there is the danger of combustible gas leakage.
- Do not install near heat sources, steam.

2. ACCESSORIES

The following installation parts are supplied.
Use them as required.

Name and Shape	Q'ty	Application
Installation manual 	1	This manual
Operating manual 	1	Instruction book for operation
Receiver unit 	1	For receiving the signal from the remote controller
Cover 	1	For covering receiver unit
Insulation 	1	For protecting PCB from dust
Receiver unit wire A 5m 	1	For connecting receiver unit wire B to receiver unit
Receiver unit wire B 0.2m 	1	For connecting receiver unit wire A to PCB of indoor unit
Bracket (cover) 	1	For fixing receiver unit to the wall or ceiling
Screw (M3 x 12mm) 	2	For installing remote controller holder to the wall
Screw (M4 x 20mm) 	2	For installing receiver unit to the wall or ceiling
Remote controller 	1	For air conditioner operation
Battery (R03/LR03) 	2	For remote controller
Remote controller holder 	1	Use as remote controller holder

3. OPTIONAL PARTS

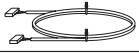
Name and Shape	Q'ty	Application	Part No.
Receiver unit wire C 10m 	1	For extending the receiver unit wire	9707598025

4. FUNCTIONS AND DIMENSIONS

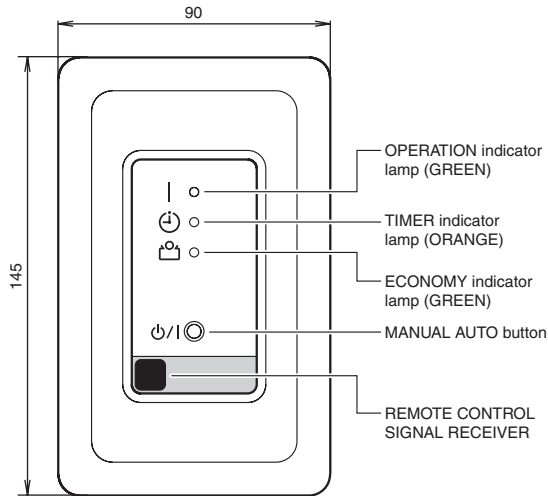

Dimensions

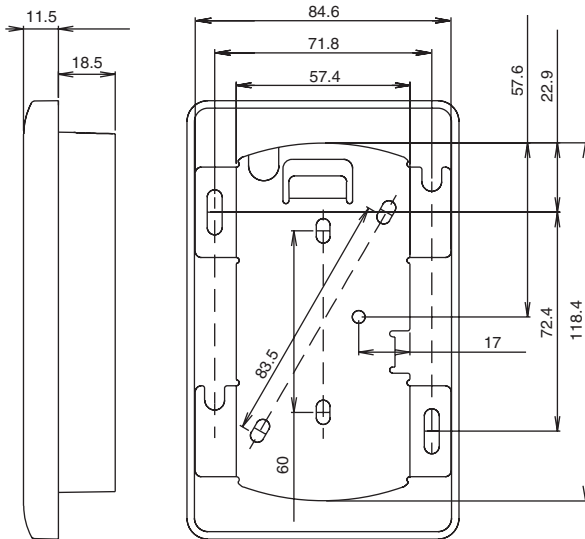

Unit: mm

5. SELECTING THE INSTALLATION LOCATION

Consult the customer and determine the installation location according to the following:

- (1) The receiver unit cable can be extended up to 10m. (To extend the wiring, purchase the optional receiver unit wire C.)
- (2) The signal reception angle of the receiver unit is shown in the figures below.
- (3) Do not install the receiver unit near a fluorescent light. (The unit must be at least 1m away from a light source.)
- (4) Do not install the receiver unit where it will be exposed to direct sunlight.
- (5) Do not install the receiver unit where it will be exposed directly to the airflow from the indoor unit.

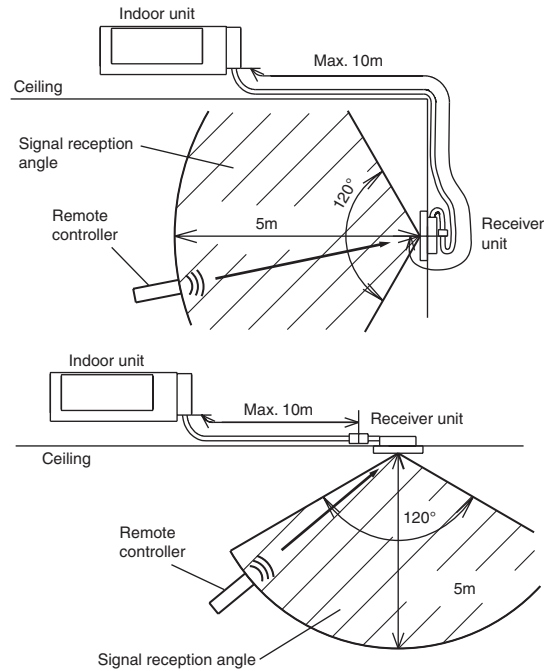

6. INSTALLING THE RECEIVER UNIT

CAUTION

- Do not touch the PCB or PCB parts of receiver unit directly with your hands.
- Fixing of the holder cover with the screws in the standard parts may be unsuitable if the wall or ceiling material is weak. If so, prepare screws suitable for the wall or ceiling material, and fix it.

6.1. Select the wiring pattern

Pattern A From the top of the receiver unit: No additional work is necessary.

Pattern B From behind the receiver unit: Perform the following procedure to route the wiring behind the receiver unit.

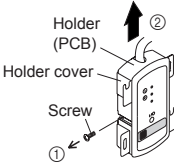
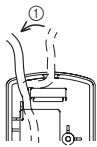
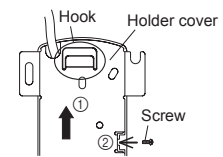
 <p>1 Remove the screw. 2 Remove holder (PCB) from holder cover.</p>	 <p>1 Route the wiring as shown in the figure.</p>
 <p>1 Reattach holder cover. (Make sure that the hook on the holder cover is caught on the holder [PCB].) 2 Fix holder (PCB) by the screw.</p>	

6.2. Select the installation method



Method 1 Receiver unit embedded in a wall or ceiling:
Refer to "I. Embedding the receiver unit."

Method 2 Receiver unit attached to a wall or ceiling:
Refer to "II. Attaching the receiver unit."

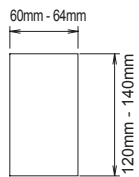
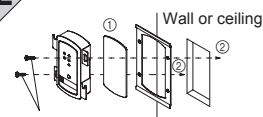
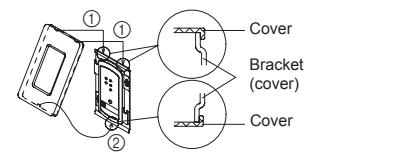
I. Embedding the receiver unit (Wiring pattern A or B)

	 <p>1 Affix the insulation to the holder cover. 2 Attach the holder cover and bracket (cover) to the wall or ceiling with the screws (included with the standard parts).</p>
 <p>1 Install the cover. Hook the 2 projections on the top of the cover onto the bracket (cover), and then hook the projection on the bottom of the cover onto the bracket (cover). 2 Make sure that there is no gap between the cover and the wall or ceiling.</p>	

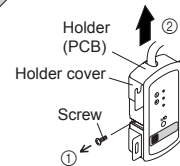
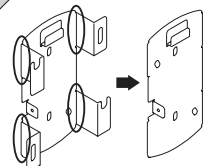
II. Attaching the receiver unit (Wiring pattern A)

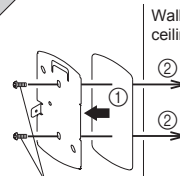
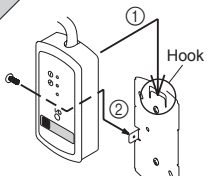
 <p>1 Remove the screw. 2 Remove holder (PCB) from holder cover.</p>	 <p>1 Cut the projections in the areas indicated with a  and remove them. (Be careful not to injure yourself on the cut edges of the holder cover.)</p>
 <p>1 Affix the insulation to the holder cover. 2 Attach the holder cover to the wall or ceiling with the screws (included with the standard parts).</p>	
 <p>1 Reattach holder cover. (Make sure that the hook on the holder cover is caught on the holder [PCB].) 2 Fix holder (PCB) by the screw.</p>	

7. WIRING

⚠ WARNING

- Before starting work, make sure that power is not being supplied to the indoor unit.
- Always fasten the outside covering of the connection cord with the cord clamp. (If the insulator is chafed, electric leakage may occur.)

⚠ CAUTION

- Do not touch the PCB or PCB parts of indoor unit directly with your hands.
- When fixing the wiring, be careful to avoid touching the edge of the indoor unit or the control box.
- Install the remote controller wires so as not to be direct touched with your hand.
- Make sure to use and roll an insulation tube of more than 1 mm thick at the connection point of the receiver unit wire A and the receiver unit wire B.

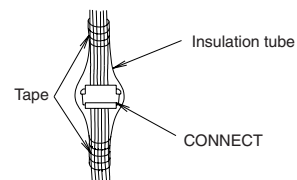

PROCEDURE

Please refer to the installation manual of each indoor unit for details.

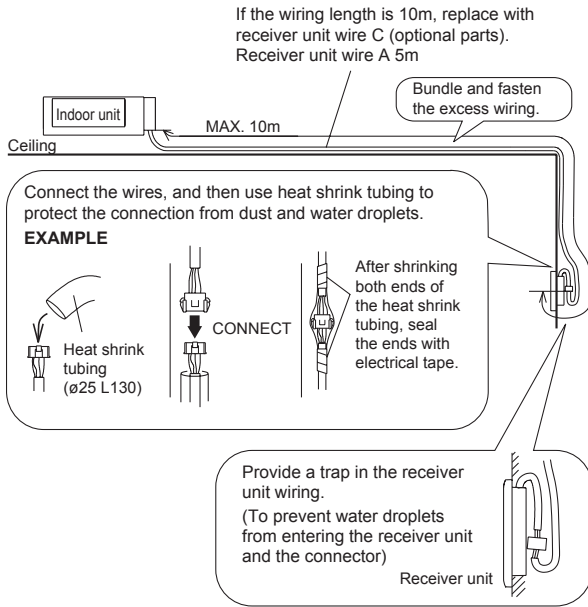

8. TURNING ON THE POWER

- ① Turn on the breaker.
- ② Make sure that the operation indicator lamp and timer indicator lamp are slowly flashing alternately.
 - If the auto restart function has been set, the air conditioner will operate with the settings immediately before the power supply was turned off.
 - If an error has occurred, the lamps on the receiver unit will flash quickly to indicate the error code. (Referring to 13 of this installation manual)

9. SETTING THE REMOTE CONTROLLER

9.1. Load batteries (R03/LR03 × 2)

- ① Press and slide the battery compartment lid on the reverse side to open it.
Slide in the direction of the arrow while pressing the ▾ mark.
- ② Insert batteries.
Be sure to align the battery polarities (⊕/⊖) correctly.
- ③ Close the battery compartment lid.

CAUTION

- Take care to prevent infants from accidentally swallowing batteries.
- When not using the Remote Controller for an extended period, remove the batteries to avoid possible leakage and damage to the unit.
- If leaking battery fluid comes in contact with your skin, eyes, or mouth, immediately wash with copious amounts of water, and consult your physician.
- Dead batteries should be removed immediately and disposed of properly, either in a battery collection receptacle or to the appropriate authority.
- Do not attempt to recharge dry batteries.

NOTES

- Never mix new and used batteries, or batteries of different types.
- Batteries should last about 1 year under normal use. If the Remote Controller's operating range becomes appreciably reduced, replace the batteries and press the RESET button with the tip of a ballpoint pen or other small object.

9.2. Installing the remote controller holder

CAUTION

- Check that the indoor unit correctly receives the signal from the remote controller, then install the remote controller holder.
- Select the remote controller holder selection site by paying careful attention to the following:
Avoid places in direct sunlight.
Select a place that will not be affected by the heat from a stove, etc.
- Install the remote controller with a distance of 5 m between the remote controller and the signal receiver of the receiver unit as the criteria.
However, when installing the remote controller, check that it operates positively.
- Install the remote controller holder to a wall, pillar, etc. with the screw.

(1) Mount the Holder.

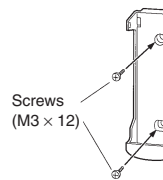

(2) Set the Remote Controller.

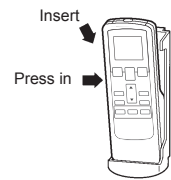

(3) To remove the Remote Controller (when use at hand).

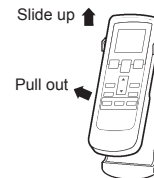

10. FUNCTION SETTING

Perform the "FUNCTION SETTING" according to the installation conditions using the remote controller.

Entering the Function Setting Mode

- While pressing the FAN button and SET TEMP. (▲) simultaneously, press the RESET button to enter the function setting mode.

STEP 1

Selecting the Remote Controller Signal Code

Use the following steps to select the signal code of the remote controller. (Note that the air conditioner cannot receive a signal code if the air conditioner has not been set for the signal code.)

The signal codes that are set through this process are applicable only to the signals in the FUNCTION SETTING.

For details on how to set the signal codes through the normal process, refer to 11.

SELECTING THE REMOTE CONTROLLER SIGNAL CODE.

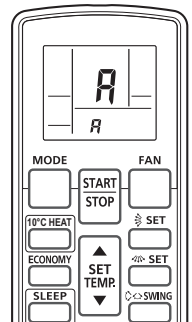

- ① Press the SET TEMP. (▲) (▼) button to change the signal code between $\bar{A} \rightarrow \bar{B} \rightarrow \bar{C} \rightarrow \bar{d}$.
Match the code on the display to the air conditioner signal code. (initially set to \bar{A})
(If the signal code does not need to be selected, press the MODE button and proceed to STEP 2.)
- ② Press the TIMER MODE button and check that the indoor unit can receive signals at the displayed signal code.
- ③ Press the MODE button to accept the signal code, and proceed to STEP 2.

The air conditioner signal code is set to A prior to shipment. Contact your retailer to change the signal code.

The remote controller resets to signal code A when the batteries in the remote controller are replaced. If you use a signal code other than signal code A, reset the signal code after replacing the batteries.

If you do not know the air conditioner signal code setting, try each of the signal codes (A → B → C → D) until you find the code which operates the air conditioner.

STEP 2

SELECTING THE FUNCTION NUMBER AND SETTING VALUE

Refer to the indoor unit installation manual for details on the function numbers and setting values.

Selecting the Function Number and Setting Value

- ① Press the SET TEMP. (▲) (▼) buttons to select the function number. (Press the MODE button to switch between the left and right digits.)
- ② Press the FAN button to proceed to setting the value. (Press the FAN button again to return to the function number selection.)
- ③ Press the SET TEMP. (▲) (▼) buttons to select the setting value. (Press the MODE button to switch between the left and right digits.)
- ④ Press the TIMER MODE button, and START/STOP button, in the order listed to confirm the settings.
- ⑤ Press the RESET button to cancel the function setting mode.
- ⑥ After completing the FUNCTION SETTING, be sure to turn off the power and turn it on again.

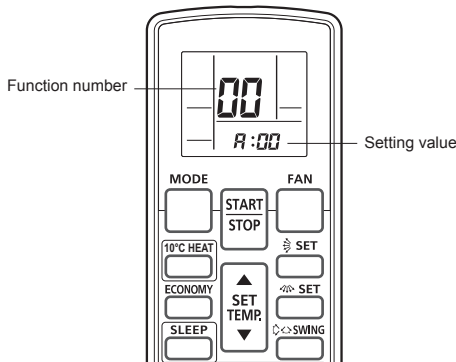

CAUTION

After turning off the power, wait 10 seconds or more before turning it on again. The FUNCTION SETTING doesn't become effective if it doesn't do so.

Function Details

	Functions	Function number	Slim duct
1)	Filter sign	11	●*1
2)	Static pressure	-	●
3)	Cooler room temperature correction	30	●
4)	Heater room temperature correction	31	●
5)	Auto restart	40	●
6)	Indoor room temperature sensor switching function	42	●
7)	Remote controller signal code	44	●
8)	External input control	46	●
9)	Room temperature control switching	48	●

*1: It is effective only to install IR Receiver unit.

1) Filter sign

The indoor unit has a sign to inform the user that it is time to clean the filter. Select the time setting for the filter sign display interval in the table below according to the amount of dust or debris in the room. If you do not wish the filter sign to be displayed, select the setting value for "No indication".

(◆... Factory setting)

Setting description	Function number	Setting value
Standard	11	00
Long interval		01
Short interval		02
No indication		03

The filter sign interval time is different according to Indoor unit type.

Please refer to the installation manual of each indoor unit for details.

● FILTER INDICATOR RESET

It lights on if the filter became dirty.

Clean the filter referring to "CLEANING AND CARE (indoor unit operating manual)".

After cleaning, press the MANUAL AUTO button (indoor unit) for 2 seconds or less on the indoor unit.

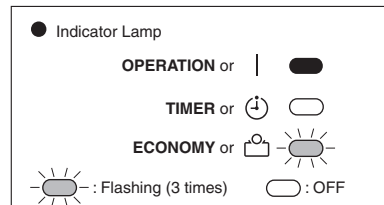

2) Static pressure

Select appropriate static pressure according to the installation conditions. Please refer to the installation manual of each indoor unit for details.

3) Cooler room temperature correction

Depending on the installed environment, the room temperature sensor may require a correction.

Please refer to the installation manual of each indoor unit for details.

4) Heater room temperature correction

Depending on the installed environment, the room temperature sensor may require a correction.

Please refer to the installation manual of each indoor unit for details.

5) Auto restart

Enable or disable automatic system restart after a power outage.

(◆... Factory setting)

Setting description	Function number	Setting value
Yes	40	00
No		01

* Auto restart is an emergency function such as for power failure etc.

Do not start and stop the indoor unit by this function in normal operation.

Be sure to operate by the controller, or external input device.

6) Indoor room temperature sensor switching function

(Only for Wired remote controller)

The following settings are needed when use the control by Wired remote controller temperature sensor.

(◆... Factory setting)

Setting description	Function number	Setting value
No	42	00
Yes		01

* If setting value is "00" :

Room temperature is controlled by the indoor unit temperature sensor.

* If setting value is "01" :

Room temperature is controlled by either indoor unit temperature sensor or remote controller unit sensor.

7) Remote controller signal code

Change the indoor unit Signal Code, depending on the remote controllers.
(◆... Factory setting)

Setting description	Function number	Setting value
◆ A	44	00
B		01
C		02
D		03

8) External input control

"Operation/Stop" mode or "Forced stop" mode can be selected.
(◆... Factory setting)

Setting description	Function number	Setting value
◆ Operation/Stop mode	46	00
(Setting forbidden)		01
Forced stop mode		02

9) Room temperature control switching

(Only for Wired remote controller)
This setting is used to set the room temperature control method when the wired remote controller is selected by the Indoor Room Temperature Sensor Switching Function.

(◆... Factory setting)

Setting description	Function number	Setting value
◆ Control by the sensors of both the indoor unit and the wired remote controller.	48	00
Control only by the sensor of the wired remote controller		01

10) Setting record

Record any changes to the settings in the following table.

Setting description	Setting value
Filter sign	
Static pressure	
Cooler room temperature correction	
Heater room temperature correction	
Auto restart	
Indoor room temperature sensor switching function	
Remote controller signal code	
External input control	
Room temperature control switching	

After completing the FUNCTION SETTING, be sure to turn off the power and turn it on again.

11. SELECTING THE REMOTE CONTROLLER SIGNAL CODE

When 2 or more air conditioners are installed in a room and the remote controller is operating an air conditioner other than the one you wish to set, change the signal code of the remote controller to operate only the air conditioner you wish to set (4 selections possible).

When two or more air conditioners are installed in a room, please contact your retailer to set the individual air conditioner signal codes.

Selecting the Remote Controller Signal Code

Use the following steps to select the signal code of the remote controller. (Note that the air conditioner cannot receive a signal code if the air conditioner has not been set for the signal code.)

- Press the START/STOP button until only the clock is displayed on the remote controller display.
- Press the MODE button for at least 5 seconds to display the current signal code (initially set to A).

- Press the SET TEMP. (\blacktriangle) (\blacktriangledown) button to change the signal code between $\text{A} \rightarrow \text{B} \rightarrow \text{C} \rightarrow \text{D}$. Match the code on the display to the air conditioner signal code.
- Press the MODE button again to return to the clock display. The signal code will be changed.

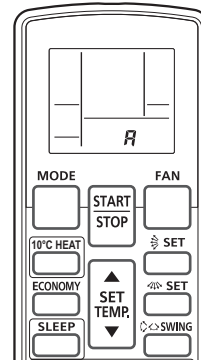

If no buttons are pressed within 30 seconds after the signal code is displayed, the system returns to the original clock display. In this case, start again from step 1.

The air conditioner signal code is set to A prior to shipment. Contact your retailer to change the signal code.

The remote controller resets to signal code A when the batteries in the remote controller are replaced. If you use a signal code other than signal code A, reset the signal code after replacing the batteries. If you do not know the air conditioner signal code setting, try each of the signal codes ($\text{A} \rightarrow \text{B} \rightarrow \text{C} \rightarrow \text{D}$) until you find the code which operates the air conditioner.

12. TEST OPERATION

The outdoor unit may not operate depending on the room temperature. In this case, press the test run button on the remote controller while the air conditioner is running. (Point the transmitter section of the remote controller toward the air conditioner and press the test run button with the tip of a ballpoint pen, etc.)

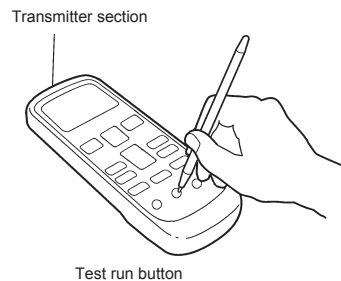

To end test operation, press the remote controller START/STOP button.

13. ERROR CODES

If you use a wired type remote control, error codes will appear on the remote control display. If you use a wireless remote control, the lamp on the IR receiver unit will output error codes by way of blinking patterns. See the lamp blinking patterns and error codes in the table below. An error display is displayed only during operation.

Error display			Wired remote controller Error code	Mode	DESCRIPTION
OPERATION lamp (green)	TIMER lamp (orange)	ECONOMY lamp (green)			
● (1)	● (1)	◇	11	Communication	Serial communication error
● (1)	● (2)	◇	12	Communication	Remote controller communication error
● (1)	● (5)	◇	15	Communication	Scan error
● (2)	● (1)	◇	21	Function setting	Initial setting error
● (2)	● (2)	◇	22	Function setting	Indoor unit capacity error
● (2)	● (3)	◇	23	Function setting	Connection disabled (series error)
● (2)	● (4)	◇	24	Function setting	Connection unit number error
● (3)	● (2)	◇	32	Indoor unit	Indoor unit main PCB error
● (3)	● (5)	◇	35	Indoor unit	Manual auto switch error
● (4)	● (1)	◇	41	Indoor unit	Room (temperature) thermistor error
● (4)	● (2)	◇	42	Indoor unit	Indoor unit Heat Ex. sensor error
● (5)	● (1)	◇	51	Indoor unit	Indoor unit fan motor error
● (5)	● (3)	◇	53	Indoor unit	Water Drain error
● (5)	● (15)	◇	5U	Indoor unit	Indoor unit error
● (6)	● (2)	◇	62	Outdoor unit	Outdoor unit main PCB error
● (6)	● (3)	◇	63	Outdoor unit	Inverter PCB error
● (6)	● (4)	◇	64	Outdoor unit	Active filter error, PFC circuit error

● (6)	● (5)	◇	65	Outdoor unit	IPM error
● (6)	● (10)	◇	6A	Outdoor unit	Display panel error
● (7)	● (1)	◇	71	Outdoor unit	Discharge thermistor error
● (7)	● (2)	◇	72	Outdoor unit	Compressor thermistor error
● (7)	● (3)	◇	73	Outdoor unit	Outdoor unit Heat Ex. Sensor error
● (7)	● (4)	◇	74	Outdoor unit	Outdoor thermistor error
● (7)	● (5)	◇	75	Outdoor unit	Suction Gas thermistor error
● (7)	● (7)	◇	77	Outdoor unit	Heat sink thermistor error
● (8)	● (2)	◇	82	Outdoor unit	Sub-cool Heat Ex. gas thermistor error
● (8)	● (3)	◇	83	Outdoor unit	Liquid pipe thermistor error
● (8)	● (4)	◇	84	Outdoor unit	Current sensor error
● (8)	● (6)	◇	86	Outdoor unit	Pressure sensor error
● (9)	● (4)	◇	94	Outdoor unit	Trip detection
● (9)	● (5)	◇	95	Outdoor unit	Compressor motor control error
● (9)	● (7)	◇	97	Outdoor unit	Outdoor unit fan motor 1 error
● (9)	● (9)	◇	99	Outdoor unit	4-way valve error
● (10)	● (1)	◇	A1	Refrigerant system	Discharge temperature 1 error
● (10)	● (3)	◇	A3	Refrigerant system	Compressor temperature error
● (10)	● (5)	◇	A5	Refrigerant system	Pressure error 2
● (13)	● (2)	◇	J2	Branch box	Unit flow divider error

Display mode ● : 0.5s ON / 0.5s OFF

◇ : 0.1s ON / 0.1s OFF

() : Number of flashing

Wired Remote Controller Display

