

# REMOTE CONTROLLER (WIRED TYPE) INSTALLATION MANUAL



PART No. 9373328384

For authorized service personnel only.

[Original instructions]

Refer to the rating label with the serial number.

MADE IN P.R.C.

Installation by end-users or not qualified persons can cause harm to personal safety, can cause severe damage to building and product, can lead to improper function or reduced lifetime of the equipment.

## CONTENTS

1. SAFETY PRECAUTIONS .....	1
2. MAIN UNIT AND ACCESSORIES .....	1
3. ELECTRICAL REQUIREMENT .....	1
4. SELECTING AN INSTALLATION LOCATION .....	2
5. INSTALLING THE REMOTE CONTROLLER .....	3
6. INITIALIZATION PROCEDURE .....	5
7. TURN ON THE POWER .....	5
8. MENU 1 SETTINGS (for Administrator) .....	6
9. MENU 2 SETTINGS .....	6
10. SPECIAL STATE CONFIRMATION (for Administrator) .....	10
11. TEST RUN .....	10
12. ERROR CODES .....	10

## 1. SAFETY PRECAUTIONS

- The "SAFETY PRECAUTIONS" indicated in the manual contain important information pertaining to your safety. Be sure to observe them.
- For details of the operation method, refer to the operating manual.
- Request the user to keep the manual on hand for future use, such as for relocating or repairing the unit.

### ! WARNING

This mark indicates procedures which, if improperly performed, might lead to the death or serious injury of the user.

Perform installation work in accordance with the installation manual. Request an authorized service personnel to perform installation work. Do not install this unit by yourself. Improper installation will cause injury, electric shock, fire, etc.

Perform electrical work by an authorized service personnel in accordance with the installation manual and the electrical wiring regulations or implementation regulations of the country. Also do not install this unit by yourself. Improper electric work will cause electric shock or a fire.

In the event of a malfunction (burning smell, etc.), immediately stop operation, turn off the electrical breaker, and consult authorized service personnel.

Do not install the unit in the following areas:

- Do not install the unit near a source of heat, steam, or flammable gas. Otherwise, fire could result.
- Area filled with mineral oil or containing a large amount of splashed oil or steam, such as a kitchen. It will deteriorate plastic parts, causing the parts to fall.
- Area containing equipment that generates electromagnetic interference. It will cause the control system to malfunction, and cause erroneous operation.
- Install the unit in a well-ventilated place avoiding rains and direct sunlight.

Do not operate this unit when your hands are wet. Touching the unit with wet hands will cause an electric shock.

When children can approach the unit or touch the unit, take preventive measures.

Dispose of the packing materials safely. Tear and dispose of the plastic packing bags so that children cannot play with them. There is the danger of suffocation if children play with the original plastic bags.

### ! CAUTION

This mark indicates procedures which, if improperly performed, might possibly result in personal harm to the user, or damage to property.

When detecting the room temperature using the remote controller, please set up the remote controller according to the following conditions. If the remote controller is not well set, the correct room temperature will not be detected, and thus the abnormal conditions like "not cool" or "not heat" will occur even if the air-conditioner is running normally. :

- A location with an average temperature for the room being air conditioned.
- Not directly exposed to the outlet air from the air conditioner.
- Out of direct sunlight.
- Away from the influence of other heat sources.

Do not touch the switches with sharp objects. Doing so will cause injury, trouble, or electric shock.





Do not expose this unit directly to water. Doing so will cause trouble, electric shock, or heating.

Do not set vessels containing a liquid on this unit. Liquid that spills out will cause overheating, fire and electric shock.

Do not insert articles into the slit parts of this unit. Doing so will cause trouble, heating, or electric shock.

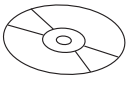
## 2. MAIN UNIT AND ACCESSORIES

The following installation parts are supplied. Use them as required.

Name and Shape	Q'ty	Name and Shape	Q'ty
Wired remote controller 	1	CD-ROM 	1
Installation manual (This manual) 	1	Screw (M4 × 16mm)  For installing the remote controller	2
Operating manual 	1	Cable tie  For binding remote controller and remote controller cable	1

## 3. ELECTRICAL REQUIREMENT

When connecting the remote controller use the following wiring.

Cable type	Size	Remarks
Sheathed cable	0.33 to 1.25 mm <sup>2</sup> (22 to 16 AWG)	Non polar 2 core, Twisted pair
Shielded cable*		

\* Use shielded cable in accordance with local rules for remote controller cable.

Select a flexible cable that can be bound using cable ties from over the cable sheath inside this unit.

Maximum connectable number of remote controllers by cable size and the length.

AWG	Cable size mm <sup>2</sup>	Max. connectable number of remote controllers					
		L* ≤ 100 m		100 m < L* ≤ 250 m		250 m < L* ≤ 500 m	
		VRF	RAC	VRF	RAC	VRF	RAC
16	1.25	4	2	4	2	4	2
18	0.75 (1.25 > S* ≥ 0.75)	4	2	4	2	2	2
20	0.5 (0.75 > S* ≥ 0.5)	4	2	2	2	2	2
22	0.3 (0.5 > S* ≥ 0.3)	4	2	1	1	1	1

\* L: Total cable length, \*S: Cable size

English

Deutsch

Français

Español

Italiano

Ελληνικά

Português

Русский

Türkçe

中文

## 4. SELECTING AN INSTALLATION LOCATION

### 4.1. Dimensions and Name of parts

#### Remote controller unit

Unit: mm (in)

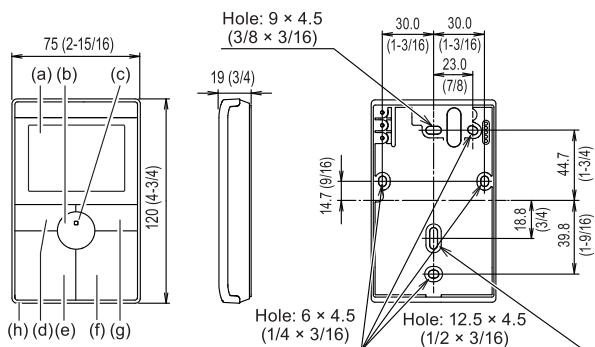

Hole: screw hole to set this unit

- (a) Display panel
- (b) "⏻/| " button:  
It is possible to operate only while displaying the "Monitor Mode" screen.
- (c) LED lamp (Operation indicator)
- (d) "⊞ MODE " button: Set the operation mode. Refer to operating manual. (This button may not appear depending on the model.)
- (e) "TEMP. ^", "TEMP. v " button (Set temperature button):  
Set the operating temperature on "Monitor Mode" screen. Refer to operating manual.
- (f) "FAN ^", "FAN v " button: Set the fan speed. Refer to operating manual.
- (g) "LOUVER " button: Set the airflow direction.
- (h) Room temperature sensor (inside)

#### Screen display

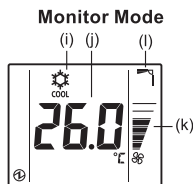

- (i) Operation mode indicator: Refer to operating manual.



- (j) Temperature indicator: Refer to operating manual.
- (k) Fan speed indicator: Refer to operating manual.
- (l) Airflow direction indicator: Refer to operating manual.

"Monitor Mode" screen is the home screen of this unit. Except for in the following cases, the screen will go back to the "Monitor Mode" screen if there is no operation for over 10 min. (Unsaved settings will be cancelled.)

- In Menu 1 settings
- In Menu 2 settings

### Status Icons

	Mode mismatch		Emergency stop
	Filter sign*		Operation controlled
	Defrost operation		Forced Stop
	Oil recovery operation		Remote controller sensor is enabled*
	Under maintenance		Central controlled
	Error		Setting temperature range is enabled
	Special state		Operation prohibited
	Conducting electricity		

If "Special state" displays, it is possible to confirm the contents by performing the operations described in "10. SPECIAL STATE CONFIRMATION".

(\*: For RAC system, to use this function, set the Function setting of the indoor unit accordingly.)

### 4.2. Specifications

Input voltage	DC 12 V
Power consumption	Max. 0.3 W
Display	Monochrome segment LCD
Usage temperature range	0 to 46 °C (32 to 114 °F)
Usage humidity range	0 to 90 % (no condensation)
Storage temperature range	-20 to 70 °C (-4 to 158 °F)
Storage humidity range	0 to 90 % (no condensation)
Dimensions [H × W × D mm (in)]	120 × 75 × 19 (4-3/4 × 2-15/16 × 3/4 )
Weight [g (oz)]	120 (4)

### 4.3. Setting the room temperature detection

#### CAUTION

As the temperature sensor of remote controller detects the temperature near the wall, when there is a certain difference between the room temperature and the wall temperature, the sensor will not detect the room temperature correctly sometimes. Especially when the outer side of the wall on which the sensor is positioned is exposed to the open air, it is recommended to use the temperature sensor of the indoor unit to detect the room temperature when the indoor and outdoor temperature difference is significant.

The detection location of the room temperature can be selected from the 2 methods at the right. The temperature sensor of the indoor unit or the remote controller can be used to detect the room temperature. Choose the detection location that is best for the installation location.

A sensor of the indoor unit (inside)

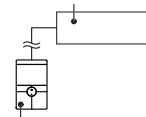

A sensor of the remote controller (inside)

If using the remote control sensor, setting is required. Refer to "9.1.3. Remote controller sensor setting". (For the RAC system, in order to use this function, set to "Use wired remote controller internal temperature sensor" with the indoor unit function settings.)

## 4.4. Installation space

- This product cannot be installed in wall.
- Recommendation installation height of the remote controller is 1.4 m (55 in) (from the floor surface to the bottom of the remote controller).
- Even when you install a remote controller to one of a switch box and the surface of a wall, secure the space shown in following figure. When there is insufficient space, there may be remote controller sensor misdetections and remote controller removal may be difficult.

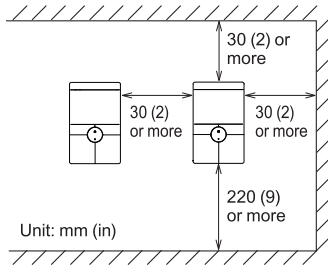

\* Please secure enough space where a flat-blade screwdriver to take off a case can be inserted.

## 5. INSTALLING THE REMOTE CONTROLLER

### ⚠ WARNING

Always use the accessories and specified installation work parts. Check the state of the installation parts. Not using the specified parts will cause units to fall off, water leakage, electric shock, fire, etc.

Install at a place that can withstand the weight of the unit and install positively so that the unit will not topple or fall.

When installing this unit, make sure that there are no children nearby. Otherwise, injury or electric shock could result.

Before starting installation work, turn off the power of this unit and the connection destination. Do not turn on the power again until installation is completed. Otherwise, it will cause electric shock or fire.

Use the accessories or specified power supply cable and remote controller cables. Do not modify power supply cable and remote controller cables other than those specified, do not use extension cords, and do not use independent branch wiring. It will cause electric shock or fire.

Install the remote controller cables securely to the terminal block. Confirm that external force is not applied to the cable. Use remote controller cables made of the specified wire. If intermediate connection or insertion fixing are imperfect, it will cause electric shock, fire, etc.

When connecting the remote controller cable, route the cables so that the rear case of this unit is securely fixed. If the rear case is imperfectly fixed, it may cause fire or overheating of the terminals.

Always fasten the cable sheath of the connection cable with the cable tie. If the cable sheath is chafed, electric leakage may occur.

### ⚠ CAUTION

Do not set the DIP switch or rotary switch of this unit except as specified in this manual or the operating manual supplied with the air conditioner. Setting the switches other than specified will cause an accident or trouble.

Use an insulated screwdriver to set the DIP switches.

Before opening the case of this unit, completely discharge static electricity charged on you body. Not doing so will cause trouble.

Do not touch the circuit board and circuit board parts directly with your hands. Otherwise, injury or electric shock could result.

Do not overtighten the screws. It will cause damage of this unit.

Install the remote controller cables 1 m away from television and radio to avoid distorted images and noise.

Confirm the name of each terminal block of the unit and connect the wiring in accordance with the directions given in the manual. Improper wiring work will damage the electric parts and cause smoke and fire.

When installing the connection cable near a source of electromagnetic waves, use shielded cable. Otherwise, a breakdown or malfunction could result.

## 5.1. Wiring types

### 5.1.1. Single control

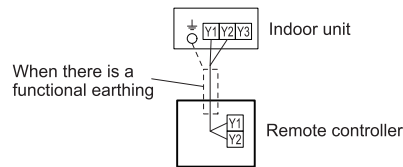

### 5.1.2. Group control

With a single remote controller, multiple indoor units can be simultaneously operated. (Number of connectable indoor units, depends on the system.)

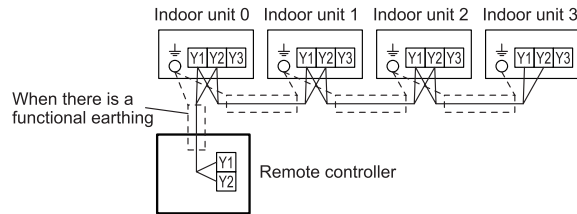

### 5.1.3. Multiple wired remote control

Number of connectable remote controllers. VRF: 4, RAC: 2

In the multiple installation method, combining 3 wired type with 2 wired type is prohibited.

In multiple wired remote control, the following functions are restricted.

Functions that can only be used with a Master Remote Controller:

- 9.1.5. Function setting
- 9.2.5. Check the indoor unit position

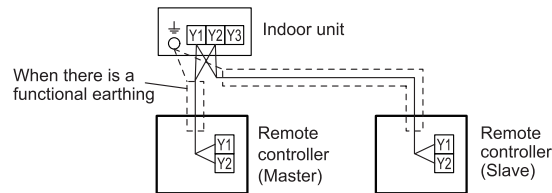

Group control and multiple wired remote control can be used together.

## 5.2. Preparing for Installation

### 5.2.1. Strip of the remote controller cable (remote controller side)

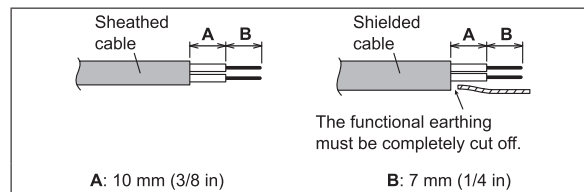

The functional earthing must be cut off. Failure to do so could cause a short to occur on the board, which could lead to damage, smoke, or even fire.

### 5.2.2. Remove the front case

When open the remote controller, remove the connector from the front case. The cables may break if the connector is not removed and the front case hangs down. When installing the front case, connect the connector to the front case. When removing and connecting the connector, be careful not to break the cables.

Lift up the upper case while inserting the flat-blade screwdriver into the slot, and separate from the lower case.

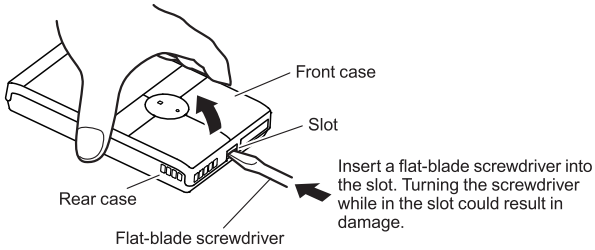

Disconnect the connection cable connector from the connector of the front case PC board (printed circuit board).

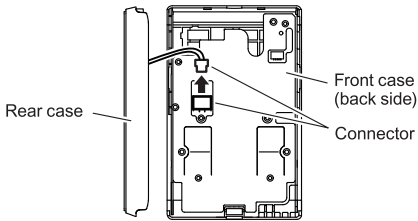

## 5.3. Installation

### 5.3.1. Install the rear case

#### A. When mounting on the box:

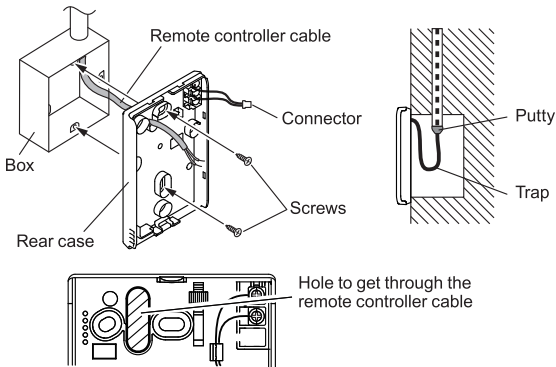

#### B. When the cable is along the wall:

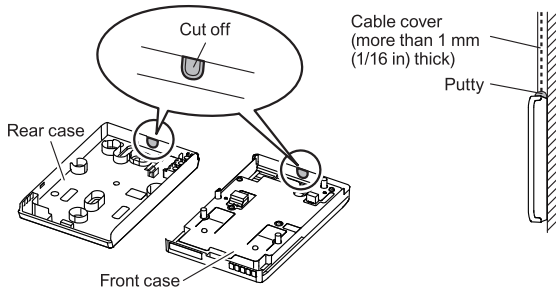

### 5.3.2. Connecting the remote controller cable

#### CAUTION

When connecting a remote controller cable to the remote controller terminal block, please use the specified torque to tighten screws. If you over-tighten screws, they will break the terminal unit.

Be careful to avoid breaking the cable by over-tightening the cable tie.

#### Tightening torque

0.8 to 1.2 N•m (8 to 12 kgf•cm)

Fasten the connection cable with the cable tie.

Tighten the cable tie firmly so that pulling force does not propagate to the terminal connection even if force of 30 N is applied to the cable.

Select a flexible cable that can be bound using cable ties from over the cable sheath inside this unit.

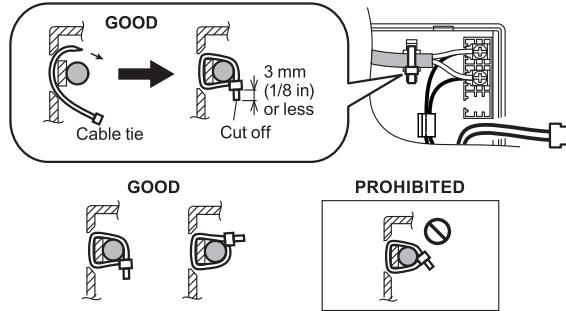

Install a cable tie in the direction as illustrated. Cut the end of the cable tie to the length as illustrated. Failure to do so may cause the end of the cable tie to press onto the board, which could cause damage.

### 5.3.3. Attach the front case

- Connect the connection cable connector to the connector of the front case PC board.
- Insert after adjusting upper part of front case. Otherwise, there is a risk of damage to the internal parts of this unit. When you attach the front case, make sure that the cables are not being pinched by front case.

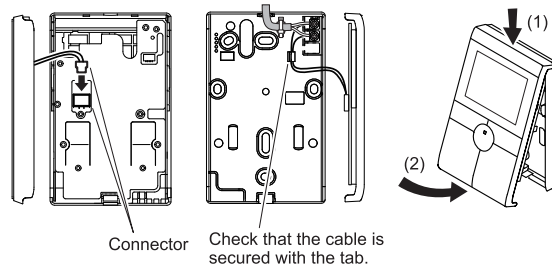

## 5.4. Connecting to the indoor unit

### CAUTION

When connecting the remote controller cable to the indoor unit, do not connect it to the outdoor unit or the power terminal block. It may cause a failure.

When switching the DIP switch (SW1) on the indoor unit PC board, be sure to turn off the power supply to the indoor unit. Otherwise, the PC board of the indoor unit may be damaged.

There are 2 methods to connect the remote controller cable to the indoor unit. One is the connection using connecting cable (Included in the indoor unit), and the other is the connection the remote controller cable is connected to the exclusive terminal block of the indoor unit. (For the details, refer to the installation manual of the indoor unit to be used.)

### 5.4.1. When connecting to the connector

- Use a tool to cut off the terminal on the end of the remote controller cable, and then remove the insulation from the cut end of the cable as shown in Fig.1. Connect the remote controller cable and connecting cable as shown in Fig.2. Be sure to insulate the connection between the cables.

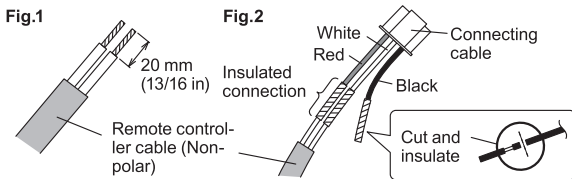

- Insert connecting cable to the connector. Set to "2WIRE" the DIP switch (SW1) on the PC board of the indoor unit.

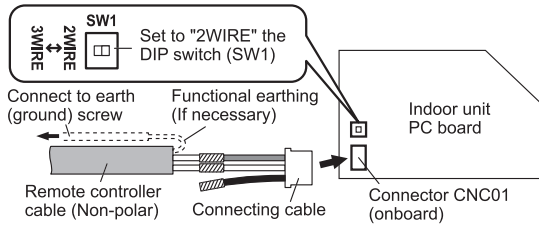

\* Layout of Connector and PC board is varies, depending on the type of indoor unit.

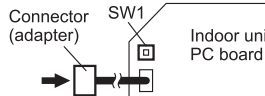

### 5.4.2. When connecting to exclusive terminal block

- Connect the end of remote controller cable directly to the exclusive terminal block. Set to "2WIRE" the DIP switch (SW1) on the PC board (printed circuit board) of the indoor unit.

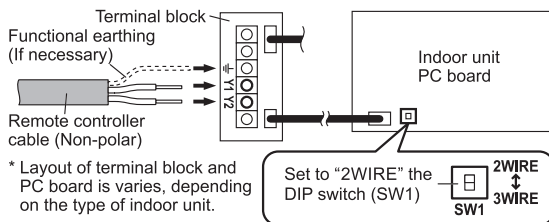

\* Layout of terminal block and PC board is varies, depending on the type of indoor unit.

For the multiple wired remote control:

#### GOOD

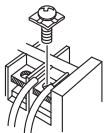

#### PROHIBITED

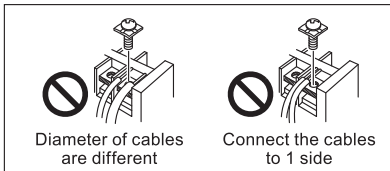

Tightening torque	
M3 screw (Remote controller / Y1, Y2)	0.5 to 0.6 N·m (5 to 6 kgf·cm)

## 6. INITIALIZATION PROCEDURE

Recheck the wiring. Incorrect wiring will cause trouble. After remote controller installation work is complete, perform initialization using the following procedures before starting to use the system.

### Turn on the power



7 Turn on the power .....page 5

### First time settings

When turning the power on for the first time, set the followings;

(1) 9.1.2. Remote controller master/slave setting .....page 7

\* This displays only when 2 or more 2-wire remote controllers are installed.

\* Factory setting is set at "Master".

First set the remote controller you wish to use as the "Master", and then set all the other remote controllers to "Slave".

(2) 9.1.1. Temperature unit setting .....page 7

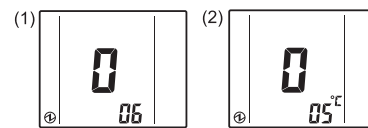

### Menu 2 settings



9. Menu 2 settings ..... page 6 to 10

### Initialization end

After installing this unit, perform the test run to confirm that the unit is operating properly. Then, explain the operation of this unit to the customer.

Note:

If an error screen is displayed, check the error code. If "26.4" or "26.5" is displayed, the error is a remote controller address error. Press the "U/I" button to display the setting screen, and perform the setting. For details on how to perform settings, please refer to "9.1.7. Remote controller address manual setting".

For other errors, refer to "12. ERROR CODES".



## 7. TURN ON THE POWER

- During start-up, some of the segments are displayed in turn, as shown on the right.

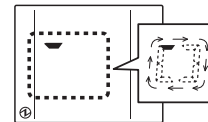

- When start-up is performed normally, the "Monitor mode" screen is displayed.



## 8. MENU 1 SETTINGS (for Administrator)

- With "Monitor Mode" screen displayed, press and hold the "TEMP. ^" button and "FAN v" button simultaneously for at least 2 seconds.
- The Menu 1 screen is displayed. (Item No. is displayed.)
- Select the item number to be set with the "TEMP. ^" or "TEMP. v" button, and press the "P/I" button to switch to the setting screen.



### Setting Items of the Menu 1

Item No.	Setting Item
A1	Filter sign reset
A2	Setting temperature range for the indoor unit

- Press the "FAN v" button to end or to suspend settings.
- Press and hold the "TEMP. ^" and "FAN v" buttons for at least 2 seconds at the same time to return to the "Monitor Mode" screen.

### Note

Selectable items differ according to settings when equipment is set up. Operation does not proceed to items that cannot be selected.

### 8.1. Filter sign reset [No.A1]

- Select the "A1" in Menu 1 Settings. Then press the "P/I" button. Press the "P/I" button to start this setting. Press the "FAN v" button to return to the Menu 1 item selection screen without applying any settings.
- Settings are complete when the "FAN v" turns off.

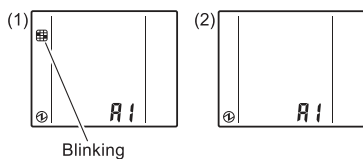

### 8.2. Setting temperature range [No.A2]

- Select the "A2" in Menu 1 Settings. Then press the "P/I" button. Select "1: Enable" with "TEMP. ^" or "TEMP. v" button. Then press the "P/I" button. (If you do not set the temperature range, select "0: Disable".)

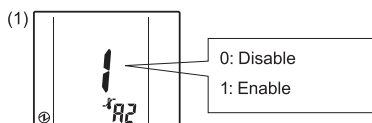

- The AUTO mode upper and lower temperature setting limits are displayed alternately. Select the operation mode you wish to set with the "TEMP. ^" or "TEMP. v" button.

### If AUTO mode is selected

- Upper temperature setting limit      Lower temperature setting limit
- - Press the "P/I" button. Press the "TEMP. ^" or "TEMP. v" button to set the upper temperature setting limit.
  - Press the "P/I" button. Press the "TEMP. ^" or "TEMP. v" button to set the lower temperature setting limit.

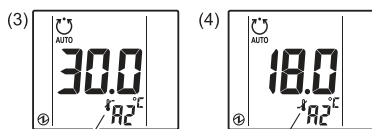

: When setting the upper temperature setting limit      : When setting the lower temperature setting limit

- Press the "P/I" button to complete the settings.

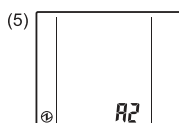

## 9. MENU 2 SETTINGS

- With "Monitor Mode" screen displayed, press and hold the "TEMP. ^" button and "FAN v" button simultaneously for at least 2 seconds.
- The Menu 1 screen is displayed. Press and hold the "FAN ^" button for at least 2 seconds. Setting mode selection screen is displayed.
- Press the "TEMP. ^" or "TEMP. v" button to select F1 (Menu 2-F1) settings mode or F2 (Menu 2-F2) settings mode.  
F1: Initial settings mode  
F2: Maintenance settings mode

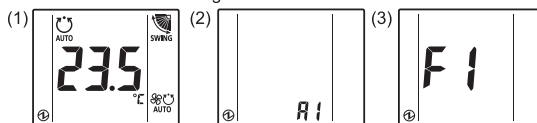

- Press the "P/I" button. Setting item selection screen is displayed. (Item No. is displayed.)
- Select the item number to be set with the "TEMP. ^" or "TEMP. v" button, and press the "P/I" button to switch to the setting screen.

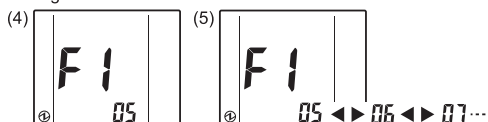

## Setting Items of the Menu 2

### F1 settings mode: Initial settings

Item No.	Setting Item
05	9.1.1. Temperature unit setting
06	9.1.2. Remote controller master/slave setting
07	9.1.3. Remote controller sensor setting
12	9.1.4. Master indoor unit setting
13	9.1.5. Function setting
14	9.1.6. Remote controller address reset
15	9.1.7. Remote controller address manual setting
30	9.1.8. LCD backlight settings
31	9.1.9. Icon description terms settings

### F2 settings mode: Maintenance settings

Item No.	Setting Item
02	9.2.1. Error details
03	9.2.2. Version
09	9.2.3. Test run
10	9.2.4. Indoor unit address verification
11	9.2.5. Check the indoor unit position
16	9.2.6. Initialization

- (6) Press the "FAN" button to end or to suspend settings.
- (7) Press and hold the "FAN" button for at least 2 seconds to return to the Menu 1 item selection screen. Then, press and hold the "TEMP." and "FAN" button for at least 2 seconds at the same time to return to the "Monitor Mode" screen.

#### Note

Selectable items differ according to settings when equipment is set up. Operation does not proceed to items that cannot be selected.

## 9.1. F1 settings mode: Initial settings

### 9.1.1. Temperature unit setting [No.05]

- (1) Select the "05" in Menu 2-F1 Settings. Then press the "OK" button.
- (2) Select the "0: °C" or the "1: °F" with the "TEMP." or "TEMP." button.

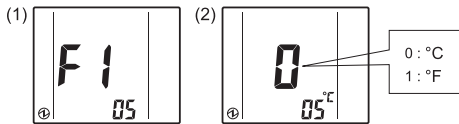

- (3) Press the "OK" button to return to the Menu 2-F1 item selection screen.

### 9.1.2. Remote controller master/slave setting [No.06]

#### Notes

- Make only one of the remote controller of the group the "Master".
- When remote controllers are set to "Slave", setting items will be restricted.

- (1) Select the "06" in Menu 2-F1 Settings. Then press the "OK" button.

- (2) Select the "0: Master" or the "1: Slave" with the "TEMP." or "TEMP." button.

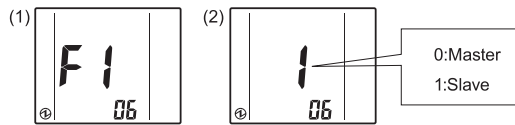

- (3) Press the "OK" button.

If there is no problem, return to Menu 2-F1 items selection screen.  
In the case of settings at initial booting, display "Monitor mode" screen.

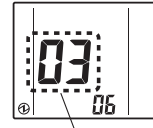

Number of Master units

- If there is 0, or 2 or more "Master" units, the number will be displayed.
- If "Master" is 0, and you wish to set this unit to "Master", repeat the settings after pressing the "OK" button.
- If "Master" is more than 2, press the "OK" button to return to the screen of (2).
- To suspend the settings part way through, press the "FAN" button. Return to the Menu 2-F1 item selection screen.

### 9.1.3. Remote controller sensor setting [No.07]

#### Note

In the case of Multiple wired remote control, there can be only one remote controller in the remote controller group for which sensor can be set to "Enable (Used)". If 2 or more remote controllers in the remote controller group are set to "Enable (Used)", and the remote controller previously set is changed to "Disable (Not used)".

- (1) Select the "07" in Menu 2-F1 Settings. Then press the "OK" button.
- (2) Select the "0: Disable (Not used)" or the "1: Enable (Used)" with the "TEMP." or "TEMP." button.

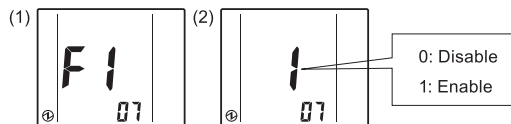

- (3) Press the "OK" button to return to the Menu 2-F1 item selection screen.

### 9.1.4. Master indoor unit setting [No.12]

#### Notes

- Master indoor unit setting cannot be set while indoor unit is running.
- For master indoor unit, specify only one remote controller group (or single indoor unit) within the refrigerant system.

- (1) Select the "12" in Menu 2-F1 Settings.
- (2) Press the "OK" button.

The current setting status is displayed.  
If "0" is displayed, press the "OK" button to set "Master indoor unit" and return to the Menu 2-F1 item selection screen.  
If "1" is displayed, press the "OK" button to set "Not Master indoor unit" and return to the Menu 2-F1 item selection screen.

Press the "FAN" button to return to the Menu 2-F1 item selection screen without applying any settings.

- (3) If "x" is displayed, press the "FAN" button to return to the Menu 2-F1 item selection screen.

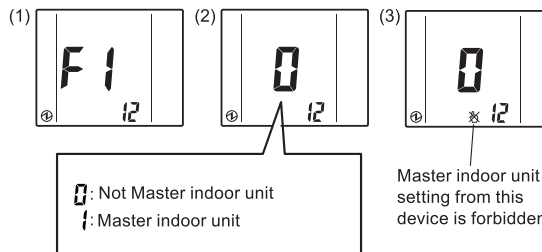

### 9.1.5. Function setting [No.13]

#### Note

This item cannot be set from slave remote controllers.

This procedure changes the function settings used to control the indoor unit according to the installation conditions. Incorrect settings can cause the system to malfunction. Perform the "Function setting" according to the installation conditions using the remote controller.

- Prepare for setting of indoor unit referring to installation manual of indoor unit before start of function setting.
- Refer to the indoor unit installation manual for details on the function numbers and setting numbers.

- (1) Select the "13" in Menu 2-F1 Settings. Then press the "⏪/| " button.

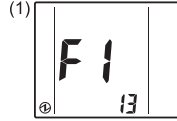

- (2) Select the 2-wire remote controller address with the "⏪ TEMP. ^ " or "⏪ TEMP. v " button. Then press the "⏪/| " button.

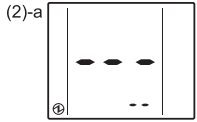

Select all

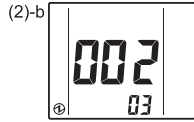

Select the 2-wire remote controller address (Ex. Select the 002-03)

- (3) Set the function number with the "⏪ TEMP. ^ " or "⏪ TEMP. v " button. Then press the "⏪/| " button.
- (4) Set the setting number with the "⏪ TEMP. ^ " or "⏪ TEMP. v " button. Then press the "⏪/| " button.
- (5) Setting results are displayed after data transmission.

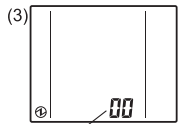

Function number

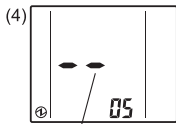

Setting number

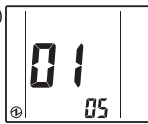

- (6) Press the "⏪/| " button to return to the 2-wire remote controller address selection screen of (2). If setting has been completed, press the "FAN v " button to return to the Menu 2-F1 item selection screen.

### 9.1.6. Remote controller address reset [No.14]

#### Notes

- If changing 2-wire remote controller address from manual to automatic allocation, perform this work after changing the remote controller address of the indoor unit to "0".
- Setting is reflected after the power is turned on again.

- (1) Select the "14" in Menu 2-F1 Settings. Then press the "⏪/| " button.
- (2) To reset the 2-wire remote controller address, select "1: Reset" with the "⏪ TEMP. ^ " or "⏪ TEMP. v " button. If not resetting, select "0: Not reset" with the "⏪ TEMP. ^ " or "⏪ TEMP. v " button.

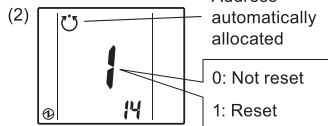

Address automatically allocated

0: Not reset  
1: Reset

- (3) Press the "⏪/| " button to return to the Menu 2-F1 item selection screen.

### 9.1.7. Remote controller address manual setting [No.15]

#### Notes

- In the case of automatic address settings, do not change the remote controller address for the indoor unit, and keep it at the initial setting of 0. Addresses will be automatically set when initially starting up this unit.
- Only set addresses manually when using different numbers for addresses. A remote controller address for the indoor unit needs to be set. Set the remote controller addresses for the indoor units which are connected using the same remote controller cable with a range from 1 to 9 and from A (10) to F(15), without any duplicates. (Do not use "0" for configuration.) For how to configure the remote controller addresses for the indoor unit, refer to its installation manual.
- The address for this unit can be set from 1 to 32. However, do not set the same number as that for the remote controller address of an indoor unit, remote controller, or other unit connected using the same remote controller cable.
- Setting is reflected after the power is turned on again.

- (1) Select the "15" in Menu 2-F1 Settings. Then press the "⏪/| " button.

- (2) You can check current allocation of 2-wire remote controller address (system number and unit number). Set the unit number with the "⏪ TEMP. ^ " or "⏪ TEMP. v " button. System number cannot be changed.

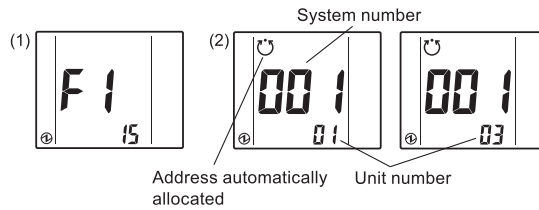

- (3) Press the "⏪/| " button to return to the Menu 2-F1 item selection screen.

### 9.1.8. LCD backlight settings [No.30]

#### Notes

- Set the backlight enable/disable setting and lighting time.
- If there is no button operation within the set time, the backlight switches off.

- (1) Select the "30" in Menu 2-F1 Settings. Then press the "⏪/| " button.
- (2) Select "1: Valid" with the "⏪ TEMP. ^ " or "⏪ TEMP. v " button, and press the "⏪/| " button. (Select "0: Invalid", and press "⏪/| " button to return to the Menu 2-F1 item selection screen.)

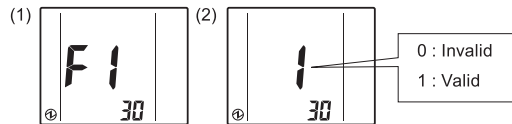

- (3) Select the "30: 30 seconds" or the "60: 60 seconds" with the "⏪ TEMP. ^ " or "⏪ TEMP. v " button.

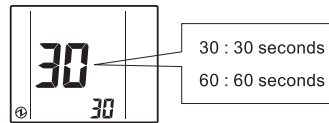

- (4) Press the "⏪/| " button to return to the Menu 2-F1 item selection screen.



### 9.1.9. Icon description terms settings [No.31]

#### Note

- Perform the settings for "Display" or "Do not display" the description terms under the MODE icon.

- Select the "31" in Menu 2-F1 Settings. Then press the "⏪/I" button.
- Select the "0: Do not display" or the "1: Display" with the "TEMP. ^" or "TEMP. v" button.

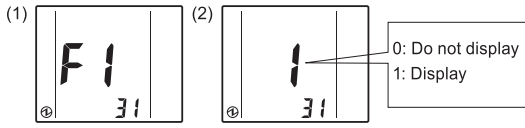

- Press the "⏪/I" button to return to the Menu 2-F1 item selection screen.

## 9.2. F2 settings mode: Maintenance

### 9.2.1. Error Details [No.02]

- Select the "02" in Menu 2-F2 Settings. Then press the "⏪/I" button.

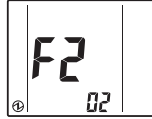

- Display the condition of this unit or indoor unit. If an error is present in other units than this unit, display of the 2-wire remote controller address can be switched by the "TEMP. ^" or "TEMP. v" button.

#### • Example of the display

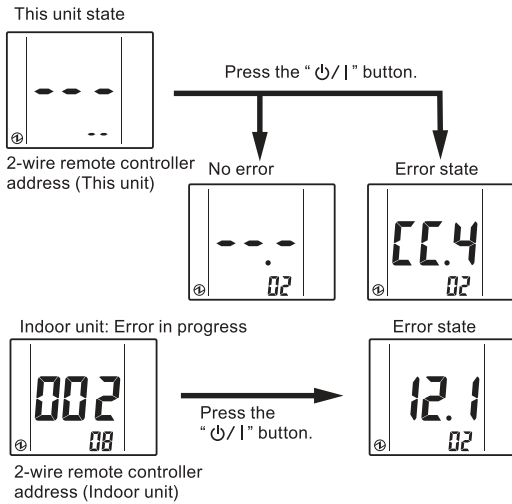

- While the error state is displayed, press "FAN v" button twice to return to Menu2-F2 item selection screen.

#### Notes

- In the case of Multiple wired remote control, errors are not displayed except for the remote controller of that unit. Check each remote controller.
- For details on error codes, refer to "12. ERROR CODES".

### 9.2.2. Version [No.03]

- Select the "03" in Menu 2-F2 Settings. Then press the "⏪/I" button.
- Select software type with the "TEMP. ^" or "TEMP. v" button.

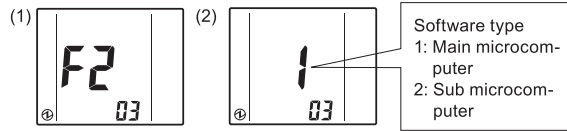

- If the "⏪/I" button is pressed, the Software version is displayed as shown below, switching every 4 seconds.

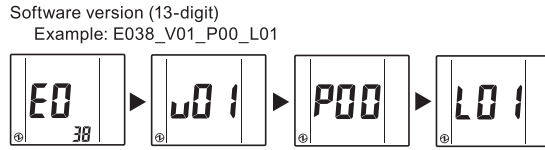

- Press the "FAN v" button to quit this display and return to screen (2). Press the "FAN v" button to return to the Menu 2-F2 item selection screen.

### 9.2.3. Test run [No.09]

#### Note

Refer to the indoor unit installation manual for the list of items to check.

- Select the "09" in Menu 2-F2 Settings. Then press the "⏪/I" button.
- The test operation screen is displayed. Press the "⏪/I" button to return to the Menu 2-F2 item selection screen, and test operation begins.

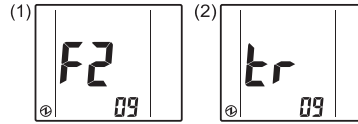

Test operation is completed after about an hour.

To quit test operation before it is complete, return to the "Monitor mode" screen and press the "⏪/I" button.

### 9.2.4. Indoor unit address verification [No.10]

- Select the "10" in Menu 2-F2 Settings. Then press the "⏪/I" button.
- Display the smallest 2-wire remote controller address of indoor unit (system number and unit number) of the remote controller group. This address displayed can be switched by the "TEMP. ^" or "TEMP. v" button.  
If an indoor unit other than VRF is connected, "-" is displayed.
- Press the "⏪/I" button to display the Refrigerant system address and Indoor unit address.

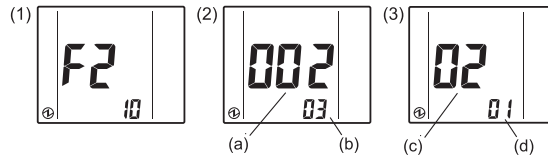

- System number (002: Indoor unit)
  - Unit number (01 to 32)
  - Refrigerant system address (00 to 99)
  - Indoor unit address (00 to 63)
- Press the "FAN v" button to return to previous screen.

### 9.2.5. Check the indoor unit position [No.11]

#### Note

This item cannot be set from slave remote controllers.

- Select the "11" in Menu 2-F2 Settings. Then press the "⏪/I" button.
- Select 2-wire remote controller address of indoor unit that notifies position. Indoor units that notify can be switched by "TEMP. ^" or "TEMP. v" button.

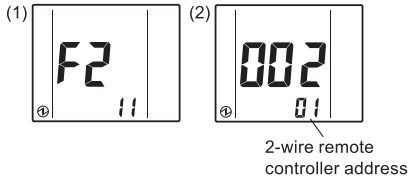

- When press the "⏪/I" button, the appropriate indoor unit performs the air blow and LED lamps blink\*. (\*Only when the indoor unit has that function.)
- Press the "FAN v" button to complete indoor unit position and return to the Menu 2-F2 item selection screen.

### 9.2.6. Initialization [No.16]

- Select the "16" in Menu 2-F2 Settings. Then press the "⏪/I" button.
- To initialize, select "1: Initialize" with the "TEMP. ^" or "TEMP. v" button. (If not initializing, select "0: Not initialize", and press the "⏪/I" button to return to the Menu 2-F2 item selection screen.)

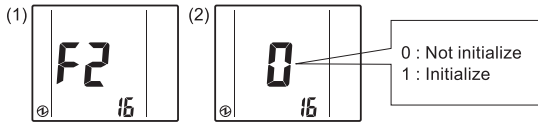

Press the "⏪/I" button to reboot the device automatically.

#### Note

When relocating the remote controller, initialize it.

## 10. SPECIAL STATE CONFIRMATION (for Administrator)

- With "Monitor Mode" screen displayed, press and hold the "TEMP. v" button and "FAN ^" button simultaneously for at least 2 seconds.
- The special state selection screen appears. The status icons appear when the unit is in a special state. (Refer to "4.1. Status Icons" for more information on these icons.)

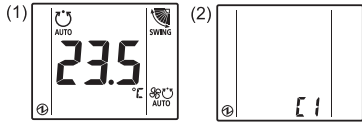

- Select the item number to be set with the "TEMP. ^" or "TEMP. v" button.

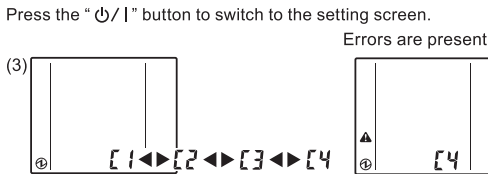

Refer to the table for the settings of each part number. For details concerning settings, refer the description of the setting concerned.

#### Confirmation Items

Item No.	Confirmation item
C1	Displays the temperature detected by the temperature sensor in this unit. The "--" string appears when the temperature sensor is damaged.
C2	Displays the configured economy operation setting. 0: Disable 1: Enable

C3	Displays the configured anti freeze operation setting. 0: Disable 1: Enable
C4	This code appears when an error has occurred. Press the "⏪/I" button. Display the condition of this unit or indoor unit. If an error is present in other units than this unit, display of the 2-wire remote controller address can be switched by the "TEMP. ^" or "TEMP. v" button. Refer to "Example error confirmation operations" described later for more information on error operation. (Press the "FAN v" button to return previous screen.)

- Press and hold the "TEMP. v" and "FAN ^" buttons for at least 2 seconds at the same time to return to the "Monitor Mode" screen.

#### • Example error confirmation operations

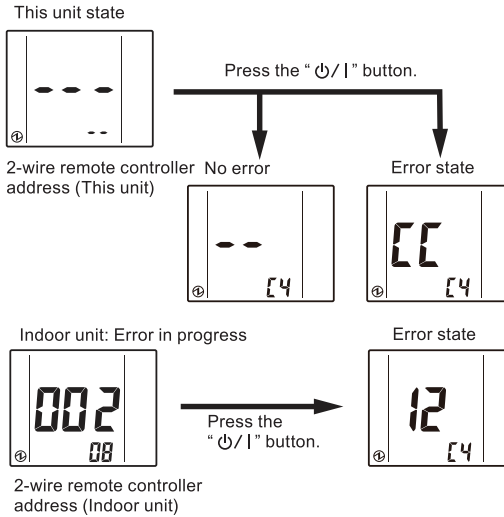

## 11. TEST RUN

- Refer to the indoor unit installation manual for the list of items to check. For how to carry out a test run, refer to "9. MENU 2 SETTINGS" → "9.2.3. Test run".

## 12. ERROR CODES

This appears automatically on the display if an error occurs.

- If an error occurs, the following display will be shown. ("▲" will appear in the "Monitor Mode" screen)



For information on how to check error details, please refer to "9.2.1. Error Details".

For the details of the indoor unit or outdoor unit error when checking the error contents, refer to the error codes in each installation manual.

#### Error of this unit

Error code	Contents
CC.1	Sensor error
C2.1	Transmission PCB error
12.1	Wired remote controller communication error
12.3	Number excess of device in wired remote controller system
12.4	Wired remote controller system start-up error
15.4	Data acquisition error
26.4	Address duplication in wired remote controller system
26.5	Address setting error in wired remote controller system
27.1	Master/slave unit setting error