

REMOTE CONTROLLER (WIRED TYPE)



UTY-RVRY
UTY-RVRG
UTY-RVRX

OPERATION MANUAL (full)

WIRED REMOTE CONTROLLER

Keep this manual for future reference.

English

OPERATION MANUAL (full)

PART No. 9360329004-01
WIRED REMOTE CONTROLLER

[Original instructions]

Contents

1 Introduction	3
1-1 Safety precautions	3
1-2 System outline	3
1-2-1 Terminology	3
1-2-2 Password configuration	4
1-3 Name of parts	4
1-4 Before operation or setting	4
1-4-1 Wake the controller	4
1-4-2 Standby mode screen	4
1-4-3 Child safety lock	5
1-4-4 Password	5
1-4-5 Message screen	5
2 Basic operation	5
2-1 Main screen configuration	5
2-1-1 Explanation of items common to the main screen	6
2-2 Operation On/Off	6
2-3 Temperature setting	7
2-3-1 Temperature screen	7
2-4 Operation mode setting	7
2-5 Fan speed setting	7
3 Other settings	8
3-1 Weekly Timer	8
3-1-1 Weekly timer screen	8
3-1-2 Day selection screen	8
3-1-3 One day schedule setting screen	8
3-1-4 Operation mode screen	9
3-1-5 Set Temp. screen	9
3-1-6 Time screen	10
3-1-7 Operation Setting screen	10
3-1-8 Day Off screen	10
3-1-9 Create the schedule	11
4 Detail	12
4-1 Air Flow Direction	13
4-1-1 Individual Hold	13
4-2 Comfort Function	14
4-2-1 Powerful	14
4-2-2 Comfort Air Flow	14
4-3 Energy-saving	14
4-3-1 Economy	14
4-3-2 Occupancy Sensor	15
4-3-3 Energy Saving Fan	16
4-3-4 Set Temp. Auto Return	16
4-4 Safety shield	17
4-4-1 Anti-Freeze	17
4-4-2 Emergency Heat	17

4-5 Cleaning	17
4-5-1 Panel Cleaning	17
4-5-2 Filter Sign Reset	17
5 Setting	18
5-1 Timer	18
5-1-1 Auto Off Timer	18
5-1-2 Outdoor unit low noise	19
5-2 Initial Setting	20
5-2-1 RC (Remote Controller) Group Name	20
5-2-2 Admin Password	21
5-2-3 Display Item	22
5-2-4 Set Temp. Limit	22
5-2-5 RC (Remote Controller) Sensor	22
5-3 Preference	23
5-3-1 Daylight Saving Time (Summer time)	23
5-3-2 Date Setting	23
5-3-3 Temperature unit	24
5-3-4 Language	24
5-3-5 Logo Display	24
5-3-6 License	24
5-3-7 Backlight	25
5-3-8 Operation Lamp	25
5-4 Service	26
5-4-1 Maintenance	26
5-4-2 Troubleshooting	26
6 Operation tips	27
6-1 Selectable Modes (for VRF system)	27
6-1-1 Heat recovery system	27
6-1-2 When indoor units are connected for cooling only in heat recovery system	27
6-1-3 RB priority connection in heat recovery system	27
6-1-4 Heat pump system	27
6-1-5 Outdoor unit priority connection in heat pump system	27
6-2 Settable temperature range	27
7 Others	28
7-1 Outline Dimensions	28
7-2 Specifications	28
7-3 Error Code	28
7-4 Information on Disposal of WEEE	28

Screen structure

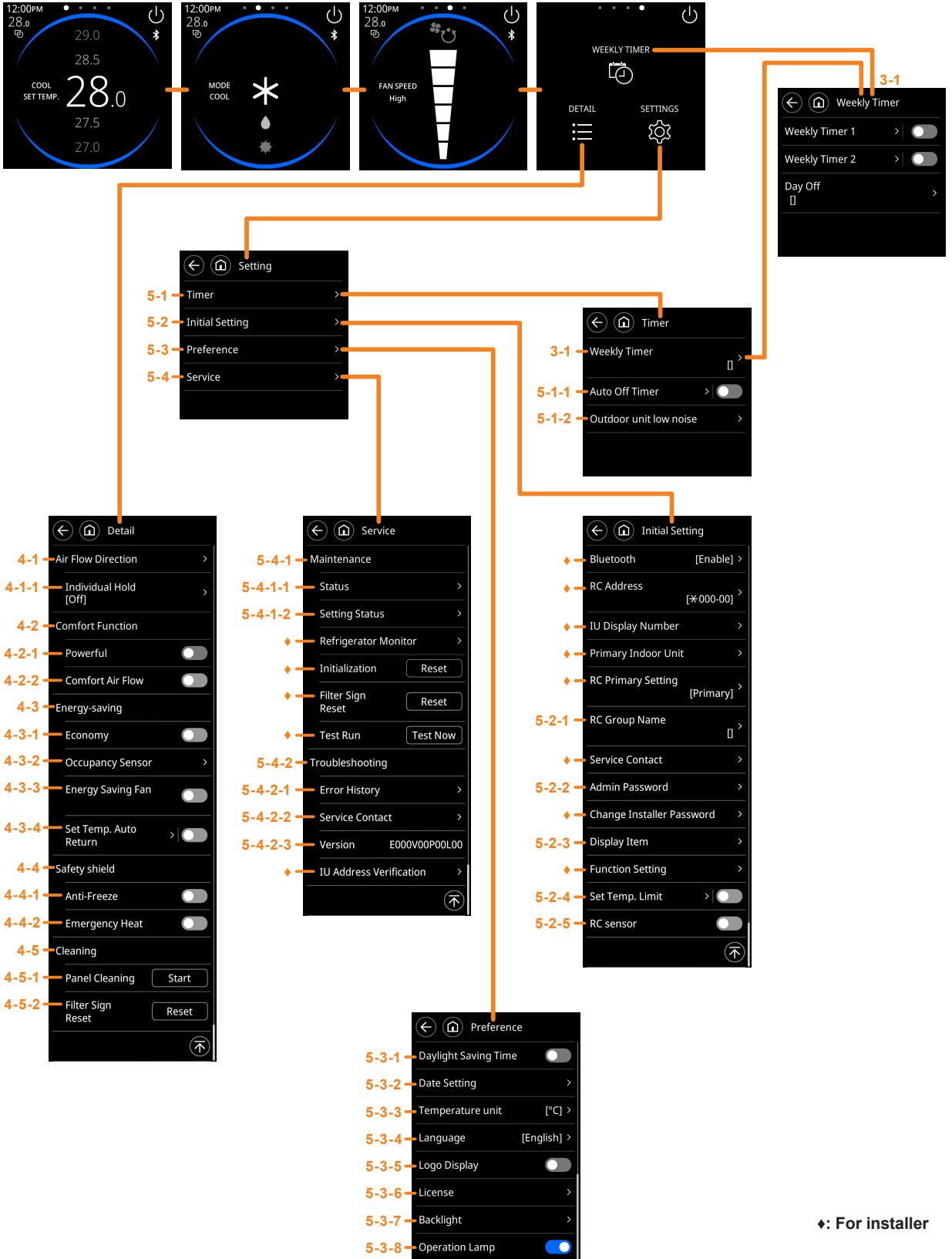

SIMPLIFIED EU/GB DECLARATION OF CONFORMITY

The simplified EU/GB Declaration of conformity referred to Article 10 (9) shall be provided as follows: Hereby, FUJITSU GENERAL LIMITED declares the radio equipment type UTY-RVRY/UTY-RVRG/UTY-RVRX complies with Directive 2014/53/EU.

The following items are available from our global site.

- Full text of the EU/GB Declaration of conformity
- Operation manual (full) (*1)

*1: Settings and specifications not described in the Operation manual (simple) are described in the Operation manual (full). Administrators are encouraged to refer to that manual as needed.
(Languages: En, De, Fr, Es, It, El, Pt, Tr, Ni, Pl)

www.fujitsu-general.com/global/support/



1 Introduction

1-1 Safety precautions

The "SAFETY PRECAUTIONS" indicated in the manual contain important information pertaining to your safety. Be sure to observe them.

 WARNING	This mark indicates procedures which, if improperly performed, might lead to the death or serious injury of the user.
In the event of a malfunction (burning smell, etc.), immediately stop operation, turn off the electrical breaker, and consult authorized service personnel.	
Do not repair or modify any damaged cable by yourself. Let the authorized service personnel to do it. Improper work will cause an electric shock or a fire.	
When moving, consult authorized service personnel for uninstallation and installation of this unit.	
Do not touch with wet hands. It may cause an electric shock.	
If children may approach the unit, take preventive measures so that they cannot reach the unit.	
Do not repair or modify by yourself. It may cause a fault or accident.	
Do not use flammable gases near the unit. It may cause a fire from leaking gas.	
Dispose of the packing materials safely. Tear and dispose of the plastic packing bags so that children cannot play with them. There is the danger of suffocation if children play with the original plastic bags.	
This appliance is not intended for use by persons (including children) with reduced physical, sensory or mental capabilities, or lack of experience and knowledge, unless they have been given supervision or instruction concerning use of the appliance by a person responsible for their safety. Children should be supervised to ensure that they do not play with the appliance.	

[Australian Battery Regulation]

THIS PRODUCT CONTAINS A RECHARGEABLE LITHIUM BUTTON BATTERY THAT IS SOLDERED IN PLACE.



If swallowed, the battery can cause severe or fatal injuries within 2 hours. Keep batteries out of reach of children (whether the battery is new or used). If you think batteries may have been swallowed or placed inside any part of the body, seek immediate medical attention.

 CAUTION	This mark indicates procedures which, if improperly performed, might possibly result in personal harm to the user or damage to property.
Do not set vessels containing a liquid on this unit. Doing so will cause heating, fire or electric shock.	
Do not expose this unit directly to water. Doing so will cause trouble, electric shock or heating.	
Do not place electrical devices within 1 m (40 in) of this unit. It may cause malfunction or failure.	
Do not use fire near this unit or place a heating apparatus nearby. It may cause malfunction.	
Do not touch the switches with sharp objects. Doing so will cause injury, trouble, or electric shock.	
Do not insert articles into the slit parts of this unit. Doing so will cause trouble, heating, or electric shock.	

1-2 System outline

1-2-1 Terminology

System related terms (◆ is for VRF system)

- VRF system ◆:
VRF (Variable Refrigerant Flow) is a large multi-split system that effectively air conditions a wide variety of spaces from large buildings to personal residences.
- Other system:
Multi-split or single-split type air conditioning system other than VRF system.
- Heat recovery system ◆:
The indoor unit connects to the outdoor unit via an RB unit in this system. RB units of single type and 4-system multi type are available. When a certain RB Group indoor units are performing cooling operation, other RB Group indoor units can perform heating operation. Refer to (e) for RB Group. An indoor unit connected to an outdoor unit without going through an RB unit are for cooling only.
- Heat pump system:
This is standard system. In this system, the indoor units cannot perform the cooling operation and the heating operation at the same time.
- RB Group [for heat recovery system] ◆:
A group of indoor units connected to a single type RB unit or each system of a multi type RB unit. In the RB Group, the indoor units cannot perform cooling operation and heating operation at the same time.
- R.C. Group (Remote Controller Group):
This forms a group by connecting indoor units by remote controller cable. One indoor unit which is ungrouped is an R.C. Group, too. It is the minimum unit of operation.
- Refrigeration system:
This is a system composed of indoor units and outdoor units connected by the same refrigerant piping.
- System ◆:
This is 1 or 2 or more refrigerant systems connected by the same transmission cable.

- (i) **Central controller ◆:**
A central remote controller can control multiple R.C. Groups. There is a system controller, Touch panel controller, and a central remote controller.
- (j) **Standard remote controller:**
A standard remote controller can control 1 R.C. Group only. This unit corresponds to this. This unit cannot be used together with a 3-wire wired remote controller. A wireless remote controller can be used together with this unit.

Address related terms

- (k) **Indoor unit address ◆:**
This is an ID individually assigned to each indoor unit.
- (l) **Remote controller address:**
This is an ID individually assigned separately from the indoor unit address to indoor units which form an R.C. Group.

1-2-2 Password configuration

This unit can set the following 2 kinds of passwords:

- (a) **Admin password**
This is a password for administrator. Password is requested by the setting which requires management. For a description of password setting and change, refer to [5 Setting] → [5-2 Initial Setting] → [5-2-2 Admin Password].
- (b) **Installer password**
This password is requested for important settings at installation.

NOTE

If you forget your password, contact your local dealer.

1-3 Name of parts

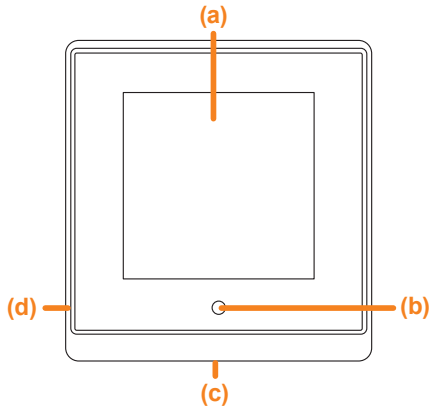

- (a) **Touch screen**
It can be operated by tapping or swiping.

NOTE

Operate with your finger or stylus pen (not included). Do not touch the screen with a hard or sharp object as it may cause a malfunction.

- (b) **Ambient light sensor**
Detects the brightness around the controller.

(c) Operation lamp

It lights up in a color according to the operation mode while indoor unit operating. Light goes out while stopped. Blinks when an error is detected.

Lighting color	Blue	Green	Red	Purple	White
Operation mode	Cool	Dry	Heat or 10°C (50°F) heat	Auto or Custom auto	Fan

NOTE

The operation lamp can be turned off at all times. For details, refer to "5-3-8 Operation Lamp".

(d) Room temperature sensor (inside)

Detects the temperature around the controller.

1-4 Before operation or setting

1-4-1 Wake the controller

If the standby screen is displayed, tap the screen to display the temperature setting screen (home screen).

1-4-2 Standby mode screen

The standby mode screen varies depending on the settings.

■ **Example of standby mode screen**

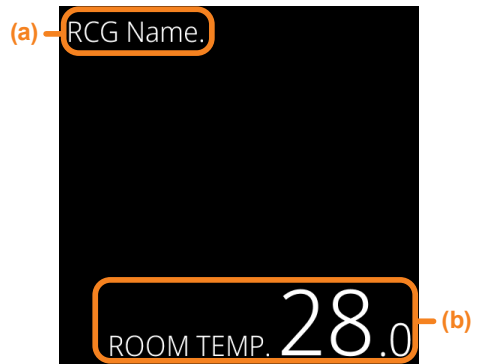

- (a) **Remote controller group name**
Appears when a name is set. Refer to "5-2-1 RC (Remote Controller) Group Name".
- (b) **Room temperature (Celsius or Fahrenheit)**

NOTES

- If there is no operation for a certain period of time, the controller display will disappear or the standby mode screen will be displayed.
- The standby mode screen is displayed when "5-3-7-3 Time after lighting" is set to "Dimming".
- The time until the standby mode can be set to 30 seconds, 60 seconds, 90 seconds, or 120 seconds. For details, refer to "5-3-7-4 Automatic Off Time".

1-4-3 Child safety lock

If you tap the screen and this screen is displayed, the child safety lock was set.

Release the child safety lock to operate or setting the controller.



■ Child safety lock set/release:

Press and hold the information area on the main screens for 5 seconds or longer to set/release the child safety lock.

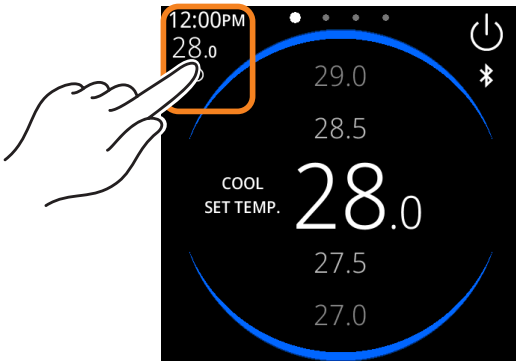

1-4-4 Password

■ Password screen

A password has been set for the items on which this screen is displayed. Check the password or operation permissions with the administrator.

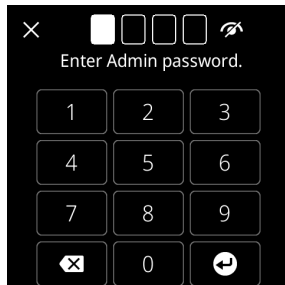

1-4-5 Message screen

The message screens have the following types.

■ Type of without buttons

It will close automatically when the process is completed.



■ Type of with "Cancel / OK" or "No / Yes" button

Tap [OK] or [Cancel] along the choice to close it.



■ Type of with "Close" button

After checking the contents, tap Close button to close it.

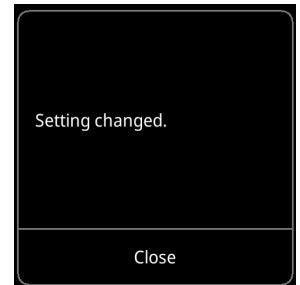

2 Basic operation

2-1 Main screen configuration

The main screen has 3 basic operation screens and 1 other setting screen.

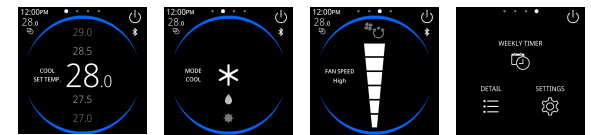

Room temp. Operation mode Fan speed Other settings

Swipe left or right to move between pages.

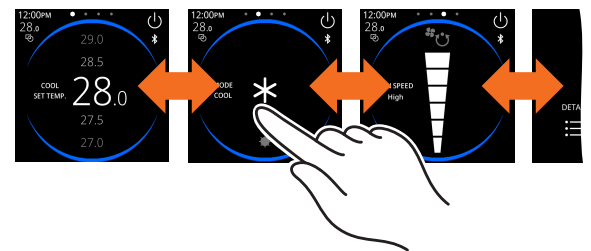

NOTE

Some screens may not be displayed depending on the settings.

2-1-1 Explanation of items common to the main screen.

■ Example of temperature setting screen

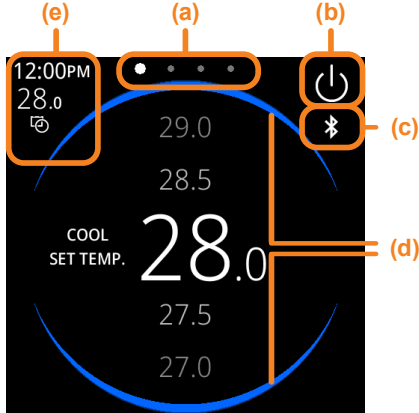





- (a) **Page indicator**
Shows the order of pages and the displayed page.
- (b) **Operation On/Off button**
Tap to operation start or stop the air conditioner.
- (c) **Bluetooth icon**
It will be displayed when Bluetooth is enabled.
This display is intended for installers and service personnel.
- (d) **Arc (operation indicator)**
It is displayed in a color according to the operation mode while indoor unit operating. Not displayed while stopped.

Arc color	Blue	Green	Red	Purple	White
Operation mode	Cool	Dry	Heat or 10°C (50°F) heat	Auto or Custom auto	Fan

- (e) **Information area**
The displayed contents differ depending on the screen and settings.
Tap here to move to the status screen. For details, refer to "5-4-1-1 Status"
When an error occurs, an error icon is displayed.

■ Status icons

-  The Weekly Timer is set.
-  The Auto Off Timer is set.
-  There are other settings.
-  The error occurred.

2-2 Operation On/Off

Tap Operation On/Off button to air conditioner On/Off.

■ Example of temperature screen

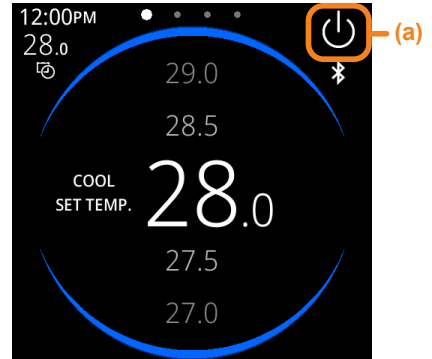

(a) Operation On/Off button

Tap to operation start or stop the air conditioner.

Operation on:

An arc appears on the screen and the operation lamp lights up. The color of the arc and operation lamp depends on the operation mode.

The operation lamp can be turned off at all times. For details, refer to "5-3-8 Operation Lamp".



Operation off:

The arc on the screen disappears and the operation lamp goes out.



2-3 Temperature setting

2-3-1 Temperature screen

This is the home screen of this product.

Example of cooling mode



Example of custom auto mode

NOTE

Depending on the indoor unit settings, [CUS. (Custom) AUTO] may be displayed instead of [AUTO].

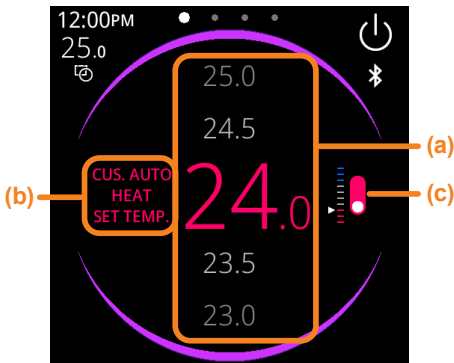

- (a) **Temperature setting area**
Swipe up or down to set the temperature.
- (b) **Operation mode**
The operation mode is displayed.
- (c) **Cooling/heating switching button**
Switches the cooling/heating temperature setting screen. Displayed only in custom auto mode.

NOTES

- The temperature unit, display color, and format vary depending on the settings and operation mode.
- When the operation mode is FAN, the temperature cannot be set.
- The temperature that can be set depends on the indoor unit model.

2-4 Operation mode setting





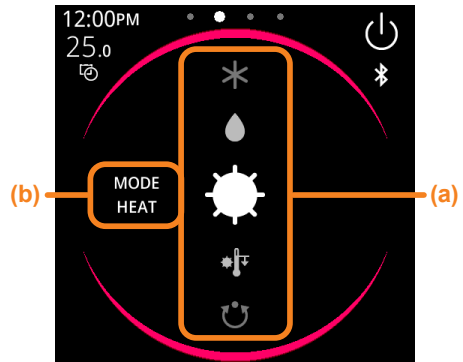

NOTE

The operation modes that can be set differ depending on the indoor unit model, air conditioner system, and controller settings.



- (a) **Operation mode setting area**
Swipe up or down to select the operation mode.
- (b) **Operation mode**
The operation mode is displayed.

Operation mode icons

COOL		DRY	
HEAT		10°C (50°F) HEAT	
AUTO or CUS. (Custom) AUTO		FAN	

2-5 Fan speed setting

NOTE

The fan speed that can be set depends on the indoor unit model, air conditioner system, or controller settings.

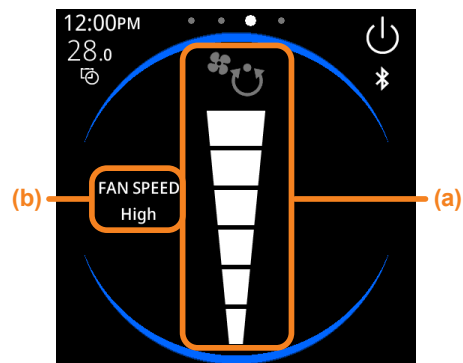

- (a) **Fan speed setting area**
Swipe up or down to set the fan speed.
[] is AUTO.
- (b) **Fan speed**
Displays the set fan speed.

3 Other settings

Other settings screen

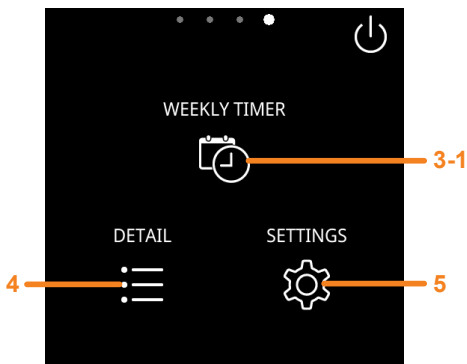

3-1 Weekly Timer

3-1-1 Weekly timer screen

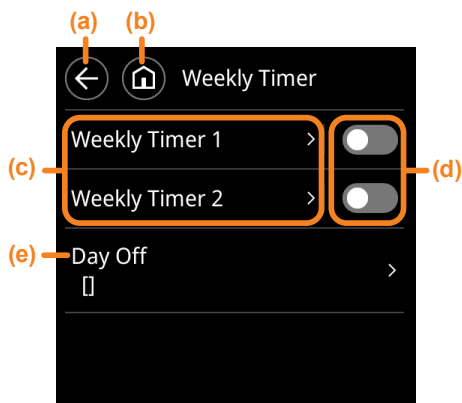

(a) back button

Tap to return to the previous screen.

(b) home button

Tap to move to the temperature setting screen (home screen).

(c) Weekly timer 1, 2

Weekly operation schedule can be set. Two schedule patterns can be created. Up to 8 times setting for each day can be set.

(d) Toggle button

Enables/disables the weekly timer. Weekly timer 1 and 2 cannot be enabled at the same time.

Enable



Disable



(e) Day off (refer to “3-1-8 Day Off screen”)

Set the day of the week of which Weekly Timer is to be temporarily disabled. When the set day has passed, the setting is cleared.

3-1-2 Day selection screen

Select the days of the week to create the schedule. You can copy the created schedule to other days of the week.

NOTE

The time format depends on the setting. Refer to “5-3-2-4 Time Format”.

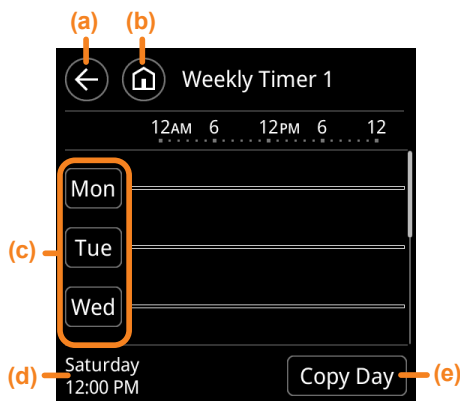

(a) Backward button

Tap to return to the previous screen.

(b) Home button

Tap to move to the temperature setting screen (home screen).

(c) Day selection menu

Tap to move to the “One day schedule setting screen”. Swipe up or down on this area to view days that are not visible. Refer to “3-1-3 One day schedule setting screen”.

(d) Clock

(e) Copy Day button

Tap here to start copying the created schedule for the day of the week.

3-1-3 One day schedule setting screen

Create a schedule for the day. Add events and set mode, temperature, time, and On/Off.

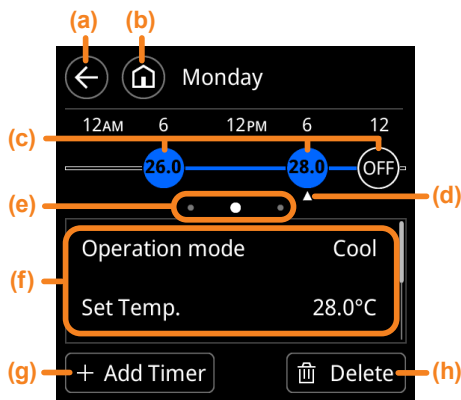

(a) Backward button

Tap to return to the previous screen.

(b) Home button

Tap to move to the temperature setting screen (home screen).







(c) Event icon

The icon display differs depending on the setting.

NOTE

Depending on the indoor unit settings, [Custom auto] may be displayed instead of [Auto].

■ Event icon example

Event icon	Detail		
	Icon color	Mode	Set temperature
	Blue	Cool	28.0°C
	Green	Dry	28.0°C
	Red	Heat or 10°C (50°F) heat	24.0°C
	Purple	Auto	26.0°C
	Blue and red	Custom auto	Cool: 28.0°C Heat: 23.0°C
	White	Fan	—
	Black	Operation stop	—

(d) Active marker

Appears on the icon that is selected or being set.

(e) Event selector

The same number of points as the icons are displayed at regular intervals. If the icons are overlapping and difficult to select, tap here.

(f) Setting menu

Set event details. Tap to move to each setting screen. Set the following items.

- Operation mode (refer to 3-1-4.)
- Set Temp. (refer to 3-1-5.)
- Time (refer to 3-1-6.)
- Operation Setting (refer to 3-1-7.)

(g) Add Event button

Tap here to create a new event or add one.

(h) Delete button

Tap here to delete the event with the active marker displayed.

3-1-4 Operation mode screen

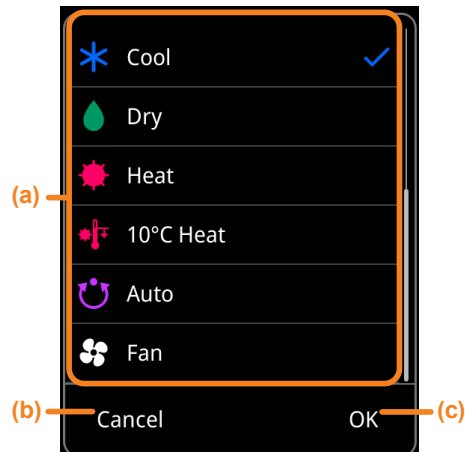

(a) Operation mode menu

Select and tap a operation mode. Swipe up or down on any hidden items.

NOTE

If set "3-1-7 Operation Setting screen" to "Off", do not need to set this item.

(b) Cancel button

Tap to display a confirmation screen. Tap [OK] on the confirmation screen to return to the previous screen.

(c) OK button

Tap to confirm the setting and return to the previous screen.

3-1-5 Set Temp. screen

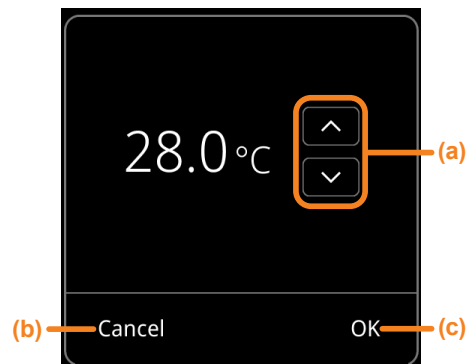

(a) Temperature setting button

Tap the button to set the temperature.

NOTES

- This item cannot be set when "10°C (50°F) heat" or "Fan" mode is selected in "3-1-4 Operation mode screen".
- If set "3-1-7 Operation Setting screen" to "Off", do not need to set this item.

(b) Cancel button

Tap to display a confirmation screen. Tap [OK] on the confirmation screen to return to the previous screen.

(c) OK button

Tap to confirm the setting and return to the previous screen.

3-1-6 Time screen

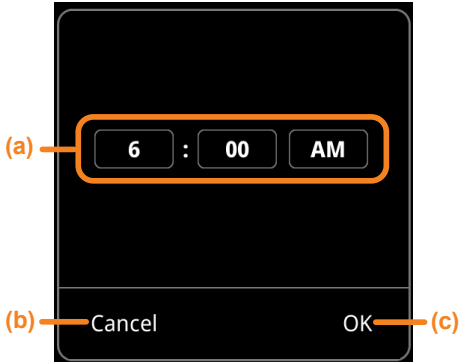

(a) Time setting button

When tap each item of "Hour", "Minute" and "AM/PM", each selection screen is displayed. Swipe up or down to select an item, and tap [X] above the item to confirm.

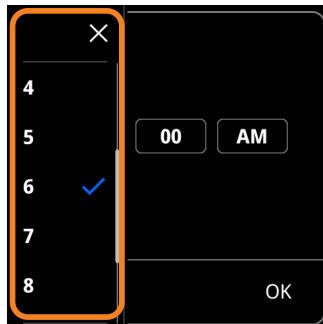

NOTE

The time format depends on the setting. Refer to "5-3-2-4 Time Format".

(b) Cancel button

Tap to display a confirmation screen. Tap [OK] on the confirmation screen to return to the previous screen.

(c) OK button

Tap to confirm the setting and return to the previous screen.

3-1-7 Operation Setting screen

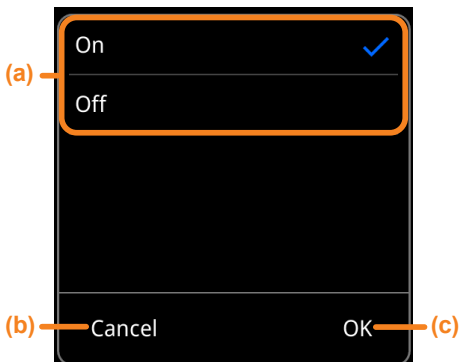

(a) Operation menu

Tap the button to set On/Off.

NOTE

If this item is set to "Off", the following items do not need to be set.

- Operation mode (refer to 3-1-4.)
- Set Temp. (refer to 3-1-5.)

(b) Cancel button

Tap to display a confirmation screen. Tap [OK] on the confirmation screen to return to the previous screen.

(c) OK button

Tap to confirm the setting and return to the previous screen.

3-1-8 Day Off screen

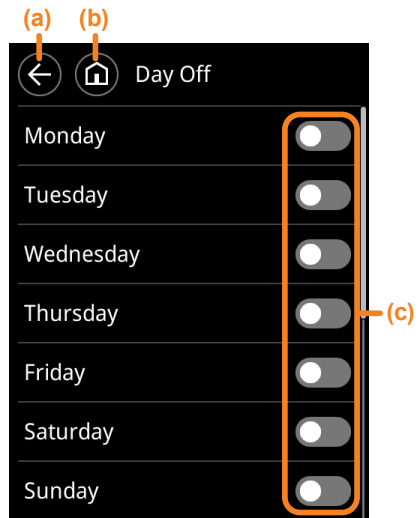

(a) Backward button

Tap to return to the previous screen.

(b) Home button

Tap to move to the temperature setting screen (home screen).

(c) Toggle button

Enable the days of the week when timer operation is not performed.

Enable



Disable



NOTE

This item is reset after the day of the week.

3-1-9 Create the schedule

■Select timer

Tap the timer (1 or 2) to create the schedule.

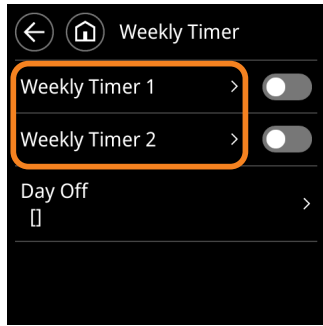

■Create a schedule for any day of the week

(1) Tap the day of the week to create the schedule.

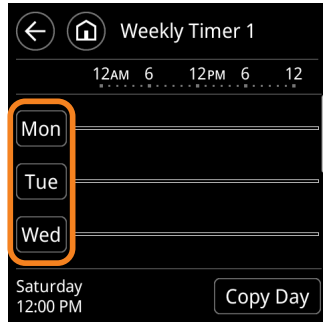

(2) Tap [+ Add Timer] to add an event.

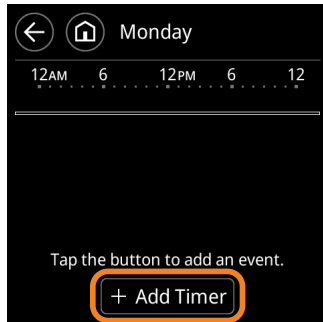

(3) Tap the following items of the added event to set them. Swipe up or down on items you cannot see.
 "Operation mode"
 "Set Temp."
 "Time"
 "Operation setting (On/Off)"

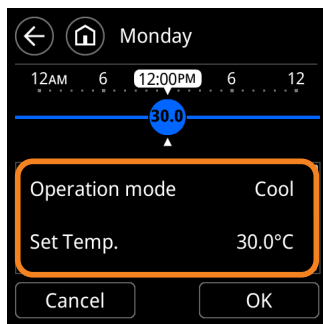

(4) When all settings are completed, tap [OK].

■Operation mode

* This item does not need to be set when operation Off.

- (1) Swipe up or down to select an operation mode, then tap.
- (2) Tap [OK].

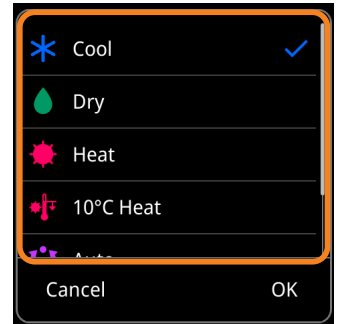

■Set Temp.

* This item does not need to be set when operation Off. And it cannot be set when "10°C (50°F) heat" or "Fan" mode is selected.

- (1) Set the temperature with [^] or [v].
- (2) Tap [OK].



■Time

* The display format of the time depends on the setting.

- (1) Tap the Hour, Minute, AM/PM (if available) item to select from the open list.
- (2) Tap [OK].

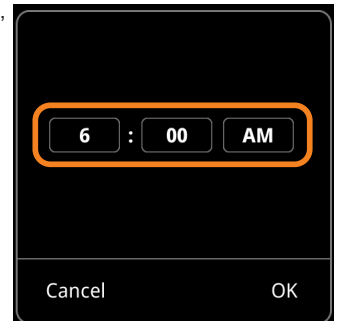

■Operation setting (On/Off)

- (1) Tap [On] or [Off].
- (2) Tap [OK].

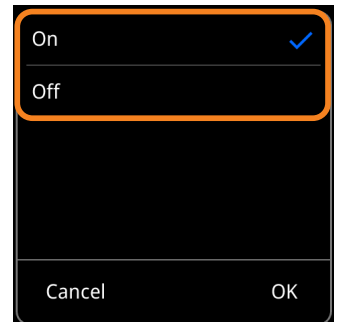

■Copy day

- (1) Tap [Copy Day].
- (2) Select the day of the week to copy.
- (3) Select the day of the week to paste.

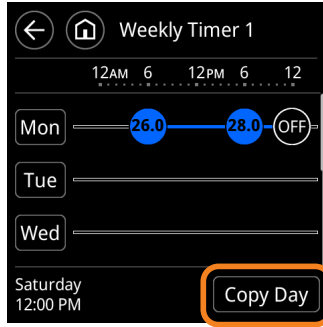

- (4) Tap [OK].

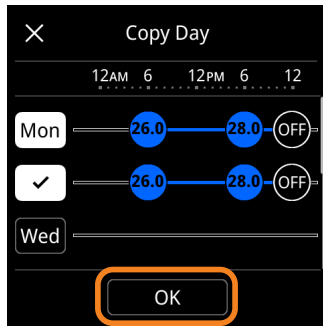

4 Detail

NOTE

Some items may not be displayed depending on the model of the indoor unit or the settings of the controller.

For each description, refer to the appropriate heading number.

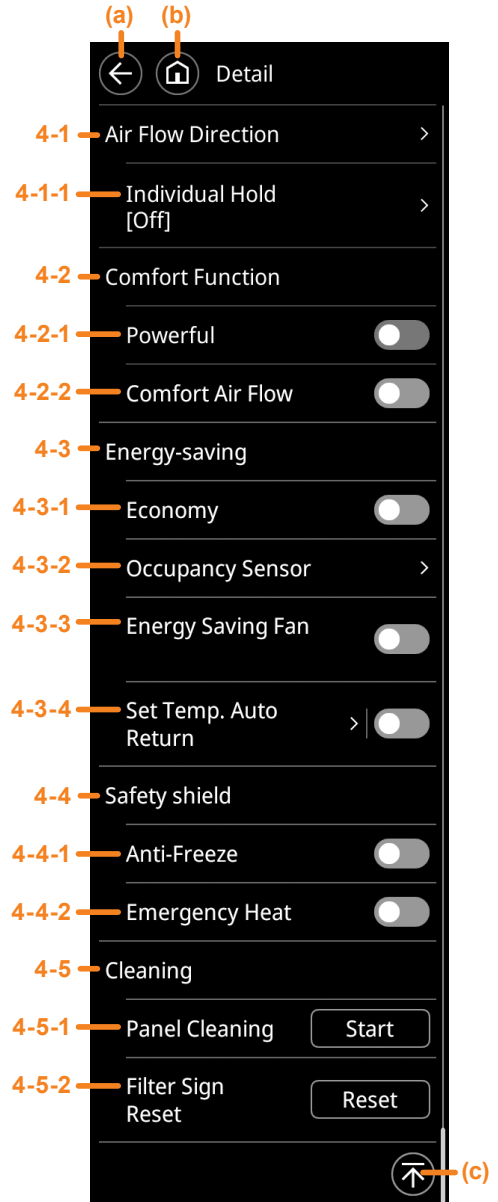

- (a) **Backward button**
Tap to return to the previous screen.
- (b) **Home button**
Tap to move to the temperature setting screen (home screen).
- (c) **Back to top button**
Tap to display the top of the scroll screen.

4-1 Air Flow Direction

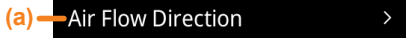

- (a) **Air flow direction menu**
Tap to move to the "Air Flow direction" screen.

NOTE

The setting screen differs depending on the type of indoor unit.

■ Up/down swing type

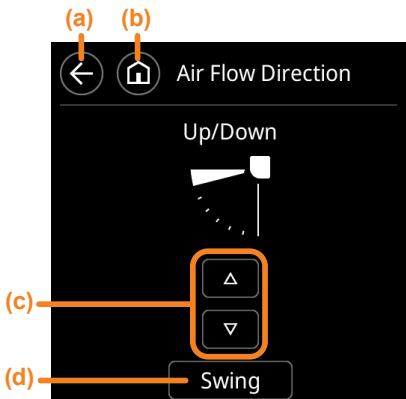

■ Up/down and left/right swing type

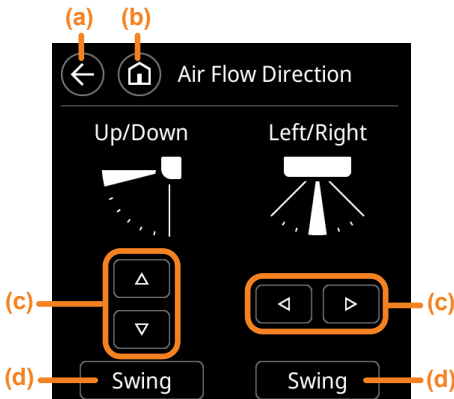

- (a) **Backward button**
Tap to return to the previous screen.
- (b) **Home button**
Tap to move to the temperature setting screen (home screen).
- (c) **Air flow direction adjust button**
Tap to adjust the air flow direction.
- (d) **Swing button**
Tap this button to swing. To release the swing, set the air flow direction.

4-1-1 Individual Hold

Individually set the airflow direction or swing for indoor units with multiple air outlets.

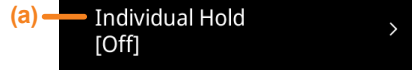

- (a) **Individual Hold menu**
Tap to move to the "Individual hold" screen.

NOTE

This function can only be used with compatible indoor units.

Step 1. Selecting the indoor unit to set

Tap the indoor unit to be set to move to the air outlet selection screen.

■ Individual Hold screen (indoor unit list)

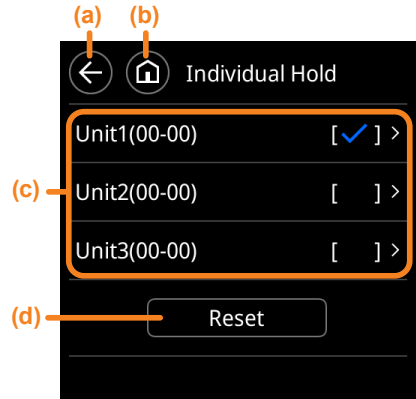

- (a) **Backward button**
Tap to return to the previous screen.
- (b) **Home button**
Tap to move to the temperature setting screen (home screen).
- (c) **Indoor unit list**
Tap the indoor unit to be set to move to the air outlet selection screen. The indoor units that have already been set have a blue check mark. Go to Step 2. Selecting the air outlet to set.

NOTE

The number of indoor units displayed varies depending on the system.

- (d) **Reset button**
Tap to initialize all settings on this screen.

Step 2. Selecting the air outlet to set

Tap the air outlet to be set to move to the airflow direction screen.

■ Unit screen (air outlet selection)

Cassette type

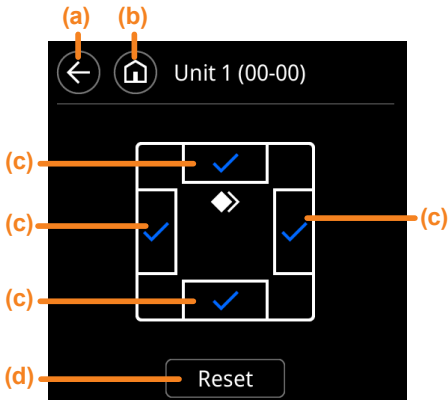

(a) Backward button

Tap to return to the previous screen. When setting the other indoor unit, tap this button.

(b) Home button

Tap to move to the temperature setting screen (home screen).

(c) Air outlet select button

Tap the air outlet to be set to move to the airflow direction screen. The air outlets that have already been set have a blue check mark. Go to Step 3. Airflow direction or swing setting.

(d) Reset button

Tap to initialize all settings on this screen.

Step 3. Airflow direction or swing setting

Tap to adjust the airflow direction.

■ Outlet screen (adjust airflow direction)

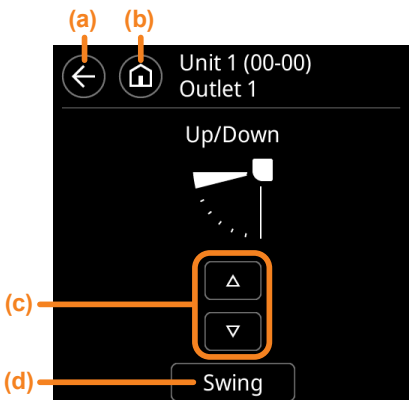

(a) Backward button

Tap to return to the previous screen. When setting the other air outlet, tap this button.

(b) Home button

Tap to move to the temperature setting screen (home screen).

(c) Airflow direction adjust button

Tap to adjust the airflow direction.

(d) Swing button

Tap [Swing] to swing. To release the swing, set the airflow direction.

4-2 Comfort Function

4-2-1 Powerful

In the Powerful operation, the air conditioner will operate at maximum power and strong airflow to cool down or warm up the room quickly.



(a) Toggle button

Tap to toggle enable/disable.

Enable



Disable



NOTE

Powerful operation ends automatically and switches to normal operation. For details, refer to the operation manual of the indoor unit.

4-2-2 Comfort Air Flow

It automatically adjusts the direction of the wind to deliver airflow throughout the room.



(a) Toggle button

Tap to toggle enable/disable.

Enable



Disable



4-3 Energy-saving

4-3-1 Economy

Reduces power consumption by operating with reduced capacity.



(a) Toggle button

Tap to toggle enable/disable.

Enable



Disable



4-3-2 Occupancy Sensor



(a) Backward button

Tap to return to the previous screen.

(b) Home button

Tap to move to the temperature setting screen (home screen).

4-3-2-1 Auto Saving

When the absence continues for the set time, the operation switches to energy saving operation.

If no one enters the room during the set time (15, 30, 60, 90, 120, 180 minutes), the set temperature will be automatically controlled.

(When someone comes back into the room, the human sensor will detect this, and automatically revert to the original settings.)

NOTE

For details of Auto Saving, refer to the operation manual of the indoor unit.

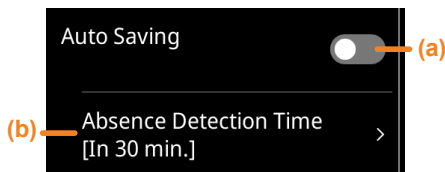

(a) Toggle button

Tap to toggle enable/disable.



(b) Set time menu

Tap the "Absence Detection Time" and set the time.

- (1) Swipe up or down to select the detection time and tap it.
- (2) Tap [⏪] to return to the previous screen.

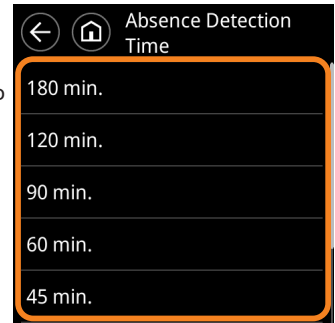

4-3-2-2 Auto Off

When the absence continues for the set time, indoor unit operation stops.

If no one enters the room during the set time (1 to 24 hours in 1 hour increments), the air conditioner will automatically stop operation.

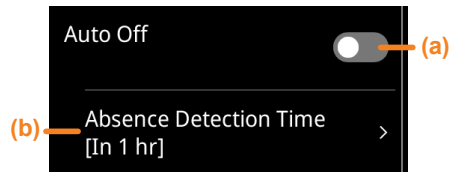

(a) Toggle button

Tap to toggle enable/disable.



(b) Set time menu

Tap the "Absence Detection Time" and set the time.

- (1) Swipe up or down to select the detection time and tap it.
- (2) Tap [⏪] to return to the previous screen.



4-3-2-3 Auto On/Off

When the absence continues for the set time, indoor unit operation stops, and resumes operation when a person is detected.

If no one enters the room during the set time (15, 30, 60, 90, 120, 180 minutes), the air conditioner will automatically stop operation.

(When someone comes back into the room, the human sensor will detect this, and automatically revert to the original settings.)

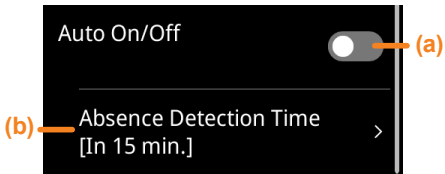

(a) Toggle button

Tap to toggle enable/disable.



(b) Set time menu

Tap the "Absence Detection Time" and set the time.

- (1) Swipe up or down to select the detection time and tap it.
- (2) Tap [⏪] to return to the previous screen.

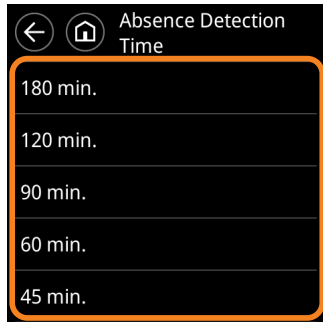

4-3-3 Energy Saving Fan

When the set temperature is reached during cooling operation, the fan operates intermittently and power is saved.

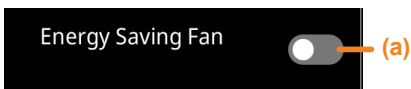

(a) Toggle button

Tap to toggle enable/disable.



4-3-4 Set Temp. Auto Return

Even if the temperature setting is changed during Cool or Heat mode operation, after the set time, the temperature automatically returns to the set temperature.

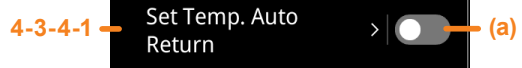

(a) Toggle button

Tap to toggle enable/disable.



4-3-4-1 Set Temp. Auto Return (settings menu)

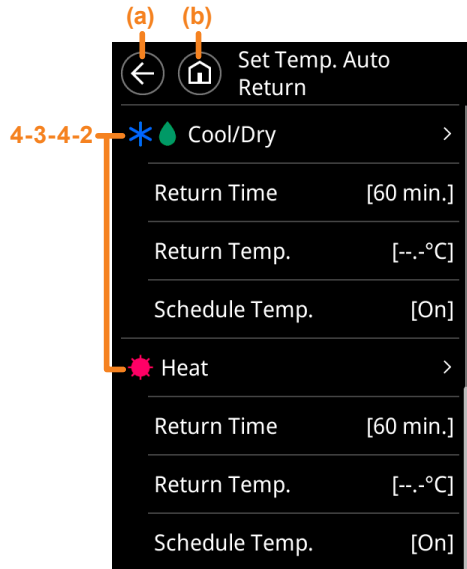

(a) Backward button

Tap to return to the previous screen.

(b) Home button

Tap to move to the temperature setting screen (home screen).

4-3-4-2 Cool/Dry or Heat (setting)

NOTE

The setting method for Cool/Dry and Heat is the same.

■ Example of the Cool/Dry screen

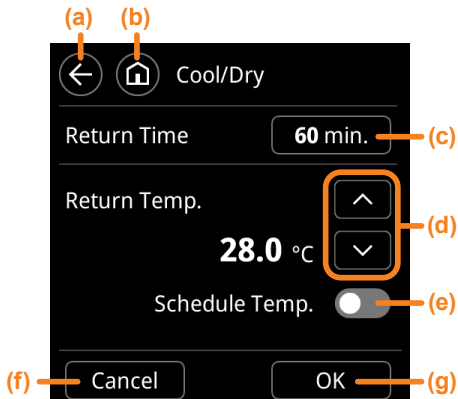

(a) Backward button

Tap to return to the previous screen.

(b) Home button

Tap to move to the temperature setting screen (home screen).

(c) Return time setting button

Tap to select a time from the pull-down menu. It can be set in units of 10 minutes in the range of 10 to 240 minutes. To close the pull-down menu, tap [X] at the top.

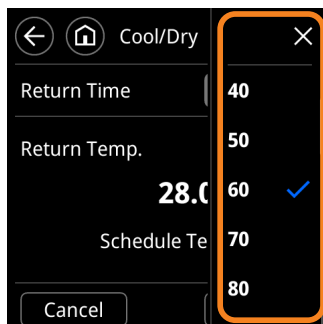

(d) Return temperature setting button

Tap to set the return temperature. This setting is not necessary if the return temperature is set to the weekly timer setting.

(e) Schedule temperature toggle button

When enabled, the return temperature will be the weekly timer setting. To use this function, need to set the weekly timer.



(f) Cancel button

Tap to display a confirmation screen. Tap [OK] on the confirmation screen to return to the previous screen.

(g) OK button

Tap to confirm the setting and return to the previous screen. When the settings are changed, a confirmation screen will be displayed. Tap [OK] on the confirmation screen to return to the previous screen.

4-4 Safety shield

4-4-1 Anti-Freeze

Anti-Freeze is a function that performs low temperature heating operation to prevent freezing of water lines and equipment, when air conditioning operation is off, in regions where outside temperature may drop below freezing.

NOTE

If water lines are far from the unit or within exterior walls, this function may not provide enough anti freeze protection.



(a) Toggle button

Tap to toggle enable/disable.



4-4-2 Emergency Heat

Auxiliary heater will be primary heater, and the outdoor unit will stop.

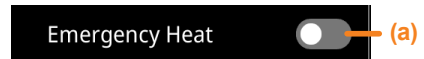

(a) Toggle button

Tap to toggle enable/disable.



4-5 Cleaning

4-5-1 Panel Cleaning

Operation is prohibited for 30 seconds to prevent erroneous operation due to cleaning.

NOTE

When cleaning the touch screen panel, wipe with a soft and dry cloth. Do not use water, harsh abrasive cleansers, or volatile agents like benzene or thinner.



(a) Start button

When tap [Start], the display panel will not respond to wiping for 30 seconds.

4-5-2 Filter Sign Reset

After cleaning the filter, reset the filter sign.



(a) Reset button

Tap [Reset] to reset the filter sign.

5 Setting

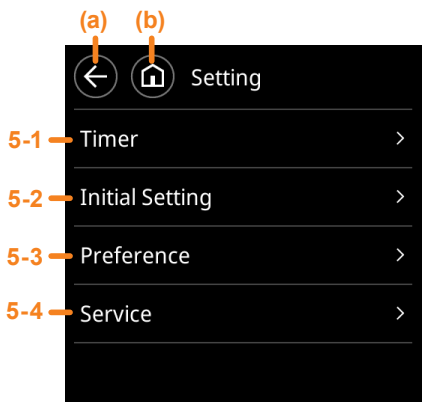

(a) Backward button

Tap to return to the previous screen.

(b) Home button

Tap to move to the temperature setting screen (home screen).

5-1 Timer

NOTE

Some items may not be displayed depending on the model of the indoor unit or the settings of the controller.

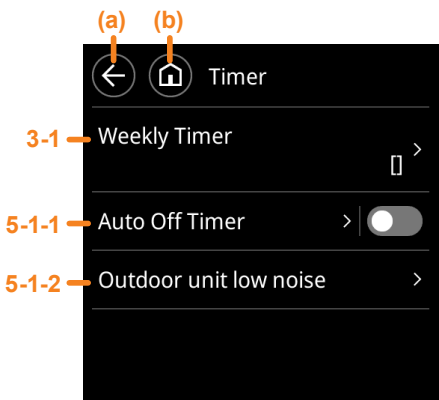

(a) Backward button

Tap to return to the previous screen.

(b) Home button

Tap to move to the temperature setting screen (home screen).

5-1-1 Auto Off Timer

When indoor unit operation is started by the Operation button of this unit, operation stops after the set time.

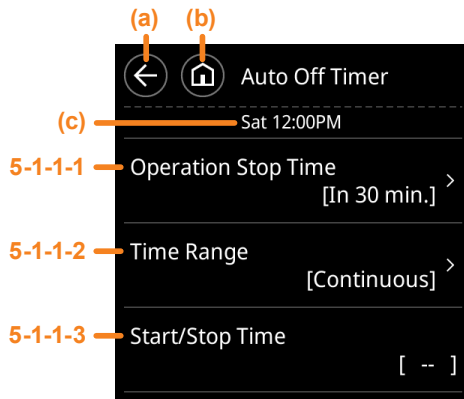

(a) Backward button

Tap to return to the previous screen.

(b) Home button

Tap to move to the temperature setting screen (home screen).

(c) Clock

5-1-1-1 Operation Stop Time

Set the time from operation start to automatic stop.

- Swipe up or down to select the stop time and tap it.
Set in 10 minute increments from 30 minutes to 240 minutes.
- Tap [←] to return to the previous screen.

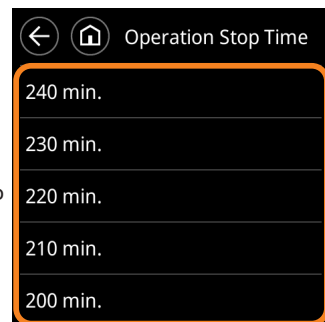

5-1-1-2 Time Range

- When specifying a time range for the "Auto Off Timer", tap [Range Spec.] and when enabling the setting all day, tap [Continuous].
- Tap [←] to return to the previous screen.

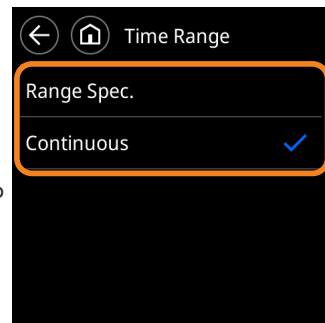

If selected [Range Spec.] here, specify the range in "5-1-1-3 Start/Stop Time".

5-1-1-3 Start/Stop Time

If [Range Spec.] is selected in "5-1-1-2 Time Range", specify the range here.

NOTE

The display format of the time varies depending on the settings.

- (1) Set the start time and stop time.
- (2) Tap [OK] to return to the previous screen.

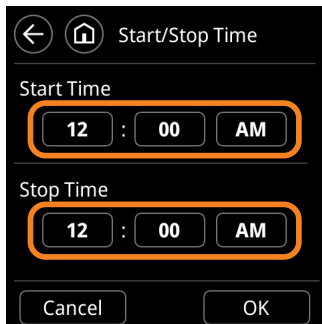

5-1-2-2 Time Range

- (1) When specifying a time range for the "Outdoor unit low noise", tap [Range Spec.] and when enabling the setting all day, tap [Continuous].
- (2) Tap [←] to return to the previous screen.

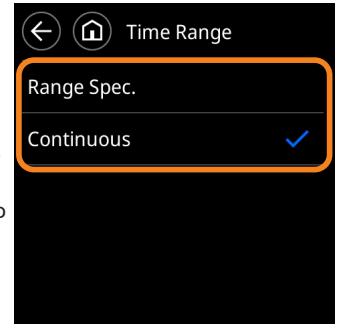

If selected [Range Spec.] here, specify the range in "5-1-1-3 Start/Stop Time".

5-1-2-3 Start/Stop Time

If [Range Spec.] is selected in "5-1-1-2 Time Range", specify the range here.

NOTE

The display format of the time varies depending on the settings.

- (1) Set the start time and stop time.
- (2) Tap [OK] to return to the previous screen.

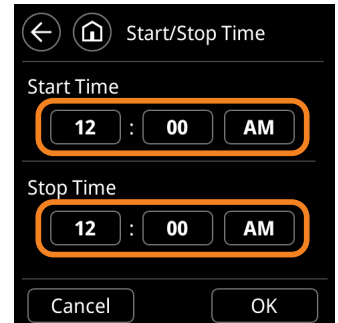

5-1-2 Outdoor unit low noise

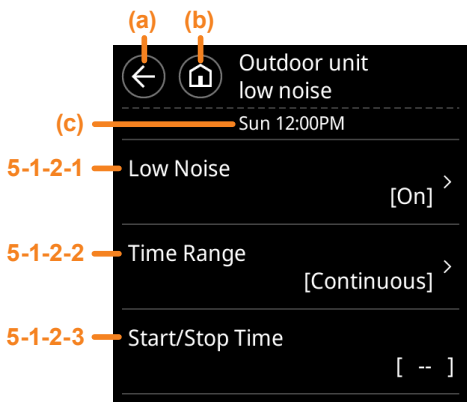

- Backward button**
Tap to return to the previous screen.
- Home button**
Tap to move to the temperature setting screen (home screen).
- Clock**

5-1-2-1 Target outdoor unit selection

Specify the outdoor unit for low noise operation.

- (1) To set all outdoor units collectively, tap [Group Setting] and tap [All on] or [All off].
When setting individually, use the toggle button for each outdoor unit.

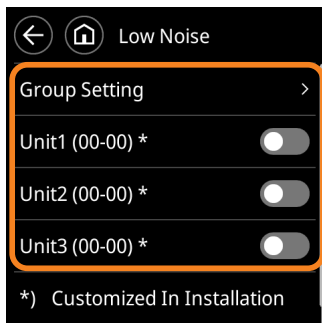
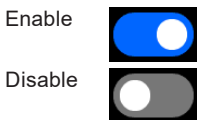

- (2) Tap [←] to return to the previous screen.

5-2 Initial Setting

NOTE

Some items may not be displayed depending on the model of the indoor unit or the settings of the controller.

For each description, refer to the appropriate heading number.

◆: For installer

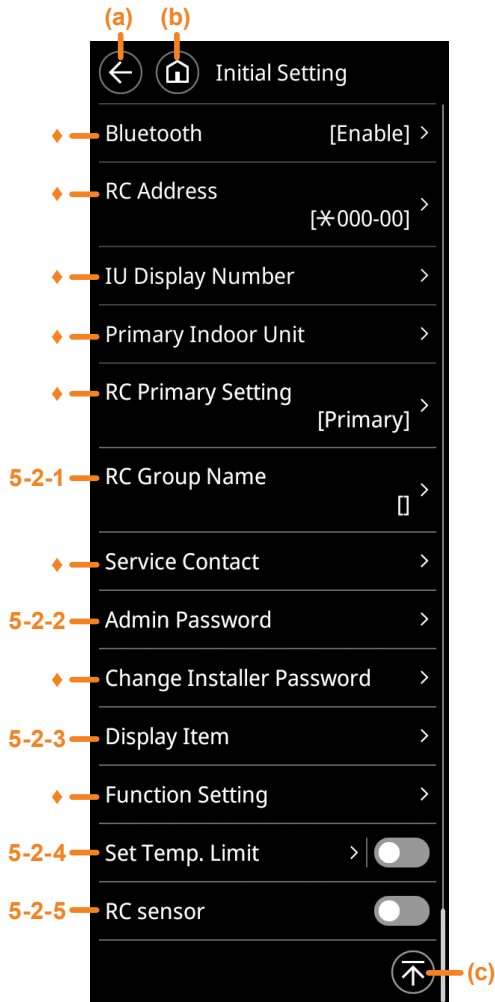

(a) Backward button

Tap to return to the previous screen.

(b) Home button

Tap to move to the temperature setting screen (home screen).

(c) Back to top button

Tap to display the top of the scroll screen.

5-2-1 RC (Remote Controller) Group Name

The remote controller group name can be set or changed.

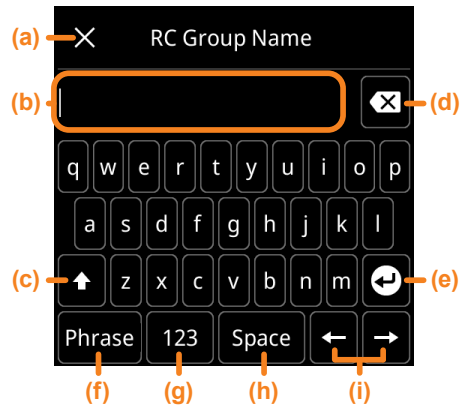

(a) Cancel button

Tap to display a confirmation screen. Tap [OK] to cancel the settings and return to the previous screen.

(b) Input area

Up to 12 characters can be entered.

(c) Shift key

(d) Backspace key

(e) Enter key

(f) Phrase key

[Floor, Corridor, Office, Conf Room, Recept Room, Room, Room No., Front, Side, Entrance, Outlet, East, West, South, North, Window] are registered. Tap the [Phrase] key until the sentence to be used is displayed.

NOTE

If tap the [Phrase key] during input, the input up to that point will be deleted. If add characters to phrase, enter phrase first.

(g) 123 key

Tap to display numbers and symbols. Tap again to restore.

(h) Space key

(i) Cursor keys

- (1) After entering, tap [OK] to display the confirmation screen.
- (2) Tap [Close] to return to the previous screen.

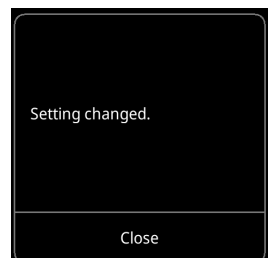

5-2-2 Admin Password

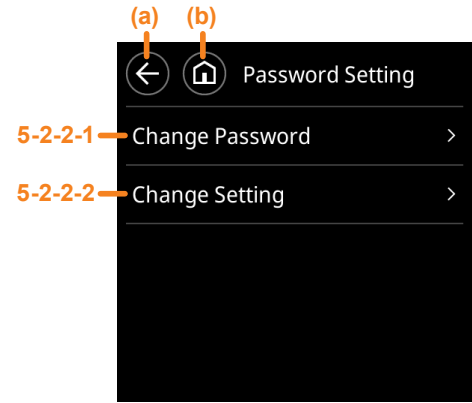

5-2-2-1 Change Password

The admin password setting and changes can be performed. Tap [🔑] to display the entered number.

- (1) Enter current password and tap [🔑].

When make a mistake, tap [✖].

The default password is "0000" (4 digits).

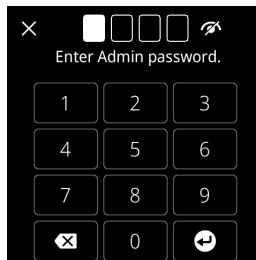

- (2) Enter new password and tap [🔑].

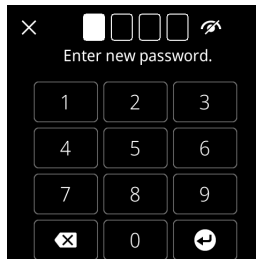

- (3) A confirmation screen will be displayed, so tap [OK].

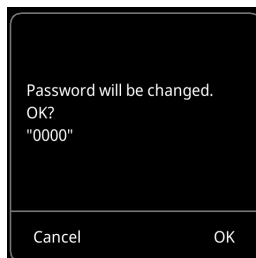

- (4) Tap [Close] to return to the previous screen.



5-2-2-2 Change Setting

NOTE

Some items may not be displayed depending on the model of the indoor unit or the settings of the controller.

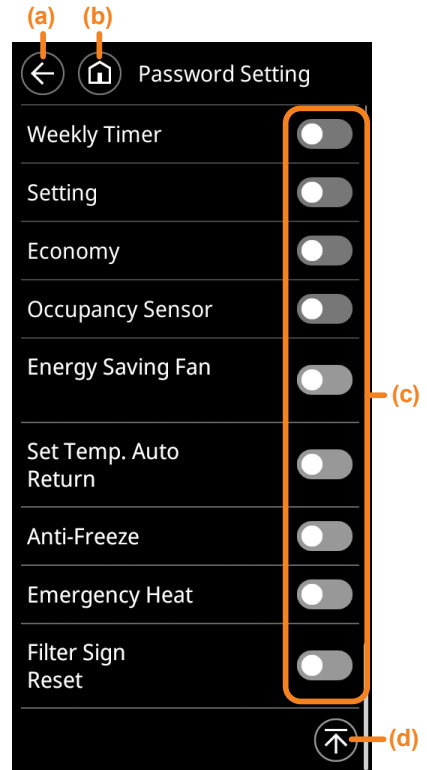

(a) Backward button

Tap to return to the previous screen.

(b) Home button

Tap to move to the temperature setting screen (home screen).

(c) Toggle button

Enable the item that requires an administrator password.

Enable



Disable



(d) Back to top button

Tap to display the top of the scroll screen.

5-2-3 Display Item

NOTE

Some items may not be displayed depending on the model of the indoor unit or the settings of the controller.

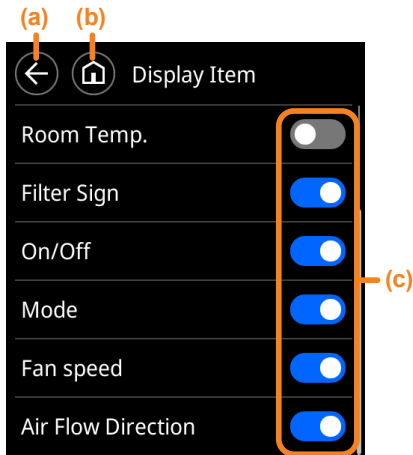

(a) Backward button

Tap to return to the previous screen.

(b) Home button

Tap to move to the temperature setting screen (home screen).

(c) Toggle button

Enable the items to be displayed on the screen.



5-2-4 Set Temp. Limit

Power consumption by excessive temperature setting is suppressed by restricting the temperature setting range for each operation mode of Cool/Dry, Heat, or Auto.

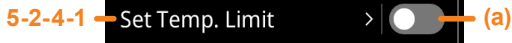

(a) Toggle button

Tap to toggle enable/disable.



5-2-4-1 Set Temp. Limit (settings menu)

NOTE

Some items may not be displayed depending on the model of the indoor unit.

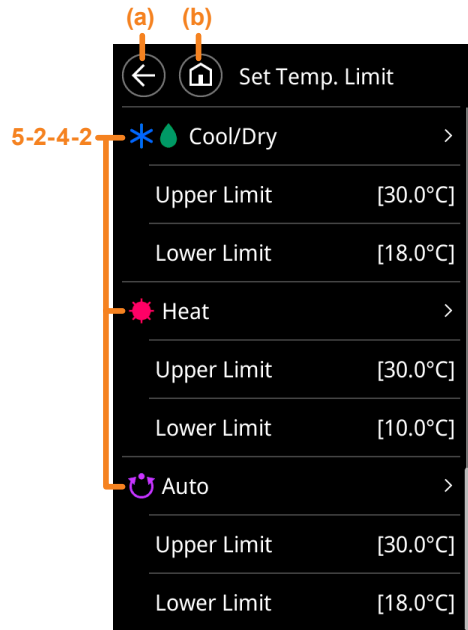

(a) Backward button

Tap to return to the previous screen.

(b) Home button

Tap to move to the temperature setting screen (home screen).

5-2-4-2 Limit of Cool/Dry, Heat or Auto

NOTE

The setting method for Cool/Dry and Heat is the same.

■ Example of the Limit of Cool/Dry screen

- Set the upper and lower temperature limits.
- Tap [OK] to return to the previous screen.

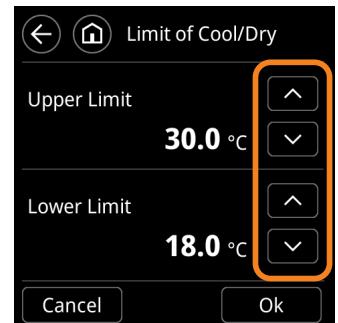

5-2-5 RC (Remote Controller) Sensor

This setting uses the sensor of this unit to sense the room temperature. The room temperature can be sensed at a position, closer to the person than the indoor unit sensor. Factory settings is "Disable".



(a) Toggle button

Tap to toggle enable/disable.



5-3 Preference

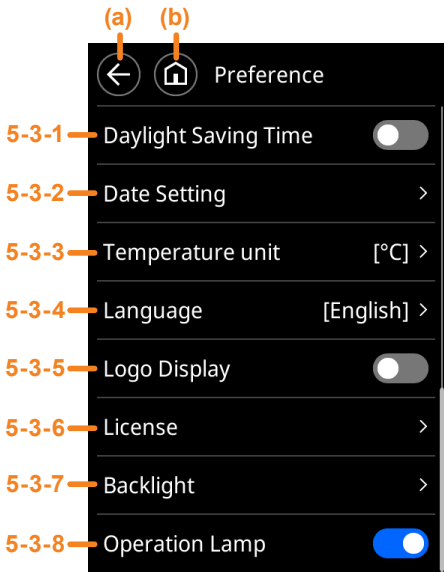

(a) Backward button

Tap to return to the previous screen.

(b) Home button

Tap to move to the temperature setting screen (home screen).

5-3-1 Daylight Saving Time (Summer time)

Tap to toggle enable/disable.



5-3-2 Date Setting

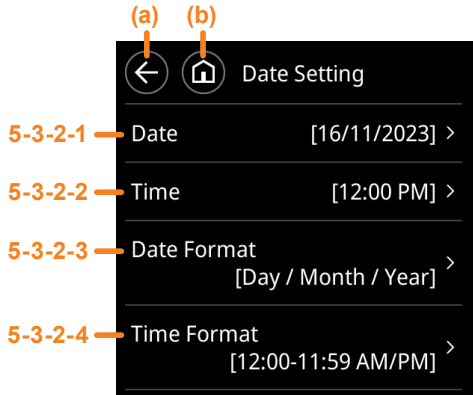

(a) Backward button

Tap to return to the previous screen.

(b) Home button

Tap to move to the temperature setting screen (home screen).

5-3-2-1 Date

Set the current date.

NOTE

The display format depends on the setting.

- (1) Tap the item to set.

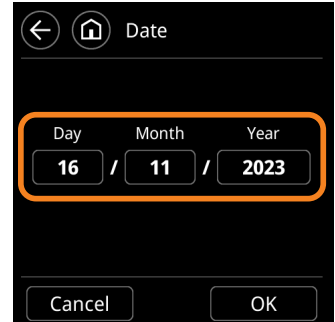

- (2) Swipe up or down on the expanded item to select a value.
- (3) Tap [X] at the top of the screen to confirm the value.
- (4) After setting each item, tap [OK] to return to the previous screen.

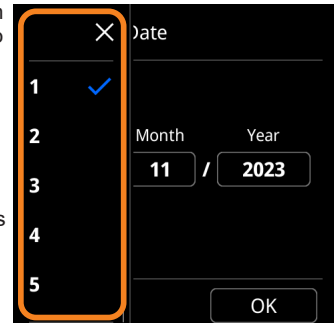

5-3-2-2 Time

Set the current time.

NOTE

The display format depends on the setting.

- (1) Tap the item to set.

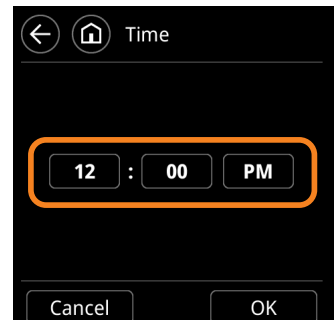

- Swipe up or down on the expanded item to select a value.
- Tap [X] at the top of the screen to confirm the value.
- Tap [OK] to return to the previous screen.

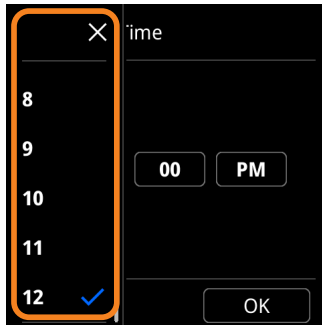

5-3-2-3 Date Format

- Tap the date format to use.
- Tap [←] to return to the previous screen.

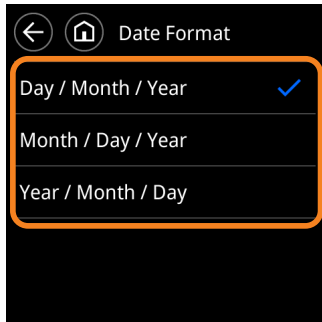

5-3-2-4 Time Format

- Tap the time format to use.
- Tap [←] to return to the previous screen.

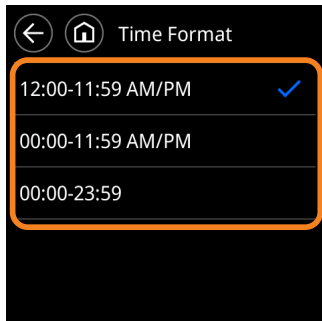

5-3-3 Temperature unit

- Tap the temperature unit to use.
- Tap [←] to return to the previous screen.

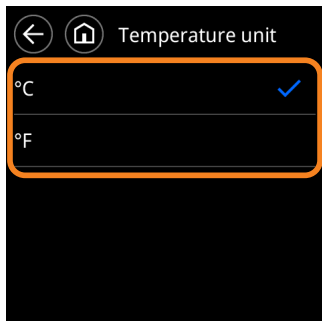

5-3-4 Language

- Tap the language to use.
- Tap [←] to return to the previous screen.



5-3-5 Logo Display

Display a registered image in standby mode. (Only if an image is registered during installation with AIRSTAGE Remo Set App.) Set "Time after lighting" (refer to 5-3-7-3) to "Dimming".



(a) Toggle button

Tap to toggle enable/disable.

Enable



Disable



NOTE

If want to register an image after installation or change a registered image, consult with an authorized service personnel.

5-3-6 License

- Swipe up and down to move the screen.
- Tap [←] to return to the previous screen.



5-3-7 Backlight

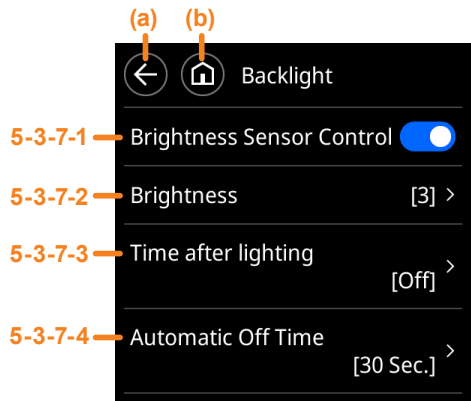

(a) Backward button

Tap to return to the previous screen.

(b) Home button

Tap to move to the temperature setting screen (home screen).

5-3-7-1 Brightness Sensor Control

Automatically adjusts the brightness of the screen according to the brightness of the room.



(a) Toggle button

Tap to toggle enable/disable.

Enable: The backlight is controlled according to the ambient brightness detected by the ambient light sensor on this controller.



Disable: Conforms to the "5-3-7-2 Brightness" (refer to 5-3-7-2) setting.



5-3-7-2 Brightness

- (1) Tap the brightness to use.
- (2) Tap [⏪] to return to the previous screen.

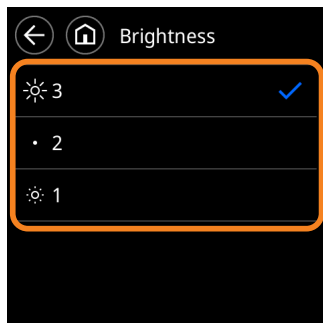

5-3-7-3 Time after lighting

Select whether to off or dim the backlight after operating this remote controller.

Off:	After the time set in "Automatic Off Time" (refer to 5-3-7-4) has passed, the backlight will turn off.
Dimming:	After the time set in "Automatic Off Time" (refer to 5-3-7-4) has passed, the brightness of the backlight will be reduced and one of the following will be displayed: <ul style="list-style-type: none"> • Display a registered image. (Only if an image was registered during installation.) Set "Logo Display" (refer to 5-3-5) to "Enable". • Display the standby mode screen. (refer to 1-4-2)

NOTE

To prevent screen burn-in, it turns off once every 30 minutes.

- (1) Tap the item to use.
- (2) Tap [⏪] to return to the previous screen.

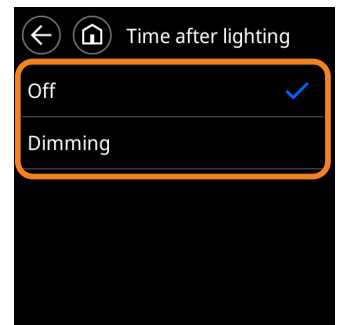

5-3-7-4 Automatic Off Time

Sets the time until the backlight turns off or dims.

- (1) Tap the time to use.
- (2) Tap [⏪] to return to the previous screen.

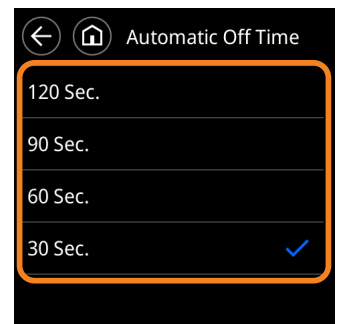

5-3-8 Operation Lamp

Sets the behavior of the operation lamp. For the operation lamp, refer to "1-3 Name of parts".



(a) Toggle button

Tap to toggle ON/OFF.

ON: The operation lamp lights up while the indoor unit is operating and goes out while it is stopped.



OFF: The operation lamp is always goes out.



5-4 Service

This function is for administrator and service personnel.

NOTE

Some items may not be displayed depending on the model of the indoor unit or the settings of the controller.

For each description, refer to the appropriate heading number.

◆: For installer

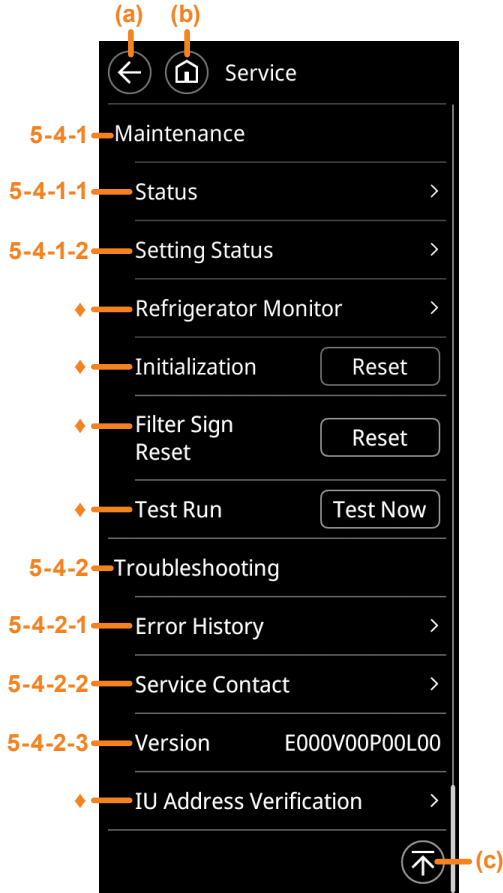

(a) Backward button

Tap to return to the previous screen.

(b) Home button

Tap to move to the temperature setting screen (home screen).

(c) Back to top button

Tap to display the top of the scroll screen.

5-4-1 Maintenance

5-4-1-1 Status

- (1) Swipe up and down to move the screen. To check the error that has occurred, tap [Error Information].
- (2) Tap [←] to return to the previous screen.

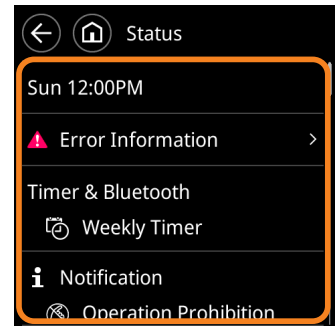

5-4-1-2 Setting Status

- (1) Swipe up and down to move the screen.
- (2) Tap [←] to return to the previous screen.

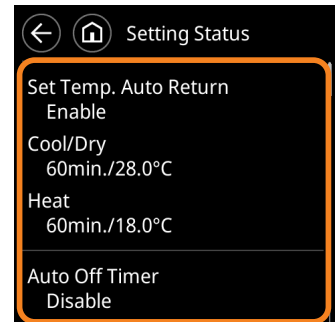

5-4-2 Troubleshooting

5-4-2-1 Error History

- (1) Swipe up and down to move the screen. To erase the error history, tap [Erase All].
- (2) Tap [←] to return to the previous screen.

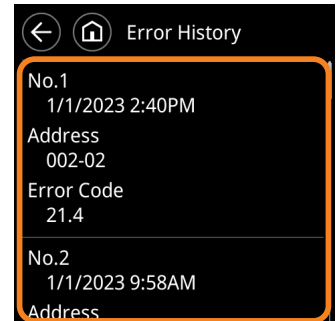

5-4-2-2 Service Contact

- (1) Tap [←] to return to the previous screen.

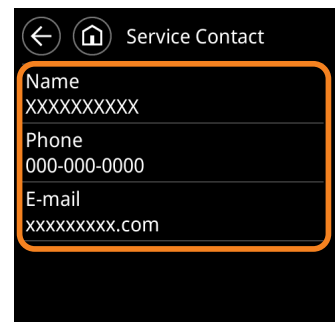

5-4-2-3 Version

The software version of this controller is displayed on the right.



6 Operation tips

6-1 Selectable Modes (for VRF system)

There are restrictions on the selectable modes depending on the system configuration and operation status.

6-1-1 Heat recovery system

- (a) When single indoor unit connected to RB unit All the modes can be selected.
- (b) When a master indoor unit is set in an RB group, only the mode selected at the master indoor unit (*1) can be used. (*1: "Fan" cannot be selected at the indoor unit including the master indoor unit.)
- (c) When a master indoor unit is not set in the RB Group, refer to the following table.

Status	Selectable	Not selectable
Other indoor unit is in cooling operation.	Cool, Dry	Auto or Custom auto, Heat, Fan
Other indoor unit is in dehumidifying operation.	Cool, Dry	Auto or Custom auto, Heat, Fan
Other indoor unit is in heating operation.	Heat	Auto or Custom auto, Cool, Dry, Fan
Other indoor unit is in anti freeze operation.	Heat	Auto or Custom auto, Cool, Dry, Fan

6-1-2 When indoor units are connected for cooling only in heat recovery system

- (a) Refer to the following table:

Status	Selectable	Not selectable
At any time	Auto or Custom auto, Cool, Dry, Fan	Heat

6-1-3 RB priority connection in heat recovery system

- (a) For indoor units or RB groups by RB priority connection, refer to the following table:

Status	Selectable	Not selectable
Cooling priority is set by external input.	Cool, Dry	Auto or Custom auto, Heat, Fan
Heating priority is set by external input.	Heat	Auto or Custom auto, Cool, Dry, Fan

6-1-4 Heat pump system

- (a) Refer to the following table:

Status	Selectable	Not selectable
Other indoor unit is in cooling operation.	Cool, Dry	Auto or Custom auto, Heat, Fan
Other indoor unit is in dehumidifying operation.	Cool, Dry	Auto or Custom auto, Heat, Fan
Other indoor unit is in heating operation.	Heat	Auto or Custom auto, Cool, Dry, Fan
Other indoor unit is in anti freeze operation.	Heat	Auto or Custom auto, Cool, Dry, Fan

- (b) When a master indoor unit is set in a refrigerant system, only the mode selected at the master indoor unit (*2) can be used. (*2: "Fan" cannot be selected at the indoor unit including the master indoor unit.)

6-1-5 Outdoor unit priority connection in heat pump system

- (a) Refer to the following table:

Status	Selectable	Not selectable
Cooling priority is set by external input.	Cool, Dry	Auto or Custom auto, Heat, Fan
Heating priority is set by external input.	Heat	Auto or Custom auto, Cool, Dry, Fan

6-2 Settable temperature range

The settable temperature range by operation mode and outdoor unit setting is shown in the table below.

Cool/Dry (*1)	18 to 30 °C (64 to 88 °F) or 20 to 30 °C (68 to 88 °F)
Heat	VRF system: 10 to 30 °C (48 to 88 °F) Other system: 16 to 30 °C (60 to 88 °F)
Custom auto	Same as the above range, but there are temperatures that cannot be set due to the deadband.
Auto (*1)	18 to 30 °C (64 to 88 °F) or 20 to 30 °C (68 to 88 °F)

- *1: The lower limit of the set temperature varies depending on the region of use.

7 Others

7-1 Outline Dimensions

Unit: mm (in)

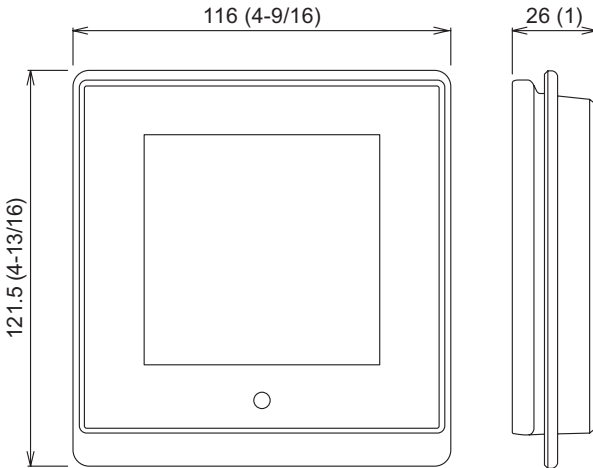

This product is manufactured to metric units and tolerances. United States customary units are provided for reference only. In cases where exact dimensions and tolerances are required, always refer to metric units.

7-2 Specifications

Model Name	UTY-RVR*
Input voltage	DC 12 V
Power consumption	Max. 1.0 W
Display	4 inch TFT LCD (480 × 480 pixels) with Touch screen
Usage temperature range	0 to 40 °C (32 to 104 °F)
Usage humidity range	20 to 90 % (no condensation)
Storage temperature range	-10 to 60 °C (14 to 140 °F)
Storage humidity range	20 to 90 % (no condensation)
Dimensions [H × W × D mm (in)]	121.5 × 116 × 26 (4-13/16 × 4-9/16 × 1)
Weight [g (oz)]	225 (7.94)

7-3 Error Code

For the details of the indoor unit or outdoor unit error when checking the error contents, refer to the error codes in each installation manual.

Error code	Contents
CC.1	Sensor error
CJ.1	Other parts (BLE module) error
C2.1	Transmission PCB error
12.1	Wired remote controller communication error
12.3	Number excess of device in wired remote controller system
12.4	Wired remote controller system start-up error
26.4	Address duplication in wired remote controller system
26.5	Address setting error in wired remote controller system
15.4	Data acquisition error

7-4 Information on Disposal of WEEE



This symbol on the product(s) and/or accompanying documents and/or packaging means that used electrical and electronic equipment (WEEE) integrates a battery/batteries must not be mixed with general household waste. For proper treatment, recovery and recycling of old products, please follow the rule in accordance with each national law of EU and other EEA countries.

Please do not try to remove the units by yourself and to do away into municipal waste stream.

For further information, please contact your local dealer or installer.

FUJITSU GENERAL LIMITED

3-3-17, Suenaga, Takatsu-ku, Kawasaki 213-8502, Japan