

# ENERGY RECOVERY VENTILATORS

## DESIGN & TECHNICAL MANUAL

---



UTZ-BD025C

UTZ-BD035C

UTZ-BD050C

UTZ-BD080C

UTZ-BD100C

# CONTENTS

---

## 1. SPECIFICATIONS

---

1-1. SPECIFICATIONS .....	01-01
---------------------------	-------

---

## 2. DIMENSIONS

---

2-1. UTZ-BD025C .....	01-03
2-2. UTZ-BD035C .....	01-05
2-3. UTZ-BD050C .....	01-07
2-4. UTZ-BD080C .....	01-09
2-5. UTZ-BD100C .....	01-11

---

## 3. WIRING DIAGRAMS

---

3-1. UTZ-BD025C .....	01-13
3-2. UTZ-BD035C, UTZ-BD050C .....	01-13
3-3. UTZ-BD080C, UTZ-BD100C .....	01-14
3-4. INTERLOCKED CONNECTION TO AIR CONDITIONER.....	01-15

---

## 4. DESIGN SECTION

---

<b>4-1. ABOUT HEAT EXCHANGE UNIT .....</b>	<b>01-17</b>
<b>4-1-1. BASIC ENGIN .....</b>	<b>01-17</b>
<b>4-1-2. INTERNAL STRUCTURE .....</b>	<b>01-18</b>
<b>4-1-3. HEAT EXCHANGE VENTILATION AND NORMAL VENTILATION.....</b>	<b>01-19</b>
<b>4-2. NEEDS FOR VENTILATION.....</b>	<b>01-20</b>
<b>4-2-1. OBJECTIVES AND EFFECTS OF VENTILATION .....</b>	<b>01-20</b>
<b>4-3. METHODS OF VENTILATION.....</b>	<b>01-21</b>
<b>4-4. DESIGN PRECAUTIONS .....</b>	<b>01-22</b>
<b>4-4-1. CAUTION ON SAFETY.....</b>	<b>01-22</b>
<b>4-4-2. INSPECTION OPENING AND INSTALLATION MODELS .....</b>	<b>01-23</b>
<b>4-4-3. USE ENVIRONMENTS .....</b>	<b>01-24</b>
<b>4-4-4. HEAT EXCHANGE EFFICIENCY .....</b>	<b>01-25</b>
<b>4-4-5. DUST COLLECTION EFFICIENCY .....</b>	<b>01-27</b>
<b>4-4-6. NOISE .....</b>	<b>01-28</b>
<b>4-4-7. NOISE CONTROL.....</b>	<b>01-29</b>
<b>4-5. VENTILATION DESIGN .....</b>	<b>01-31</b>
<b>4-5-1. QUANTITY, DYNAMIC PRESSURE / STATIC PRESSURE .....</b>	<b>01-31</b>
<b>4-5-2. HOW TO CALCULATE REQUIRED VENTILATION VOLUME.....</b>	<b>01-32</b>
<b>4-6. DUCT DESIGN.....</b>	<b>01-33</b>
<b>4-6-1. CALCULATION OF PRESSURE LOSSES DUE TO VENTILATION         THROUGH DUCT .....</b>	<b>01-33</b>

---

## **5. REMOTE CONTROLLER**

---

<b>5-1. FUNCTIONS .....</b>	<b>01-36</b>
<b>5-2. SYSTEM DIAGRAM .....</b>	<b>01-36</b>
<b>5-3. ELECTRICAL WIRING .....</b>	<b>01-37</b>
<b>5-4. DIMENSIONS .....</b>	<b>01-37</b>
<b>5-5. SPECIFICATIONS .....</b>	<b>01-37</b>
<b>5-6. WIRING SPECIFICATIONS .....</b>	<b>01-37</b>

# 1. SPECIFICATIONS

## 1-1. SPECIFICATIONS

Model No.		UTZ-BD025C					
Item							
Power Source		220-240V~ 50Hz					
Ventilation Mode		Heat Exchange Ventilation			Normal Ventilation		
Notch		(Extra high)	High	Low	(Extra high)	High	Low
Input (W)		112-128	108-123	87-96	112-128	108-123	87-96
Air Volume (m <sup>3</sup> /h)		250	250	190	250	250	190
External Static Pressure (Pa)		105	95	45	105	95	45
Sound Pressure Level (dB)		30.0-31.5	29.5-30.5	23.5-26.5	30.0-31.5	29.5-30.5	23.5-26.5
Temperature Exchange Efficiency (%)		75	75	77	—	—	—
Dimensions (mm) (H x W x D)	Net	270 x 882 x 599					
	Gross	349 x 1132 x 795					
Weight (kg)	Net	29					
	Gross	35					
Outlet Duct Diameter (mm)		150					
Operation Range (°C)		-10 to 40					
Maximum Humidity (%)		85					

Model No.		UTZ-BD035C					
Item							
Power Source		220-240V~ 50Hz					
Ventilation Mode		Heat Exchange Ventilation			Normal Ventilation		
Notch		(Extra high)	High	Low	(Extra high)	High	Low
Input (W)		182-190	178-185	175-168	182-190	178-185	175-168
Air Volume (m <sup>3</sup> /h)		350	350	240	350	350	240
External Static Pressure (Pa)		140	60	45	140	60	45
Sound Pressure Level (dB)		32.5-33.0	30.5-31.0	22.5-25.5	32.5-33.0	30.5-31.0	22.5-25.5
Temperature Exchange Efficiency (%)		75	75	78	—	—	—
Dimensions (mm) (H x W x D)	Net	317 x 1050 x 804					
	Gross	396 x 1250 x 1000					
Weight (kg)	Net	49					
	Gross	57					
Outlet Duct Diameter (mm)		150					
Operation Range (°C)		-10 to 40					
Maximum Humidity (%)		85					

Model No.		UTZ-BD050C					
Item							
Power Source		220-240V~ 50Hz					
Ventilation Mode		Heat Exchange Ventilation			Normal Ventilation		
Notch		(Extra high)	High	Low	(Extra high)	High	Low
Input (W)		263-289	204-225	165-185	263-289	204-225	165-185
Air Volume (m <sup>3</sup> /h)		500	500	440	500	500	440
External Static Pressure (Pa)		120	60	35	120	60	35
Sound Pressure Level (dB)		36.5-37.5	34.5-35.5	31.0-32.5	37.5-38.5	37.0-38.0	31.0-32.5
Temperature Exchange Efficiency (%)		75	75	76	—	—	—
Dimensions (mm) (H x W x D)	Net	317 x 1090 x 904					
	Gross	396 x 1290 x 1100					
Weight (kg)	Net	57					
	Gross	66					
Outlet Duct Diameter (mm)		200					
Operation Range (°C)		-10 to 40					
Maximum Humidity (%)		85					

Item	Model No.	UTZ-BD080C					
Power Source		220-240V~ 50Hz					
Ventilation Mode		Heat Exchange Ventilation			Normal Ventilation		
Notch		(Extra high)	High	Low	(Extra high)	High	Low
Input (W)		387-418	360-378	293-295	387-418	360-378	293-295
Air Volume (m <sup>3</sup> /h)		800	800	630	800	800	630
External Static Pressure (Pa)		140	110	55	140	110	55
Sound Pressure Level (dB)		37.0-37.5	36.5-37.0	33.5-34.5	37.0-37.5	36.5-37.0	33.5-34.5
Temperature Exchange Efficiency (%)		75	75	76	—	—	—
Dimensions (mm) (H x W x D)	Net	388 x 1322 x 884					
	Gross	467 x 1552 x 1080					
Weight (kg)	Net	71					
	Gross	82					
Outlet Duct Diameter (mm)		250					
Operation Range (°C)		-10 to 40					
Maximum Humidity (%)		85					

Item	Model No.	UTZ-BD100C					
Power Source		220-240V~ 50Hz					
Ventilation Mode		Heat Exchange Ventilation			Normal Ventilation		
Notch		(Extra high)	High	Low	(Extra high)	High	Low
Input (W)		437-464	416-432	301-311	437-464	416-432	301-311
Air Volume (m <sup>3</sup> /h)		1000	1000	700	1000	1000	700
External Static Pressure (Pa)		105	80	75	105	80	75
Sound Pressure Level (dB)		37.5-38.5	37.0-37.5	33.5-34.5	39.5-40.5	39.0-39.5	35.5-36.5
Temperature Exchange Efficiency (%)		75	75	79	—	—	—
Dimensions (mm) (H x W x D)	Net	388 x 1322 x 1134					
	Gross	467 x 1552 x 1330					
Weight (kg)	Net	83					
	Gross	98					
Outlet Duct Diameter (mm)		250					
Operation Range (°C)		-10 to 40					
Maximum Humidity (%)		85					

(Note) This noise of the product is the value which was measured at the acoustic room. Actually, in the established condition, that undergo influence by the echoing of the room and so that become bigger than the display numerical value.

# 2. DIMENTIONS

## 2-1. UTZ-BD025C

Unit: mm

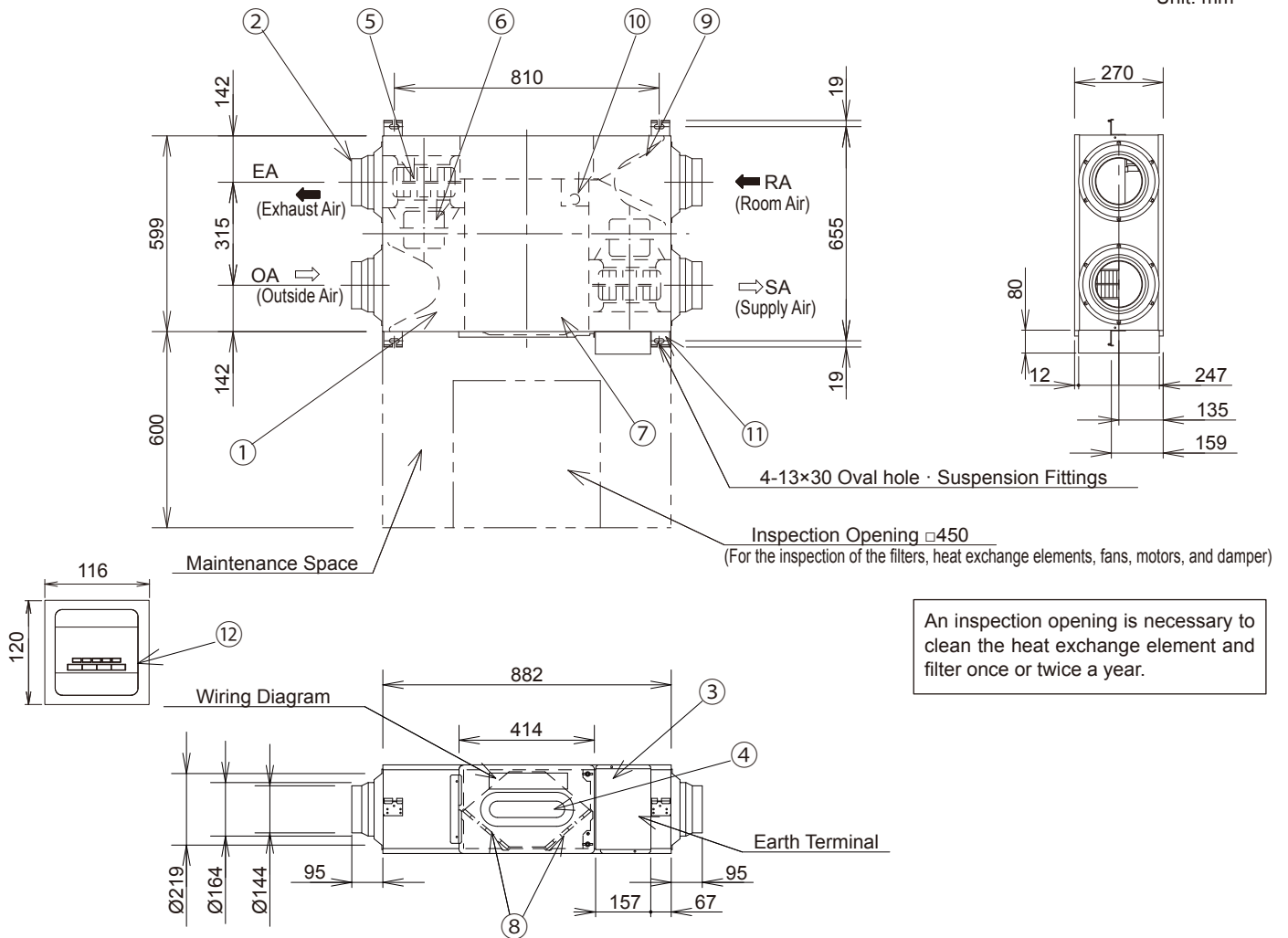

An inspection opening is necessary to clean the heat exchange element and filter once or twice a year.

NO.	Parts Name	Qty.	Material	Remarks
1	Frame	1	Galvanized sheets	
2	Adapter	4	ABS	
3	Electrical Equipment Box	1		
4	Inspection Cover	1	Galvanized sheets	
5	Fan	2	ABS	
6	Motor	2		
7	Heat Exchange Element	1	Special paper + Resin	
8	Filter	2	Nylon-Polyester Fiber	Collection Efficiency AFI 82%
9	Damper	1		
10	Damper Motor	1		
11	Ceiling Suspension Fixture	4	Galvanized sheets	
12	Energy Recovery Ventilator Remocon	1		

### BE CAREFUL OF DEWING AND FROSTING

As shown in the Figure, suppose a high temp absorbing air condition A and a low temp absorbing air condition B are plotted on the air line figure, then a high temp air A is heat-exchanged by the unit and goes out of the saturation curve as shown by Point C. In this case, the unit will be dewed or frosted. To avoid this, you are required to heat a low temp air B up to B' so as to get C' below the saturation curve, before using the unit.

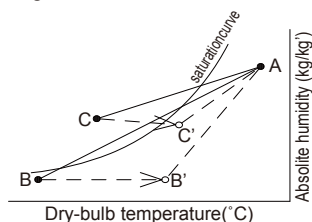

### REFERENCE SKETCH

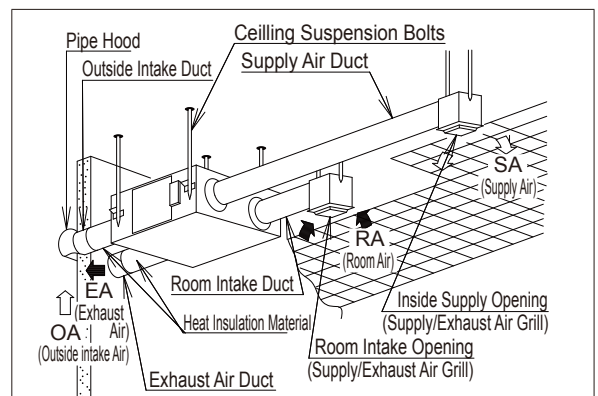

The two outside ducts (the Outside Intake Duct and the Exhaust Duct) must be insulated to prevent condensation. (Material; Glass wool, Thickness; 25)

- \* Duct size (Nominal Diameter):  $\phi 150$
- \*\* The above dimensions do not include the thickness of the insulation material on the unit body.

## ■ SPECIFICATIONS

Model No.	Power Source	Notch	Frequency (Hz)	Heat Exchange Ventilation								Normal Ventilation					Product Weight (kg)
				Input (W)	Current (A)	Air Volume (m <sup>3</sup> /h)	External Static Pressure (Pa)	Temperature Exchange Efficiency (%)	Enthalpy Exchange Efficiency (%)		Noise (dB)	Input (W)	Current (A)	Air Volume (m <sup>3</sup> /h)	External Static Pressure (Pa)	Noise (dB)	
									Cooling	Heating							
UTZ-BD025C	220-240V a.c.	Extra High	50	112-128	0.51-0.53	250	105	75	63	70	30.0-31.5	112-128	0.51-0.53	250	105	30.0-31.5	29
		High	50	108-123	0.49-0.51	250	95	75	63	70	29.5-30.5	108-123	0.49-0.51	250	95	29.5-30.5	
		Low	50	87-96	0.40-0.41	190	45	77	65	72	23.5-26.5	87-96	0.40-0.41	190	45	23.5-26.5	

\* This noise of the product is the value which was measured at the acoustic room. Actually, in the established condition, that undergo influence by the echoing of the room and so that become bigger than the display numerical value .

## ■ PERFORMANCE

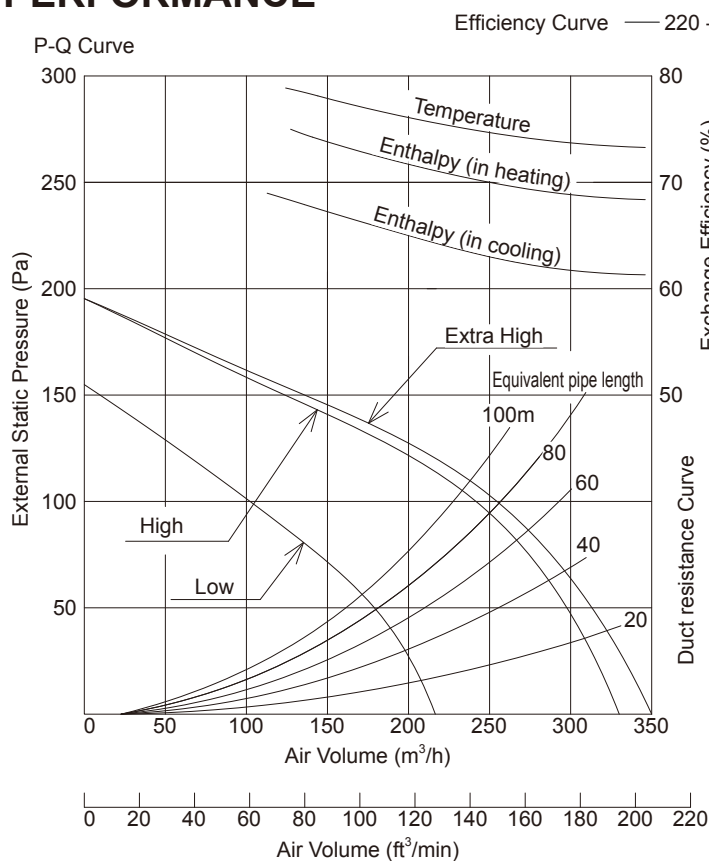

\* When friction coefficient of pipe (duct) :  $\lambda=0.02$

Use conditions	
Outdoor air conditions Temperature range -10°C ~ 40°C Relative humidity 85% or less	
Indoor air conditions Temperature range -10°C ~ 40°C Relative humidity 85% or less	
Installation requirements Same as the indoor air conditions	
* Indoor air here means air in air-conditioned living rooms. Its use in refrigerators or other places where temperature can fluctuate greatly is prohibited even if a temperature range is acceptable.	
Example	Indoor air conditions
During cooling period Temperature 27°C Relative humidity 50%	
During heating period Temperature 20°C Relative humidity 40%	

## ■ MOTOR SPECIFICATIONS

Type	4 Poles open type induction motor
Rating	Cont.
Insulation Class	class B
Temperature Rise	under 80 K
Sorrounding Temperature	-10°C ~ 40°C
Insulation Resistance	over 1MΩ (by DC500V)
Withstand Voltage	AC 1,500V for 1min
Input (Reference)	56-64 W (220-240V)
Output (Reference)	20 W (220V)
Diameter	Ø82 mm
Weight	2.1 kg
Lot 11	Not Applicable (Below 125W)

- The Input, the current and the exchange efficiency are values at the time of the mentioned air volume.
- The noise level shall be measured 1.5m below the center of the unit.
- The temperature exchange efficiency averages that of when cooling and when heating.



## 2-2. UTZ-BD035C

Unit: mm

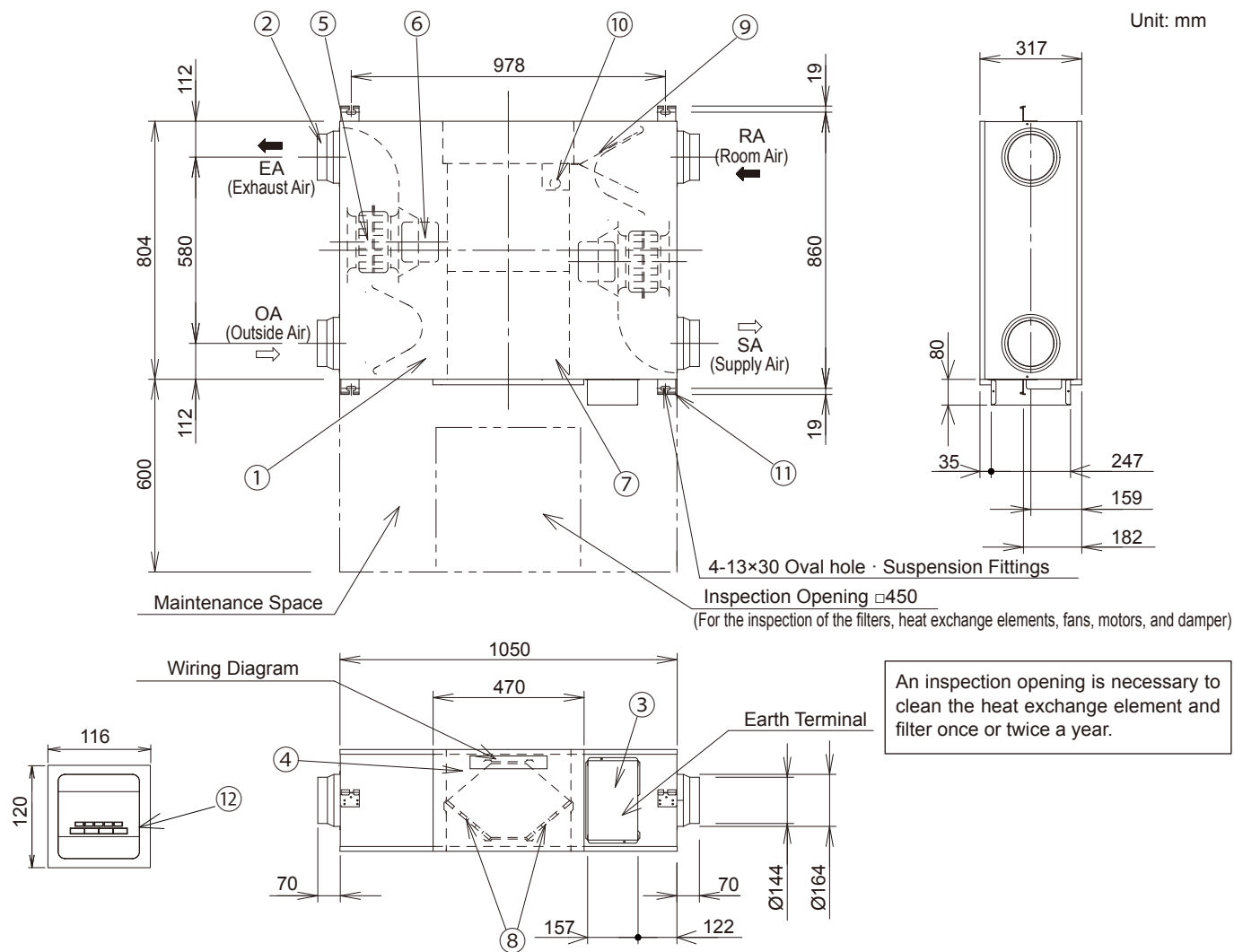

NO.	Parts Name	Qty.	Material	Remarks
1	Frame	1	Galvanized sheets	
2	Adapter	4	ABS	
3	Electrical Equipment Box	1		
4	Inspection Cover	1	Galvanized sheets	
5	Fan	2	ABS	
6	Motor	2		
7	Heat Exchange Element	2	Special paper + Resin	
8	Filter	2	Nylon-Polyester Fiber	Collection Efficiency AFI 82%
9	Damper	1		
10	Damper Motor	1		
11	Ceiling Suspension Fixture	4	Galvanized sheets	
12	Energy Recovery Ventilator Remocon	1		

### BE CAREFUL OF DEWING AND FROSTING

As shown in the Figure, suppose a high temp absorbing air condition A and a low temp absorbing air condition B are plotted on the air line figure, then a high temp air A is heat-exchanged by the unit and goes out of the saturation curve as shown by Point C.

In this case, the unit will be dewed or frosted.

To avoid this, you are required to heat a low temp air B up to B' so as to get C' below the saturation curve, before using the unit.

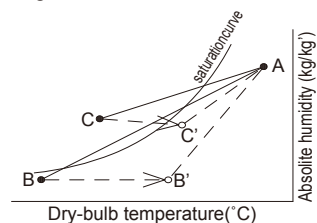

### REFERENCE SKETCH

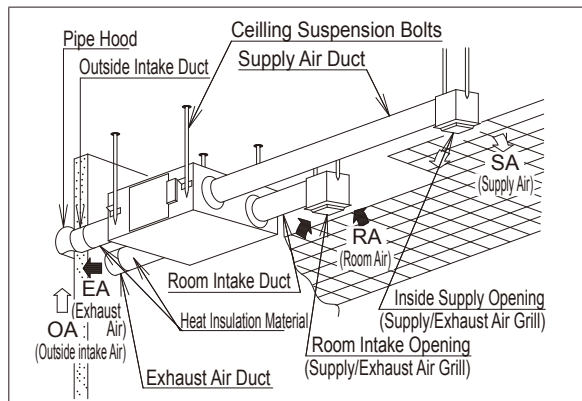

The two outside ducts (the Outside Intake Duct and the Exhaust Duct) must be insulated to prevent condensation. (Material: Glass wool, Thickness: 25)

- \* Duct size (Nominal Diameter):  $\phi 150$
- \*\* The above dimensions do not include the thickness of the insulation material on the unit body.

## ■ SPECIFICATIONS

Model No.	Power Source	Notch	Frequency (Hz)	Heat Exchange Ventilation								Normal Ventilation					Product Weight (kg)
				Input (W)	Current (A)	Air Volume (m <sup>3</sup> /h)	External Static Pressure (Pa)	Temperature Exchange Efficiency (%)	Enthalpy Exchange Efficiency (%)		Noise (dB)	Input (W)	Current (A)	Air Volume (m <sup>3</sup> /h)	External Static Pressure (Pa)	Noise (dB)	
									Cooling	Heating							
UTZ-BD035C	220-240V a.c.	Extra High	50	182-190	0.83-0.79	350	140	75	66	69	32.5-33.0	182-190	0.83-0.79	350	140	32.5-33.0	49
		High	50	178-185	0.81-0.77	350	60	75	66	69	30.5-31.0	178-185	0.81-0.77	350	60	30.5-31.0	
		Low	50	175-168	0.79-0.70	240	45	78	71	73	22.5-25.5	175-168	0.79-0.70	240	45	22.5-25.5	

\* This noise of the product is the value which was measured at the acoustic room. Actually, in the established condition, that undergo influence by the echoing of the room and so that become bigger than the display numerical value .

## ■ PERFORMANCE

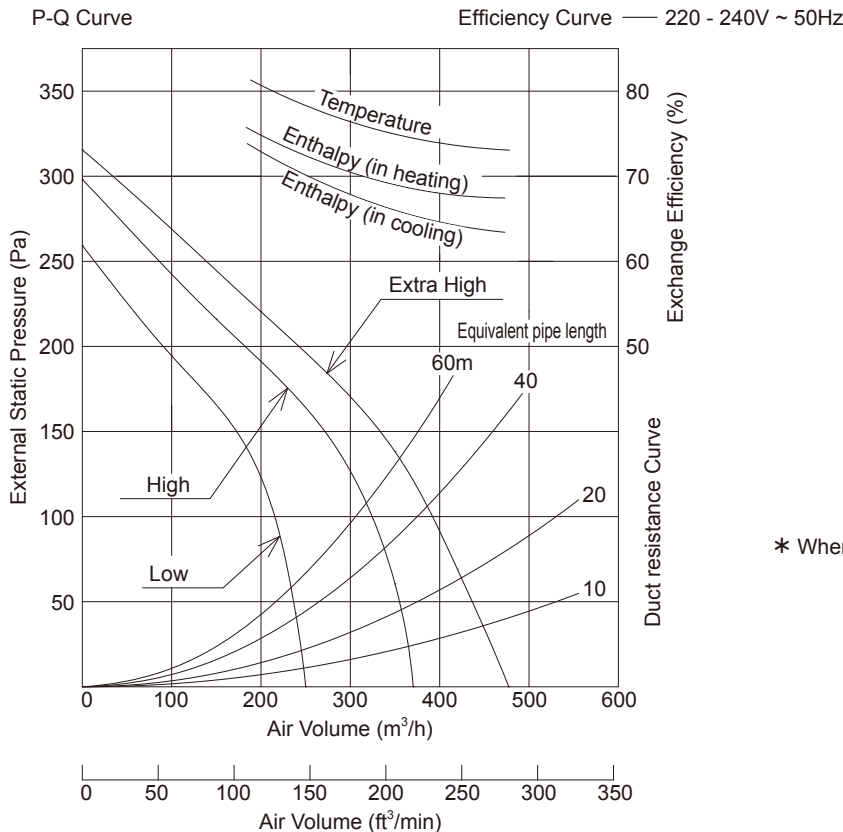

\* When friction coefficient of pipe (duct) :  $\lambda=0.02$

Use conditions	
Outdoor air conditions	Temperature range -10°C ~ 40°C Relative humidity 85% or less
Indoor air conditions	Temperature range -10°C ~ 40°C Relative humidity 85% or less
Installation requirements	Same as the indoor air conditions
* Indoor air here means air in air-conditioned living rooms.	
Its use in refrigerators or other places where temperature can fluctuate greatly is prohibited even if a temperature range is acceptable.	
<b>Example</b>	Indoor air conditions
During cooling period	
Temperature 27°C	
Relative humidity 50%	
During heating period	
Temperature 20°C	
Relative humidity 40%	

## ■ MOTOR SPECIFICATIONS

Type	4 Poles open type induction motor
Rating	Cont.
Insulation Class	class F
Temperature Rise	under 100 K
Sorrounding Temperature	-10°C ~ 40°C
Insulation Resistance	over 1MΩ (by DC500V)
Withstand Voltage	AC 1,500V for 1min
Input (Reference)	91-95 W (220-240V)
Output (Reference)	40 W (220V)
Diameter	Ø97 mm
Weight	2.5 kg
Lot 11	Not Applicable (Below 125W)

- The Input, the current and the exchange efficiency are values at the time of the mentioned air volume.
- The noise level shall be measured 1.5m below the center of the unit.
- The temperature exchange efficiency averages that of when cooling and when heating.

# 2-3. UTZ-BD050C

Unit: mm

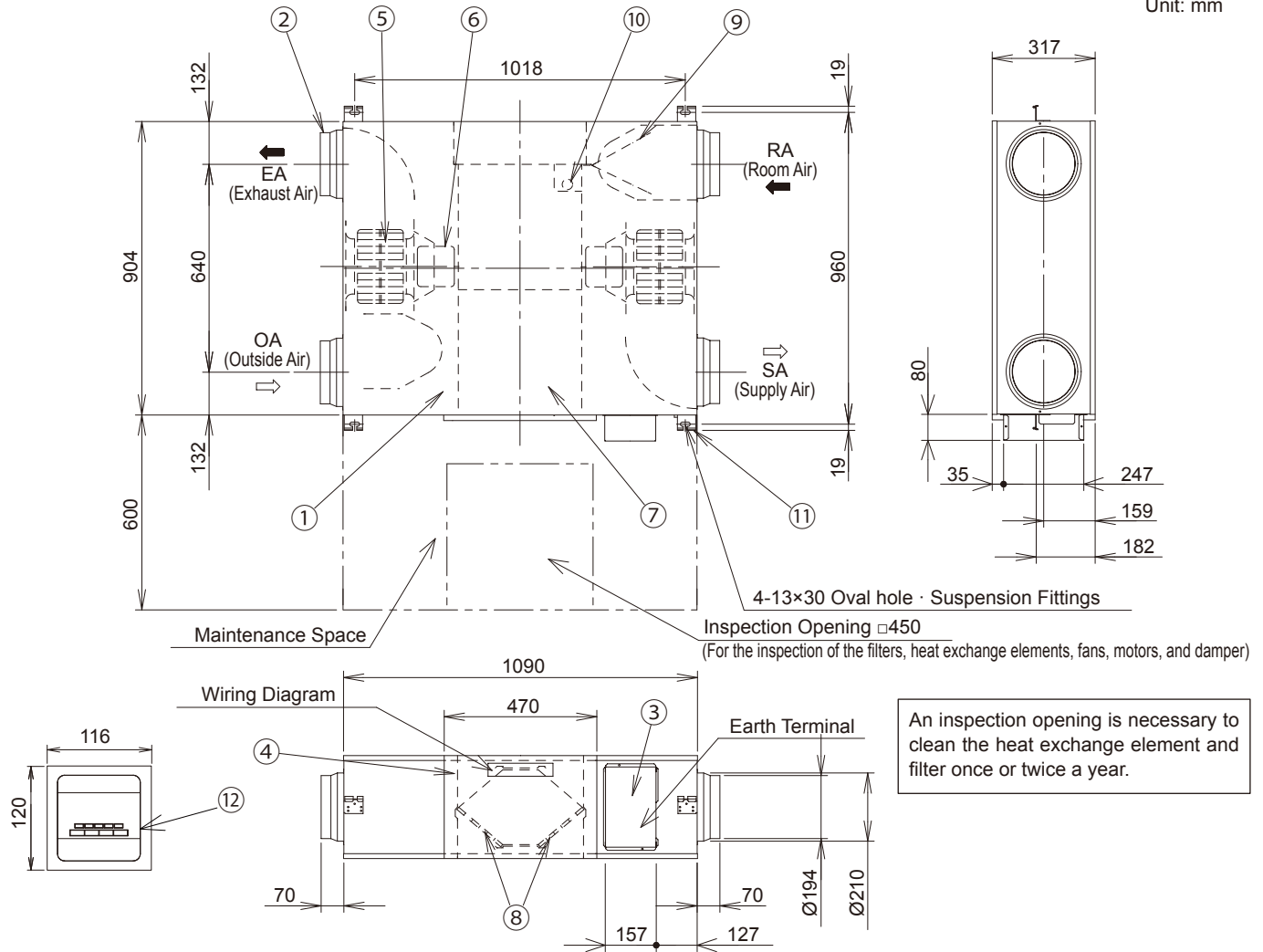

NO.	Parts Name	Qty.	Material	Remarks
1	Frame	1	Galvanized sheets	
2	Adapter	4	ABS	
3	Electrical Equipment Box	1		
4	Inspection Cover	1	Galvanized sheets	
5	Fan	2	ABS	
6	Motor	2		
7	Heat Exchange Element	2	Special paper + Resin	
8	Filter	2	Nylon-Polyester Fiber	Collection Efficiency AFI 82%
9	Damper	1		
10	Damper Motor	1		
11	Ceiling Suspension Fixture	4	Galvanized sheets	
12	Energy Recovery Ventilator Remocon	1		

## BE CAREFUL OF DEWING AND FROSTING

As shown in the Figure, suppose a high temp absorbing air condition A and a low temp absorbing air condition B are plotted on the air line figure, then a high temp air A is heat-exchanged by the unit and goes out of the saturation curve as shown by Point C. In this case, the unit will be dewed or frosted. To avoid this, you are required to heat a low temp air B up to B' so as to get C' below the saturation curve, before using the unit.

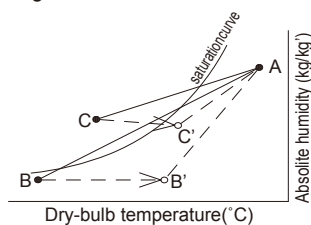

## REFERENCE SKETCH

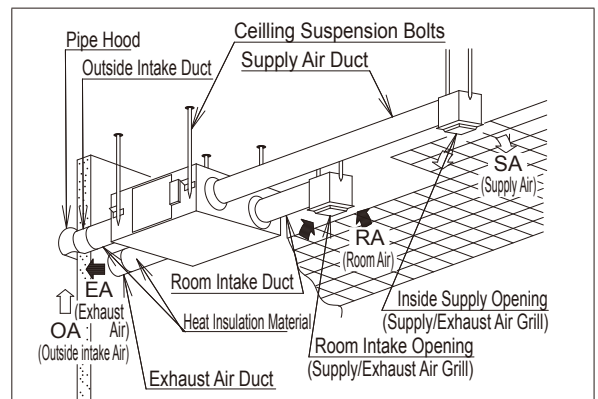

The two outside ducts (the Outside Intake Duct and the Exhaust Duct) must be insulated to prevent condensation. (Material: Glass wool, Thickness: 25)

- \* Duct size (Nominal Diameter):  $\varnothing 200$
- \*\* The above dimensions do not include the thickness of the insulation material on the unit body.

## ■ SPECIFICATIONS

Model No.	Power Source	Notch	Frequency (Hz)	Heat Exchange Ventilation							Normal Ventilation					Product Weight (kg)	
				Input (W)	Current (A)	Air Volume (m <sup>3</sup> /h)	External Static Pressure (Pa)	Temperature Exchange Efficiency (%)	Enthalpy Exchange Efficiency (%)		Noise (dB)	Input (W)	Current (A)	Air Volume (m <sup>3</sup> /h)	External Static Pressure (Pa)		Noise (dB)
									Cooling	Heating							
UTZ-BD050C	220-240V a.c.	Extra High	50	263-289	1.20-1.21	500	120	75	62	67	36.5-37.5	263-289	1.20-1.21	500	120	37.5-38.5	57
		High	50	204-225	0.93-0.94	500	60	75	62	67	34.5-35.5	204-225	0.93-0.94	500	60	37.0-38.0	
		Low	50	165-185	0.75-0.77	440	35	76	64	69	31.0-32.5	165-185	0.75-0.77	440	35	31.0-32.5	

\* This noise of the product is the value which was measured at the acoustic room. Actually, in the established condition, that undergo influence by the echoing of the room and so that become bigger than the display numerical value .

## ■ PERFORMANCE

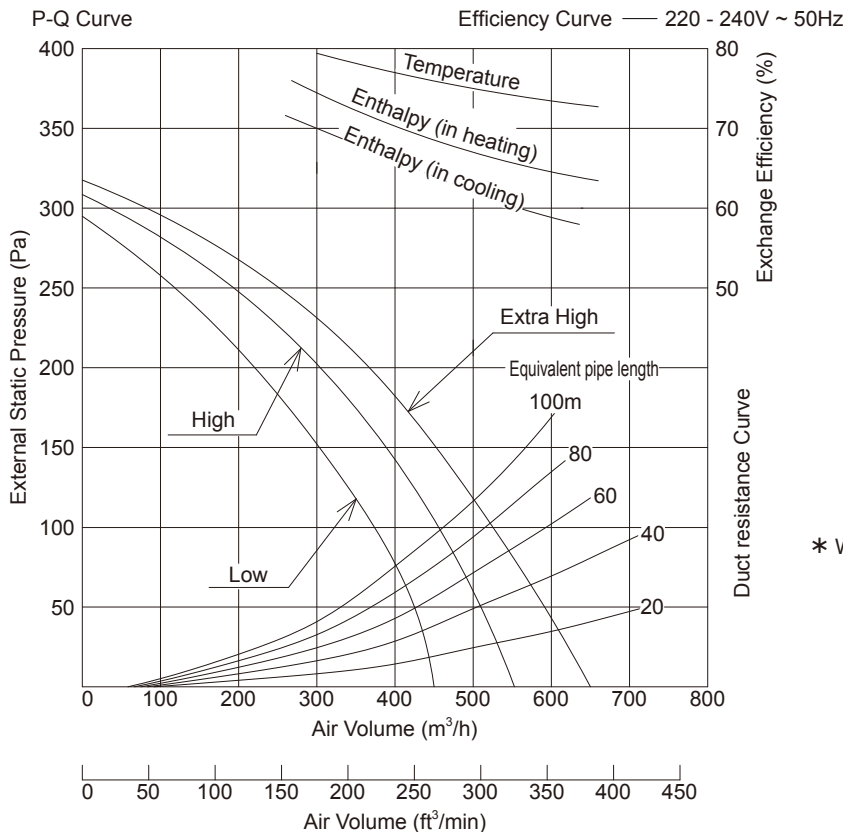

\* When friction coefficient of pipe (duct) :  $\lambda=0.02$

Use conditions	
Outdoor air conditions Temperature range -10°C ~ 40°C Relative humidity 85% or less	
Indoor air conditions Temperature range -10°C ~ 40°C Relative humidity 85% or less	
Installation requirements Same as the indoor air conditions	
* Indoor air here means air in air-conditioned living rooms. Its use in refrigerators or other places where temperature can fluctuate greatly is prohibited even if a temperature range is acceptable.	
Example	Indoor air conditions
During cooling period Temperature 27°C Relative humidity 50%	
During heating period Temperature 20°C Relative humidity 40%	

## ■ MOTOR SPECIFICATIONS

Type	4 Poles open type induction motor
Rating	Cont.
Insulation Class	class B
Temperature Rise	under 80 K
Sorrounding Temperature	-10°C ~ 40°C
Insulation Resistance	over 1MΩ (by DC500V)
Withstand Voltage	AC 1,500V for 1min
Input (Reference)	131-145 W (220-240V)
Output (Reference)	70 W (220V)
Diameter	Ø123 mm
Weight	2.7 kg
Lot 11	Not Applicable (Below 125W)

- The Input, the current and the exchange efficiency are values at the time of the mentioned air volume.
- The noise level shall be measured 1.5m below the center of the unit.
- The temperature exchange efficiency averages that of when cooling and when heating.

## 2-4. UTZ-BD080C

Unit: mm

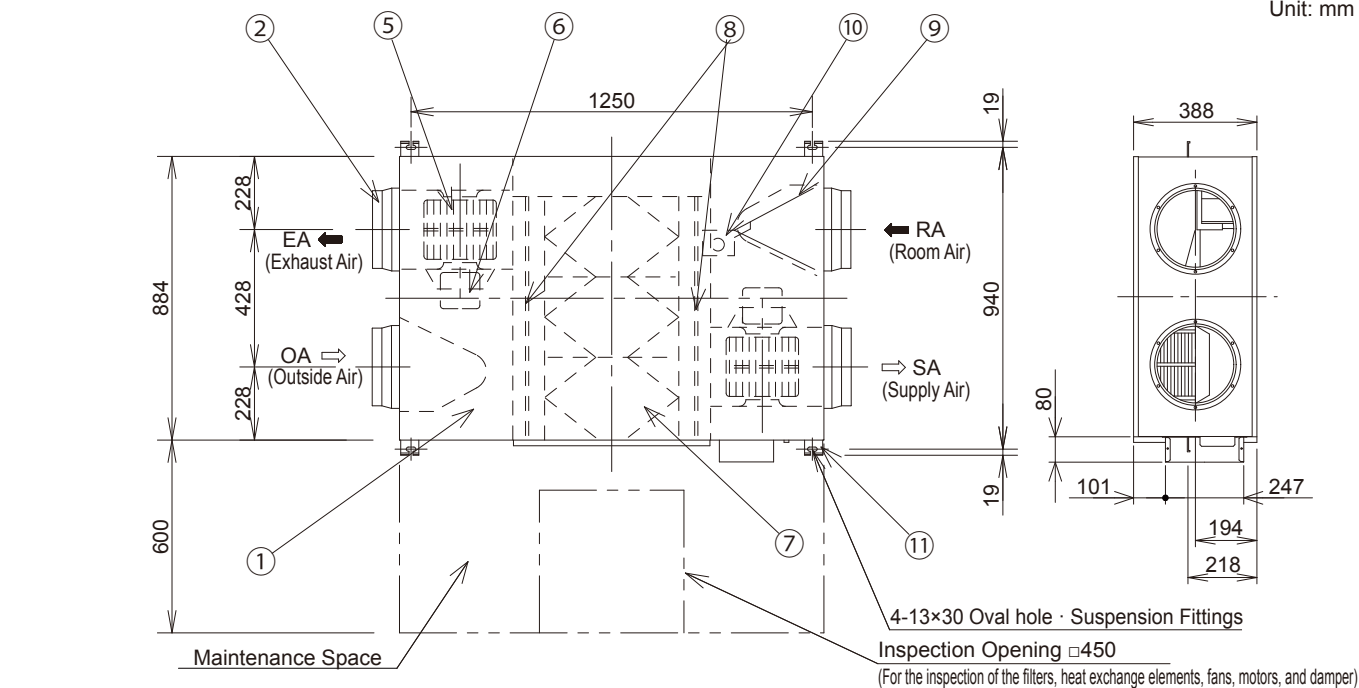

An inspection opening is necessary to clean the heat exchange element and filter once or twice a year.

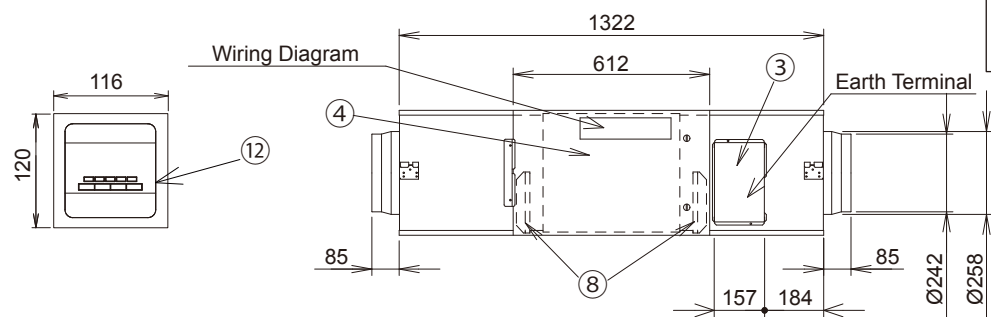

NO.	Parts Name	Qty.	Material	Remarks
1	Frame	1	Galvanized sheets	
2	Adapter	4	ABS	
3	Electrical Equipment Box	1		
4	Inspection Cover	1	Galvanized sheets	
5	Fan	2	ABS	
6	Motor	2		
7	Heat Exchange Element	3	Special paper + Resin	
8	Filter	2	Nylon-Polyester Fiber	Collection Efficiency AFI 82%
9	Damper	1		
10	Damper Motor	1		
11	Ceiling Suspension Fixture	4	Galvanized sheets	
12	Energy Recovery Ventilator Remocon	1		

### BE CAREFUL OF DEWING AND FROSTING

As shown in the Figure, suppose a high temp absorbing air condition A and a low temp absorbing air condition B are plotted on the air line figure, then a high temp air A is heat-exchanged by the unit and goes out of the saturation curve as shown by Point C. In this case, the unit will be dewed or frosted. To avoid this, you are required to heat a low temp air B up to B' so as to get C' below the saturation curve, before using the unit.

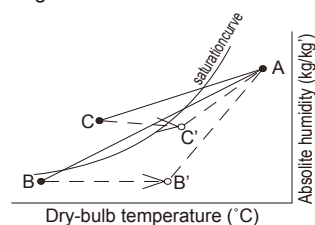

### REFERENCE SKETCH

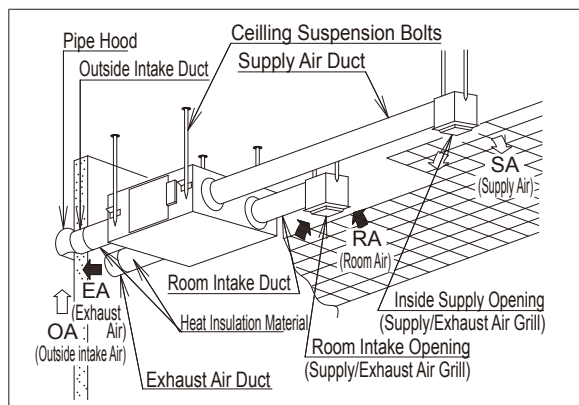

The two outside ducts (the Outside Intake Duct and the Exhaust Duct) must be insulated to prevent condensation. (Material; Glass wool, Thickness; 25)

- \* Duct size (Nominal Diameter):  $\varnothing 250$
- \*\* The above dimensions do not include the thickness of the insulation material on the unit body.

## ■ SPECIFICATIONS

Model No.	Power Source	Notch	Frequency (Hz)	Heat Exchange Ventilation							Normal Ventilation					Product Weight (kg)	
				Input (W)	Current (A)	Air Volume (m³/h)	External Static Pressure (Pa)	Temperature Exchange Efficiency (%)	Enthalpy Exchange Efficiency (%)		Noise (dB)	Input (W)	Current (A)	Air Volume (m³/h)	External Static Pressure (Pa)		Noise (dB)
									Cooling	Heating							
UTZ-BD080C	220-240V a.c.	Extra High	50	387-418	1.76-1.74	800	140	75	65	71	37.0-37.5	387-418	1.76-1.74	800	140	37.0-37.5	71
		High	50	360-378	1.64-1.58	800	110	75	65	71	36.5-37.0	360-378	1.64-1.58	800	110	36.5-37.0	
		Low	50	293-295	1.33-1.23	630	55	76	68	74	33.5-34.5	293-295	1.33-1.23	630	55	33.5-34.5	

\* This noise of the product is the value which was measured at the acoustic room. Actually, in the established condition, that undergo influence by the echoing of the room and so that become bigger than the display numerical value.

## ■ PERFORMANCE

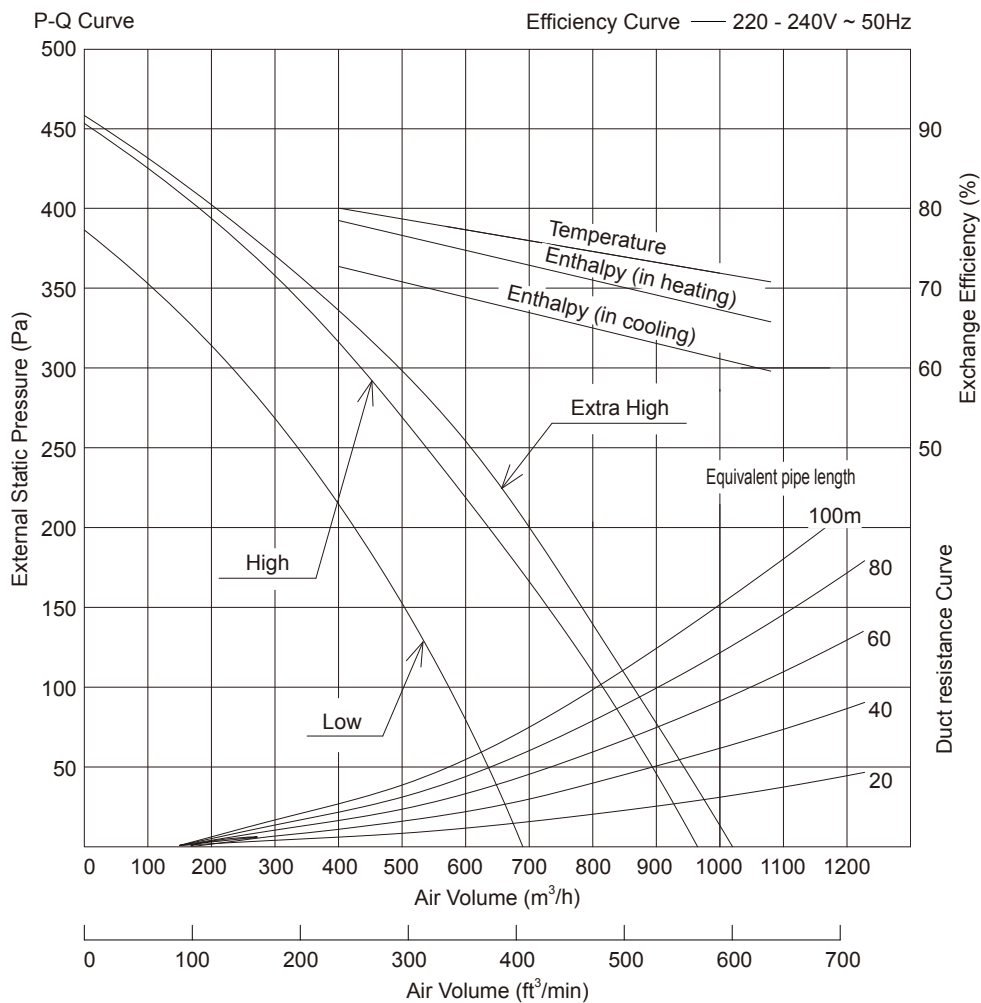

\* When friction coefficient of pipe (duct) :  $\lambda=0.02$

Use conditions	
Outdoor air conditions Temperature range -10°C ~ 40°C Relative humidity 85% or less	
Indoor air conditions Temperature range -10°C ~ 40°C Relative humidity 85% or less	
Installation requirements Same as the indoor air conditions	
* Indoor air here means air in air-conditioned living rooms. Its use in refrigerators or other places where temperature can fluctuate greatly is prohibited even if a temperature range is acceptable.	
<b>Example</b>	Indoor air conditions
During cooling period Temperature 27°C Relative humidity 50%	
During heating period Temperature 20°C Relative humidity 40%	

## ■ MOTOR SPECIFICATIONS

Type	4 Poles open type induction motor
Rating	Cont.
Insulation Class	class B
Temperature Rise	under 80 K
Surrounding Temperature	-10°C ~ 40°C
Insulation Resistance	over 1MΩ (by DC500V)
Withstand Voltage	AC 1,500V for 1min
Input (Reference)	193-209 W (220-240V)
Output (Reference)	180 W (220V)
Diameter	Ø123 mm
Weight	3.5 kg
Lot 11	Applicable (Over 125W)

- The Input, the current and the exchange efficiency are values at the time of the mentioned air volume.
- The noise level shall be measured 1.5m below the center of the unit.
- The temperature exchange efficiency averages that of when cooling and when heating.

# 2-5. UTZ-BD100C

Unit: mm

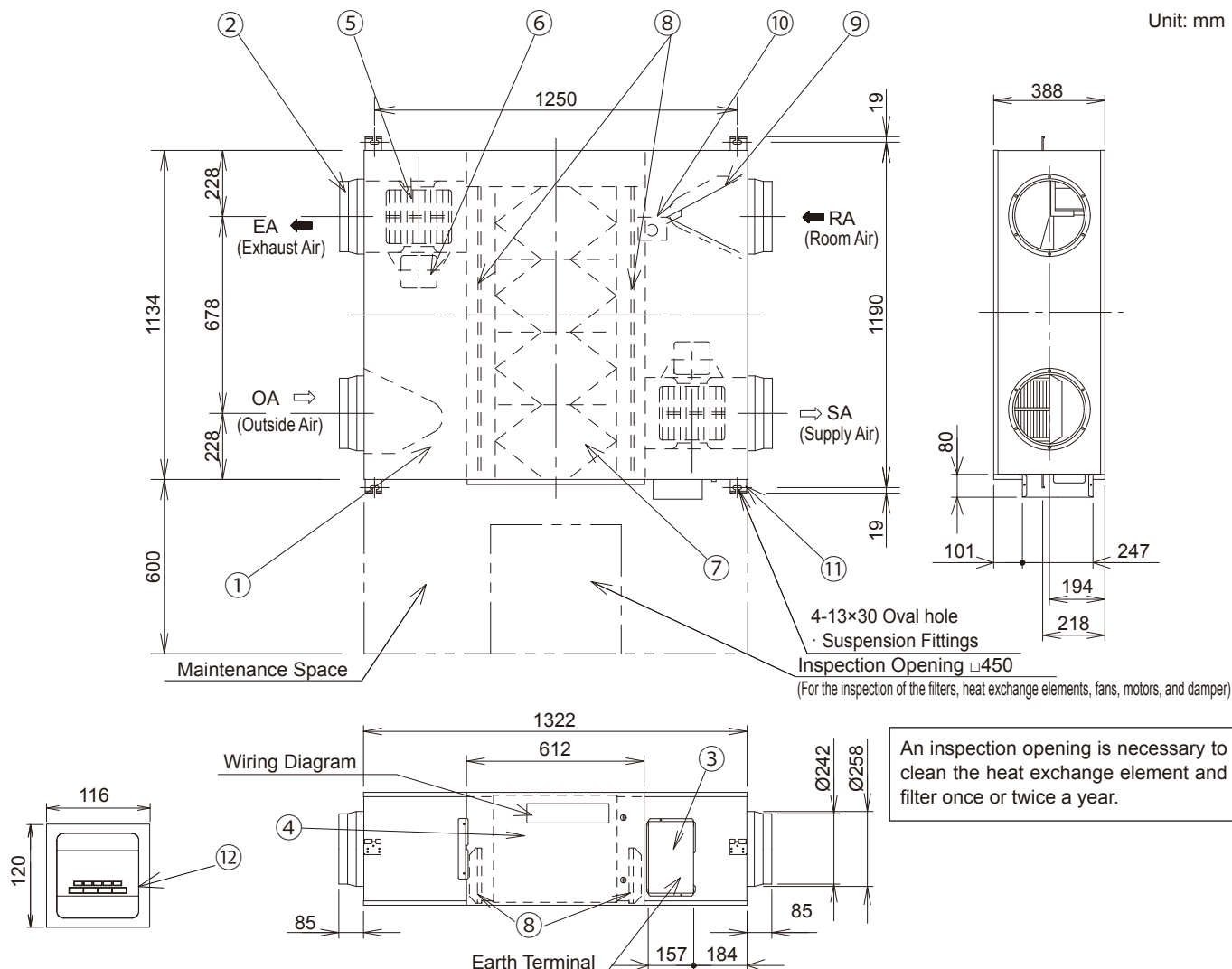

NO.	Parts Name	Qty.	Material	Remarks
1	Frame	1	Galvanized sheets	
2	Adapter	4	ABS	
3	Electrical Equipment Box	1		
4	Inspection Cover	1	Galvanized sheets	
5	Fan	2	ABS	
6	Motor	2		
7	Heat Exchange Element	4	Special paper + Resin	
8	Filter	2	Nylon-Polyester Fiber	Collection Efficiency AFI 82%
9	Damper	1		
10	Damper Motor	1		
11	Ceiling Suspension Fixture	4	Galvanized sheets	
12	Energy Recovery Ventilator Remocon	1		

## BE CAREFUL OF DEWING AND FROSTING

As shown in the Figure, suppose a high temp absorbing air condition A and a low temp absorbing air condition B are plotted on the air line figure, then a high temp air A is heat-exchanged by the unit and goes out of the saturation curve as shown by Point C. In this case, the unit will be dewed or frosted. To avoid this, you are required to heat a low temp air B up to B' so as to get C' below the saturation curve, before using the unit.

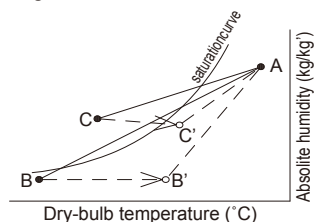

## REFERENCE SKETCH

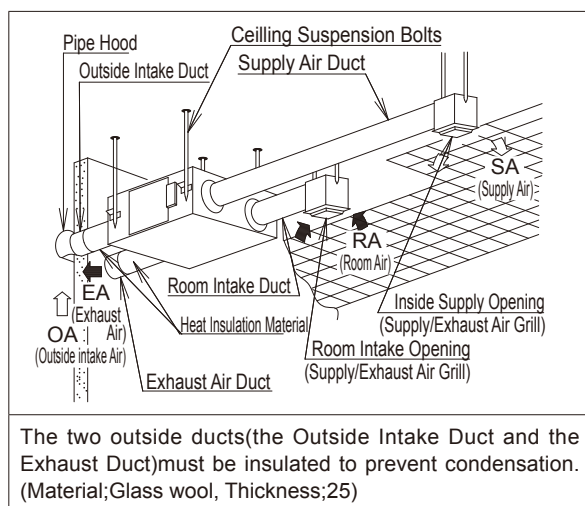

The two outside ducts (the Outside Intake Duct and the Exhaust Duct) must be insulated to prevent condensation. (Material: Glass wool, Thickness: 25)

- \* Duct size (Nominal Diameter):  $\phi 250$
- \*\* The above dimensions do not include the thickness of the insulation material on the unit body.

## ■ SPECIFICATIONS

Model No.	Power Source	Notch	Frequency (Hz)	Heat Exchange Ventilation							Normal Ventilation					Product Weight (kg)	
				Input (W)	Current (A)	Air Volume (m <sup>3</sup> /h)	External Static Pressure (Pa)	Temperature Exchange Efficiency (%)	Enthalpy Exchange Efficiency (%)		Noise (dB)	Input (W)	Current (A)	Air Volume (m <sup>3</sup> /h)	External Static Pressure (Pa)		Noise (dB)
									Cooling	Heating							
UTZ-BD100C	220-240V a.c.	Extra High	50	437-464	1.99-1.93	1000	105	75	65	71	37.5-38.5	437-464	1.99-1.93	1000	105	39.5-40.5	83
		High	50	416-432	1.89-1.80	1000	80	75	65	71	37.0-37.5	416-432	1.89-1.80	1000	80	39.0-39.5	
		Low	50	301-311	1.37-1.29	700	75	79	70	76	33.5-34.5	301-311	1.37-1.29	700	75	35.5-36.5	

\* This noise of the product is the value which was measured at the acoustic room. Actually, in the established condition, that undergo influence by the echoing of the room and so that become bigger than the display numerical value .

## ■ PERFORMANCE

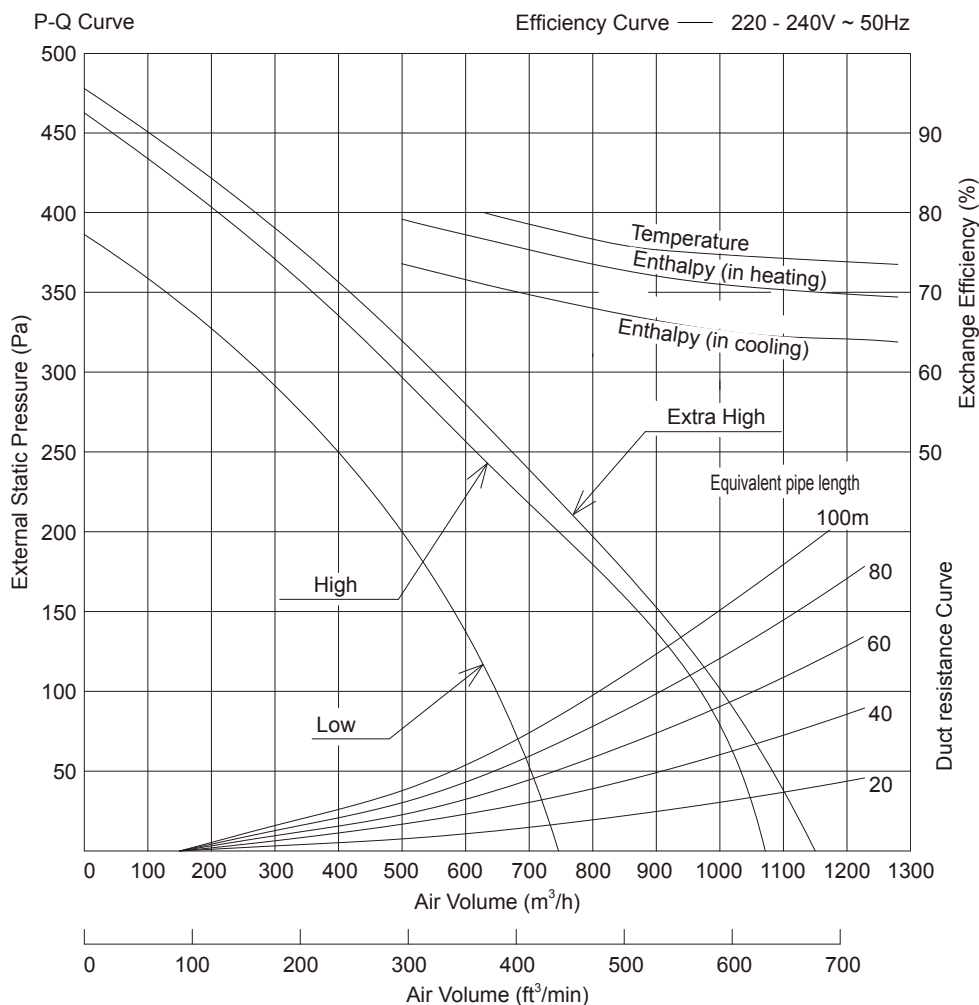

\* When friction coefficient of pipe (duct) :  $\lambda=0.02$

Use conditions	
Outdoor air conditions	Temperature range -10°C ~ 40°C Relative humidity 85% or less
Indoor air conditions	Temperature range -10°C ~ 40°C Relative humidity 85% or less
Installation requirements	Same as the indoor air conditions
* Indoor air here means air in air-conditioned living rooms. Its use in refrigerators or other places where temperature can fluctuate greatly is prohibited even if a temperature range is acceptable.	
<b>Example</b>	Indoor air conditions
During cooling period	Temperature 27°C Relative humidity 50%
During heating period	Temperature 20°C Relative humidity 40%

## ■ MOTOR SPECIFICATIONS

Type	4 Poles open type induction motor
Rating	Cont.
Insulation Class	class B
Temperature Rise	under 80 K
Surrounding Temperature	-10°C ~ 40°C
Insulation Resistance	over 1M $\Omega$ (by DC500V)
Withstand Voltage	AC 1,500V for 1min
Input (Reference)	218-232 W (220-240V)
Output (Reference)	180 W (220V)
Diameter	$\varnothing$ 123 mm
Weight	3.5 kg
Lot 11	Applicable (Over 125W)

- The Input, the current and the exchange efficiency are values at the time of the mentioned air volume.
- The noise level shall be measured 1.5m below the center of the unit.
- The temperature exchange efficiency averages that of when cooling and when heating.



### 3. WIRING DIAGRAMS

#### 3-1. UTZ-BD025C

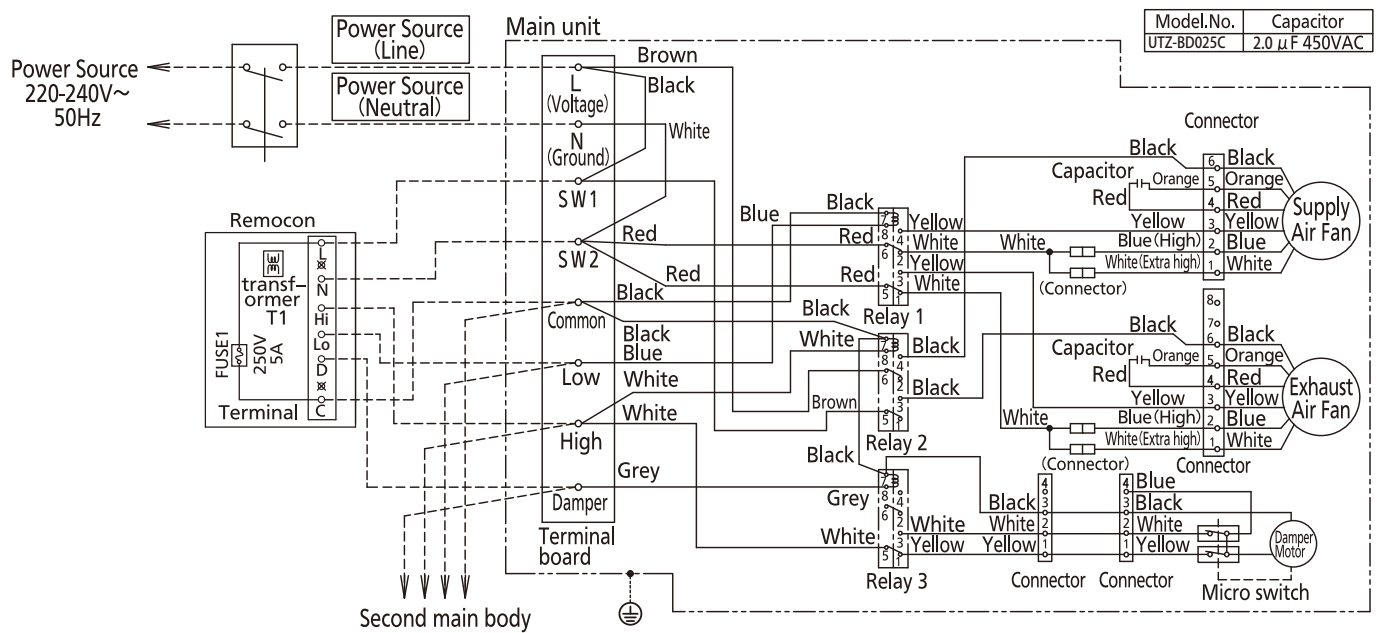

#### 3-2. UTZ-BD035C, UTZ-BD050C

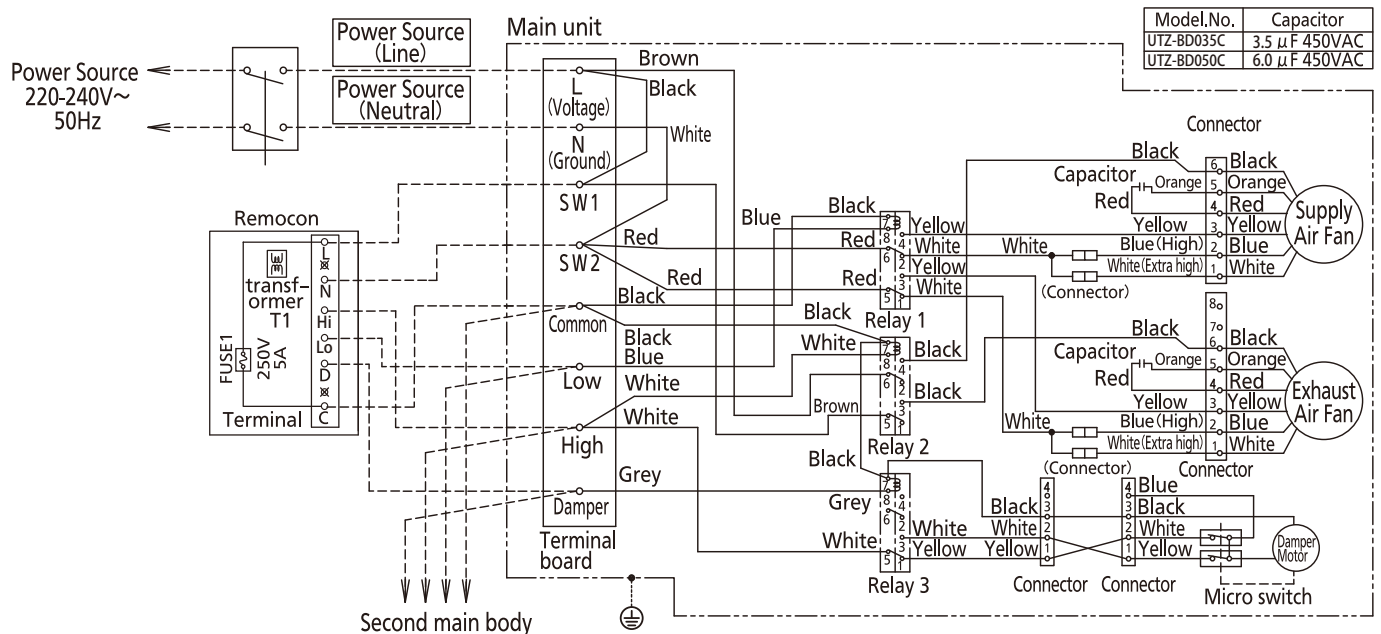

### 3-3. UTZ-BD080C, UTZ-BD100C

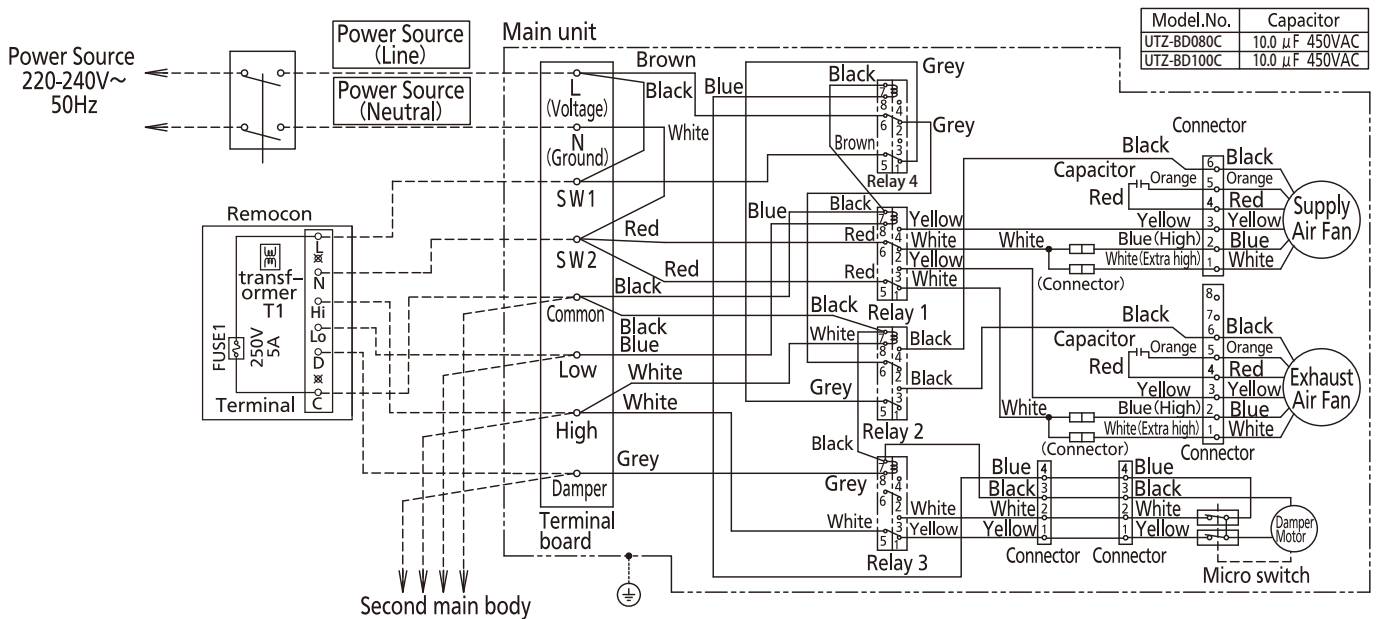

### ■ ELECTRIC WORKS

If a large volume of air is required or a long duct is used, switch the wire connection from Low to Extra high according to the following steps:

- Remove two screws securing the cover of the electrical components box, and open the cover .
- In the electrical components box, change the connection of fan motor leads from High to Extra high.

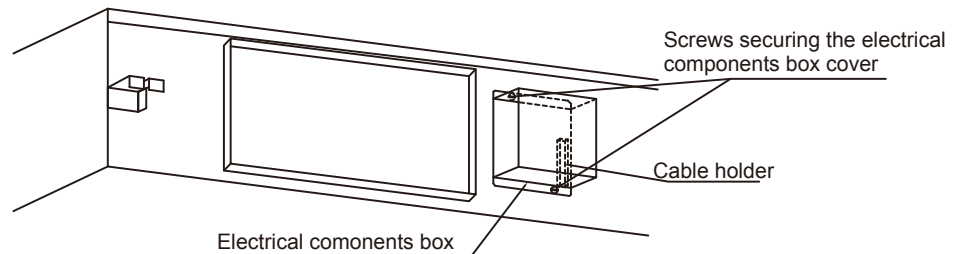
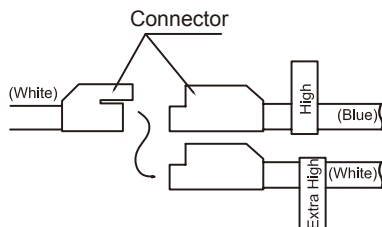

## 3-4. INTERLOCKED CONNECTION TO AIR CONDITIONER

- Operation is performed simultaneously with the air conditioner.
- Setting changes are made by energy recovery ventilator switch.

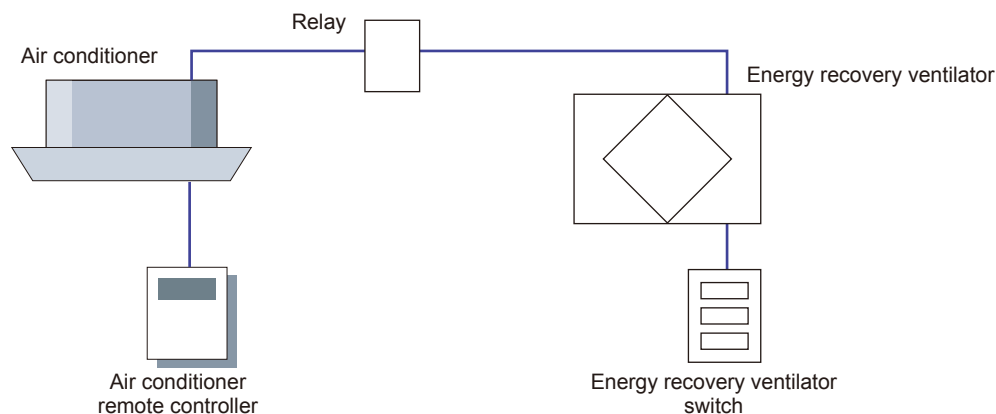

### ■ CONNECTION METHOD

- Perform electrical work in accordance with the laws and regulations of each country.
- Check whether or not there is an external output and the necessary connector terminals at the air conditioner using the air conditioner technical manual beforehand. The external output (operation status output) of the indoor unit PC board is used.
- There is a type of external output from the air conditioner which requires an external power source and a type which does not require an external power source. The type is different depending on the model.
- The allowable voltage/current of the external output circuit from the air conditioner varies depending on the model. Check it with the air conditioner technical manual.
- Do not connect the energy recovery ventilator power source (AC220-240V) to the external output terminals from the air conditioner.
- Regarding the relay circuit, select the necessary capacity from the allowable current value of the external output terminals and the current value of the energy recovery ventilator and connect.

When there is no requirement on the filter cleaning display (ErP Lot6), following connections are allowed.

#### (1) When energy recovery ventilator operation is unnecessary

For energy recovery ventilator, airflow switching and heat exchange ventilation / normal ventilation switching cannot be performed.

The figure shown below indicates the operation with airflow HIGH and heat exchange ventilation.

Remote controller attached with the energy recovery ventilator cannot be used.

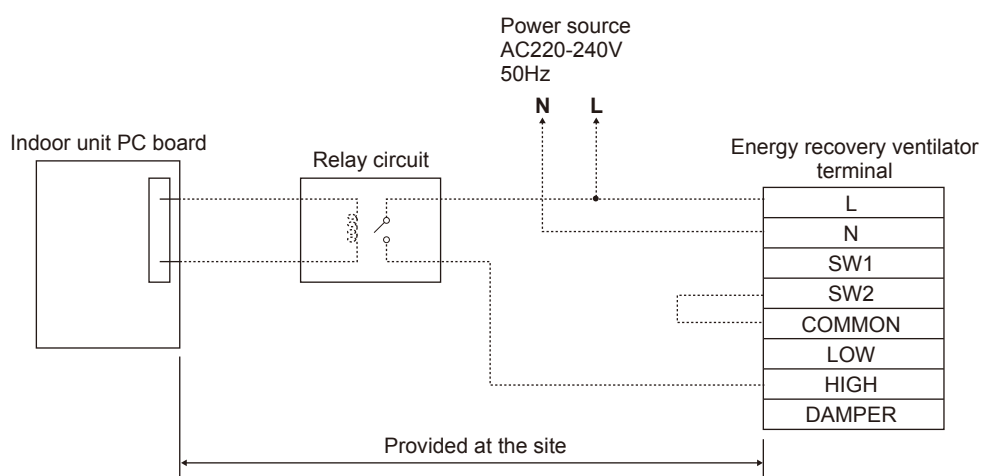

## (2) When you want to operate using the energy recovery ventilator switch

Operation is performed simultaneously by air conditioner remote controller even when the energy recovery ventilator switch is in the OFF state.

The energy recovery ventilator can be operated by energy recovery ventilator switch even when the air conditioner is in the stopped state.

Remote controller attached with the energy recovery ventilator cannot be used.

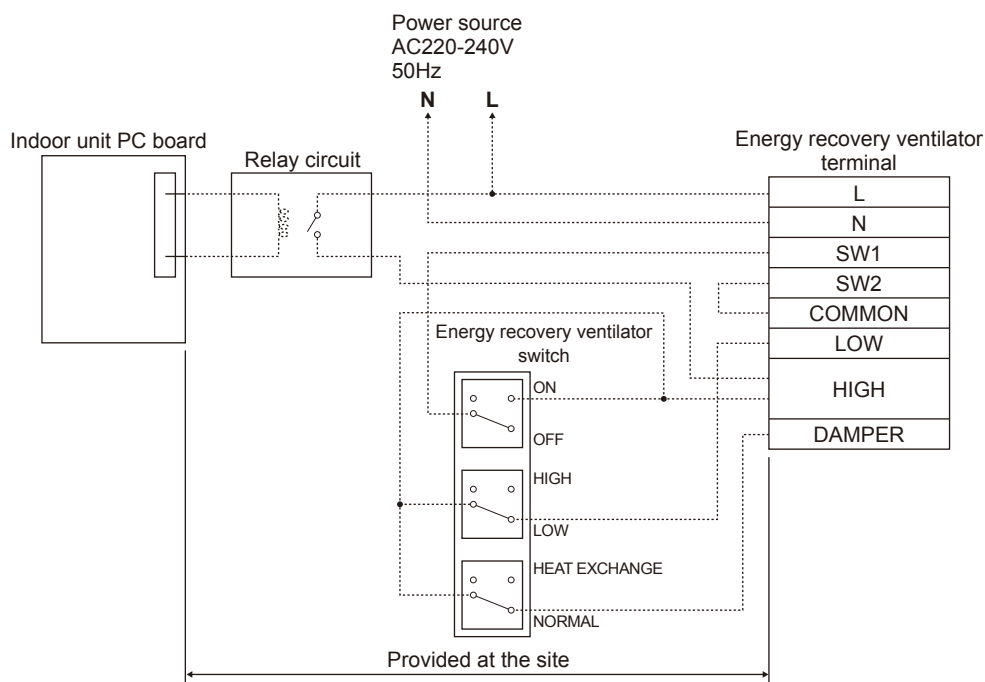

### ⚠ Do not make connections to multiple indoor units by duct direct connection system.

Dust may be dispersed depending on the operation condition of the air conditioner.

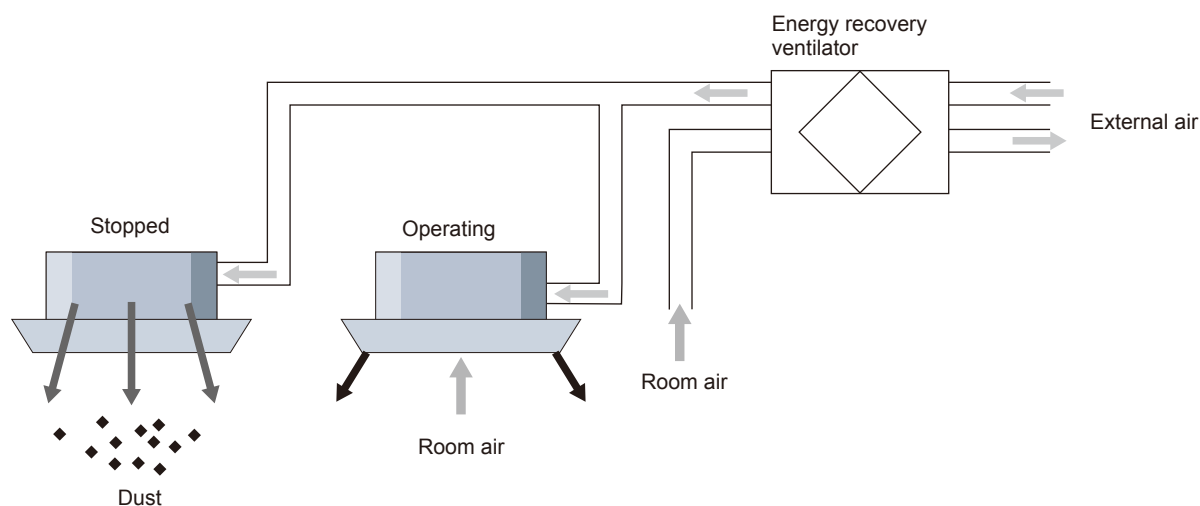

## 4. DESIGN SECTION

### 4-1. ABOUT HEAT EXCHANGE UNIT

#### 4-1-1. BASIC ENGIN

##### ■ BASIC PRINCIPLE AND STRUCTURE OF THE HEAT EXCHANGER

###### ● Basic principle of a heat exchanger

The basic principle of a heat exchanger is as indicated below. As heat moves from a high-temperature area to a low-temperature area together with humidity, the heated and moist air moves the heat and humidity to colder and drier air by passing through a heat-exchange element.

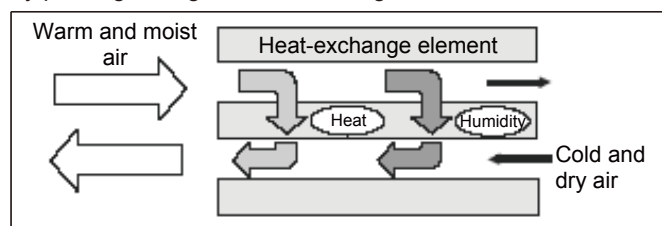

###### ● Function of a heat exchanger

A heat exchanger effectively recovers cooled or heated room temperatures and simultaneously ventilates air.

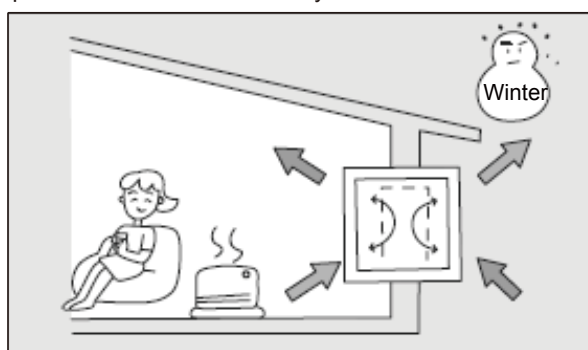

###### ● Mechanism of a heat exchange element

The heat exchange element can allow the exhaust air from inside and the fresh air from outside to transmit temperature and humidity without being mixed up.

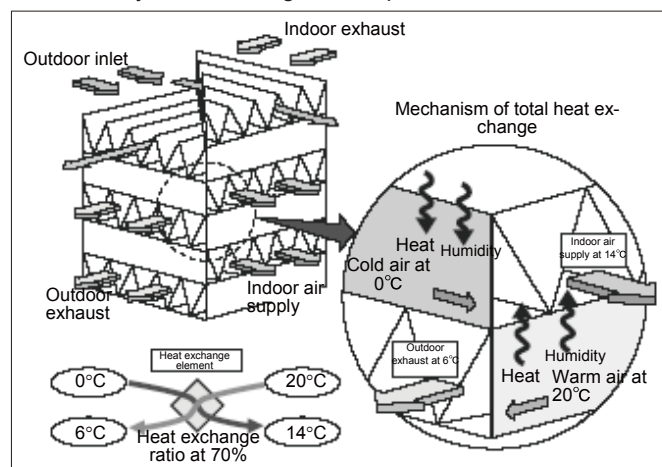

##### ■ ADVANTAGES OF THE HEAT EXCHANGE ELEMENT

###### ● The height of the heat exchange element reduced by 20%

The upper and lower protrusions have been cut out (see the figure below). The newly adopted counter-flow heat exchange system has made the entire unit much thinner from 287mm to 230mm, and realized the same performance as in the conventional cross-flow heat exchange element.

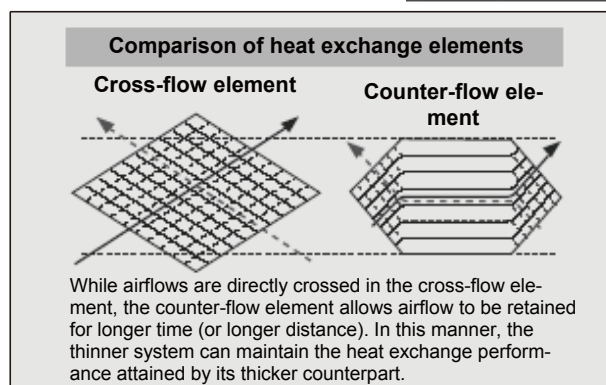
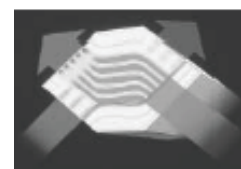

###### ● Total heat exchange efficiency improved by 6%

The adoption of the counter-flow element has improved the total heat exchange ratio by about 6%, significantly contributing to energy saving.

###### ● Long-life heat exchange element

By adopting nonwoven fabric filter with excellent dust collection efficiency and improving the air course shapes, a long-life heat exchange system has been realized, which does not require regular cleaning of the heat exchange element.

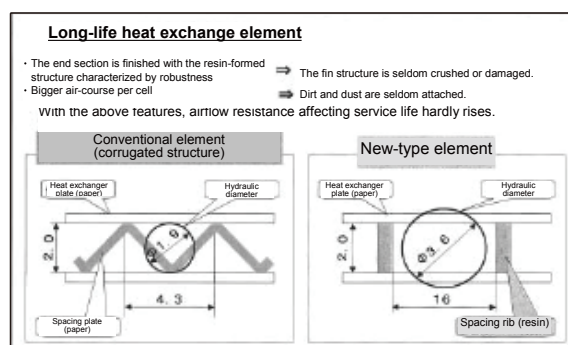
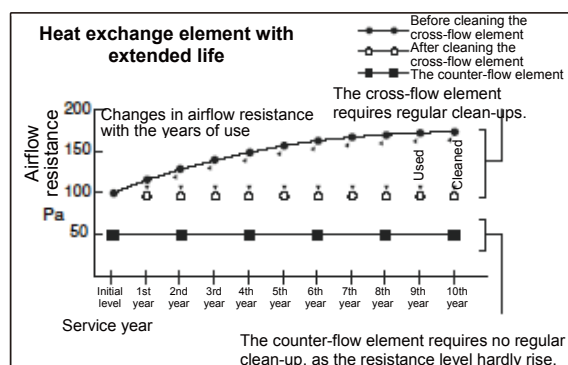

# 4-1-2. INTERNAL STRUCTURE

## HEAT EXCHANGE VENTILATION

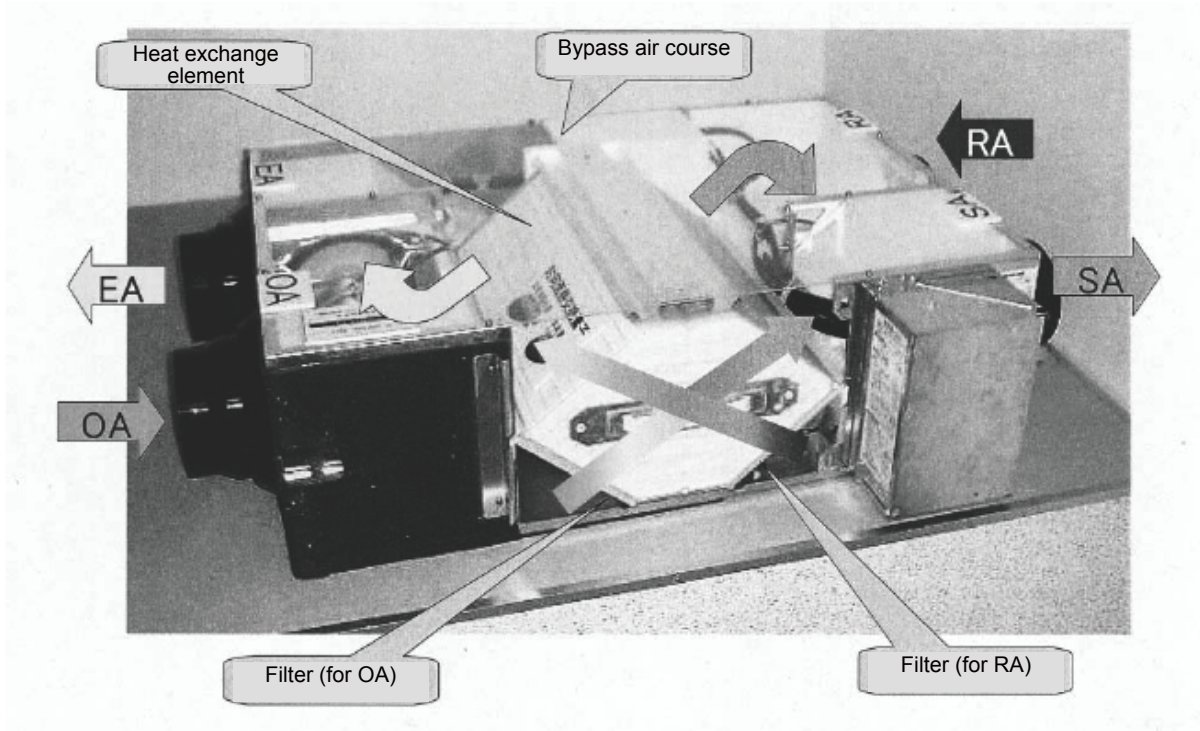

## NORMAL VENTILATION

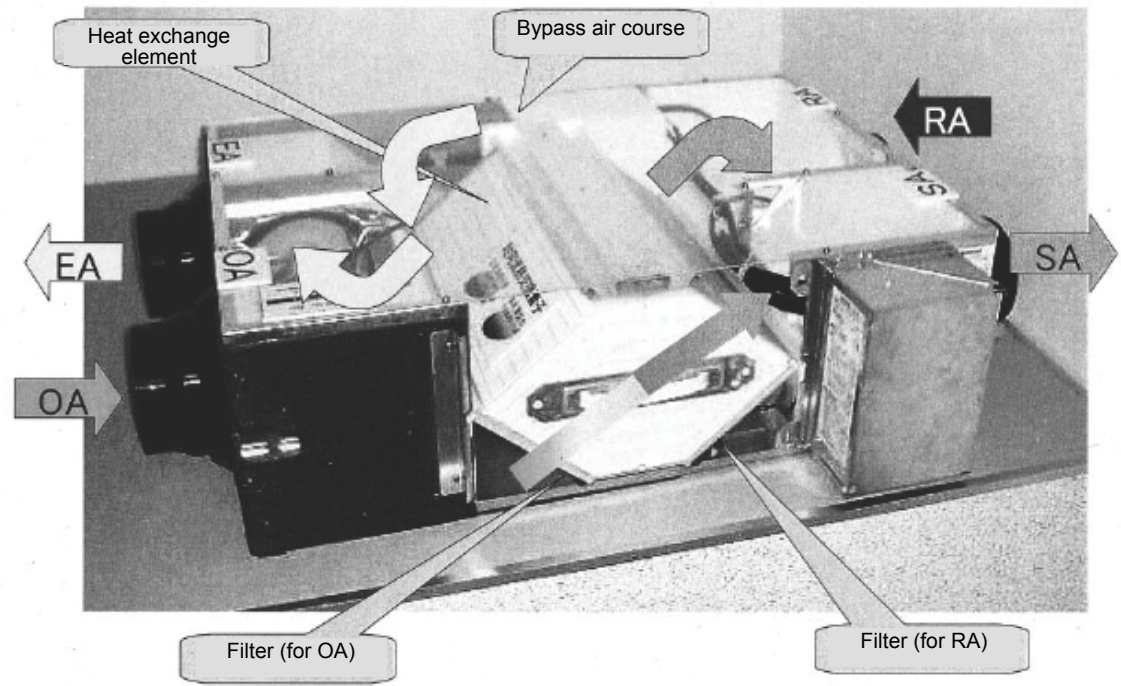

## 4-1-3. HEAT EXCHANGE VENTILATION AND NORMAL VENTILATION

### ■ HEAT EXCHANGE VENTILATION

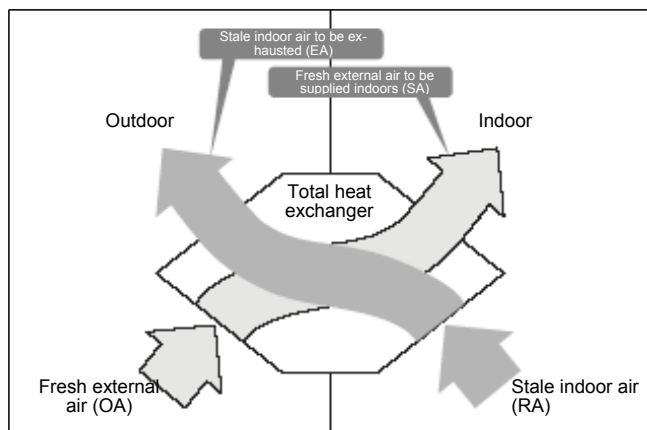

External air is heat-exchanged with indoor air, and supplied indoors after the temperature is made closer to the room temperature

### ■ NORMAL VENTILATION

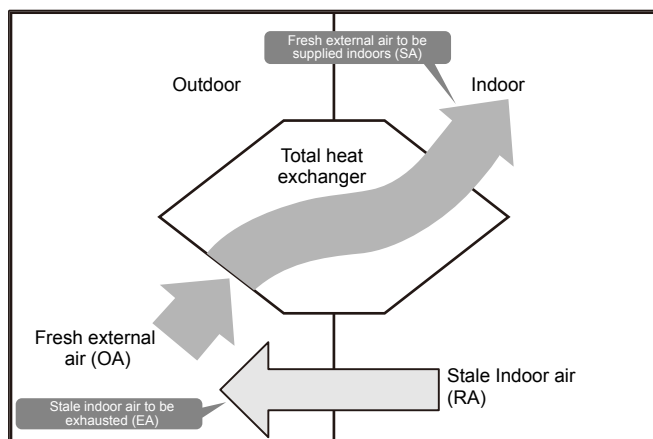

External air is let in without heat-exchange with indoor air.

### ■ ATTENTION

- When the heating function is on during winter, do not use "normal ventilation." The dew condensation will take place in the unit, which may result in stains on the ceiling, etc.

## 4-2. NEEDS FOR VENTILATION

### 4-2-1. OBJECTIVES AND EFFECTS OF VENTILATION

#### ■ EFFECTS OF VENTILATION

Ventilation is not simply designed to exhaust stale air. It also has deodorizing, dust removal, dehumidification, and room temperature adjustment functions, in addition to exchanging air.

##### (1) Ventilation function

Ventilation supplies fresh air required to sustain our normal breathing and exhausts stale air; as well as supplies oxygen required for combustion and prevents imperfect combustion.

##### (2) Deodorizing function

A ventilation fan can quickly exhaust unpleasant odor derived from various sources, and create comfortable environment.

##### (3) Dust removal function

Dust floating in the air may accompany invisibly tiny various harmful bacteria, etc. Dust and dirt should thus be exhausted from room to create hygienic and comfortable environment.

##### (4) Dehumidification function

Humidity in a house is not limited to the bathroom. Moisture is also emitted from human bodies and combustion appliances. Particularly, in recent years, heating in a highly airtight structure has caused dew condensation, resulting in mold growth and even damaging floors and walls, etc. Eliminating interior humidity through ventilation will create comfortable and healthy conditions for both human bodies and buildings.

##### (5) Room temperature adjustment function

At summer nights, ventilation accompanied by refrigeration air conditioning can eliminate warm room air by the ventilator, and let in cool outdoor air. Circulation-type ventilators can also maintain the room temperatures, realizing highly efficient heating in winter.

#### ■ EFFECTS OF STALE AIR ON BUILDING

##### ● Stains on interior surfaces

Brand new white ceilings, walls, furniture, and decorative items may turn yellowish in a year or two, due to tar contained in cigarettes and floating dust.

##### ● Beware of humidity

Humidity emitted from one human body is said to amount to about two liters a day. In highly airtight modern structures, in addition to bathrooms, which are almost always humid, many places can remain highly humid, such as living rooms, closets, storerooms, and under-floor areas, etc. If left unattended, mold and ticks will soon appear, and the wood may be more likely to be rotted. In addition, heating will also accelerate dew condensation, which may further damage portions behind walls and floors, which are not readily visible.

#### ■ NEEDS FOR AIR SUPPLY

Ventilation is to exchange indoor air with outdoor air. When ventilation is performed by a ventilating fan (generally for the exhausting function), if air inlet is limited (in a room or a building), the capabilities of the ventilator may be greatly reduced, or the indoor pressure may be lowered, causing drafts and noises, as well as making it difficult to open or close doors.

##### ● Sizes and locations of inlets

###### (1) Sizes of air inlets

Required sizes of inlets may vary, depending on the sizes of apertures and openings of the buildings. The effective opening area (cm<sup>2</sup>) should be 0.7 times the ventilation airflow (m<sup>3</sup>/h), with the internal and external pressure difference set at 10Pa.

Effective opening area  $\alpha A$  (cm<sup>2</sup>) = 0.7 × airflow (m<sup>3</sup>/h)

As a reference, the following computation formulas are proposed in the ventilation/air-conditioning engineering standards.

$\alpha A = 0.68V - S \alpha A'$  (in the case of  $\Delta P_{\max} = 10\text{Pa}$ )

$\alpha A = 0.39V - S \alpha A'$  (in the case of  $\Delta P_{\max} = 30\text{Pa}$ )

$\alpha A$ : Effective opening area (cm<sup>2</sup>) of dedicated inlets

$V$ : Effective ventilation air volume (m<sup>3</sup>/h)

$S$ : Gross floor area of a building (m<sup>2</sup>)

$\alpha A'$ : Air-tightness of a building (cm<sup>2</sup>/m<sup>2</sup>)

A ventilating fan has an exhaust capability specified in the catalog, for which, however, the amount of air exhausted by the fan needs to be supplied from the inlet.

In other words, if the air-inlet is small, sufficient air cannot be supplied indoors, resulting in insufficient ventilation capacities. The air-inlet should generally be larger than the installation area for the ventilation fan. As the inlet area gets bigger, the air velocity there will be reduced, making it less uncomfortable for people near it.

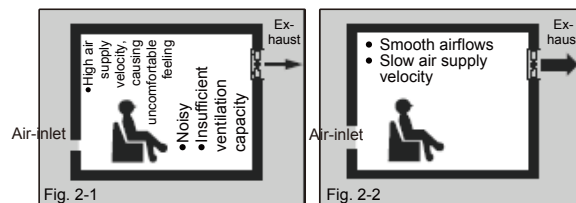

Fig. 2-1

Fig. 2-2

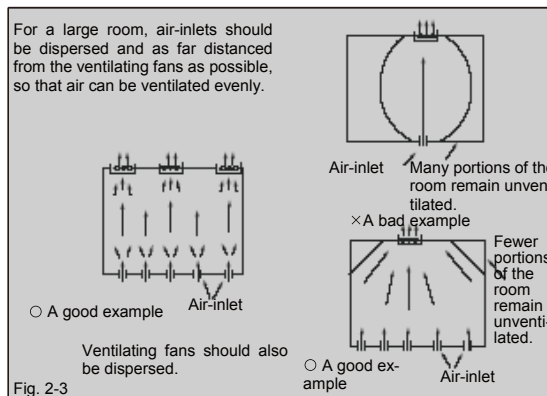

Fig. 2-3

###### (2) Locations of exhausts (ventilation fans) and air-inlets

In the case of general ventilation, air-inlets should be located as far detached from ventilating fans as possible. On the other hand, in the case of local ventilation, the air-inlet should be as close to the ventilating fans to minimize any effects to the surrounding areas.

###### (3) In bathrooms,...

When ventilating fans are installed in bathrooms, etc., air-inlets should always be installed (except for simultaneous exhaust/supply systems). Otherwise, ventilating air volumes may be reduced, or the sealing water may be disrupted in shallow traps, causing the sewage stench to flow into the room.

(4) In rooms where half-enclosed combustion apparatus are used  
In a cold region, when a stove with a chimney is installed without proper air-inlets, and ventilation fan is put into operation, the chimney may function as an air-inlet and let the exhaust into the room, causing a dangerous situation.



## 4-3. METHODS OF VENTILATION

Ventilation can be divided into natural ventilation based on natural conditions and mechanical ventilation based on mechanical power.

### NATURAL VENTILATION

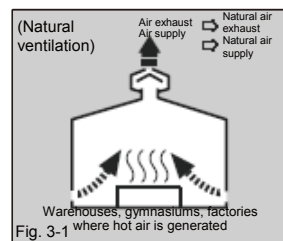

This ventilation is based on pressure derived from external winds and the outdoor and indoor temperature differences. However, as natural ventilation is weaker than mechanical ventilation and may be greatly affected by natural conditions, significant results cannot be expected

### MECHANICAL VENTILATION

#### Methods of mechanical ventilation

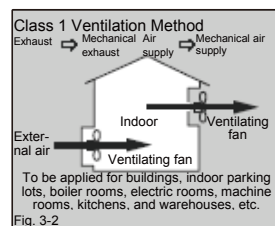

As this method is based on enforced ventilation with ventilating fans and air blowers, etc., it is capable of generating stable amounts of ventilation at required timing, compared with natural ventilation.

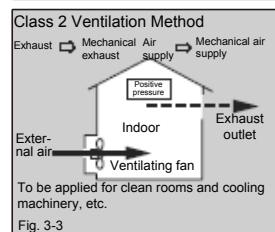

\* Highly contaminated rooms should remain in negative pressure to prevent contaminated air from leaking into adjacent rooms and corridors (Class 1 or Class 3 Ventilation). On the other hand, for rooms that need to be kept clean, positive pressure should be maintained to prevent intrusion of contaminated air (Class 2 Ventilation).

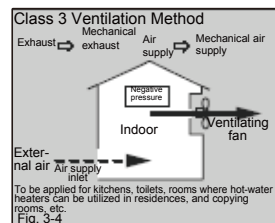

#### Total ventilation and local ventilation

##### Total ventilation

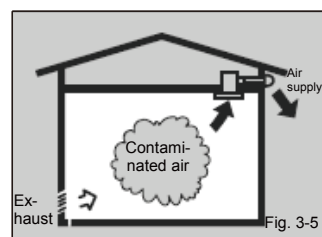

This ventilation is designed for an entire house and for exchanging the entire air in the house (Fig. 3-5).

The total (general) ventilation can be categorized into the following three types.

- Individualized ventilation system  
The amount of ventilation required for each room can be satisfied by installing ventilation facilities at each room.  
.....
- Total ventilation system  
The total amount of ventilation for the entire building can be satisfied by utilizing local exhaust facilities and installing natural air-supply inlet at each room. E.g., local exhaust facilities + natural air-supply inlets, etc.
- Central ventilation system  
A single ventilation unit can satisfy the amount of ventilation required for multiple rooms and the entire building. ....

##### Local ventilation

This type of ventilation is performed for particular spots in a house (rooms or parts).

##### a) Local exhaust

Local exhaust is performed for particular places in which contaminants (combustion gases, humidity, smoke, and smell, etc.) may be generated (Fig. 3-6).

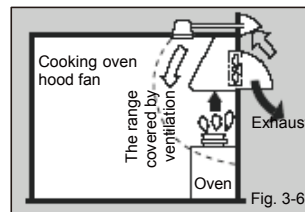

(Ohmsha, Ltd., Ventilation, the Society of Heating, Air-Conditioning and Sanitary Engineers of Japan)  
This kind of ventilation is applied specifically for kitchens, bathrooms, and toilets, etc.

##### a) Room ventilation

Individualized ventilation designed for single rooms, etc. (When individualized ventilation systems are installed in all rooms, the entire setup can be referred to as total ventilation.)

# 4-4. DESIGN PRECAUTIONS

## 4-4-1. CAUTION ON SAFETY

### SAFETY PRECAUTIONS

Described below is what you are supposed to observe to prevent dangers to the users or other people as well as damage or loss of the property.

- The degrees of danger or damage that is likely to occur due to the wrong use ignoring the indications are categorized for explanations as marked below.

	<b>DANGER</b>	The column with this mark shows "Impending Danger of Death or Serious Injury."
	<b>WARNING</b>	The column with this mark shows "Conceivable Threat of Death or Serious Injury."
	<b>CAUTION</b>	The column with this mark shows "Likelihood of Damage or Loss to Materials Only."

- Kinds of the items to be observed are categorized for clarification with the following pictorial symbols. (The marks described below are samples.)

	This pictorial indication shows "Prohibited."
	This pictorial indication shows "Forced Execution."

### CAUTIONS FOR INSTALLATION

#### WARNING

- Do not install, move, or relocate the unit by yourself without contacting your dealer or professional installer. Improper installation could cause a drop of the unit, an electric shock, or a fire.
- Ask the sales office or the engineering shop to perform the work.
- The external air intake opening should not be positioned where discharged air may directly enter it. A situation like this will lead to the room being contaminated and this may pose a health risk.
- The external air intake opening should be positioned away from the exhaust openings of combustion gasses. The intake of such gasses could lead to a lack of oxygen in the room.

#### CAUTION

- Install the unit inside the heat-insulating walls (in the space insulated from the open air).   
If you install it outside (in the space equivalent to the open-air conditions), dew is condensed inside the unit body in the winter season, causing electric shocks or dew condensation water to drops, etc.
- Install at a stable place of sufficient strength. Please note that there might be some places not strong enough to install due to the building structure.
- Provide an exclusive circuit breaker. Depending on the environment for installation, it becomes necessary to install an earth leakage breaker. Unless the earth leakage breaker is installed, it could cause an electric shock. Ask the sales office of the engineering shop to perform the work.
- Do not install in locations where harmful or corrosive gasses may be present (e.g. acidic, alkali, organic, solvent, paint gasses, etc. from machinery or chemical plants, etc.). Installation in such a location could cause a gas-poisoning and a fire.
- Carry out GND work. Never connect the GND wire to a gas pipe, a water supply pipe, a lightning conductor, or a GND line of a telephone, etc. An incomplete GND wire connection is likely to cause an electric shock.
- If the unit is accompanied by water drainage, make sure that the duct is installed properly. If it is not installed properly, the building is likely to be flooded, wetting the household effects.
- Do not install the unit in locations with large amounts of oily smoke. If you use the unit in such a location, the filter or the heat exchange element gets clogged with oily substances, and unable to be utilized.
- Do not install the unit in high humidity locations, such as bathrooms. Doing so may cause an electric shock or a breakdown of the unit. (Excluding any humidity-resistant models)

### CAUTIONS FOR OPERATIONS

#### DANGER

- Do not use as an air circulators for open-type burners (heaters).   
When gas or oil stoves are used in the home, separate equipment for circulating the air should be used.

#### WARNING

- When any abnormal condition (scorching smell, etc.) is found, stop the operation immediately and keep the exclusive circuit breaker "OFF."
- If you continue the operation without removing the cause, it could cause a mechanical breakdown, an electric shock, or a fire.
- When the system needs a repair, consult the sales office or the engineering shop.
- Do not push a finger or stick into the open-air inlet or the exhaust outlet. A fan rotating with a high rpm will injure you.
- If combustible gas leaks from the unit, ventilate the room by opening windows. If operation were to be attempted in such a situation, sparking at electrical contact points could cause an explosion.
- Modification of the system is strictly prohibited.
- Improper repair could cause an electric shock or a fire.
- When the system needs a repair, consult the sales office or the engineering shop.
- Netting or something similar should be provided at the external air intake opening to prevent birds, etc. interfering with the unit. Nests or other foreign objects should be removed. That could lead to a lack of oxygen in the room.

#### CAUTION

- Combustion apparatus should not be placed allowing a direct exposure to wind of the unit. Incomplete combustion could occur on the apparatus.
- Do not blow directly against animals or plants. Likely to cause bad effects on animals and plants.
- Please check the intended uses in detail for such special purposes as preservation of foods, flora and fauna, precision devices, or work of art, etc.
- For special purposes, please conduct thorough checks in advance. Otherwise, it could cause deterioration of quality or other problems.
- If the unit is not used for a long period of time, keep the exclusive circuit breaker "OFF" for safety reasons. If the power is left on, any build-up of dust could cause a heat generation or a fire.
- Do not wash the unit with water. It could cause an electric shock.
- Do not handle switches with a wet hand. It could cause an electric shock.
- Do not use a spray containing combustible gas near the unit. It could cause a fire.
- Do not use the unit outside the rated voltage. It could cause a fire or an electric shock.
- Do not incline the unit when taking it out. Otherwise, water remaining inside is likely to drop and wet the furniture or other properties.
- Ask the sales office or the engineering shop to perform the work.

### CAUTIONS FOR MAINTENANCE

#### WARNING

- When the filter and the heat exchange element is to be cleaned up, turn the unit off and keep the exclusive circuit breaker "OFF."   
Cleaning should never be done while the internal fans are running with high speed. And when using a stepladder, etc., make sure to fix it properly.

#### CAUTION

- Do not use benzene or metal brush, etc., when cleaning the filter and the heat exchange element. Otherwise, the unit will get unfit for use.
- Use gloves when cleaning the filter or the heat exchange element. Doing so will reduce possibilities of injuries.
- The filter should be cleaned regularly. Dust or dirt building-up on it can lead to a lack of oxygen in the room.

## 4-4-2. INSPECTION OPENING AND INSTALLATION MODELS

### ■ INSPECTION OPENING

Never fail to make the inspection opening at the specific place on the ceiling, so you can perform the constant cleaning, or the equipment checking of, the filter, the heat exchange element, and the humidifier.

• The inspection opening shown below is necessary to clean the heat exchange element and the filter once or twice a year. If not cleaned, they are likely to get clogged, resulting in deteriorated performance.

• Installation Model .....

• Inspection Opening .....

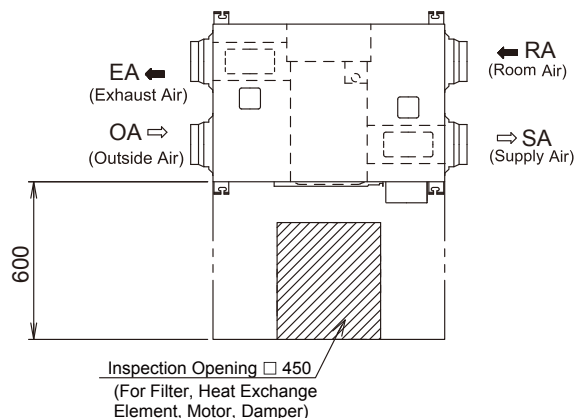
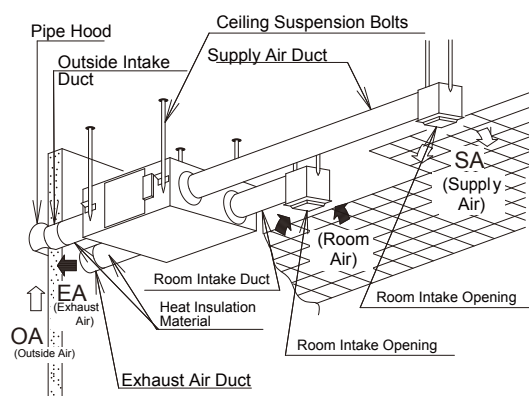

## 4-4-3. USE ENVIRONMENTS

### DEW CONDENSATION PREVENTION

Our heat exchange unit has been confirmed not to cause dew condensation water to drop under the following conditions. If the unit is to be used in severer conditions than the following, dew condensation water may drop.

JIS B 8628 Total Heat Exchanger Attachment 5 (Regulation) Dew Condensation Test Methods

Category	Indoor Conditions		Outdoor Conditions		Operation Conditions	Testing Time (h)
	Dry-bulb temperature	Wet-bulb temperature	Dry-bulb temperature	Wet-bulb temperature		
Cooling in Summer	22±1	17±2	35±1	29±2	On	6
Warming in Winter	20±1	14±2	-5±2	—	On	6
Warming in Winter	20±1	14±2	-15±2	—	Off	6

nit: °C

In winter, the standard type should be used in the "Heat Exchange" mode. If it is used in "Normal Ventilation" in winter while the heater is on, the unit may develop dew condensation, resulting in the condensation water on the ceiling, which will cause stains, short-circuits in electric wiring, and fault current.

(Caution) Models designed for commercial use cannot be utilized for residential use due to the different conditions these models should satisfy. (Otherwise, dew condensation and serious electric accidents may ensue. If such applications are inevitable, please contact us in advance.)

#### (1) Prevention of Dew Condensation on Product Surfaces

- When the humidity and the temperature are high around the product under low outdoor temperatures, dew may be condensed on the surface of the product.
- The following graph indicates marginal conditions for dew condensation on product surfaces in terms of temperature and humidity around the product, and outdoor temperature.

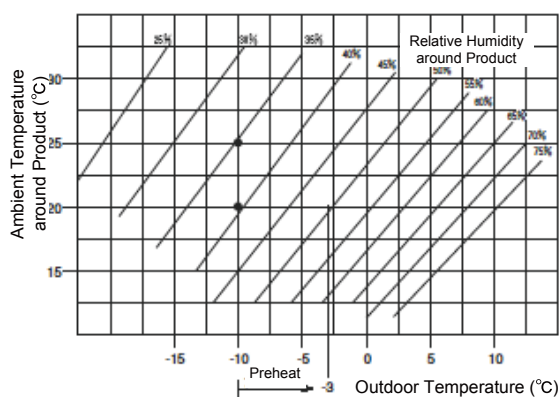

- The product should be used in conditions not exceeding the relative humidity around the product, as specified in the above graph.

**Example 1** When the outdoor temperature is -10°C and the ambient temperature around the product is 20°C, no dew will be condensed until the ambient relative humidity around the product reaches 40%, as indicated in the graph. However, when the ambient temperature around the Product is 25°C, the ambient humidity around the product should be less than about 35%, as indicated in the graph.

**Example 2** When the outdoor temperature is -10°C and the ambient temperature around the product is 20°C, and if the ambient relative humidity around the product may fluctuate between 40% and 50%, dew may be condensed on the product surface. In this case, the outdoor temperature needs to be preheated from -10°C to -3°C.

#### (2) Prevention of dew condensation on heat exchange element

- As shown in the figure below, suppose a high temp absorbing air condition A and a low temp absorbing air condition B are plotted on the air line figure, then a high temp air A is heat-exchanged by the unit and goes out of the saturation curve as shown by Point C. In this case, the unit will be dewed or frosted. To avoid this, you are required to heat a low temp air B up to B' so as to get C' below the saturation curve, before using the unit.

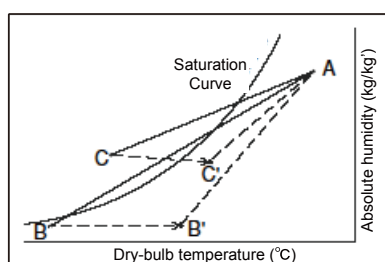

### PREVENTION OF INSECT INTRUSION

The heat exchange unit takes in fresh outdoor air. Thus, if there are insects in the outdoor environment, they may be sucked in through the external pipe hood.

Although the unit is equipped with a filter that can trap bigger dust and dirt, small insects may not be captured by the filter and taken into the room through the filter perimeters and the frame apertures.

In addition, when the unit is in the "Normal Ventilation" mode and the operation is stopped, the air course on the exhaust side and indoor area is connected even though no wind is blowing. In this situation, intrusion of insects may take place in very rare occasions.

As the emergence of insects may depend on various natural conditions, we recommend users to apply medium-performance filters (to be purchased separately) in environments where there are many insects or where insects are likely to swarm, as the exhaust/intake openings are close to street lamps, etc. In addition, it is also recommended that the unit should be turned off in the "Heat Exchange Ventilation" mode. However, it is almost impossible to completely prevent intrusion of extremely small insects. Users are thus advised to consider full-scale insect prevention measures, such as installation of filter boxes (to be separately purchased by the users) on the designing stage.

When the unit is in operation in the "Normal Ventilation" model, it should be shifted to the "Heat Exchange Ventilation" mode first, and then put to "Stop" after 30 seconds.

The medium-performance filters should be built in the unit, available for the ceiling-mounted, the ceiling-mounted with a humidifier, and the ceiling-suspension cassette types of the products, to be separately purchased.

Although these filters may be equipped after installation of the unit, please be noted that the supply air volume may be reduced (about 10%). (The filters are not available for specified and older models.)

### PREVENTION OF EXTERNAL WIND INTRUSION

If the unit is turned off in the Normal Ventilation mode, the external wind is likely to enter indoors. It is thus recommended to turn off the unit in the Heat Exchange Ventilation mode.

In cold regions, or areas where frost damages may take place or strong winds may blow, external winds may enter indoors when the unit is turned off. In order to prevent these inconveniences, it is recommended to install an "electric damper (to be separately purchased by users)" on the side of the external duct.

For ducts with  $\phi 100$  and  $\phi 150$ , please use the electronic dampers (electric shutters) we provide; for ducts the diameter of which are  $\phi 200$  and  $\phi 250$ , please use those offered by PENTEK.

Contact: PENTEK. (TEL: 0568-81-0510)

### PREVENTION OF SALT EROSION

Our heat exchange ventilation units are not equipped with specific countermeasures against salt erosion. The following measure may be proposed, but should require thorough design planning about the service life of the salt erosion prevention filters, etc.

( ) In case salt damages need to be prevented in seaside buildings, it is recommended to install salt erosion prevention filters on the external intake side (the OA side), which should be separately purchased by users. In this case, it is necessary to confirm that the designed airflow can be secured, as the intake airflow will be reduced by the filter. If it is found that sufficient airflow cannot be obtained, further considerations will be required.

(As for the salt erosion prevention filters, please contact us separately.)

### INSTALLING THE UNIT UPSIDE DOWN

The ceiling-mounted model can be installed upside down. (The ceiling-mounted model with humidifying and humidity-resistant types, as well as the cassette types cannot be installed upside down. For more details, please check the respective catalogs.)

### INSTALLATION LOCATIONS

Do not install the unit body and indoor intake openings in locations where harmful or corrosive gasses may be present (e.g. acidic, alkali, organic, solvent, paint gasses, etc. from machinery or chemical plants and research laboratories, etc.).

(Installation in such a location could cause gas-poisoning, corrosive deterioration within the unit, and a fire.)

### ODOR PREVENTION

- Water-soluble gasses cannot be used, as they may be freely ferred with moist, inside the heat exchange element.
- Acid gasses cannot be used, as they may be accumulated within the heat exchange element, and causing damages.
- Bathroom (toilet) ventilation facilities should be separately installed.
- Although the unit is designed to prevent mixture of fresh external air and indoor air with packing and sealing materials, it is structurally difficult to completely prevent such a mixture.

## 4-4-4. HEAT EXCHANGE EFFICIENCY

### ■ HOW TO CALCULATE HEAT EXCHANGE EFFICIENCY

The heat exchange efficiency can be subdivided into the following three categories.

**Temperature (sensible heat) efficiency**

**Humidity (latent heat) efficiency**

**Enthalpy (total heat) efficiency**

The heat recovery rate can be calculated if two of the above are available.

(Temperature efficiency and enthalpy efficiency are indicated in catalogs, etc.)

\* Each exchange ratio can be calculated in the following formula.

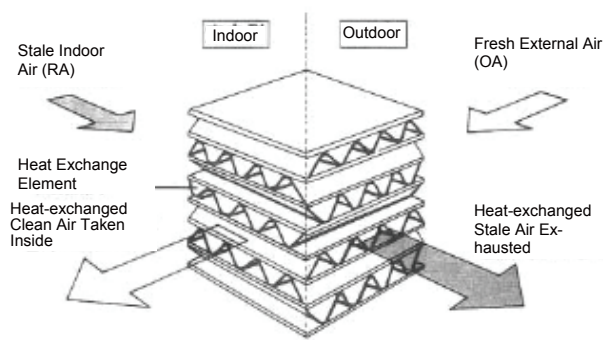

Item	Formula	
Temperature Exchange Effectiveness [%]	Temperature Exchange Effectiveness (%) =	$\frac{\text{External Air Temperature (}^\circ\text{C)} - \text{Internal Supply Air Temperature (}^\circ\text{C)}}{\text{External Air Temperature (}^\circ\text{C)} - \text{Internal Temperature (}^\circ\text{C)}} \times 100$
Enthalpy Exchange Effectiveness [%]	Enthalpy Exchange Effectiveness (%) =	$\frac{\text{External Air Enthalpy (kJ/kg)} - \text{Internal Supply Air Enthalpy (kJ/kg)}}{\text{External Air Enthalpy (kJ/kg)} - \text{Internal Air Enthalpy (kJ/kg)}} \times 100$

#### <How to calculate air conditions after passing through the heat exchange unit>

If the temperature and humidity of the internal air and external air are determined, and if the exchange efficiency of the heat exchange ventilating unit to be utilized is determined, air conditions of the air supplied indoors and exhausted outdoors after passing through the heat exchange unit can be calculated in the following formula.

Intake Side	Temperature	Internal Supply Air Temperature (°C) = External Air Temperature (°C) - (External Air Temperature (°C) - Indoor Air Temperature (°C)) x Temperature Exchange Effectiveness (%)
	Enthalpy	Internal Supply Air Enthalpy (kJ/kg) = External Air Enthalpy (kJ/kg) - (External Air Enthalpy (kJ/kg) - Internal Air Enthalpy (kJ/kg)) x Enthalpy Exchange Effectiveness (%)
Exhaust Side	Temperature	Exhaust Air Temperature (°C) = Indoor Air Temperature (°C) - (Indoor Air Temperature (°C) - External Air Temperature (°C)) x Temperature Exchange Effectiveness (%)
	Enthalpy	Exhaust Air Enthalpy (kJ/kg) = Indoor Air Enthalpy (kJ/kg) - (Indoor Air Enthalpy (kJ/kg) - External Air Enthalpy (kJ/kg)) x Enthalpy Exchange Effectiveness (%)

## TOTAL HEAT EXCHANGE

In the case of ventilation with the total heat exchange mode, the air condition supplied indoors is at point S; in summer, precooling is performed from the external air temperature to the indoor intake temperature, and dehumidifying is performed from the external absolute humidity to indoor intake absolute humidity; and in winter, preheating is performed from the external air temperature to the indoor intake temperature, and the external absolute humidity is further humidified to indoor intake absolute humidity prior to being supplied indoors.

When the total heat exchange is utilized, the calorie to be recovered can be calculated in the following formula.

$$\text{Recovered Total Calorie: } q_T [w] = (\text{Air Specific Gravity } 1.2 [\text{kg}/\text{m}^3]) \times (\text{Process Airflow } [\text{m}^3/\text{h}]) \\ \times (\text{External Air Enthalpy (kJ/kg) - Internal Air Enthalpy (kJ/kg)}) \times \text{Total Heat Exchange Efficiency} \times 0.28 [w \cdot \text{h}/\text{kJ}]$$

## SENSIBLE HEAT EXCHANGE

The following figure indicates various air conditions when external air is taken in through sensible heat exchange. In the case of sensible heat exchange ventilation, the recovered calorie can be calculated in the following formula.

$$\text{Recovered Sensible Heat Calorie: } q_T [w] = \text{Air Specific Gravity } [1.2 \text{ kg}/\text{m}^3 \text{ in the normal condition}] \times \text{Process Airflow } [\text{m}^3/\text{h}] \\ \times \text{Isobaric Specific Heat of Dry Air } (1.006 [\text{kJ}/\text{kg} \cdot \text{°C}]) \times (\text{External Air Temperature } [^{\circ}\text{C}] - \text{Internal Air Temperature } [^{\circ}\text{C}]) \times \text{Sensible Heat Exchange Efficiency} \times 0.28 \\ [w \cdot \text{h}/\text{kJ}]$$

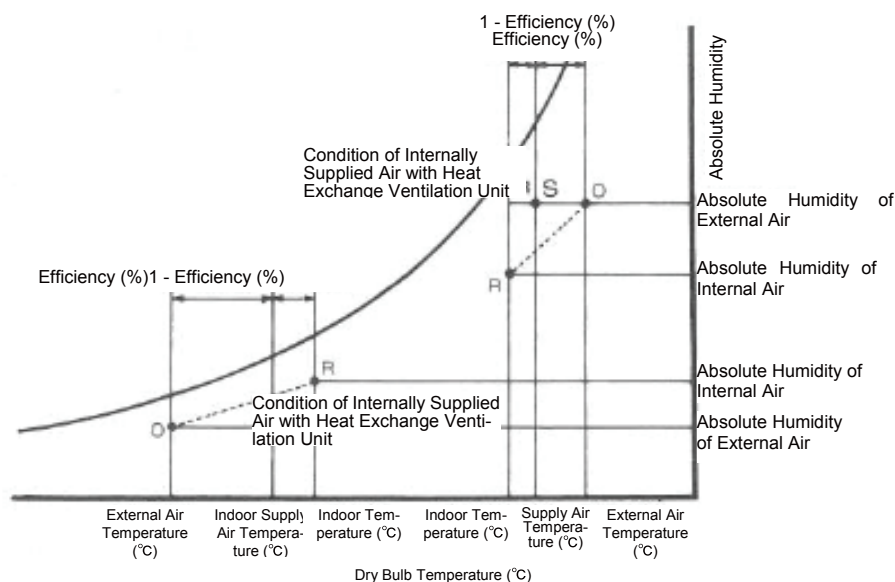

### ⊙ Enthalpy

Referring to how many calories are contained in moist air under a certain condition per 1kg of dry air in it, based on the supposition that the calorie contained in 1kg of dry air at 0°C is 0 kcal. The unit is kJ/kg.

### SI Unit Conversion Table

$$1 \text{ kcal/kg} = 4.2 \text{ kJ/kg}$$

$$1 \text{ kcal/h} = 1.16 \text{ W}$$

## 4-4-5. DUST COLLECTION EFFICIENCY

### ■ DUST COLLECTION EFFICIENCY

Dust collection efficiency refers to the efficiency of a filter for collecting dust and dirt. There are various methods to determine the efficiencies, but the following are three most representative ones.

- \* Mass ratio method: ... Certain amounts of dust are applied to a filter and the collected volume is evaluated by the mass ratio. (For rough dust)
- \* Colorimetric method: .. Certain amounts of dust are applied to a filter and the collected volume is evaluated by the optical transmission ratio. (Medium performance)
- \* Counting method (DOP method):  
Certain amounts of dust are applied to a filter and the collected volume is evaluated by counting the number of particles. (High performance)

The measuring methods for dust collection efficiencies are divided into JIS colorimetric method, NBS colorimetric method, counting method (DOP method), and mass ratio method (AFI).

High values recorded in the mass ratio method may be lowered when converted in the colorimetric method. Please refer to the indication of the measuring method.

- Please refer to the correlation graph below for different dust collection efficiency methods.

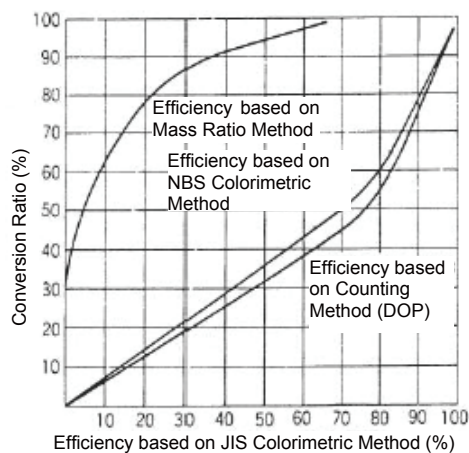

For example, "95%" in the mass ratio method may be indicated as "55%" in JIS colorimetric method.

- ★ Correlation among different dust collection efficiency measuring methods

Although there is no clear correlation among these measuring methods, the above figure is a conversion line graph based on approximated values.

## 4-4-6. NOISE

### ■ UNIT OF NOISE : DB (DECIBEL)

Sound pressure level with a weight corresponding to the "A" scale in the noise level meter is referred to the noise level. The unit is internationally expressed as "dB (A)." In Japan, JIS regulations stipulate that "dB" or "phon" should be used. We use "dB" in this catalog.

### ■ ACCEPTABLE NOISE LEVEL

Recommended noise levels for indoor regular noises

Facility Applications	Noise Level (dB)	Facility Applications	Noise Level (dB)
Concert Hall	21-30	Bed Room, Hospital, Hotel	34-47
Broadcasting Studio	21-30	Small Theater, Conference Room	42 or Less
Large Theater, Church	30 or Less	Factory, Workshop	66-80
Class Room, Library	38-47	Lobby, Laboratory	47-56
Living Room, Drawing Room	38-47	Restaurant, Large Office	42-52

(Source: Handbook of Noise and Vibration Control)

#### What is NC curve?

This is a curve to indicate frequency-based acceptable levels, proposed and utilized for noise evaluations in the U.S.

#### How to interpret NC curve?

The band level is determined by applying octave analyses to the target noise, record the results in the NC curve to determine the maximum NC curve in each band, which shall be determined as NC value for the target noise.

### ■ PRECAUTIONS CONCERNING NOISE LEVELS

The noise values (dB) of the product indications are measured at regulated distances in anechoic chambers as specified in JIS, etc.

The following points should be considered in selecting proper products.

- (1) Changeable due to environmental conditions  
The measured values were determined in anechoic chambers. In real settings, echoes will take place from walls, floors, ceilings, etc. The measurements may also increase due to the materials used and the surrounding space. It is thus necessary to consider echo coefficients. Noise levels may also be increased by piping and placement of components.
- (2) Propagation of vibration  
Although products are designed to minimize vibration, certain levels of vibration are inevitable, as rotating mechanisms are contained. It is thus necessary to pay close attention to the installation methods appropriate to individual products.
- (3) Sound synthesis  
When multiple units are to be installed in the same room, it is necessary to consider sound syntheses. Particularly when multiple units of the same model are installed next to each other, "humming" sound may arise due to slightly different rotations.
  - Distance decay for sound  
When the sound source is sufficiently small in comparison with distance, or in the case of a point sound source, by calculating the sound level " $r_0$ " (m) at a short distance, the sound level  $L_0$ (dB) at a long distance, " $r$ " (m) is determined as " $L = L_0 - 20\log (r/r_0)$ ."
  - Sound synthesis  
The sound level may be expressed as,  $y = 10\log x$ . Thus, when  $L_1$  and  $L_2$  noises are combined, the synthesized sound level (dB) is " $L = 10\log (10^{L_1/10} + 10^{L_2/10})$ ."



## 4-4-7. NOISE CONTROL

### ■ CONTROLLING NOISE FROM EXHAUST/INTAKE OPENING

1. The following components are recommended for a ceiling-mounted unit.

- (1) Noise-reduction duct — Glass-wool duct
- Noise-reduction flexible duct

(2) Noise-reducing intake/exhaust duct

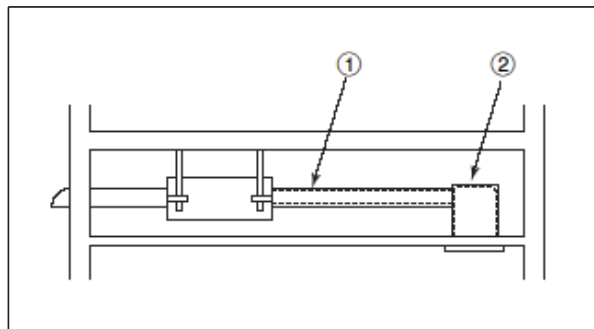

2. The following option is available for cases in which the noise reduction measures in “1” above are still insufficient, or in the case of the ceiling-suspension type.

(1) Highly efficient sound-absorption materials are used for the interior cover materials.

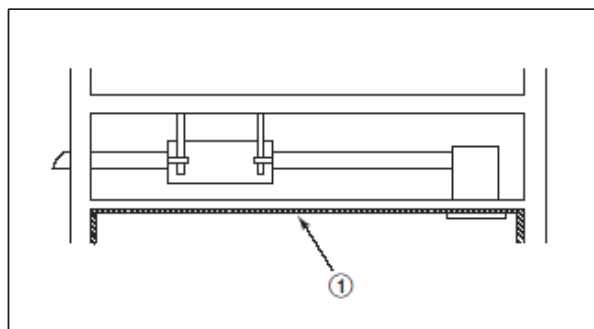

3. When the airflow sound is generated at the exhaust/intake opening in the ceiling-mounted type, the following options are available, as the sound absorption effects are higher in ducts with smaller diameters.

- (1) Branched ducts (the airflow rates at the exhaust/intake opening are reduced by dividing the flow)
- (2) One-rank lower multiple noise-reduction ducts (with smaller diameters) should be used.

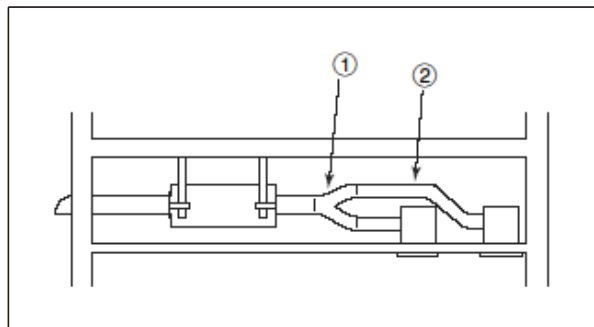

### ■ EFFECTS OF NOISE CONTROL MEASURES

#### Points

1. The noise-reduction duct (not less than 2m) should always be used at the exit of the unit on the internal supply side.
2. Spiral ducts (galvanized steel tubes) and aluminum flexible ducts should not be connected to the unit exit opening.

#### General Comparison of Effects

(1) Great Effects –  
(4) Small Effects

(1) Noise-reduction duct, installed for 6m	(2) Noise-reduction duct on the side of the unit, installed for 2m
<p>Unit</p> <p>Noise-reduction duct (6m)</p> <p>Intake/Exhaust Grill</p>	<p>Unit</p> <p>Noise-reduction duct (2m)</p> <p>Spiral Duct (4m)</p> <p>Intake/Exhaust Grill</p>
(3) Noise-reduction duct on the side of the intake/exhaust grill, installed for 2m	(4) Spiral duct, installed for 6m (no noise-reduction measure)
<p>Unit</p> <p>Spiral Duct (4m)</p> <p>Noise-reduction duct (2m)</p> <p>Intake/Exhaust Grill</p>	<p>Unit</p> <p>Spiral Duct (6m)</p> <p>Intake/Exhaust Grill</p>

	Catalog Level			(dB)
	-5	+5	+10	
①	■			
②		■		
③			■	
④				■

Note: (1) The noise levels were measured at 1.5m below the intake/exhaust grill.

(2) The noise figures are those converted to the level in an anechoic chamber. In real settings, the levels will be raised due to echoes and other effects (by about 5dB).

## ■ CONTROLLING NOISE GENERATED FROM EQUIPMENT AND AIR COURSES ABOVE CEILING AND UNDER ROOF

1. If noise control is deemed necessary as the unit is utilized in a quiet place, the following points should be carefully considered. (Otherwise, noise levels may rise.)
  - (1) Do not downgrade the duct diameters extremely.  
(E.g.,  $\varnothing 250 \rightarrow \varnothing 150$ ,  $\varnothing 200 \rightarrow \varnothing 100$ )
  - (2) Do not bend aluminum flexible ducts extremely.  
(Particularly, the bending immediately after the exit opening of the unit body)
  - (3) Do not make unnecessary openings on the ceilings.
  - (4) Do not suspend the unit under members with insufficient strength.

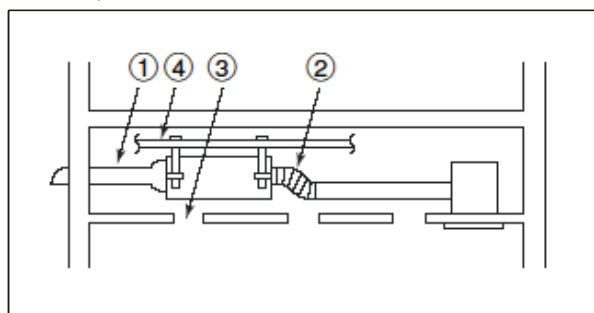

2. The following control measures may be taken.
  - (1) Ceiling materials should be of high sound insulation quality (with large transmission losses)  
<Note>  
Specifically, low-frequency noises cannot be significantly absorbed by certain ceiling materials.
  - (2) Apply additional sound-absorbing materials immediately below the sound source.
  - (3) Cover the unit body entirely with sound insulation sheets.

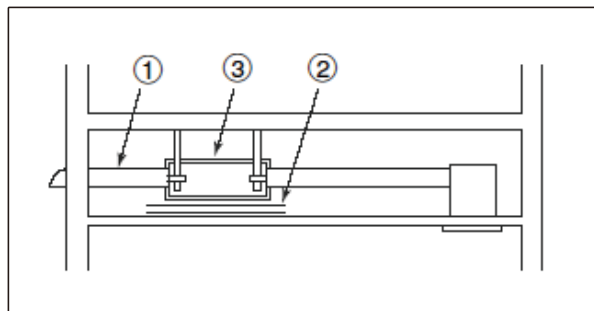

# 4-5. VENTILATION DESIGN

## 4-5-1. QUANTITY, DYNAMIC PRESSURE / STATIC PRESSURE

The performance of a ventilation fan can be expressed by “quantity” and “static pressure.” These two factors are closely related to each other and constitute prerequisites for considering “ventilation.” The first step to “ventilation design” is to understand these two factors.

### ■ QUANTITY (AIRFLOW VOLUME)

This is the airflow volume exhausted (or taken in) by a ventilating fan for a unit time, and generally expressed by m<sup>3</sup>/h or m<sup>3</sup>/min.

### ■ PRESSURE

This is the force applied by wind on a unit area, and generally expressed by Pa. The pressure can be subdivided into the following three categories.

- Dynamic Pressure  
Pressure derived from wind velocity is referred to as dynamic pressure or velocity pressure. Windowpanes of buildings bending under pressure of strong wind in storms are typical indications of dynamic pressure.
- Static Pressure  
The pressure working on inflated balloons from inside is referred to as static pressure, which functions even if air is not moving.
- Total Pressure  
The total pressure is the entire pressure of wind or air, combining both dynamic and static pressures.

### ■ RELATIONSHIPS AMONG DIFFERENT TYPES OF PRESSURE

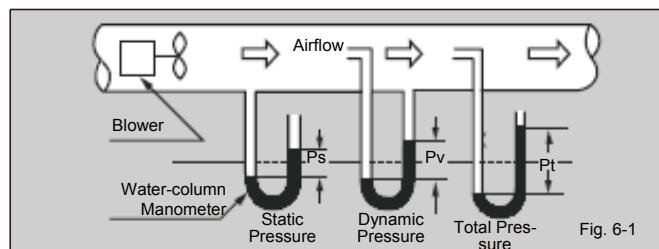

The airflow inside a duct and each type of pressure there can be illustrated as in Fig. 6-1.

Moving the certain amount of air in the duct will require “Static Pressure (Ps)” to overcome the resistance within the duct. “Dynamic Pressure (Pv)” represents the pressure applied in the direction of the airflow and can be expressed as a function of the wind velocity, can be used for measuring wind velocity.

By adding the “Static Pressure” and the “Dynamic Pressure,” “Total Pressure (Pt)” is generated. This relationship can be expressed as follows.

$$Pt = Ps + Pv = Ps + \frac{V^2}{2g} \gamma$$

- V: Flow velocity (m/sec)
- g: Gravity acceleration (m/sec<sup>2</sup>)
- γ: Specific weight of air (kg/m<sup>3</sup>)

### ■ HOW TO INTERPRET STATIC PRESSURE - QUANTITY CHARACTERISTIC CURVE (P-Q CURVE)

A graphic presentation of the relationship between the quantity and the static pressure of a ventilating fan is referred to as “P-Q Curve,” which can indicate the performance of the fan. Fig. 6-2 illustrate a case in which a small intake opening is installed on a wall, where the indoor pressure is a little lower than the atmospheric pressure (the static pressure: B [Pa] and the quantity: B' [m<sup>3</sup>/h]), and the ventilator cannot generate sufficient ventilation volume.

Fig. 6-3 illustrate a case in which a sufficiently large intake opening is installed on a wall, where the indoor pressure is almost equivalent to the atmospheric pressure (the static pressure: O [Pa] and the quantity: C' [m<sup>3</sup>/h]), and the ventilator can generate sufficient ventilation volume.

Fig. 6-4 illustrate a case in which the intake opening is large enough but the ventilating fan has a certain resistant component, such as pipe hood, etc. The quantity (D' [m<sup>3</sup>/h]) can be determined by the intersecting point made by P-Q curve and the resistance loss curve of the installed component.

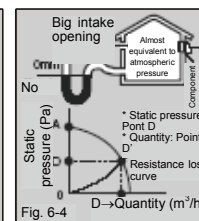
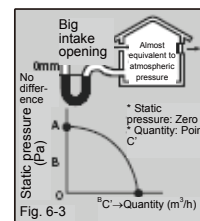
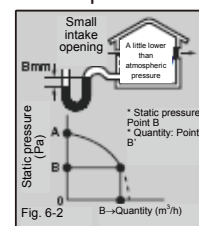

## 4-5-2. HOW TO CALCULATE REQUIRED VENTILATION VOLUME

To determine ventilation airflow volume, various calculation methods are available, based on diverse indoor conditions, such as the volume of CO<sub>2</sub> generated by the number of occupying people, the volume of exhaust gasses generated by combustion, etc.

It is necessary to specify figures as accurately as possible, based on the actual conditions in which rooms are utilized.

### ■ METHOD BASED ON THE NUMBER OF VENTILATION OPERATIONS REQUIRED FOR A ROOM

**Required Ventilation Volume (m<sup>3</sup>/h)**  
**= Number of Ventilation Operations Required in an Hour (times/h) x Cubic Capacity of Room (m<sup>3</sup>)**

- The ventilation volume can be determined by calculating the cubic capacity of the room and using the number of ventilation operations indicated in Table 6-2.

(Example) Location: Bathroom  
Required Number of Ventilation Operations:  
Five (Times/h)  
Cubic Capacity of Room: 6 Jo (about 10m<sup>2</sup>)  
Height of Room: 2.4m

From the above conditions;  
Required Ventilation Volume  
= 5 x 10 x 2.4 = 120 (m<sup>3</sup>/h)

It is thus necessary to select a ventilating fan that can satisfy the above figure.

# 4-6. DUCT DESIGN

## 4-6-1. CALCULATION OF PRESSURE LOSSES DUE TO VENTILATION THROUGH DUCT

Ventilation is always conducted through ducts in ventilation fans for ducts and oven hoods (pressure type). To determine the ventilation quantity, pressure losses due to the lengths, the number of bends, and external installation components, etc., should be accurately calculated, so that proper ventilation quantities can be determined.

### PROCEDURES FROM DUCT CALCULATION TO MODEL SELECTION

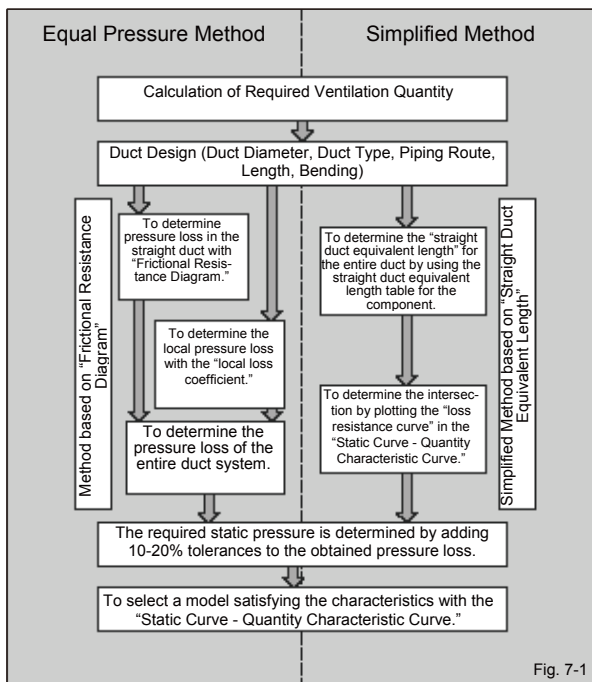

Fig. 7-1

### CALCULATION BASED ON EQUAL PRESSURE METHOD

[1] Circular Duct

(1) Duct resistance can be calculated from the following formula. To determine the pressure loss caused in air flowing through a straight duct ( $\Delta P$ ), the following formula is generally used.

$$\text{Duct Resistance } \Delta P \text{ (Pa)} = \lambda \times \frac{\gamma}{2g} \times \frac{L}{d} \times v^2 \times g$$

$\lambda$ : Friction Coefficient of Duct (0.01 - 0.25)

$g$ : Gravitational Acceleration (9.8m/sec<sup>2</sup>)

$\gamma$ : Air Density (kg/m<sup>3</sup>) 1.20kg/m<sup>3</sup>

$L$ : Duct Length (m)

$d$ : Duct Diameter (m)

$v$ : Wind Velocity in Duct (m/sec)

$$v = \frac{Q}{d^2} \times \frac{4}{3600\pi}$$

$Q$ : Quantity (Airflow) (m<sup>3</sup>/h)

Where,  $\lambda = 0.02$  (Galvanized Steel Pipe) = 9.8  $\nu = 1.2$  is substituted to produce the following.

$$\Delta P \text{ (Pa)} = 0.02 \times \frac{1.2}{2 \times 9.8} \times \frac{L}{d} \times \left( \frac{Q}{d^2} \times \frac{4}{3600\pi} \right)^2 \times 9.80665$$

### Friction coefficients of common ducts (references)

Duct Materials	$\lambda$
Aluminum flexible duct	0.03-0.04
PVC pipe	0.01-0.02
Galvanized steel pipe	0.016-0.025

(2) Method based on "Frictional Resistance Chart of Duct"

### Frictional Loss Calculation Chart for Circular Ducts (Part)

<Galvanized Steel Pipe, Internal Roughness ( $\epsilon$ ) = 0.18mm>

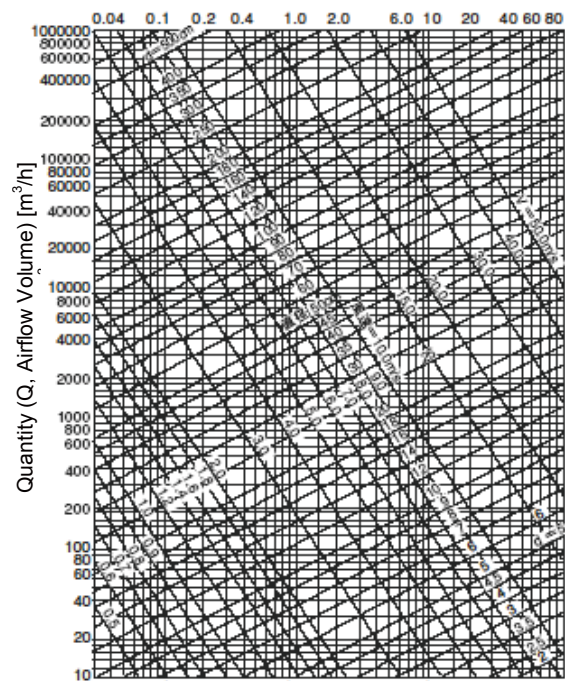

Fig. 7-2

Friction Loss Rate ( $\nu$ ) [Pa/m]  
Friction Loss Resistance Chart for Galvanized Steel Pipe

<How to Use Chart>

- (Conditions) • Ceiling-Mounted Ventilation Fan  
• Required Ventilation Quantity: 300m<sup>3</sup>/h  
• Duct Diameter:  $\phi$ 15cm  
• Duct Length: 5m

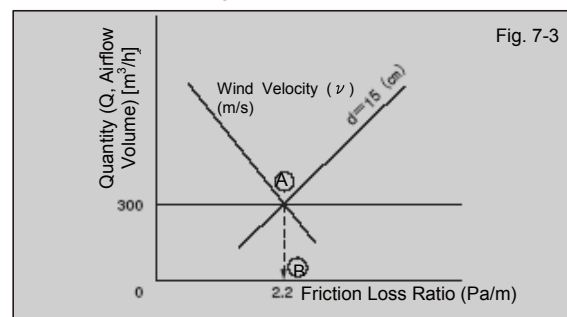

Fig. 7-3

- To determine the intersection (A) of the duct diameter ( $d$ ) (15cm) and the quantity of wind running through the duct ( $Q$ : airflow) (300m<sup>3</sup>/h).
- To determine Point (B) by dropping (A) perpendicularly.
- To determine the reading of (B) (2.2 Pa/m in this case), multiply it with the duct length (5m) to produce 11 Pa.

[2] Conversion from Rectangular Duct to Circular Duct

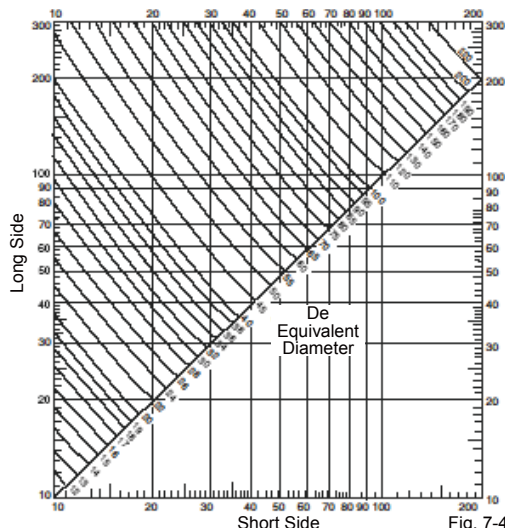
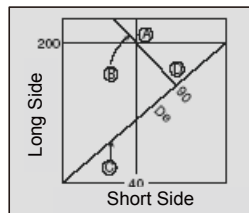

Fig. 7-4

● How to use Fig. 7-4

Example: A rectangular duct measuring 40 x 200 corresponds to a circular duct having a diameter of 90.



- To determine the intersection (A) of the short side (40) and the long side (200).
- Next, to determine the line (B) going through the intersection (A), and determine the intersection (D) with the diagonal line (C). The figure (D) indicates the corresponding diameter, which is 90 in this case.

[3] Local Pressure Loss in Duct

- Local loss coefficient (also referred to as “local resistance coefficient”)

At bends or portions where cross sections change, losses different in nature from those in straight portions will occur due to eddy currents, etc. These pressure losses in places other than straight portions can be expressed by the following formula.

$$\Delta P(\text{Pa}) = \zeta \cdot \gamma \frac{V^2}{2g} \cdot g = \zeta \cdot P_v$$

Where,  $\zeta$ : Local Loss Coefficient  
 V: Wind Velocity ..... [m/s]  
 \* This is the velocity of the upper part of the local area excluding the merging point.  
 P<sub>v</sub>: Dynamic Pressure ..... [Pa]

- Calculation of pressure loss at a local area in a duct Example: Consider a case in which the duct bends as follows.

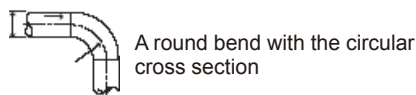

[Conditions] R/d = 1.5 V = 5.0 (m/s)  
 From Table 7-1,  $\zeta = 0.15$

$$P_v = \frac{V^2}{2g} \cdot \gamma \cdot g = \frac{5^2}{2} \times 1.2$$

$$P_v = 15 \text{ [Pa]}$$

From the above,  $\Delta P = \zeta$  (Local Loss Coefficient) x P<sub>v</sub> (Dynamic Pressure) = 0.15 x 15 = 2.25 [Pa]

The right side in Table 7-1 indicates the value of the local pressure loss in this particular part converted to a duct diameter. ( $\lambda$ : Case in which PVC pipe is used)

$$l_e = \frac{\zeta}{\lambda} d \quad <\text{Set at } 0.018>$$

l<sub>e</sub>: Straight pipe corresponding length of the local resistance ... [m]  
 d: Straight pipe diameter ... [m]  
 $\zeta$ : Local loss coefficient     $\lambda$ : Duct friction resistance coefficient

Table 7-1

No.	Name	Graphic Depiction	Conditions		Loss Coefficient $\zeta$	Length Corresponding to PVC Pipe
			H/W	R/d		
1	A round bend with the circular cross section			0.5	0.71	39d
				0.75	0.33	18d
				1.0	0.22	12d
				1.5	0.15	8d
2	A square bend with the circular cross section				1.2	67d
3	A round bend with rectangular cross section		0.5	0.5	1.30	72d
				0.75	0.52	29d
				1.0	0.25	14d
			1	1.5	0.20	11d
				0.5	1.20	67d
				0.75	0.44	24d
	1.0	0.21	12d			
	1.5	0.17	9d			

■ CALCULATION IN SIMPLIFIED METHOD

- A case in which a model is selected, based on straight pipe corresponding length and airflow quantity A model is selected, based on the following conditions.  
 Required ventilation quantity: 120 [m<sup>3</sup>/h] Duct system: Fig. 7-5 (60Hz)

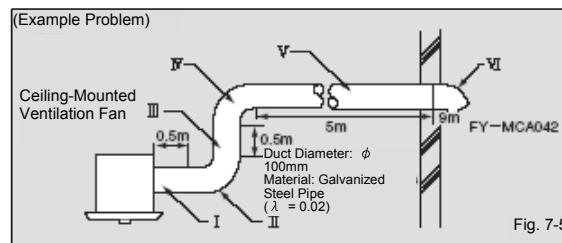

(Case in which the galvanized steel pipe of  $\lambda = 0.02$  is used)

Pipe Hood			Bent Cap		
Type	Product Number	Duct Diameter / Straight Pipe Corresponding Length	Type	Product Number	Duct Diameter / Straight Pipe Corresponding Length
Stainless Steel (Rectangular)	FY-WKX042	ø100mm / 5m	Stainless Steel (Accompanied by an insect net)	FY-VNX042	ø100mm / 5m
	FY-WKX062	ø150mm / 12m		FY-VNX062	ø150mm / 7m
Stainless Steel (Round)	FY-MCX042	ø100mm / 9m	Stainless Steel (Accompanied by a fire damper)	FY-VXA043 BL	ø100mm / 8m
	FY-MCX062	ø150mm / 13m		FY-VXA063 BL	ø150mm / 7m
Stainless Steel (Accompanied by a fire damper)	FY-MXA042	ø100mm / 12m	Aluminum	FY-VCA042	ø100mm / 2m
	FY-MXA062	ø150mm / 13m		FY-VCA062	ø150mm / 3m
Aluminum (Round)	FY-MCA042	ø100mm / 9m	(R/d = 1.0) Elbow		ø100mm / 2m
	FY-MCA062	ø150mm / 13m			ø150mm / 3m
Aluminum (Accompanied by an insect net)	FY-MNA042	ø100mm / 15m			
	FY-MNA062	ø150mm / 32m			

Table 7-2

- Table 7-2 is used to convert the resistance at each component of the duct to the straight pipe length.

Piping Portion	Length of Corresponding Straight Pipe (Diameter: 100mm)
I	0.5m
II	2m
III	0.5m
IV	2m
V	5m
VI	9m
Total	19m

Table 7-3

● Static Pressure - Quantity Characteristic Curve

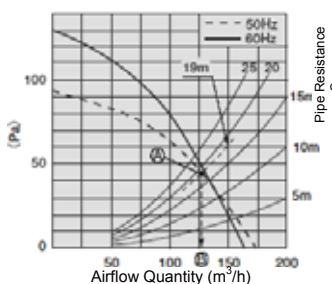

- To select an appropriate model. Case in which a model satisfying the straight pipe corresponding length: 19 [m] and the airflow quantity of 130 [m<sup>3</sup>/h] A perpendicular line is dropped from the intersection (A) made by the resistance curve of the 19 [m]-pipe and the static pressure - quantity characteristic curve to determine the point (B), and the model to be selected should satisfy the value at the point, that is, 130 [m<sup>3</sup>/h].

## MODEL INSTALLATION (FOR CEILING-MOUNTED TYPE)

### Installation of Unit Body

- You are required to prepare the ceiling suspension bolts, nuts, and washers.
- Install the unit firmly and horizontally to support its weight sufficiently. (Fig. 1)
- If you do not fit it firmly, it is not only dangerous but also easily vibrated. If it is not fitted horizontally, the damper unit becomes defective in operation.

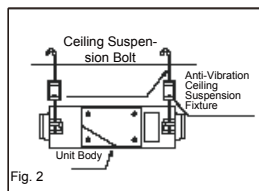
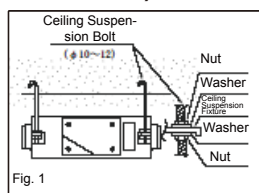

### Caution

- When you are required to be cautious particularly on prevention of vibration, we recommend you to use the anti-vibration ceiling suspension fixtures. (Fig. 2)
- Never fail to make an inspection opening with □ 450mm or more at the specified place, so that you can inspect filters, heat exchange elements, power source, and motors.

### Cautions on Installing the Unit Body Upside Down

- Re-fit the ceiling suspension fixtures in the opposite side. (If they are left as they are, the foolproof function of ceiling suspension bolts does not work and will cause the danger of dropping the unit.)
- Printed indication is in a reversed position. In particular, be careful of the arrow mark "↑" showing the direction of inserting the heat exchange element.

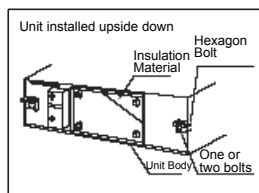

Note: The above provisions apply only to those models that allow reverse installation.

## DUCT INSTALLATION

- Wind the junction of an adaptor and a duct with an aluminum tape firmly to prevent any air leakage.
- The room intake opening should be positioned as far as possible away from the inside supply opening.
- Use the specified ducts with the diameters appropriate for the unit.
- Install two outdoor ducts, so they will be in the down gradient toward outside to prevent water from coming in. (Gradient: 1/100 - 1/50) (Fig. 3)
- Never fail to heat-insulate two indoor ducts (including intake and exhaust air ducts) to prevent dewing. (Material: Glass Wool, Thickness: 25mm) (Fig. 3)
- When you want to piece the metal duct through the metal lath or the wire lath or the metal plate of the wooden facility, do not forget to insulate electrically between the duct and the wall. (Please refer to the electric facility engineering standards and the internal regulations.)

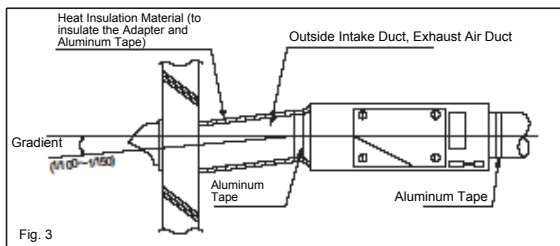

### Cautions for duct piping <When collective ducts are used>

In an installation layout as in Fig. 4, do not operate the heat exchange unit A alone.

When the heat exchange unit B stops operation, air is reversed from SA (intake opening), reducing the fresh external air, and deteriorating the ventilation efficiency.

In this case, an electric damper should be installed in the duct piping (please refer to Fig. 5), so that the opening/closing functions can be mechanically controlled.

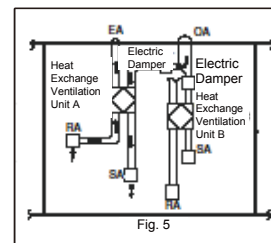
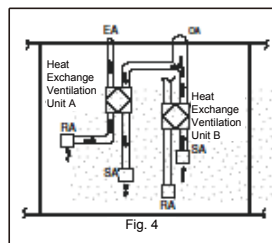

- The intake and exhaust openings on the external walls should generally be distanced from each other by about three times the duct diameter to prevent short circuits.
- Vibration prevention is basically unnecessary. (If anti-vibration ceiling suspension fixtures are required, please use FY-BG71 - BG74).
- Install the ceiling-mounted and ceiling-suspension types horizontally. (Otherwise, damper may not function properly.)
- For the ceiling-mounted type, install an inspection opening at a specified location to check the heat exchange elements, filters, and wind blower.

### ● Refrain from using the following duct installation works.

- (1) Excessive bending
- (2) Multi-times bending

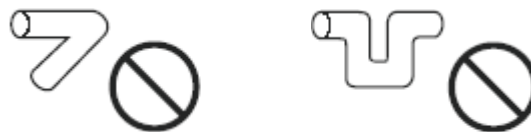

- (3) Making the connecting duct smaller

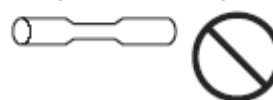

## 5. REMOTE CONTROLLER

### 5-1. FUNCTIONS

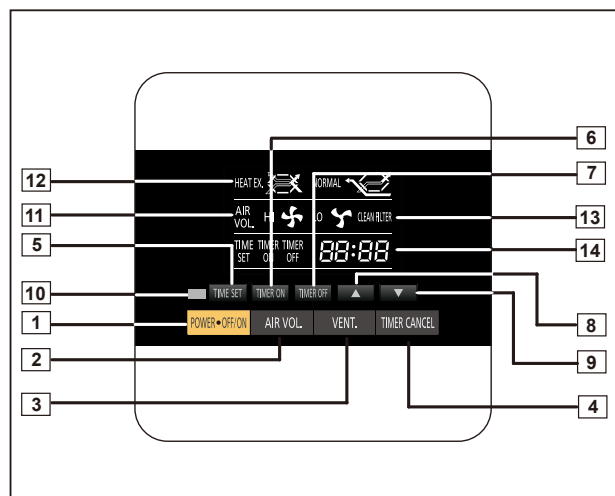

- 1 POWER OFF/ON button  
Stop / start the unit.
- 2 AIR VOL. button  
Shift air volume between high notch and low notch.
- 3 VENT. button  
Switch between heat exchange and normal ventilation.
- 4 TIMER CANCEL button  
Quit the mode of timer on and timer off, and cancel the set.
- 5 TIME SET button  
Set the hour and minute.
- 6 TIMER ON button  
Set the hour and minute of timer on.
- 7 TIMER OFF button  
Set the hour and minute of timer off.
- 8 ▲  
Increase the hour / minute in mode of time set, timer on / off.
- 9 ▼  
Decline the hour / minute in mode of time set, timer on / off.
- 10 Operate/standby display  
Unit operates, stops or in standby mode.
- 11 Air volume display  
Unit operates in the high / low air volume.
- 12 Ventilation display  
Unit operates in the heat exchange mode or normal ventilation mode.
- 13 Clean filter display  
It shows filter is required to clean. After cleaning, simultaneously press the "▲" and "▼" for 3 seconds, the signal light for "clean filter" is dark.
- 14 Display of time set, timer and filter usage  
It displays the current time, operation mode of non-timer or timer on / off and accumulated time of filter usage.

### 5-2. SYSTEM DIAGRAM

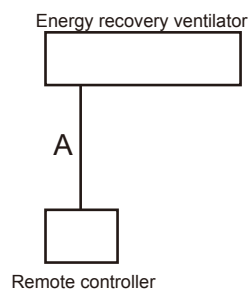

A : Remote controller cable.  
A ≤ 500 m



### 5-3. ELECTRICAL WIRING

#### ● Single control

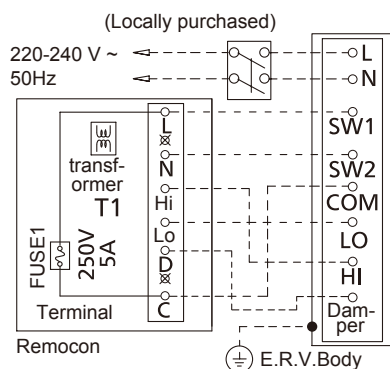

### 5-4. DIMENSIONS

[Unit : mm]

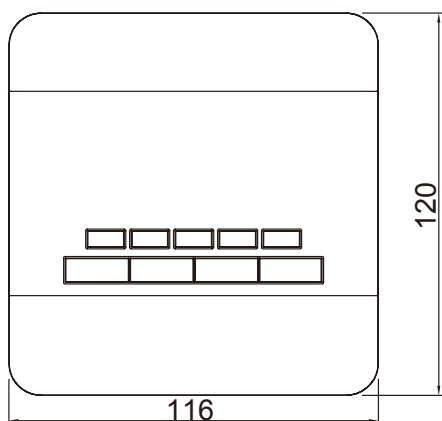

Front View

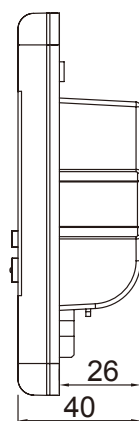

Side View

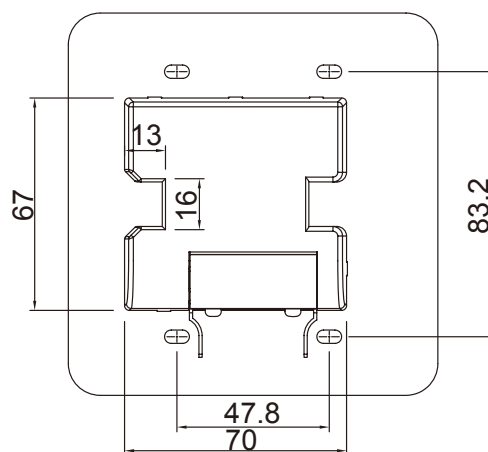

Rear View

### 5-5. SPECIFICATIONS

Dimensions [H × W × D] (mm)	120 × 116 × 40
Weight (g)	300

### 5-6. WIRING SPECIFICATIONS

Cable type	Size	Remarks
Remote controller cable	1.5 mm <sup>2</sup> (15 AWG)	Use shielded cable (locally purchased) in accordance with the regional cable standard.