

Energy Recovery Ventilators Installation Manual

ENGLISH

Ventilateurs d'échange de
chaleur
Manuel d'installation

FRANÇAIS

Lüftungsgerät
mit Wärmerückgewinnung
Installationshandbuch

DEUTSCH

Ventilatori a scambio
termico
Manuale di installazione

ITALIANO

Ventiladores de intercambio
calorífico
Manual de instalación

ESPAÑOL

Ventiladores de permutação
de calor
Manual de instalação

PORTUGUÊS

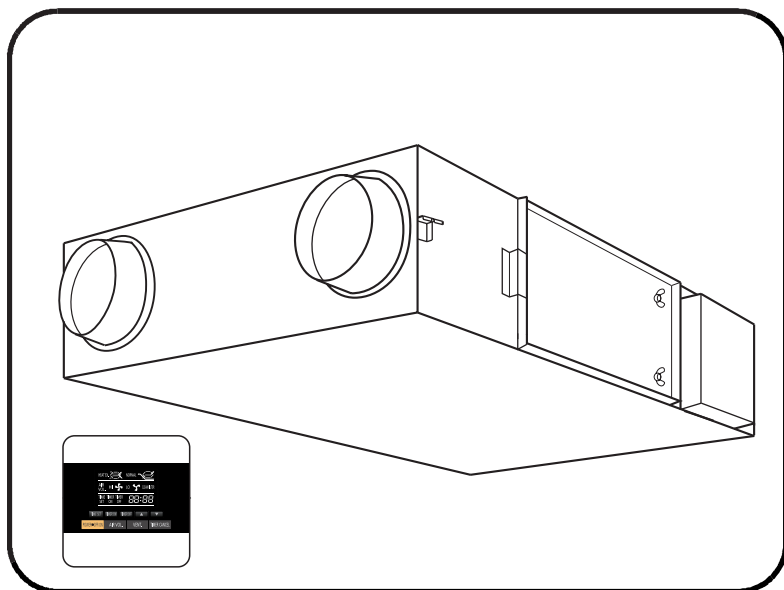

Model No.
N° de modèle
Modell-Nr.
Modello N.
Modelo N.º
N° do modelo

UTZ-BD025C

UTZ-BD035C

UTZ-BD050C

UTZ-BD080C

UTZ-BD100C

- Read through this “Cautions on Safety” with care before installing the unit.
- Described below are the way we are stimulating your attention to what you are supposed to observe to prevent dangers to the users or other people as well as loss to the property.



Cautions on Safety



Never Fail to Observe

- If the supply cord is damaged, it must be replaced by the manufacturer, its service agent or similarly qualified persons in order to avoid a hazard.
- This appliance can be used by children aged from 8 years and above and persons with reduced physical, sensory or mental capabilities or lack of experience and knowledge if they have been given supervision or instruction concerning use of the appliance in a safe way and understand the hazards involves.
- Children shall not play with the appliance. Cleaning and user maintenance shall not be made by children without supervision.
- Make sure to disconnect the power plug before cleaning the product.





Never fail to observe the caution items described hereinafter because all of them refer to the critical matters on safety. The meanings of the marks or indications are described below.

- The degrees of danger or damage that is likely to occur due to the wrong use ignoring the indications are categorized for explanation as marked below.
- Kinds of the items to be observed are categorized for clarification with the following pictorial symbols.



	WARNING	The column with this mark shows “Conceivable Threat of Death or Serious Injury”.
	CAUTION	The column with this mark shows “Likelihood of Damage or Loss to Materials only”.

	This pictorial indication shows “Prohibited”.
	This pictorial indication shows “Forced Execution”.

WARNING

	Never fail to ask the sales office from which you bought the unit or the installation service shop to install the unit. If you install it by yourself, any inappropriate installation works would cause an electric shock or a fire.		The external air intake opening should be positioned away from the exhaust openings of combustion gases etc. The intake of such gases could cause a lack of oxygen in the room. The external air intake opening should not be positioned where discharged air may directly enter it. A situation like this will lead to the room being contaminated and this may pose a health risk.
	Carry out the installation works accurately in line with this installation work manual. Improper practice of installation could cause an electric shocks or a fire.		Netting or something similar should be provided at the external air intake opening to prevent birds etc. interfering with the unit. Nests or other foreign objects should be removed. That could cause a lack of oxygen in the room.
	Choose the installation place where is endurable in quality as well as in weight, then install the unit accurately with adequate strength and completeness of installation in accordance with the installation work manual. Otherwise, it is likely to cause an electric shock, a fire, a drop of the unit, thus causing the injury on the human body.		Carry out the ground work. Never connect the ground wire to a gas pipe, a water supply pipe, a lightning conductor, a ground line of a telephone, etc. An incomplete ground wire is likely to cause an electric shock.
	Carry out electrical work in accordance with the laws and regulations prevailing in the country concerned, technical standard and explanation for work, and make absolutely sure that an exclusive circuit is used. Any insufficient capacity of power circuit and improper work can result in electric shock and fire hazard.		When the system is checked and the power cable undergoes maintenance, stop the operation, and switch the exclusive circuit breaker "OFF". Otherwise, it could cause an electric shock.

 CAUTION

	<p>Provide an exclusive circuit breaker that can completely break contacts on all the poles by more than 3mm through direct connection to the power terminals. Depending upon the environment for installation, it becomes necessary to install an earth leakage breaker.</p>		<p>Install the power line and the connecting line with accuracy so the power source cover may not float. If the installation of the power source cover is inappropriate, the pin connection area is likely to cause a heat generation, a fire and an electric shock due to dust or powder.</p>
	<p>When you want to pierce the metal duct through the metal lath or the wire lath or the metal plate of the wooden facility, do not forget to insulate electrically between the duct and the wall. Otherwise, it would cause an electric shock or an electric leakage.</p>		<p>Never install the unit near the place where there is a fear of leakage of an inflammable gas. If gas happens to leak and stays around the unit, it is likely to cause a fire.</p>
	<p>Don't use other parts than specified (including the auxiliary parts) for installation works. If you do not use the specified parts, it is likely to cause a drop of the unit, a fire, an electric shock, etc.</p>		<p>Don't use the unit at the other voltages than the rated one. It could cause a fire or an electric shock.</p>
	<p>Install the outdoor duct in a falling gradient toward the outside so as to prevent water from coming in. If it is not installed so, the building is likely to be flooded, wetting the household effects.</p>		<p>Do not install the unit in locations with large amounts of oily smoke, such as food preparation areas. It could cause a fire.</p>
	<p>Heat-insulate the outdoor duct (including the indoor side, if necessary) to prevent dewing. If heat insulation is not adequate, water likely goes indoor and wets the household properties.</p>		<p>Don't install the unit at the place of a high temperature or a flame. It could cause a heat generation or a fire.</p>
	<p>When it is high humid and high temperature inside the ceiling, a ventilation system must be installed inside the ceiling. Otherwise, it could cause a fire or an electric leakage.</p>		<p>Do not install in locations where harmful or corrosive gasses may be present (i.e. acidic, alkali, organic solvent, paint gasses etc. from machinery or factories). Installation in such a location could cause a gas-poisoning and a fire.</p>
	<p>Connect the power line and the connecting line with accuracy using the specified cables and fix them firmly so as not to put the outer stress of the cables on the pin connecting area. Incomplete connection or fixing is likely to cause a heat generation or a fire.</p>		<p>Do not install in locations with high humidity, such as close to bathroom etc. It could cause an electric shock or an electric leakage etc.</p>

Cautions for Operation

Never fail to make the inspection opening at the specific place on the ceiling so you can perform the constant cleaning or the equipment checking of filter and heat exchange element.

- The inspection opening shown below is necessary to clean the heat exchange element and the filter as required. If not cleaned, they are likely to get clogged, resulting in degradation of performance.

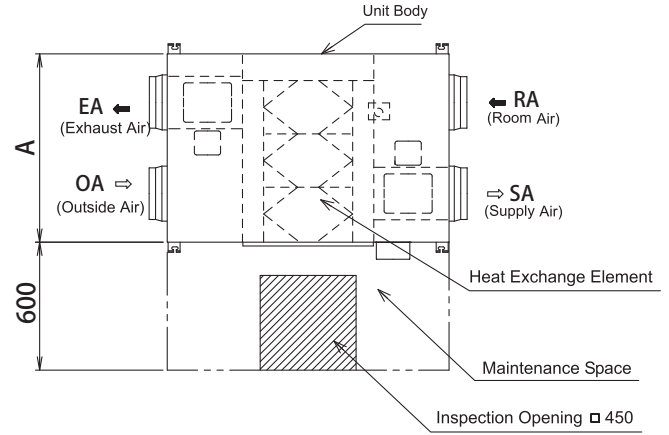
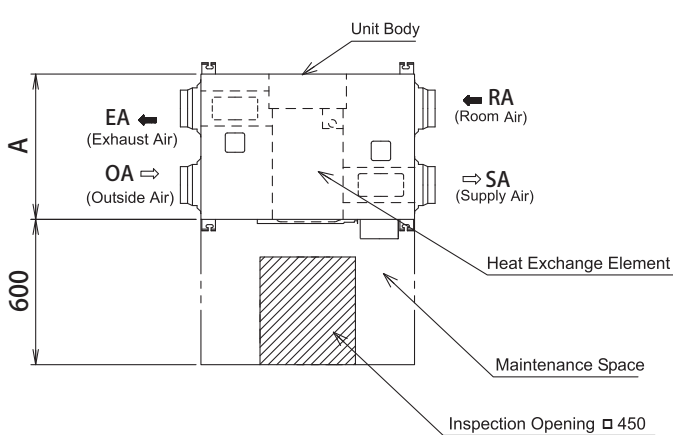

Note) Model UTZ-BD035C and UTZ-BD050C have two Heat Exchange Elements.

Unit: mm

Model No.	A
UTZ-BD025C	599
UTZ-BD035C	804
UTZ-BD050C	904

Note) Model UTZ-BD100C has four Heat Exchange Elements.

Unit: mm

Model No.	A
UTZ-BD080C	884
UTZ-BD100C	1134

- This Energy Recovery Ventilators should be installed at the place where a larger space than the sizes shown below can be secured for the ceiling space.

Unit: mm

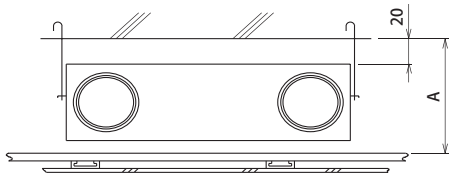

Model No.	Ceiling Space A	Model No.	Ceiling Space A
UTZ-BD025C	320	UTZ-BD080C	440
UTZ-BD035C	370	UTZ-BD100C	
UTZ-BD050C			

- Don't install it near the water-heater.
- Refrain from the following duct installation works.

(1) Excessive bending



(2) Multi-times bending



(3) Making the connecting duct smaller

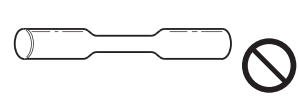

- Do not use in bathrooms or food preparation areas etc. If you use the unit at the place of much soot and high humidity, the filter or the heat exchange element gets clogged and disables you to use it.

- Use the Energy Recovery Ventilators in the ambient temperature of 40°C or less. Never install the unit at the place where the flame likely reaches directly the unit. If you use it at the atmosphere of more than 40°C for hours, it is likely to cause deterioration or deformation or damage of the resin part.

- Be careful of dewing and frosting. As shown in the figure to the right, suppose a high temp absorbing air condition A and a low temp absorbing air condition B are plotted on the air line figure, then a high temp air A is heat-exchanged by the unit and goes out of the saturation curve as shown by Point C. In this case, the unit will be dewed or frosted. To avoid this, you are required to heat a low temp air B up to B' so as to get C' below the saturation curve, before using the unit.

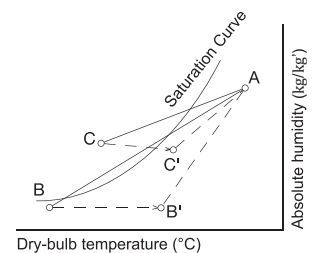

Cautions for Installation



- Install at a stable place of sufficient strength.



Please note that there might be some places not strong enough to install due the structure of building.

- Do not install in locations where harmful or corrosive gasses may be present (i.e. acidic, alkali, organic solvent, paint gasses etc. from machinery or factories)

Installation in such a location could cause a gas-poisoning and a fire.



Prohibited

- Never fail to install the unit inside the heat insulating walls or, in other words, in the space insulated from the open air.

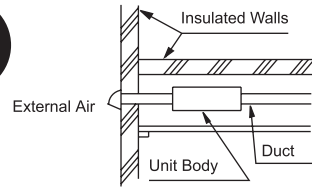

Local Procurements

- Cable for supply cord : VVF cable with $\Phi 1.6$ or $\Phi 2$.

Cable for connecting main unit and remote controller : 300V/500V , 60227IEC10 (hard wire). Cross-section area for each core wire is 1.5mm².

Reference Sketch

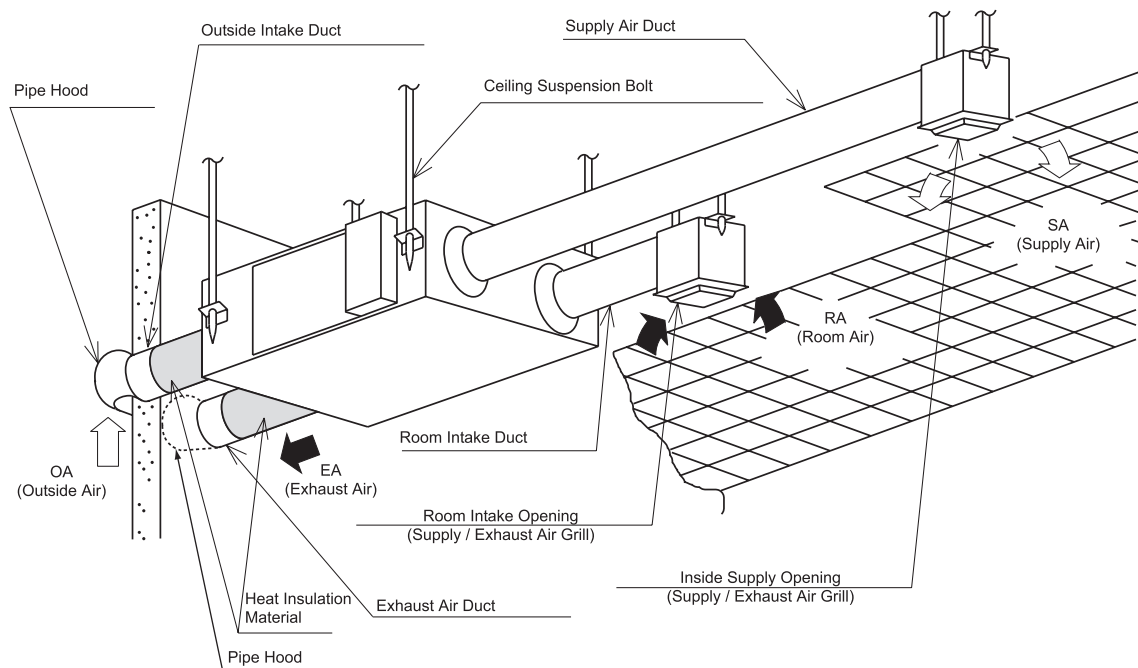

Use conditions

Outdoor air conditions: Temperature range -10°C ~ 40°C , relative humidity 85% or less

Indoor air conditions: Temperature range -10°C ~ 40°C , relative humidity 85% or less

Installation requirements: Same as the indoor air conditions

* Indoor air here means air in air-conditioned living rooms. Its use in refrigerators or other places where temperature can fluctuate greatly is prohibited even if a temperature range is acceptable.

Example: Indoor air conditions

During cooling period: Temperature 27°C , relative humidity 50%

During heating period: Temperature 20°C , relative humidity 40%

Name and Dimension of Each Part

Model No. UTZ-BD025C
 UTZ-BD035C
 UTZ-BD050C

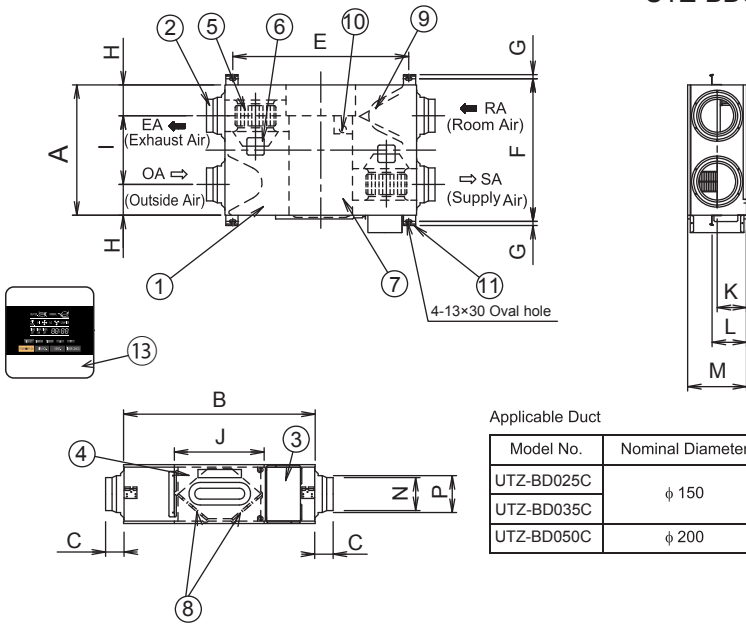

Applicable Duct

Model No.	Nominal Diameter
UTZ-BD025C	φ 150
UTZ-BD035C	φ 150
UTZ-BD050C	φ 200

Number	Name	Quantity	Note
1	Frame	1	
2	Adapter	4	
3	Terminal	1	
4	Inspection Cover	1	
5	Fan	2	
6	Motor	2	Note2)
7	Heat Exchange element	1	Note1)
8	Filter	2	
9	Damper	1	
10	Damper Motor	1	
11	Ceiling Suspension Fixture	4	
12	Electrical Equipment Box	1	
13	Energy Recovery Ventilator Remocon	1	

Note1) Model No.UTZ-BD035C and UTZ-BD050C have two Heat Exchange Elements.
 Note2) Model No.UTZ-BD035C and UTZ-BD050C have different fan and motor locations.

Unit: mm

Model No.	A	B	C	E	F	G	H	I	J	K	L	M	N	P
UTZ-BD025C	599	882	95	810	655	19	142	315	414	135	159	270	φ 144	φ 164
UTZ-BD035C	804	1050	70	978	860	19	112	580	470	159	182	317	φ 144	φ 164
UTZ-BD050C	904	1090	70	1018	960	19	132	640	470	159	182	317	φ 194	φ 210

Model No. UTZ-BD080C
 UTZ-BD100C

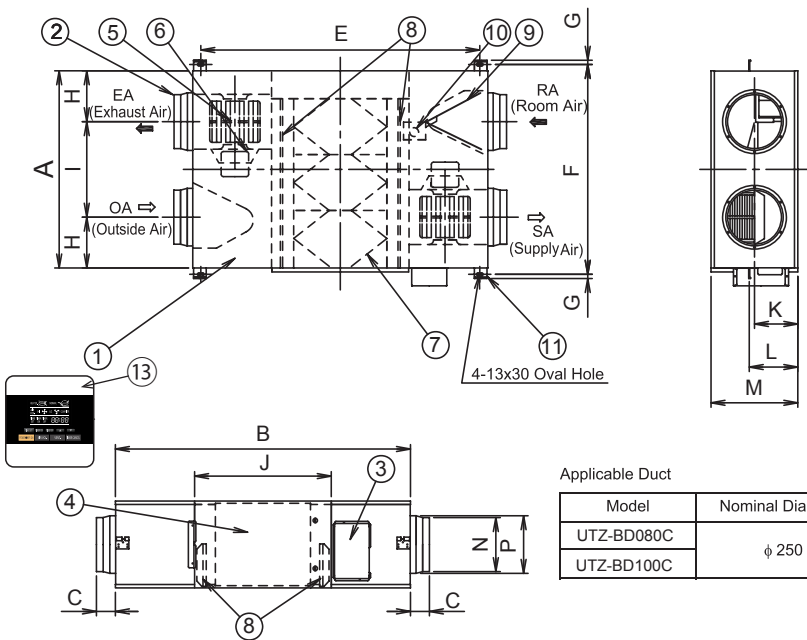

Applicable Duct

Model	Nominal Diameter
UTZ-BD080C	φ 250
UTZ-BD100C	

Number	Name	Quantity	Note
1	Frame	1	
2	Adapter	4	
3	Terminal	1	
4	Inspection Cover	1	
5	Fan	2	
6	Motor	2	
7	Heat Exchange element	3	Note1)
8	Filter	2	
9	Damper	1	
10	Damper Motor	1	
11	Ceiling Suspension Fixture	4	
12	Electrical Equipment Box	1	
13	Energy Recovery Ventilator Remocon	1	

Note1) Model No.UTZ-BD100C has four Heat Exchange Elements.

Unit: mm

Model No.	A	B	C	E	F	G	H	I	J	K	L	M	N	P
UTZ-BD080C	884	1322	85	1250	940	19	228	428	612	194	218	388	φ 242	φ 258
UTZ-BD100C	1134	1322	85	1250	1190	19	228	678	612	194	218	388	φ 242	φ 258

Installation Method

1. Model Installation

- You are required to prepare the ceiling suspension bolts, nuts and washers.
- Install the unit firmly and horizontally enough to support its weight. (Fig. 1)
- If you do not fit it firmly, it is not only dangerous but also easily vibrated. If it is not fitted horizontally, the damper unit becomes defective in operation.

Caution

- When you are required to be cautious on prevention of vibration, we recommend you to use the anti-vibration ceiling suspension fixtures.
- Never fail to make an inspection opening with \square 450 mm or more at the place shown on the paragraph of "Cautions For Operation", so that you can inspect filters, Heat Exchange Elements, power source and motors.

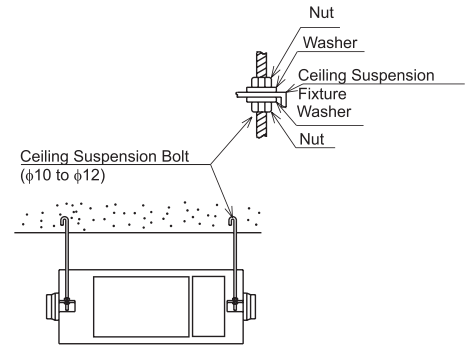

Fig. 1

2. Cautions on Installing The Unit Body Upside Down

- Re-fit the ceiling suspension fixture in an opposite side. (If they are left as it is, the foolproof function of ceiling suspension bolts do not work and will cause the danger of dropping of the unit.)
- Printed indication is in a reversed position.

In particular, be careful of the arrow mark [↑] showing the direction of inserting a Heat Exchange Element.

Electric Works

Ask a specialized electrical construction operator for advice regarding wiring in accordance with "Technical Standards for Electrical Equipment" and "Interior Wiring Regulation".

- Connect wires/cables indicated by broken lines.

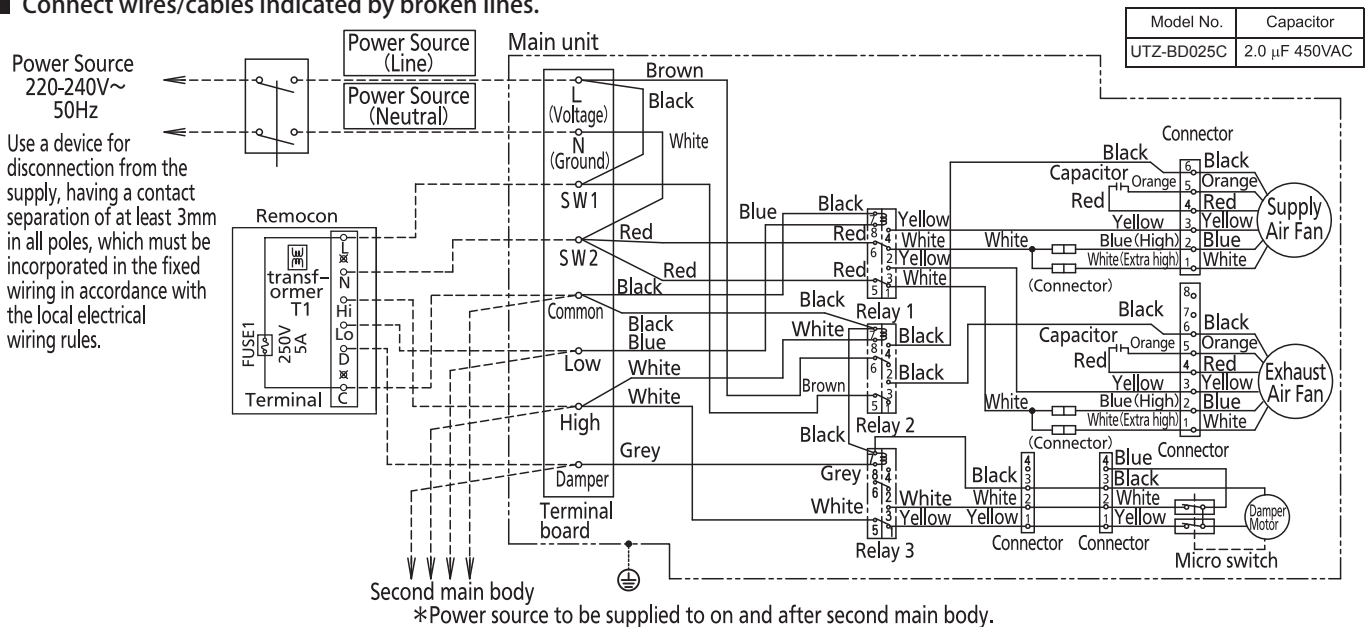

- For power supply, use a VVF cable with ϕ 1.6 or ϕ 2.
- Take the following steps on connect wires/cables:
 - Remove two screws fixing the cover of the electrical components box, open the cover, and connect wires/cables correctly.
 - Secure the cable drawn from the terminal board firmly with the cable holder.
- If a large volume of air is required or a long duct is used, switch the wire connection from Low to Extra high according to the following steps:
 - Remove two screws securing the cover of the electrical components box, and open the cover.
 - In the electrical components box, change the connection of fan motor leads from High to Extra high.

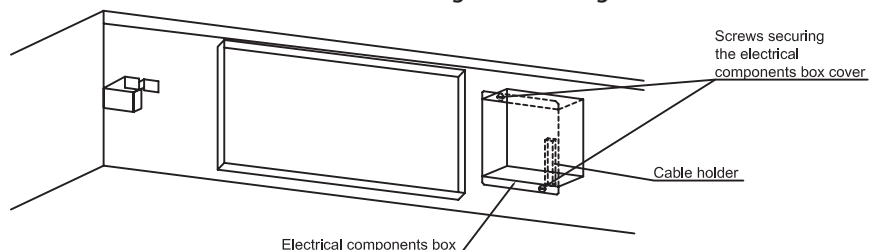
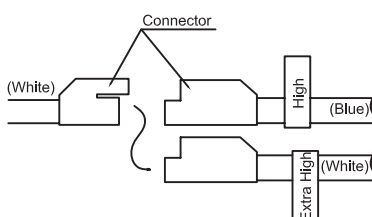

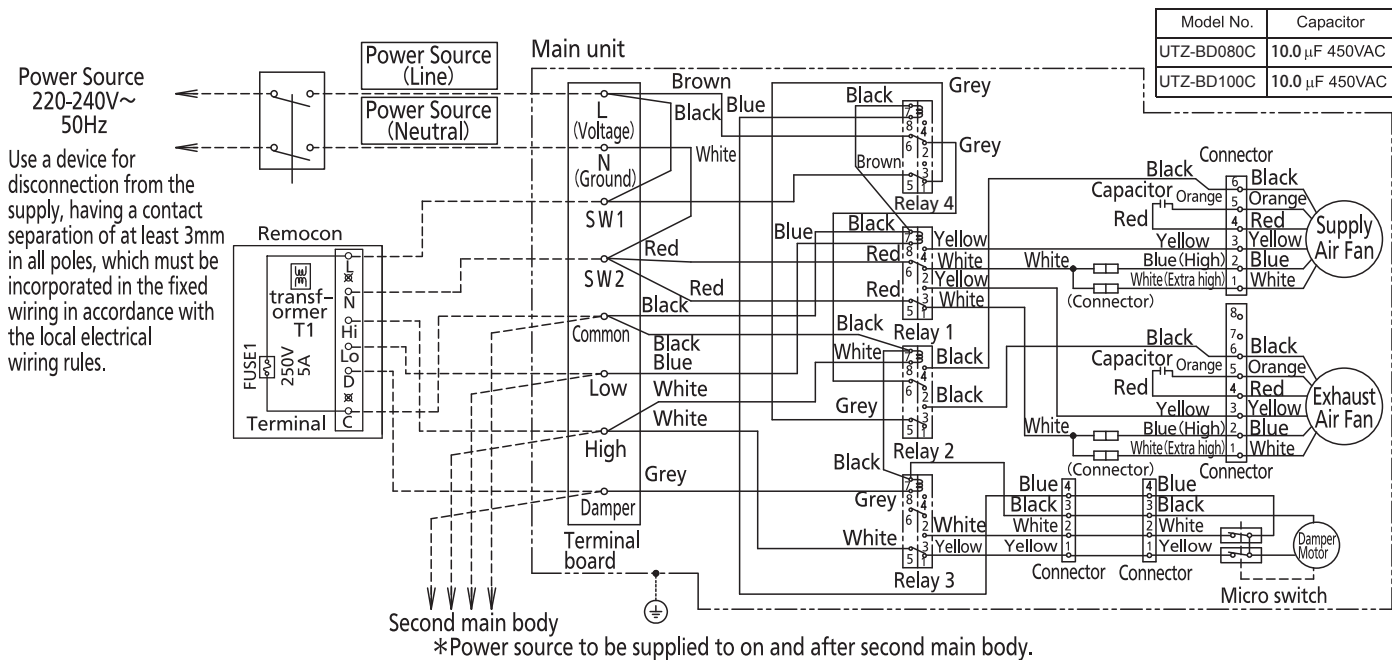
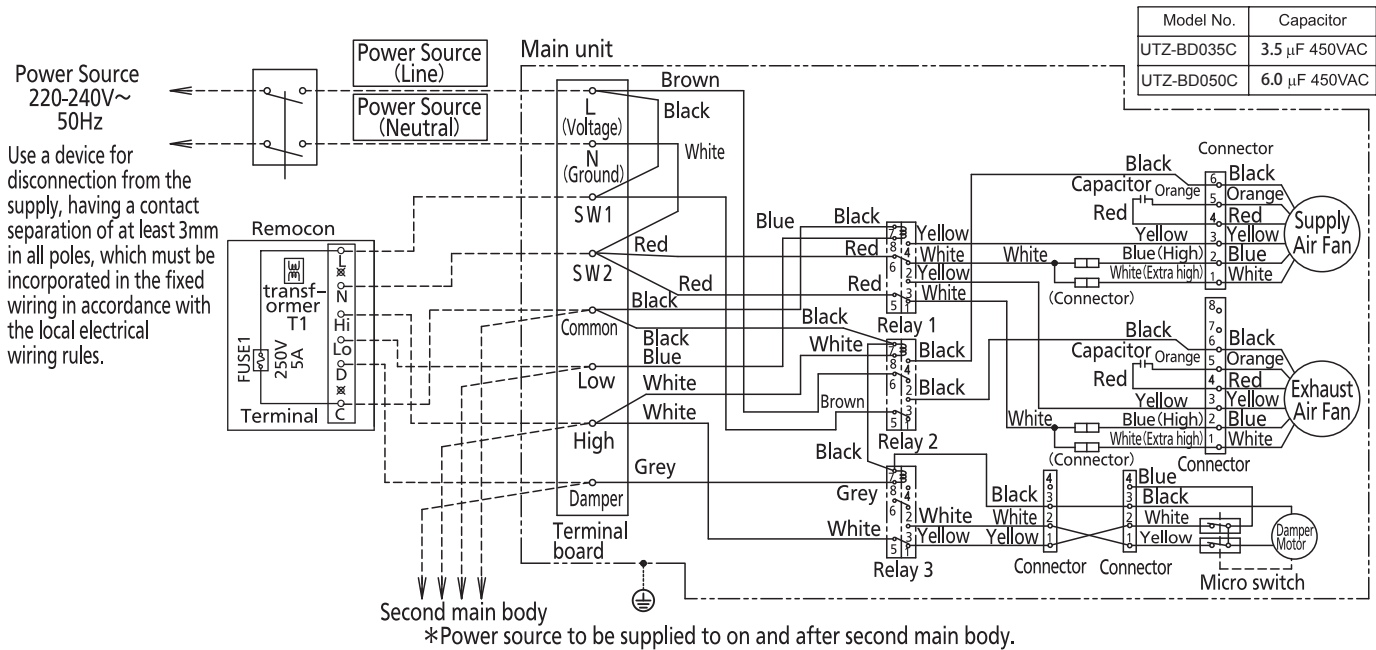

Caution

- When operating multiple air-to-air heat exchange units using a single switch ,the maximum number of units able to be operated is 10.
- Be sure to use the appropriate power supply corresponding to each model number,Using an inappropriate power supply may cause the motor to burn out.
- Grounding work must be based on Class D as defined in "Technical Standards for Electrical Equipment".
- After wire connections are completed ,check the connection again before turning the power on.

Duct Installation

- Duct installation is necessary to protect against access to live parts, rain water or contact with moving parts.
- Seal the junction of an adaptor and a duct with an aluminum tape firmly to prevent any air leakage.
- The room intake opening should be positioned as far as possible from the inside supply opening.
- Use the specified ducts. (See the Name and Dimension of Each Part.)
- Install two outdoor ducts so they will be in the down gradient toward outside to prevent water from coming in. (Gradient: 1/100~1/50) (Fig. 2)
- Never fail to heat-insulate two outdoor ducts (including outside air and exhaust air duct) to prevent dewing. (Material: Glass Wool, Thickness-25mm) (Fig. 2)
- When you want to pierce the metal duct through the metal lath or the wire lath or the metal plate of the wooden facility, do not forget to insulate electrically between the duct and the wall. (Refer to the laws and regulations of the country concerned and the technical standard.)

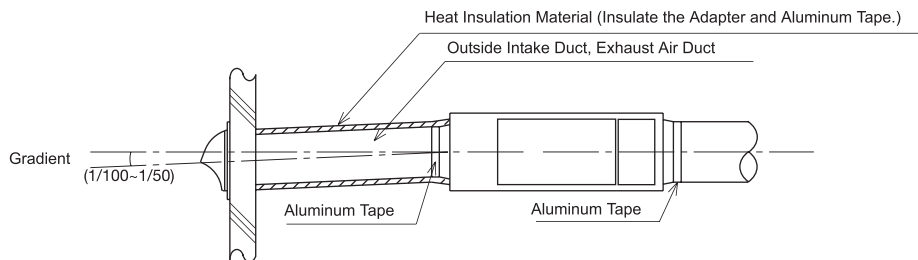

Fig. 2

Pilot Running

- On completion of installation works, never fail to check wirings and perform a pilot running.
- After completion of wiring, power ON and perform a pilot run according to the following steps for checking a airflow condition and a damper operation.
- Check the opening and closing of a damper by opening the inspection cover of the side of the unit.
 - Model No. UTZ-BD080C,UTZ-BD100C, two Fan Motors are stopped during an operation of the damper.

	Each switch setting		Checking items	
	Function Select Switch	Air Flow Switch	Airflow condition	Damper
1	Energy Recovery	High (Extra High)	Check if the air from inside supply opening and the one from room intake opening are set to High (Extra High) and to Low, respectively	Open (A Damper is beyond)
		Low		
2	Normal Ventilation	High (Extra High)		
		Low		Close (A Damper is near)

- In case that any abnormality occurs in a pilot running, its conceivable cause would be a wrong wiring. Don't forget to switch the exclusive breaker to OFF before correcting the wiring. Otherwise, it is likely to cause an electric shock.

FUJITSU GENERAL LIMITED

Printed in China
Gedruckt in China
Imprimé en Chine
Impreso en China
Stampato in Cina
Impresso na China

25ZDY8RFG0854 P0917-0

Pursuant to at the directive 2014/30/EU,article 9(2)