

Energy Recovery Ventilators

Owner's Manual

ENGLISH

**Ventilateurs d'échange de
chaleur**
Manuel l'utilisateur

FRANÇAIS

**Lüftungsgerät mit
Wärmerückgewinnung**
Bedienungsanleitung

DEUTSCH

**Ventilatori a scambio
termico**
Manuale d'istruzione

ITALIANO

**Ventiladores de intercambio
calorífico**
Manual de propietario

ESPAÑOL

**Ventiladores de permutação de
calor**
Manual proprietário

PORTUGUÊS

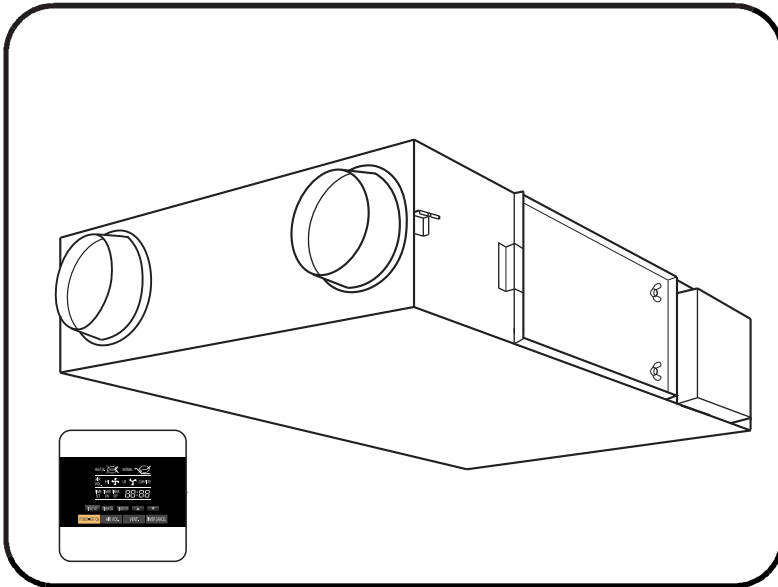

Model No.
N° de modèle
Modell-Nr.
Modello N.
Modelo N.º
N° do modelo

UTZ-BD025C

UTZ-BD035C

UTZ-BD050C

UTZ-BD080C

UTZ-BD100C

Installation manual is attached separately
Le manuel d'installation est joint séparément.
Installationsanleitung ist gesondert beigelegt
Il manuale di installazione è allegato separatamente.
El Manual de instalación se adjunta por separado.
O manual de instalação é fornecido em separado.

Thank you very much for having purchased our “Energy Recovery Ventilator”. We hope you read through this owner’s manual with care so that you can use the unit correctly. After reading it, please keep it so you can read it whenever necessary.

CONTENTS



Cautions on Safety	2-3
Features	4
Name of Each Part	5
Specific Caution Items	6
Model Installation	7
After-sales Service	8
Specifications	9–10

Cautions on Safety Never Fail to Observe



- If the supply cord is damaged, it must be replaced by the manufacturer, its service agent or similarly qualified persons in order to avoid a hazard.
- This appliance can be used by children aged from 8 years and above and persons with reduced physical, sensory or mental capabilities or lack of experience and knowledge if they have been given supervision or instruction concerning use of the appliance in a safe way and understand the hazards involves.
- Children shall not play with the appliance. Cleaning and user maintenance shall not be made by children without supervision.
- Make sure to disconnect the power plug before cleaning the product.

Described below are the way we are gaining your attention to what you are supposed to observe to prevent dangers to the users or other people as well as loss to the property.







- The degrees of danger or damage that is likely to occur due to the wrong use ignoring the indications are categorized for explanation as marked below.

	DANGEROUS	The column with this mark shows "Impending Danger of Death or Serious Injury".
	WARNING	The column with this mark shows "Conceivable Threat of Death or Serious Injury".
	CAUTION	The column with this mark shows "Likelihood of Damage or Loss to Materials only".

- Kinds of the items to be observed are categorized for clarification with the following pictorial symbols. (The marks described below are samples.)

	This pictorial indication shows "Prohibited".
	This pictorial indication shows "Forced Execution".













Cautions for Operation

<div style="text-align: center;"> DANGEROUS</div> <ul style="list-style-type: none"> ■ Do not use as an air circulators for open-type burners (heaters). <div style="display: flex; align-items: center;"> <div style="text-align: center; margin-right: 20px;">  Prohibited </div>  </div> <p>When gas or oil stoves are used in the home, separate equipment for circulating the air should be used.</p>	<div style="text-align: center;"> WARNING</div> <ul style="list-style-type: none"> ■ Don't push a finger or a stick into the air inlet or the outlet. <ul style="list-style-type: none"> ● A fan with a high rpm will injure you. ■ Modification of the system is strictly prohibited. <ul style="list-style-type: none"> ● Improper practice of repair could cause a water leakage, an electric shock or a fire. ● When the system needs a repair, consult your dealer.
<ul style="list-style-type: none"> ■ When any abnormal condition (scorching smell or others) is found, stop the operation immediately and switch the exclusive circuit breaker "OFF". <div style="display: flex; align-items: center;"> <div style="text-align: center; margin-right: 20px;">  </div>  </div> <p>If you continue the operation without removing the cause, it could cause an electric shock or a fire.</p> <ul style="list-style-type: none"> ● When the system needs a repair, consult your dealer. 	<ul style="list-style-type: none"> ■ If there is a combustible gas leakage from other appliances, ventilate the room by opening windows. <ul style="list-style-type: none"> ● If operation were to be attempted in such a situation, sparking at electrical contact points could cause an explosion. ■ Netting or something similar should be provided at the external air intake opening to prevent birds etc. interfering with the unit. <ul style="list-style-type: none"> ● Nests or other foreign objects should be removed. That could lead to a lack of oxygen in the room. ■ If the supply cord is damaged, it must be replaced by the manufacturer or its service agent or a similarly qualified person in order to avoid a hazard.

Cautions on Safety Never Fail to Observe



Cautions for Operation

CAUTION

<p>■ It is strictly prohibited to place a container of combustible gas or liquid near Energy Recovery Ventilators or to spray it directly with the gas or liquid.</p> <p style="text-align: center;">It could cause a fire.</p> <div style="text-align: center;">  <p>Prohibited</p> </div>	<p>■ Combustion apparatus should not be placed allowing a direct exposure to wind of Energy Recovery Ventilators.</p> <p style="text-align: center;">Incomplete combustion could occur on the apparatus.</p> <div style="text-align: center;">  <p>Prohibited</p> </div>	<p>■ Do not wash Energy Recovery Ventilators with water.</p> <p style="text-align: center;">It could cause an electric shock.</p> <div style="text-align: center;">  <p>Keep from water</p> </div>
<p>■ Do not use outside the rated voltage.</p> <p style="text-align: center;">It could cause a fire or an electric shock.</p> <div style="text-align: center;">  <p>Prohibited</p> </div>	<p>■ Don't blow directly towards animals or plants.</p> <p style="text-align: center;">Likely to cause bad effect on animals and plants.</p> <div style="text-align: center;">  <p>Prohibited</p>  </div>	<p>■ Do not handle switches with a wet hand.</p> <p style="text-align: center;">It could cause an electric shock.</p> <div style="text-align: center;">  <p>Don't touch with wet hands</p> </div>
<p>■ This appliance can be used by children aged from 8 years and above and persons with reduced physical, sensory or mental capabilities or lack of experience and knowledge if they have been given supervision or instruction concerning use of the appliance in a safe way and understand the hazards involved.</p> <div style="text-align: center;">  </div>	<p>■ Don't put a container of water on Energy Recovery Ventilators.</p> <p style="text-align: center;">When water spills, it is likely to enter inside the unit and degrade electric insulation, possibly resulting in an electric shock.</p> <div style="text-align: center;">  <p>Prohibited</p> </div>	<p>■ If Energy Recovery Ventilators are not used for a long period of time, switch the exclusive circuit breaker "OFF" for safety reasons.</p> <div style="text-align: center;">   </div> <p style="text-align: center;">If the power is left on, any build-up of dust could cause a heat generation or a fire.</p>
<p>■ Children shall not play with the appliance. Cleaning and user maintenance shall not be made by children without supervision.</p> <div style="text-align: center;">  </div>		

Cautions for Installation

CAUTION

<p>■ The system should never be used for any other purposes than intended such as for preservation of foods, flora and fauna, precision devices or work of art.</p> <div style="text-align: center;">   </div> <p>● It could cause deterioration of foods or other problems.</p>	<p>■ Don't incline Energy Recovery Ventilators when removing the unit.</p> <p style="text-align: center;">Otherwise, water remaining inside is likely to drop and wet the furniture or other property.</p> <div style="text-align: center;">  <p>Prohibited</p> </div> <p>● Ask the sales office or the engineering shop to perform the work.</p>
--	--

Features

Main Features

1. Energy saving ventilation
Thanks to efficient recovery of thermal energy lost during Ventilation (load incurred by outside air), you can save an air-conditioning fee.
2. Facility saving
Thanks to a drastic reduction of load incurred by outside air, you can make air-conditioners more compact in parallel with the recovery of thermal energy.
3. Humidity adjusting effect
In a cooling mode, a highly humid open-air is brought near to a dehumidified room atmosphere and then supplied. In a heating mode, a room humidity is transferred to the dry outside air and then supplied.
4. Comfortable and consistent ventilation
Ventilation is available with least possible fluctuation of a room temperature. Since exhaust and air intake are performed simultaneously, a stable ventilation is possible even in a highly airtight room.
5. Sound shield effect
The ducts of the unit and the heat exchange element are characteristic of sound shield effect. Thus, it prevents an outside noise from coming in the unit and also sound inside the unit from going out, so that the office and store environment can be preserved.

Name of Each Part

[Model No.] UTZ-BD025C
 UTZ-BD035C
 UTZ-BD050C

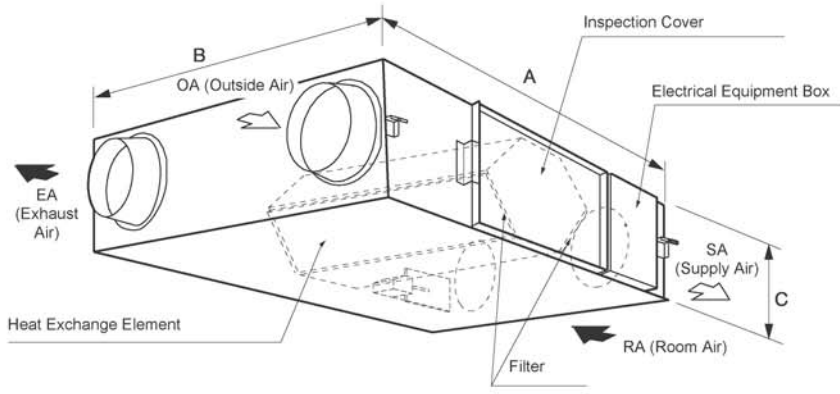

Unit: mm

Model No.	A	B	C
UTZ-BD025C	882	599	270
UTZ-BD035C	1050	804	317
UTZ-BD050C	1090	904	317
UTZ-BD080C	1322	884	388
UTZ-BD100C	1322	1134	388

Note: Dimensions of Ceiling Suspension Fixtures are not included.

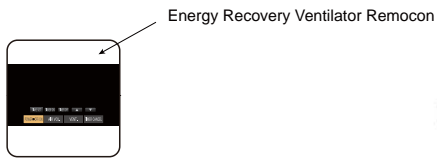

[Model No.] UTZ-BD080C
 UTZ-BD100C

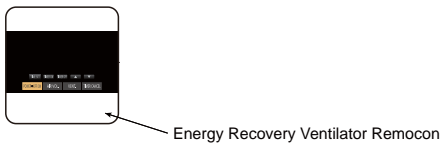
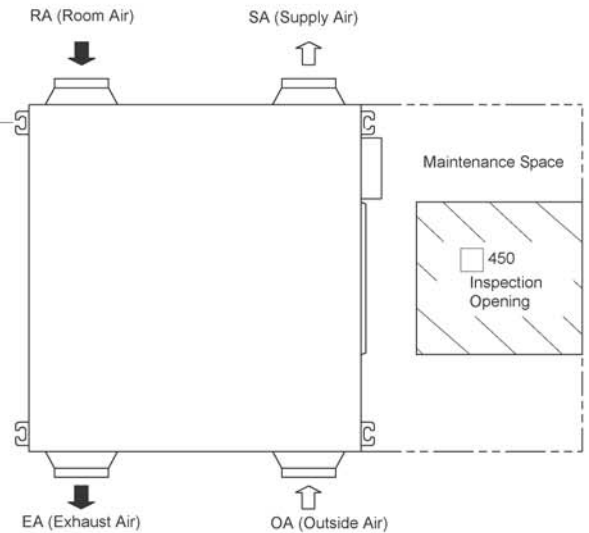
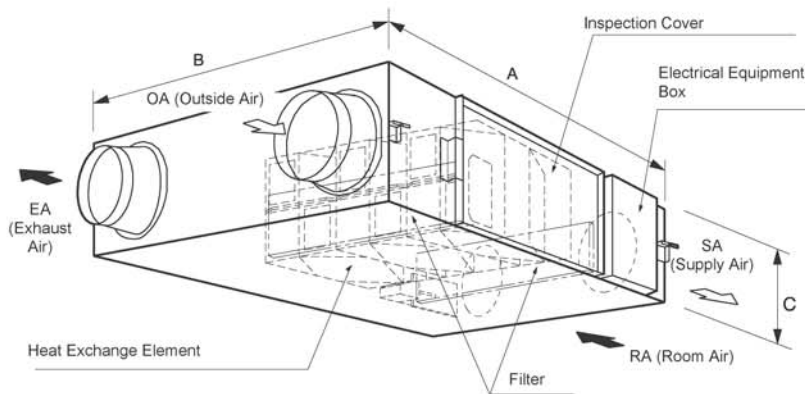

Specific Caution Items

Checking Location of Installation

This Energy Recovery Ventilators have been designed especially for use in offices, conference rooms, etc. Please check to ensure that neither the main unit nor the inlet-outlet grill are installed in any of the following locations.

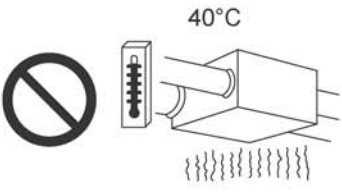
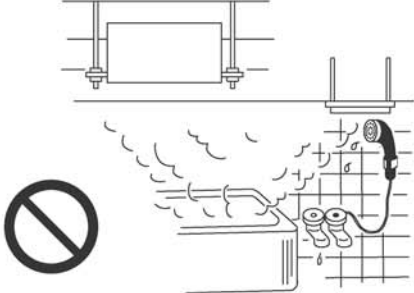
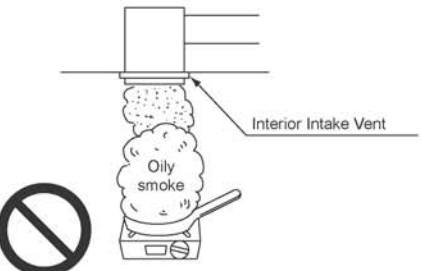
<p>Locations exposed to high temperatures or direct flame. Avoid installing the Energy Recovery Ventilators or the inlet-outlet grill in locations which reach temperatures of 40°C or above. Usage under high temperature conditions may cause distortion of the filter or Heat Exchange Element or motor burn-out.</p> 	<p>Locations with high humidity. Do not install in high humidity locations such as bathrooms. Doing so may cause a breakdown of the unit or an electric shock.</p> 	<p>Locations with large amounts of oily smoke, such as food preparation areas. The unit will become inoperable if the filter or Heat Exchange Element become clogged with oil.</p> 
<p>Make sure that Inspection Opening is provided so that filter and Heat Exchange Element maintenance and periodic spot checks of the unit can be easily carried out. (Refer to the Model Installation for its space)</p>	<p>Do not install the unit in locations such as machinery or chemical plants where it will be exposed to noxious gases containing acids, alkali, organic solvents, paint fumes, etc., to gases containing corrosive ingredients, or where dust or oil mist will be produced.</p>	

If there are any problems concerning the location or installation of the unit, please consult either store from which it was purchased or the agent who installed it.

When Using

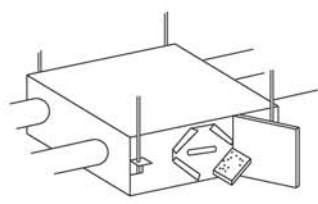
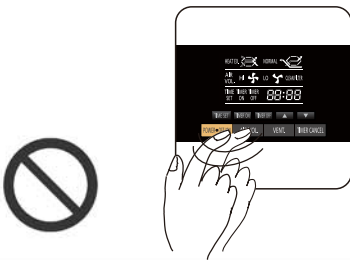
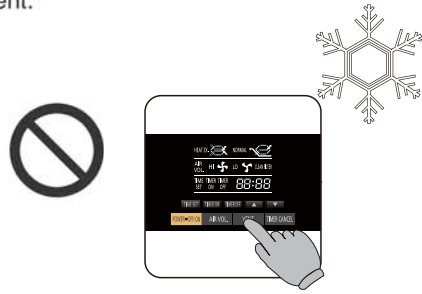
<p>Always be sure to use a filter. Failure to do so may cause dust and dirt to build up on the heat exchange element, lowering its efficiency and rendering it inoperable.</p> 	<p>Operate the Energy Recovery Ventilator Remocon with certainty. In particular, suddenly turning the switch on and off will not only cause improper operation of the unit, but will also affect the relay inside the switch, and may damage it.</p> 	<p>Never operate the on "Normal ventilation" during the winter when the room is being heated, as this will cause condensation to form inside the unit and in the inlet-outlet vent.</p> 
--	--	---

Model Installation

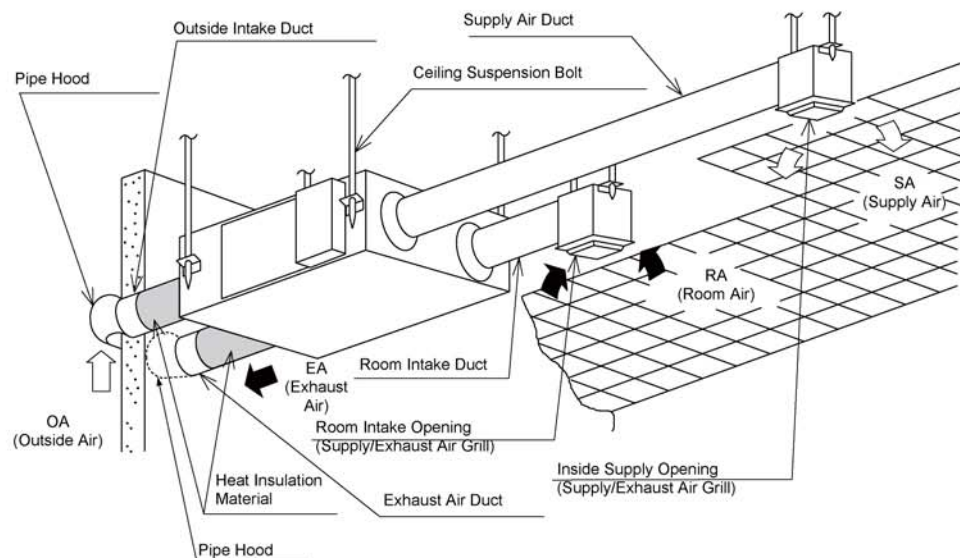

Note that when installing a unit body upside down, its printed indication is in a reversed position.

Method of Use

For detail, please refer to the "Energy Recovery Ventilator Remocon" manual.

After-sales Service

■ Request for Spot Checks

To ensure safe, correct usage, we suggest that you consider a maintenance contract. For details, inquire at the store where you bought your unit, or at the agent which installed it.

■ If You Think It's Broken

Examine the unit as shown in the table below, and if you find any irregularities, shut it off immediately and contact the store where you bought your unit or the agent who installed it to request servicing (or consultation).

Symptom	Where to look
<ul style="list-style-type: none">● No activity, even when the switch is on.● No air comes out.	<ul style="list-style-type: none">● Is the fuse blown or the breaker tripped?● Is the power out?● Check whether or not there is dust on the filters and the Heat Exchange Element. (Clean it according to the Maintenance Manual.)

Specifications

Model No.	UTZ-BD025C					
Item						
Power Source	220-240V~ 50Hz					
Ventilation Mode	Heat Exchange Ventilation			Normal Ventilation		
Notch	(Extra high)	High	Low	(Extra high)	High	Low
Input (W)	112-128	108-123	87-96	112-128	108-123	87-96
Air Volume (m ³ /h)	250	250	190	250	250	190
External Static Pressure (Pa)	105	95	45	105	95	45
Noise (dB)	30.0-31.5	29.5-30.5	23.5-26.5	30.0-31.5	29.5-30.5	23.5-26.5
Temperature Exchange Efficiency(%)	75	75	77	—	—	—
Dimensions(mm)	Width 882 ×Depth 599×Height 270					
Weight (kg)	29					

Model No.	UTZ-BD035C					
Item						
Power Source	220-240V~ 50Hz					
Ventilation Mode	Heat Exchange Ventilation			Normal Ventilation		
Notch	(Extra high)	High	Low	(Extra high)	High	Low
Input (W)	182-190	178-185	175-168	182-190	178-185	175-168
Air Volume (m ³ /h)	350	350	240	350	350	240
External Static Pressure (Pa)	140	60	45	140	60	45
Noise (dB)	32.5-33.0	30.5-31.0	22.5-25.5	32.5-33.0	30.5-31.0	22.5-25.5
Temperature Exchange Efficiency(%)	75	75	78	—	—	—
Dimensions(mm)	Width 1050 ×Depth 804×Height 317					
Weight (kg)	49					

Model No.	UTZ-BD050C					
Item						
Power Source	220-240V~ 50Hz					
Ventilation Mode	Heat Exchange Ventilation			Normal Ventilation		
Notch	(Extra high)	High	Low	(Extra high)	High	Low
Input (W)	263-289	204-225	165-185	263-289	204-225	165-185
Air Volume (m ³ /h)	500	500	440	500	500	440
External Static Pressure (Pa)	120	60	35	120	60	35
Noise (dB)	36.5-37.5	34.5-35.5	31.0-32.5	37.5-38.5	37.0-38.0	31.0-32.5
Temperature Exchange Efficiency(%)	75	75	76	—	—	—
Dimensions(mm)	Width 1090 ×Depth 904×Height 317					
Weight (kg)	57					

Model No.	UTZ-BD080C					
Item						
Power Source	220-240V~ 50Hz					
Ventilation Mode	Heat Exchange Ventilation			Normal Ventilation		
Notch	(Extra high)	High	Low	(Extra high)	High	Low
Input (W)	387-418	360-378	293-295	387-418	360-378	293-295
Air Volume (m ³ /h)	800	800	630	800	800	630
External Static Pressure (Pa)	140	110	55	140	110	55
Noise (dB)	37.0-37.5	36.5-37.0	33.5-34.5	37.0-37.5	36.5-37.0	33.5-34.5
Temperature Exchange Efficiency(%)	75	75	76	—	—	—
Dimensions(mm)	Width 1322 ×Depth 884×Height 388					
Weight (kg)	71					

Model No.	UTZ-BD100C					
Item						
Power Source	220-240V~ 50Hz					
Ventilation Mode	Heat Exchange Ventilation			Normal Ventilation		
Notch	(Extra high)	High	Low	(Extra high)	High	Low
Input (W)	437-464	416-432	301-311	437-464	416-432	301-311
Air Volume (m ³ /h)	1000	1000	700	1000	1000	700
External Static Pressure (Pa)	105	80	75	105	80	75
Noise (dB)	37.5-38.5	37.0-37.5	33.5-34.5	39.5-40.5	39.0-39.5	35.5-36.5
Temperature Exchange Efficiency(%)	75	75	79	—	—	—
Dimensions(mm)	Width 1322 ×Depth 1134×Height 388					
Weight (kg)	83					

(Note) The ratings mentioned above shows the values under the external static pressure.

(Only the noise level shows the value under the external static pressure: 0Pa)

Noise Level shall be measured 1.5 m below the center of the unit. (It shall be measured at the acoustic room.)

FUJITSU GENERAL LIMITED

Printed in China
Gedruckt in China
Imprimé en Chine
Impreso en China
Stampato in Cina
Impresso na China

25ZDY8RFG0853 P0917-0